



This is a digital copy of a book that was preserved for generations on library shelves before it was carefully scanned by Google as part of a project to make the world's books discoverable online.

It has survived long enough for the copyright to expire and the book to enter the public domain. A public domain book is one that was never subject to copyright or whose legal copyright term has expired. Whether a book is in the public domain may vary country to country. Public domain books are our gateways to the past, representing a wealth of history, culture and knowledge that's often difficult to discover.

Marks, notations and other marginalia present in the original volume will appear in this file - a reminder of this book's long journey from the publisher to a library and finally to you.

Usage guidelines

Google is proud to partner with libraries to digitize public domain materials and make them widely accessible. Public domain books belong to the public and we are merely their custodians. Nevertheless, this work is expensive, so in order to keep providing this resource, we have taken steps to prevent abuse by commercial parties, including placing technical restrictions on automated querying.

We also ask that you:

- + *Make non-commercial use of the files* We designed Google Book Search for use by individuals, and we request that you use these files for personal, non-commercial purposes.
- + *Refrain from automated querying* Do not send automated queries of any sort to Google's system: If you are conducting research on machine translation, optical character recognition or other areas where access to a large amount of text is helpful, please contact us. We encourage the use of public domain materials for these purposes and may be able to help.
- + *Maintain attribution* The Google "watermark" you see on each file is essential for informing people about this project and helping them find additional materials through Google Book Search. Please do not remove it.
- + *Keep it legal* Whatever your use, remember that you are responsible for ensuring that what you are doing is legal. Do not assume that just because we believe a book is in the public domain for users in the United States, that the work is also in the public domain for users in other countries. Whether a book is still in copyright varies from country to country, and we can't offer guidance on whether any specific use of any specific book is allowed. Please do not assume that a book's appearance in Google Book Search means it can be used in any manner anywhere in the world. Copyright infringement liability can be quite severe.

About Google Book Search

Google's mission is to organize the world's information and to make it universally accessible and useful. Google Book Search helps readers discover the world's books while helping authors and publishers reach new audiences. You can search through the full text of this book on the web at <http://books.google.com/>

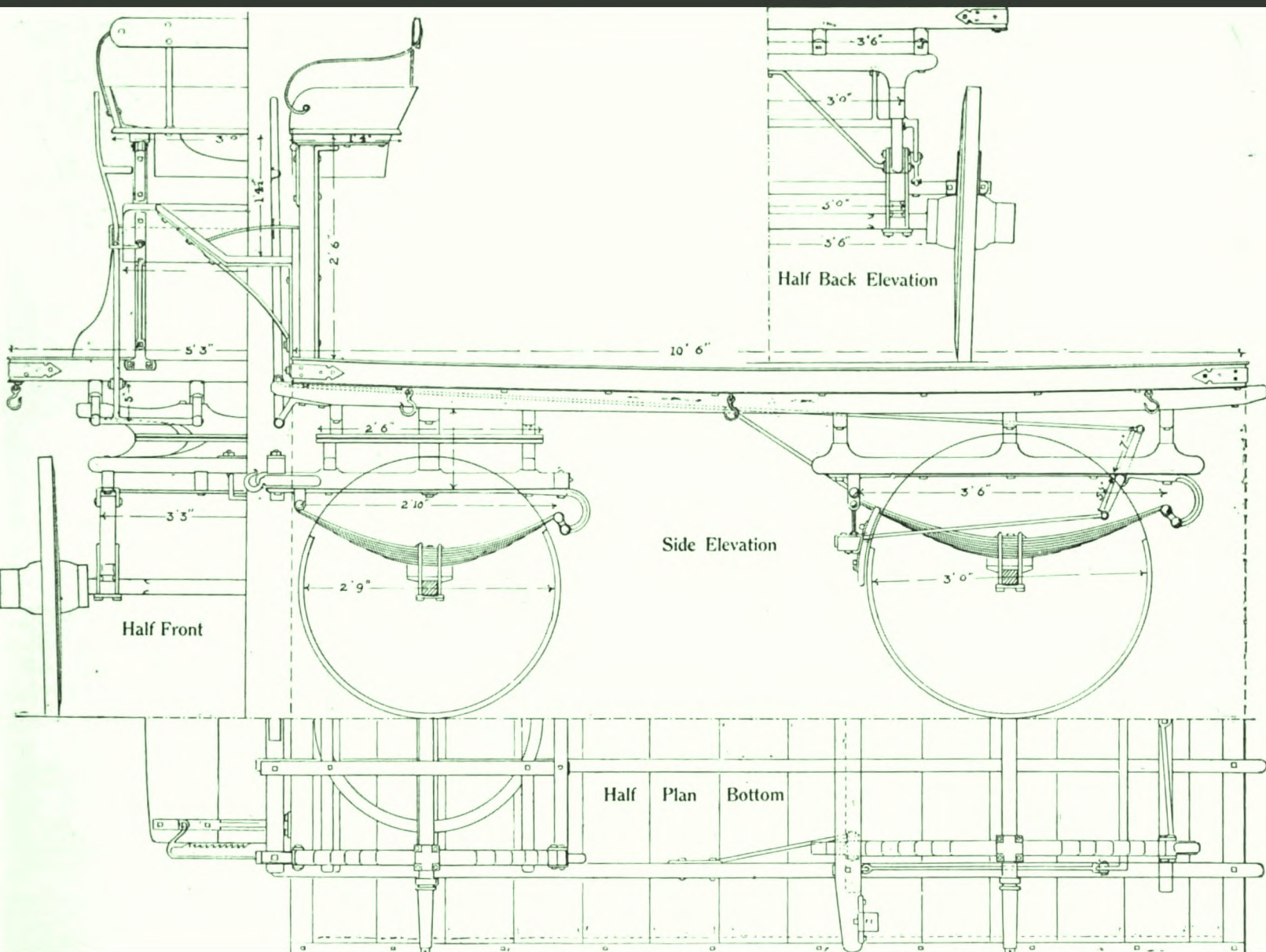

*The automotive
manufacturer*

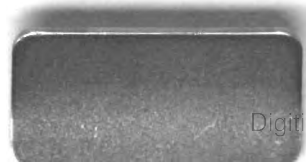

TL
I
.A928
v. 56

The Hub



TRADE NEWS PUBLISHING COMPANY
24-26 MURRAY ST. NEW YORK.

JOHN W. MASURY & SON

Originators of

Superfine Coach and Automobile Colors

Acknowledged the Standard for Fifty Years

AND MANUFACTURERS OF

Fine Carriage and Automobile Varnishes

New York,

Chicago,

Minneapolis,

Kansas City

F. O. PIERCE CO.
NEW YORK,
U. S. A.

Manufacturers of High Class
Pigment Colors from ORIGINAL
FORMULAE. Colors ground in Japan
and other MEDIUMS to meet any
SYSTEM of APPLICATION.

AUTOMOBILE PAINTING

Our Automobile Color Book, showing latest shades for this class of work,
mailed upon application

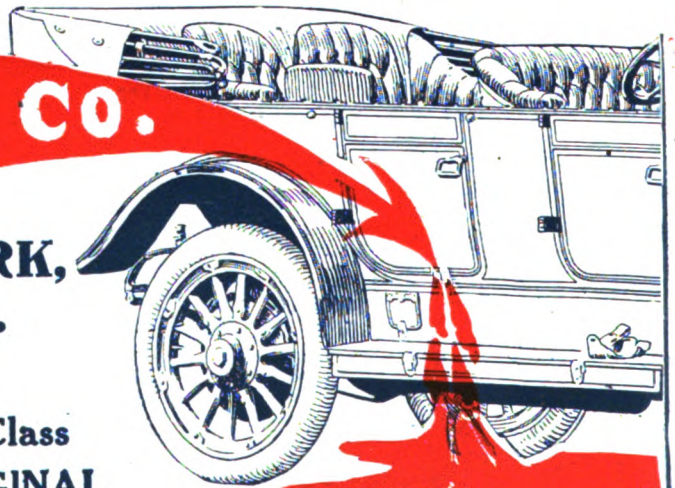

UZATONA
RED

SHERWIN-WILLIAMS VEHICLE FINISHES

A PRODUCT FOR EVERY PURPOSE, PRODUCING DISTINCTIVE RESULTS

S-W METAL PRIMERS S-W BODY AND GEAR UNDERCOATINGS

S-W Q. D. COLORS S-W COLOR VARNISHES

S-W FINISHING VARNISHES

EFFICIENT IN QUALITY AND UNIFORMITY

The SHERWIN-WILLIAMS Co.

CLEVELAND

CHICAGO

NEWARK

MONTREAL

LONDON, ENG.

BENT RIMS

Hickory Second Growth and Forest Hickory
All Grades

OAK—STAR BRAND

SPOKES

Second Growth Hickory—Finished and Club Head

SUITABLE FOR ALL VEHICLES, INCLUDING AUTOMOBILES

VIRGINIA AND NORTH CAROLINA WHEEL CO.

8 Bridge Street, New York City

RICHMOND, VIRGINIA



1902

W I L C O X

FINE

FINISHED

FORGED

Carriage Hardware and Gear Irons

WRITE US FOR CATALOG No. 11B

The D. Wilcox Mfg. Co.

MECHANICSBURG

CUMB. CO., PA.

SHELDON AXLES AND SPRINGS

**For Horse-Drawn and Power-Propelled
Vehicles of All Kinds**

JUST ENOUGH BETTER THAN OTHERS TO BE NOTICEABLE

When you specify "Sheldon" you are not experimenting with experiments, but are getting Axles and Springs with years of manufacturing experience back of them—Axles and Springs that are selected for important work where conditions make reliability supremely important

SHELDON AXLE COMPANY - WILKES-BARRE, PA.

LARGEST AXLE AND SPRING FACTORY IN THE WORLD

PORTER'S BOLT CLIPPERS

"Easy" "New Easy" Allen-Randall



To Cut 5-16, 3-8, 1-2, 5-8, 3-4 Inch.

H. K. PORTER,

EVERETT, MASS.

Richard Eccles Co., Auburn, N.Y.

Manufacturers of

Forgings: Carriage, Wagon, Automobile' Special

Send for Catalogue No. 17.



HEADQUARTERS

For

Automobile, Carriage and Wagon Supplies

LARGEST WAREHOUSES IN PHILADELPHIA

Top Fabrics, Transparent Fibre, Brass Fittings, Forgings, Leather, Cloths, Carpets,
Wheels, Spokes, Felloes, Etc.

Let Us Show You the Goods, or Write Us for Attractive Prices

JACOB GERHAB

157-159 and 158-160-162-164 N. Third St.,
Philadelphia, Pa.

DECALCOMANIE

TRANSFERS FOR ALL PURPOSES

We Carry the Largest and Best Assorted Line of Stock DECALCOMANIE in the World.
Special Designs of All Kinds, Name Plates, Seat Risers, etc., etc.

DECALCOMANIE ADVERTISING SIGNS OF ALL KINDS

No Shop Complete Without Our Catalog. Write for one.

PALM, FECHTELER & CO., 67 Fifth Ave., New York

THE FAIRFIELD RUBBER COMPANY

Manufacturers of

Carriage Cloth, Imitation Leather,
Automobile Cloths, etc.

FAIRFIELD, CONNECTICUT

KEYSTONE BLACK FILLER

MAKES A PERFECT

ROUGHSTUFF

For Automobile Bodies and Parts

It fills the pores of Metal and Wood perfectly. Sandpapers easily and produces a fine, smooth surface that DOES NOT CRACK, SCALE NOR PEEL.

POMEROY & FISCHER, New York
Selling Agents to Vehicle Trade

KEYSTONE PAINT AND FILLER CO., Muncy, Pa.

American Harness and Saddlery Directory

**FOR 1913 IS NOW
ON SALE**

**It is the most accurate
and complete edition
that has been published**

**Trade News
Publishing Company**

24-26 Murray St., New York

THE list of the **WHOLESALE** and **JOBGING TRADE** is so arranged as to make it convenient to separate the association members from those not so recognized.

The **RETAIL HARNESS MAKERS** of the United States and Canada comprise the principal part of the Directory, arranged by State, Town and County, and in the large cities, the street and number is given. Those rating (approximately) over \$1,000 are marked.

A list of **HARNESS DEALERS** as distinguished from retail harness manufacturers, is also given. The value of this list to those who solicit the vehicle, implement, hardware and department stores will be readily appreciated.

THE BUYER'S GUIDE is a valuable as well as unique feature. It contains an alphabetical classification of all the many and various articles made to sell to the trade, and the names of those making the various articles.

A list is also published of Export Commission Merchants, giving the class of merchandise they handle.

**THE PRICE OF THE DI-
RECTORY IS \$4.00,
PAYABLE IN ADVANCE.**

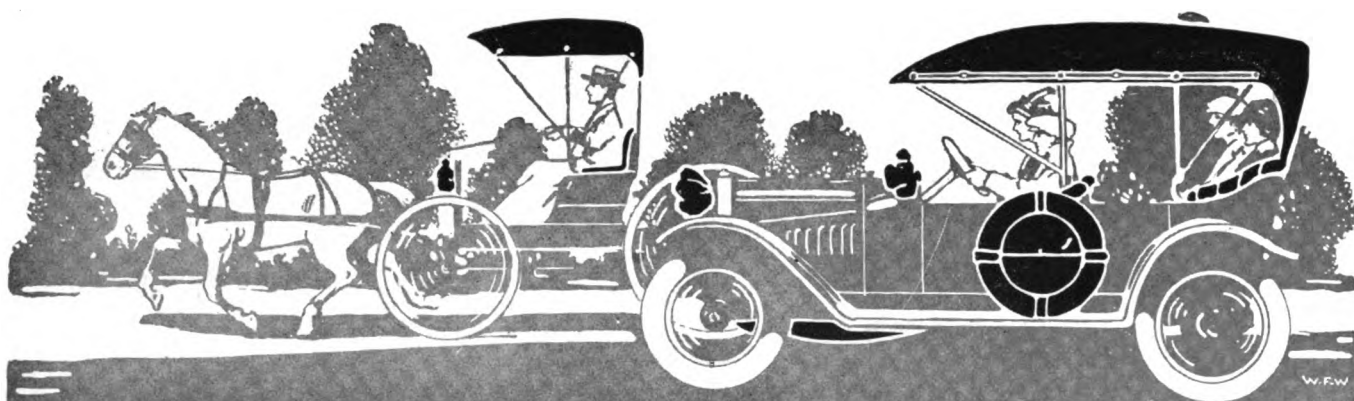

Learn More About The Leading Leather Substitute

Every carriage and automobile manufacturer—every manufacturer of carriage and auto accessories, storm curtains, aprons, lamp covers, tire cases, trunks, etc., should get and examine samples of

MERITAS LEATHER CLOTH

Only by seeing the goods—by testing them—by noting the handsome, durable, non-cracking finish and the fine line of colors can you appreciate the high quality we have attained in the manufacture of a serviceable leather substitute.

There are styles, colors and finishes in MERITAS LEATHER CLOTH suitable for every carriage and auto trimming and upholstery purpose.

It can be had in muslin, duck and drill; dull or glazed; smooth or grained; in black and colors.

Sample book on request—write now and know more about the leading leather substitute.

Write
for
sample
book of
MERITAS
LEATHER CLOTH

NOW

Standard Oil Cloth Co.

320 Broadway, New York

THE TRADE NEWS PUBLISHING CO. OF N. Y. Publishers of THE HUB

J. H. WRIGHT, *President.* G. A. TANNER, *Secretary and Treasurer.*
24-26 MURRAY STREET, NEW YORK.

Other Publications of Trade News Publishing Co.:
HARNESS (monthly).....per year, \$1.00
AMERICAN HARNESS AND SADDLERY
DIRECTORY (annual).....per copy, \$4.00

THE HUB is published monthly in the interest of employers and workmen connected with the manufacture of Carriages, Wagons, Sleighs, Automobiles and the Accessory trades, and also in the interest of Dealers.

Subscription price for the United States, Mexico, Cuba, Porto Rico, Guam, the Philippines, and the Hawaiian Islands, \$2.00, Canada, \$2.50, payable strictly in advance. Single copies, 25 cents. Remittances at risk of subscriber, unless by registered letter, or by draft, check, express or post-office order, payable to the order of TRADE NEWS PUBLISHING Co.

For advertising rates, apply to the Publishers. Advertisements must be acceptable in every respect. Copy for new advertisements must be received by the 25th of the preceding month, and requests to alter or discontinue advertisements must be received before the 12th day of the preceding month to insure attention in the following number. All communications must be accompanied by the full name and address of writer.

FOREIGN REPRESENTATIVES:

FRANCE.—L. Dupont, publisher of *Le Guide des Carrossiers*, 78 Rue Boissiere, Paris. Subscription price, 15 francs, postpaid.

GERMANY.—Gustave Miesen, Bohn a Rh. Subscription price, 12 marks, postpaid

ENGLAND.—Thomas Mattison, "Floriana," Hillside Avenue, Bitterne Park, Southampton. Subscription price, 12 shillings, postpaid.

Entered in the New York Post Office as Second-class Matter.

The Dealer's Influence

A daily newspaper of large and influential circulation set out to find out who it was, what class, that influenced sales the most; hence who it was, what class of traders, it was best to cultivate.

It is stated that thousands of inquiries were broadcasted, and thousands of answers were received. The tabulation at last showed this:

Fifty-five (55%) per cent. of sales were influenced by the dealer.

Thirty-six (36%) per cent. were influenced by addressing the consumer directly, and

Six (6%) were influenced by the recommendation of friends.

These are very interesting results for the buggy builder to think about. They will tend to confirm him in his belief that his general policy of relying upon the dealer has been the proven correct policy, if the figures above given are a true index, and it is fair to presume they are.

They would, also, tend to show that a propaganda by the collective buggy builder to bring influence to bear on the buggy user, so well thought of very recently in

the trade, is not so good by nineteen per cent. as the plan at present in vogue, which is the reliance on the good offices of the dealers to work off the product.

We don't want to be mistaken in supposing that we present two alternatives, a dealer's aid, or a consumer's direct order. This is not the point. Even those buggy factories that run the larger part of their product to the consumer via the catalogue house, find in that quarter their dealer.

The difference is it is not a recognized dealer proposition by the trade at large.

It would be very interesting and instructive, too, if we could learn somewhat about the methods put into practice by the various buggy builders to coax the dealer trade.

In general, of course, there are but the two methods of salesman and catalogue, separately or in combination.

The application of these two plans must differ as much as men themselves differ.

If it were possible to learn and then describe, without great expense to the investigator, what all these methods were, and then correlate them so as to deduce a general plan or principle of working, in the nature of a standardization of effort, it seems to us something of value would result.

A study of the psychology of the crowd leads to the knowledge that a crowd is swayed by a basic feeling whose base is always sentiment.

It is a crude sentiment, unreasoning of course, but in the main springing from a truth of general application.

To learn how to sway the dealer (who is the crowd so far as the buggy builder is concerned), it is only necessary to learn what is this underlying power, and then "work" it just as the politician works all of us when he has the skill to touch the similar kind of chord whose vibrations set us all shouting like a pack baying the moon—and with about as much of reason.

Signs of the Times

These signs point very plainly in the cities to the rebirth of the "establishment" that has become dead, buried, and obituaried by all and particular these many years.

We don't pretend to philosophize on the cause of it all; perhaps we would cut a sorry figure trying to do so, but we can recognize a condition when it confronts us.

The fine team, the men on the box, the appointments,

and even the vehicle are much in evidence, and miladi is the very glass of fashion within, of course.

Occasionally we see a fainter, more effaced effort, if we can so describe the sight. It is the shabbier attempt at the same thing. But the main point to note is the fact that it is a militant attempt that will sure grow more perfect with time.

This has been developing for some three seasons, very pale and ineffective at first, but getting more and more into bloom with each season, until now it is no longer a rare sight to see the well-appointed horse establishment on the streets.

We ascribe it to fashion, the desire to be exclusive. The automobile is common now. The mud sill can own a Ford and that is horrific to the person whose sensibilities have been attuned to the fine point of the money caste.

The next stage, soon to follow, will be the horrible discovery by the social climbers that an automobile is no badge of distinction, no birth mark of caste. And then there will be quite some crowding to add the horsed vehicle to the "establishment," and by such act edge away from the vulgar common herd who have mistaken the trend, and taken a cheap Ford cut to the ways of the elect.

This, we take it, is the common movement of fashion, vogue, society—all words to express that desire for distinction by segregation from those others whose real function is to admire, envy and futilely imitate.

But fine horses and carriages are in evidence.

If

If it should come true that the policy of watchful waiting was finally transformed into wasteful baiting, and great bodies of men should be called into camps, those who make farm wagons in the piping times of peace would certainly have to hustle to find timber enough to cut up and fashion into army transport wagons, and with U. S. as the customer, there could be no doubtful or uncollectable accounts.

We don't know where the buggy maker would come in, but he has had a better innings than the wagon maker, so the law of average would tend to even up prospects.

Job Lots

We notice that there is a job lot of \$100,000 in motor cars, "latest pattern brand new British-built standard cars," the announcement says, and "any reasonable offer will be accepted." The advertiser is the well known Friswells, one of the big auction marts of the English metropolis. This is the first announcement of the kind we have ever noticed.

SOUTH AMERICA AS AN EXPORT FIELD

In the contest for the trade of South America three nations, England, Germany and the United States, are the great competitors according to a publication "South America as an

Export Field," just issued by the Bureau of Foreign and Domestic Commerce of the United States Department of Commerce. Germany and England both lead the United States, the former having in 1912 about \$177,100,000 of the import trade and the latter \$275,400,000 as compared with \$152,900,000 of imports supplied by the United States. Several causes have contributed to this lead of the two European countries but the chief one is that both have been on the ground and working for the trade for many years. The exporters of the United States have made serious efforts to enter the market only in the last four or five years. The very large amount of British capital invested in all parts of South America has also been an important factor in promoting British trade, while the German thoroughness in matter of detail and the German banks have served to build up an enormous German import trade.

The publication mentioned gives a short survey of the geographical, economic and commercial features of the countries of South America, and is intended to serve as a basis of study of the markets there by prospective American exporters. The latest available statistics of foreign commerce of each country are given in the monograph and the proportion of the imports supplied by the three leading countries, England, Germany and the United States, in recent years is set forth. It should prove of interest to all business men whose attention has been turned toward the southern continent as a field for future trade promotion.

A CORRECTION

In March, under "You Auto Read These Facts," we published an article sent us by a subscriber, and credited to the Philadelphia Record.

It appears that the matter was in the Record in its February 22 issue, but as a part of an announcement in the advertising pages emanating from the Bull's Head Horse Bazaar, so we actually ought to have given this active concern credit for reportorial enterprise that we assumed the Record was equal to.

As the article reported a complete breakdown of the commercial gas and electric trucks as a result of a severe storm, probably the Record reporter glimpsed the Record's auto advertising in the Sunday issue and concluded "there's a reason."

THE LAZY DAY

Well, this has been a splendid and a very perfect day;
I took my work and worries and I threw them all away—
I took the work I ought to do and looked it in the eye
And said: "You get a holiday, old task of mine, good-bye.
I hope you have a pleasant time wherever you may roam,
Now, don't get lost, but just the same you needn't hurry home."

My work stood begging at my side, my elbow Duty nudged.
But with a stern and haughty heart I never even budged.
I stretched myself upon my back within the hammock here
And swung and swung and let my soul get bubbling full of cheer.

My work went galley-west, I guess—I know it isn't done—
But, friend, to have a Lazy Day is certainly some fun.

And all the things I worry for and of—the pesky things!
I gave them all to understand they might as well take wings.
I'd worried over them in a most faithful earnest way,
But worry hasn't any place in any lazy day.
Some little worries fretted up and sighed: "What can you do?"
I blew them all to smithereens with one intense "Pooh! Pooh!"

So here I am, with work undone, unworried worries, too.
And still the grass is nice and green, the sky is nice and blue.
The world is rolling right along, no doubt the stars will gleam—
I guess I'll linger here a while and muse and doze and dream.
My friend, when Work is fighting you and Worry wants to stay,
Just thrown the whole thing to one side and have a Lazy Day.

—Wilbur D. Nesbit, in "Collier's."

Foreign Styles, Landaus

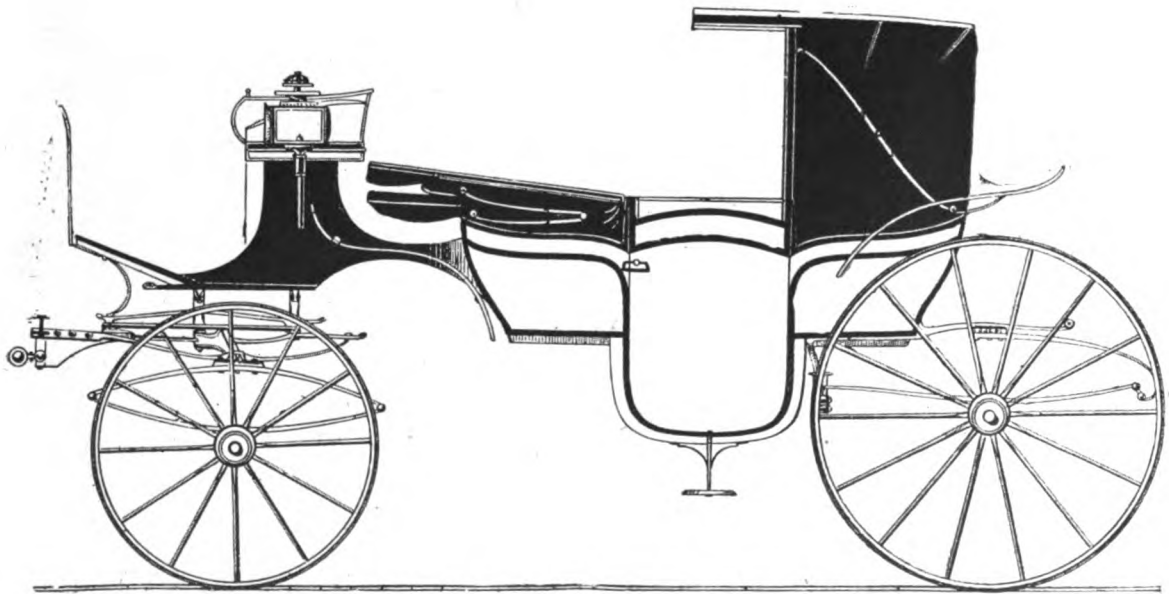
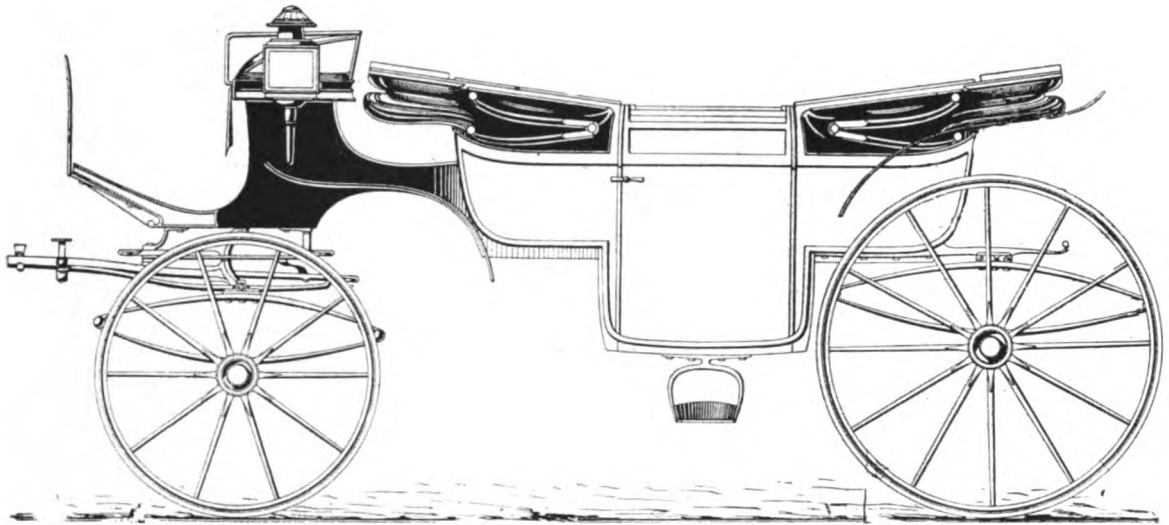

Foreign Styles, Victorias

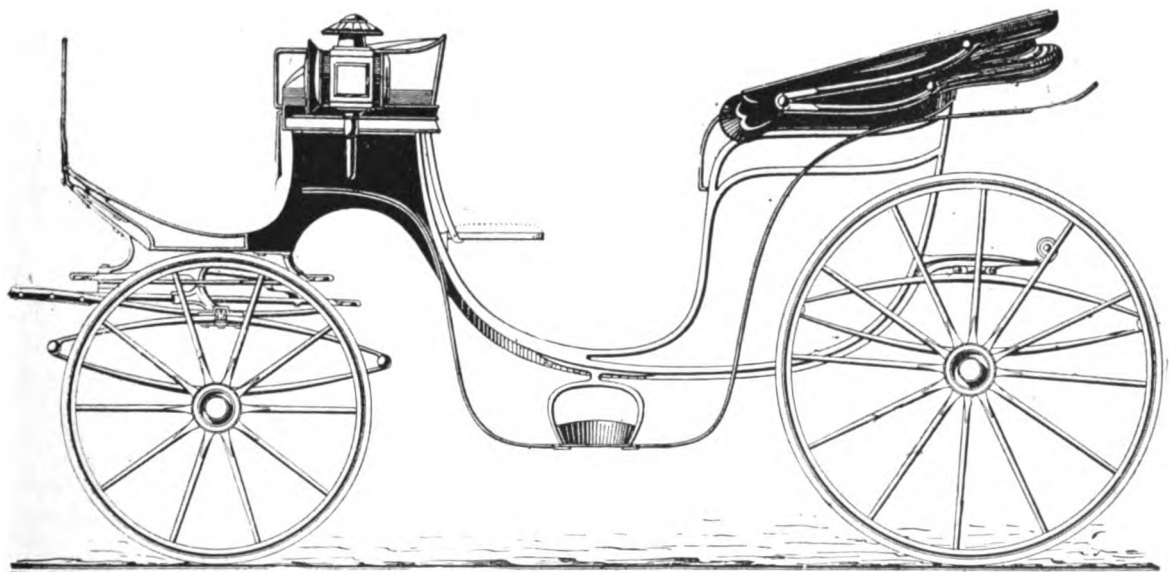
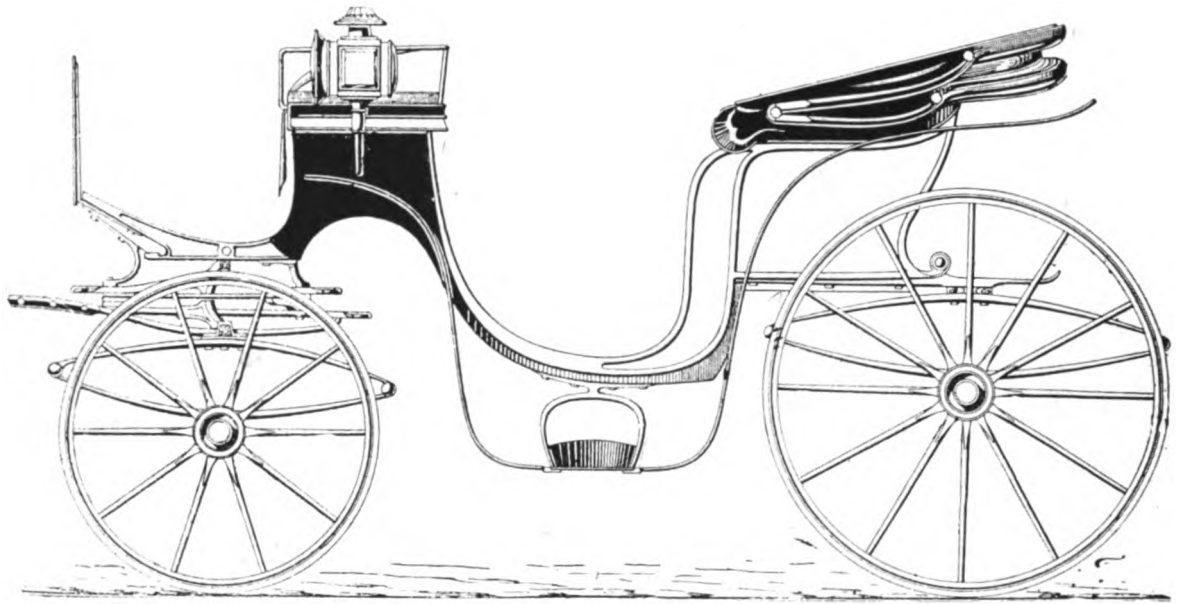

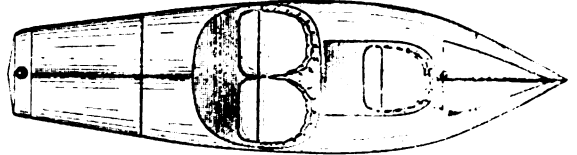
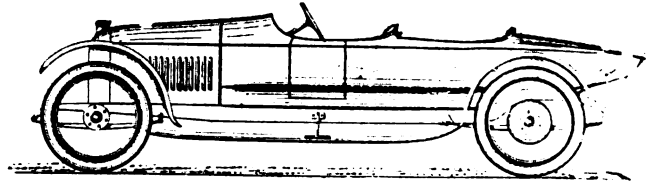
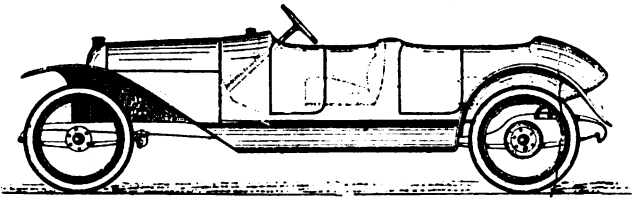

Torpédo Lucas

Torpédo Girard et Delacouture

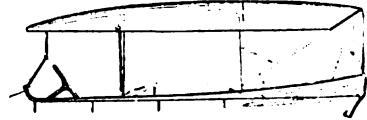
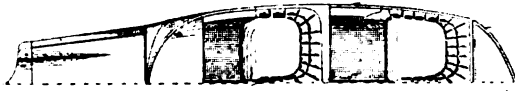
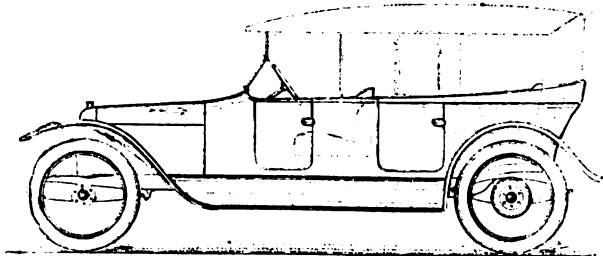
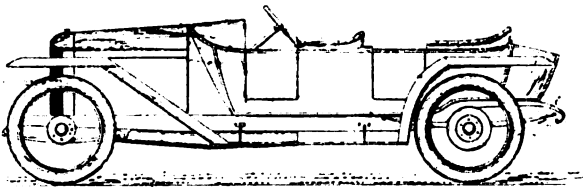

Torpédo Bateau Keliner, salon de l'Olympia

Torpédo Austin, salon de l'Olympia

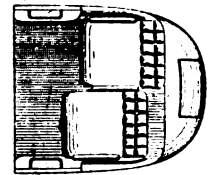
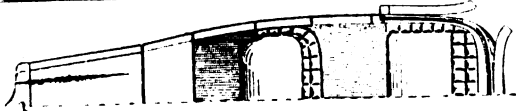
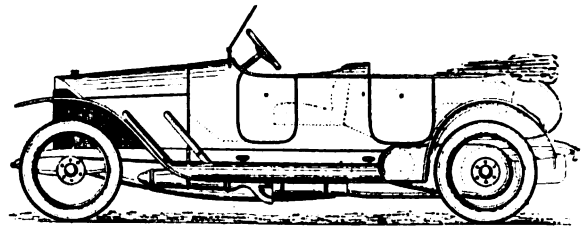
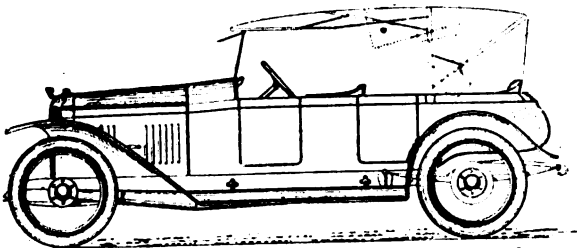

Torpédo Griffault, stand Turcat-Méry

Torpédo Belvallette, stand Mercédès

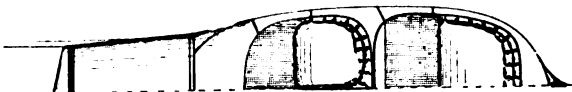
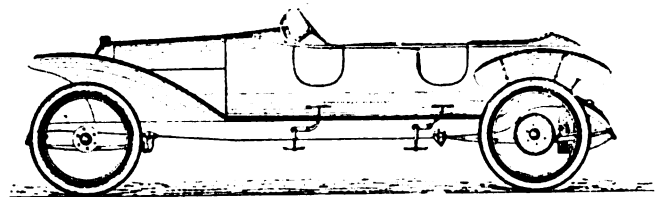
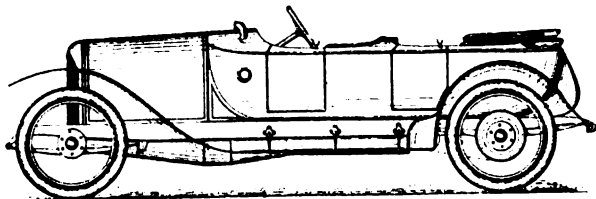

Torpédo Rothschild, stand Gobron

Torpédo Henri Labourdette

RECENT FOREIGN TOURING BODY STYLES

SIDE VIEWS AND SEATING PLANS

STORY OF ALUMINUM

When Napoleon III presented his son, the Dauphin of France, with an aluminum rattle, he gave him an object which at that time, 1856, was worth approximately \$1,000. Today, if it were not for its historical value, the rattle could be purchased for 25 cents. The Napoleon rattle was one of the first objects to be made from aluminum which was then sold at \$100 a pound in spite of the fact that it forms 8 per cent. of the earth's crust, as metallurgists today assert.

Aluminum is found everywhere. Common Portland cement is 5 per cent. aluminum, and in common earth aluminum is abundant, being in combination with silicates and other impurities. As a metal aluminum first existed in 1845, when the German chemist, Frederick Woehler, succeeded in separating it into a globular form. At the Paris show in 1878 it was sold in sheet, wire, foil and ingot forms at a price of \$16 per pound.

Its Early Manufacture

In 1884, Charles M. Hall, then a student in Oberlin University, discovered a method of electrically extracting aluminum from the ores in which it is mingled with various impurities. This discovery worked out so well that in 1889 the Pittsburgh Reduction Co. was organized and put out a product that was over 98 per cent. pure aluminum at a price of 65 cents a pound. At that time three men were employed in the company and the output for the year for the entire aluminum industry was 47,468 pounds. In 1913 the company founded by Mr. Hall employed 5,000 men and produced the greater part of the 70,000,000 pounds manufactured in the United States. His company was then and is still known as the Aluminum Co. of America. The aluminum now produced is more than 99 per cent. pure.

Aluminum is the lightest commercial metal. It is three times as heavy, volume for volume, as distilled water, and as compared to gold, the heaviest metal, aluminum is about $\frac{1}{8}$ its weight. A cubic foot of gold weighs 1,200 pounds, a cubic foot of aluminum 166 pounds, and a cubic foot of water 62.5 pounds.

The Lightest Metal

Lead, the heaviest commercial metal used in large quantities, weighs 709 pounds per cubic foot. Iridium, the heaviest of all metals, weighs 1,396 pounds to the cubic foot, and is more than eight times as heavy as aluminum, although the feather metal, aluminum, has certain alloys which are lighter than pure aluminum. When combined with magnesium, which weighs but two-thirds the amount of aluminum, an alloy called by the trade name magnalium is formed which weighs but eight-tenths as much as aluminum.

Considering its lightness it would be thought that aluminum would be at the foot of the list as regards strength, but this is not true. When measured pound for pound it is as strong as the mild steel used for structural purposes, and on an area basis it has a tensile strength, in ingot form, of 26,800 pounds to the square inch, as compared with 60,000 pounds for mild steel, 24,000 for cast iron, 26,000 for bronze, and 115,000 pounds for spring steel.

Aluminum melts at 657 degrees centigrade, silver at 961, copper at 1,084, cast iron at 1,050, and mild steel at 1,475.

Aluminum expands .0000231 foot for every foot of its length for each degree increase in temperature, and it is this factor that has rendered its use for pistons so difficult, because the coefficient of cast iron is but .0000121.

A Good Heat Conductor

Aluminum is a good conductor of heat, carrying away about three times the quantity of iron and a third as much as silver, which is the best conductor. It weighs 2.56 times as much as distilled water, one third as much as iron, and in its commonest alloy, No. 12, it has a specific gravity of 2.82.

The principal aluminum producing countries are the United

States, France, United Kingdom, Italy and India. The best ore is known as Bauxite, so called from Les Baux, a city in France, where it was first found in abundance.

In the United States the principal mines are in Arkansas, Tennessee, Georgia and Alabama. Bauxite, mined in Arkansas, contains about 25 per cent. aluminum. While in its ore it is in the form of aluminum oxide.

In 1908 France was the leader in Bauxite production with 167,991 tons, as compared with 56,127 tons in the United States, and with Great Britain, Italy and India, the other producing countries, not reaching 12,000 tons each. The following year saw the United States take the lead in the production with 129,101 tons to France's 128,099 tons. Since then the United States has increased from 129,000 to 148,000 in 1910, and 153,000 in 1911. The figures are not yet available for 1912 and 1913, but they will doubtless show a steady increase for the United States. These figures on Bauxite only become interpreted when it is remembered that approximately 20 per cent. of this weight of ore becomes metallic aluminum.

The commercial ore, Bauxite, is found as a reddish clay on the earth's surface the same as brick clay. The ore is loosened by black powder blasting and is carried from the mine in small narrow-gauge cars to the nearest railway siding. The ore is not washed, but carried in its natural state from the railroad cars directly into the crushers. It is then kiln-dried under 150 pounds air pressure and, in recent years, by means of natural gas as a fuel.

For the manufacture of metallic aluminum the ores containing most iron are selected. These are sent to the reduction plant, where they are submitted to the process of extracting the metallic aluminum.

The process used commercially in this country is that invented by Charles M. Hall, of the Aluminum Co. of America, which has immense plants at Niagara Falls and other cities. As the process is an electro-chemical one, the power of the falls is used to furnish the electro-motive force.

Description of the Hall Process

The principle used for extracting aluminum by the Hall process is the electrolysis of the molten mass of alumina, or oxide of aluminum. The apparatus consists of a furnace for keeping the alumina in a molten state, a crucible for holding the alumina and negative and positive electrodes. By the addition to the alumina of aluminum-sodium double fluoride the molten mass is transformed into a conductor of electricity, or an electrolyte. When a current of electricity is passed through the electrolyte between the negative and positive electrodes, the electrolyte is decomposed and one of the resulting products is aluminum, which drops to the bottom of the vessel.

In 1913 there were 70,000,000 pounds of metallic aluminum produced in the United States. In 1883 the output was 83 pounds. The 1,000,000-pound mark was passed in 1896, during which year 1,300,000 pounds were produced. During the following years the production rose to 4,000,000 pounds. Since then it has risen rapidly, remaining stationary during 1900 and 1901, when the production was 7,150,000 pounds. From 1883 to 1913, inclusive, the production has totaled 375,358,779 pounds. Aluminum can be used in many different forms.

Automobile Work 90 Per Cent. Castings

In the automobile industry aluminum has an extensive use, about 90 per cent. being in the form of castings. The other 10 per cent. is in sheet form or in small quantities in the bar. Taking one make of car for example, 35 parts are of aluminum. Of this number 30 are castings, four are of sheet aluminum, and one in bar form. This company during the year of 1913 used 203,000 pounds of aluminum and has been using this metal since 1902. The same parts approximately for which aluminum was used at that time are composed of it now. The biggest aluminum pieces in the car are the crank case, gearset housing,

rear axle housing cover, universal joint covers, fan, cowl, oil pan, bonnet sides, and the various caps and housings throughout the assembly.

The big production companies require an enormous amount of aluminum, the Overland company requiring alone 3,500,000 pounds annually; Jeffery, 1,000,000; Locomobile, 200,000, and the Haynes, Winton, Franklin, Peerless and Mitchell use about 300,000 pounds each. These companies generally use a copper alloy and employ it for any part where lightness is desired and where the strength is sufficient to fulfill the needs with a good margin of safety. For housings, brackets, piping, pumps, etc., it has met with practically universal favor. Magnalium and McAdamite are two alloys which combine the light qualities of aluminum with an amazing strength and which have been suggested for pistons.

Aluminum is a difficult metal to handle for those who have not by experience mastered its many phases, is the opinion of J. E. Schipper, the writer of this article in *Automobile*. For instance, a difference of 50 deg. Fahr. in the pouring temperature of the metal will change the tensile strength of the resulting casting by 500 pounds to the square inch. Many other difficulties enter into the casting of aluminum, not the least of which is the shrinkage, which amounts to .203 inch to the foot on pure aluminum and on the casting alloys generally used to .156 inch to the foot. Cast iron has a shrinkage of .125 inch per foot.

Is Difficult to Manipulate

The machining of aluminum is difficult. It is a great tool heater, and in that way very much resembles copper. The work has to be carried on under a continual stream of cooling or lubricating agent, the most popular of which are a mixture of lard oil and water, or kerosene.

The cost of aluminum castings is little if any more than that of iron castings. While in the raw casting the iron one will be cheaper, but the handling of the aluminum through the shop is cheaper than iron. It is cheaper than bronze, piece for piece, and when the weight is taken into consideration, the adaptability to casting, rolling or spinning more than compensates for the difference in price.

About 80 per cent. of the cars made by American manufacturers have aluminum crank cases and about the same proportion holds true for gear cases. The demand is increasing and it is now being used in many small parts such as the connecting links for brake system, spark and throttle connections, etc.

Aluminum die castings are now on a sound commercial basis. Spark and throttle levers, brake rod devices, magneto bases, etc., are now die cast.

Die-Casting Methods

In die casting the metal is pressed into the steel moulds under a pressure of about 400 pounds to the square inch. The dies are closed by means of levers and the cores can run in any direction. Holes which are absolutely square can be cast into the metal, whereas if machining were resorted to an expensive broaching process would be necessary.

The advantage of die casting is the ability to make finished shapes to within .005 inch and thereby to eliminate a large amount of machining. It is this ability to cut the machining cost which enables the die-casting process to compete with the sand casting.

Aluminum combines with iron impurities and offers difficulties in the way of die casting. This is due to the fact that aluminum has a marked affinity for iron, and as the dies are made of machinery steel, there is a tendency for the aluminum to cling to the die when carried at its full molten state, 1,200 deg. Fahr.

Aluminum will combine readily with any of the common metals, with the exception of lead. The principal alloys which form useful combination with aluminum are copper, chromium, tungsten, titanium, molybdenum, zinc, bismuth, nickel, cadmium, magnesium, manganese, tin and antimony. Those containing

copper and zinc are used most in the automobile industry. All the alloys are harder than pure aluminum.

When working with aluminum the processes used with other metals must be forgotten. Two castings may look exactly alike to the eye, and yet one may have a tensile strength of 22,000 pounds and the other will have barely 15,000 pounds tensile strength. Aluminum will weld satisfactorily with the oxy-acetylene and the oxy-air processes, but to solder it requires considerable knowledge of its peculiarities. Many companies that are handling large quantities of aluminum daily state that it cannot be soldered. Others see no difficulty in doing the work. The requisites for a successful soldering operation are that the aluminum must be free from grease or other foreign matter and the solder must be correctly prepared or else some of its ingredients are sure to be burned. Most cases of failure in aluminum soldering, however, can be laid at the door of the operator.

TRADE DIRECTORY OF SOUTH AMERICA

A complete revision and detailed classification of the names of South American importers and merchants, made by the American consular officers in co-operation with the Bureau of Foreign and Domestic Commerce, has been published as a section of a new edition of the *World Trade Directory*. The lists have been brought up to date and are presented in uniform style, with a finding index.

A new feature is the listing, so far as the information could be obtained, of (1) the American and other foreign agents of South American importing firms, and (2) of the names of the parent firms of branch houses located in various South American cities.

The directory does not aim to include the names of South American exporters, nor are the names of manufacturers given, except those who are, or seem likely to become, purchasers of American materials or merchandise. The publication is a directory of South American buyers for use by exporters and manufacturers in the United States.

The directory is in octavo form, bound in buckram, and is sold at \$1 a copy, to cover partially the cost of printing. Those desiring one or more copies of this directory should apply to the Bureau of Foreign and Domestic Commerce, Washington, for the necessary order blank.

DEALER'S CREDITS

If there were no credit extended there would be no collections to make. In analyzing credits we find that if the credit is extended there must be a business transaction of some nature.

Too many dealers do not realize, or at least do not take it seriously enough, that, when a credit sale is made, a collection must necessarily follow. Make no promises or guarantees that you do not expect to make good and that you cannot make good without depreciating yourself or your profits. Many of our troubles on collections commence when the sale is made.

Have a distinct understanding with the customer when the sale is made that the goods have changed hands and that, when you have his cash or note, it belongs to you and the goods are his. Convince him without question that the goods are what he wants or you have only half made the sale, and many times you will have to finish the other half at settlement time either by taking the goods back or by compromising settlement. Whichever it be it is disastrous to your business and especially to your standing in the community as a business man.

Have a distinct understanding with the customer just when he is to settle. Do not be afraid to talk straight to the customer that is asking for credit. It is he that you are accommodating and not yourself. Be sure that you leave with him that impression. If you are not keeping your credit trade feeling in that attitude, you are on the wrong line.

BUSINESS SCIENCE

We have made use here of parts of an article compiled by F. P. Stockbridge, telling of the wonders performed by the late Dr. Duncan, and now continued by his successor, Dr. Bacon.

It is the story of industrial research for the benefit of business and the great as well as curious money-making stunts already of record. It shows how chemistry is the real handmaiden of business, but heretofore (in this land, especially) not well recognized. It is a tale of the romance of trade, and should interest all who work.

In a little wooden building on the grounds of the University of Pittsburgh, 36 young chemists are working at scientific problems, the solution of which will earn millions of dollars for many industries, and eventually add to the happiness and prosperity of everybody in the world.

The little wooden building is the temporary headquarters of the Mellon Institute of Industrial Research of the University of Pittsburgh. A hundred feet away, the walls are going up for a big fireproof building that will house 70 distinct research laboratories.

"How can we make better bread?" asked a big baking company of the late Prof. Duncan, Director of the Institute. The first step in finding the answer was to put a trained chemist at work in one of the institute's laboratories. The baking company paid him a salary of \$750 a year for two years and offered him a prize of \$2,000 if he found a satisfactory answer. Before he had finished his experiments, another baking company asked the same question. They offered \$4,750 a year for two years and a prize of \$10,000 for any practical results.

And the chemists got results—found not only one answer but a dozen answers—found how to make better bread, while at the same time cutting down the cost of manufacture; found how to make "salt-rising" bread of better quality than the kind grandma used to make; found out, in short, so many interesting and valuable facts about the chemistry of bread making, that the companies which are now utilizing these facts are already saving probably more than \$250,000 a year in the cost of their product and giving their customers better bread than they have ever had. And that was only a beginning of the research into the chemistry of bread at the Mellon Institute.

It is almost safe to predict that the poorest bread sold ten years from now will be better than the best on the market today, and cheaper.

Over in Germany, manufacturers and business men have recognized this direct connection between science and industry for many years, and have been making good use of it. But while the Germans have been going ahead rapidly, American industries have lagged behind. Occasionally an American manufacturer has hired a chemist on about the same basis as he would hire a machine hand, and with about the same expectation of a daily output in return for his wages. But the instances have been as few in America as they have been frequent in Germany where manufacturers have provided adequate laboratory equipment, freedom from restrictions and interference, and reasonable salaries for trained chemists to work out scientifically the vital unsolved problems of a particular industry.

An interesting and inspiring place, this rough building in which science is teaching industry how to transmute base materials into coined gold. Literally from cellar to garret it is crowded with men and women and apparatus, while the odors of ozone, oxides of nitrogen, yeast, petroleum, sulphuric acid and a hundred other gases and chemicals mingle familiarly in the hallways. Thirty-two industrial fellowships have so far been established. The work under many of them has been completed, but that still going on represents an annual expenditure by the industrial interests that have endowed the fellowships of \$102,400.

"We can get money for research easier than we can get men

qualified to do the highest class of research work," said Dr. Duncan, when I talked with him less than a month before his death. "Two Pittsburgh men, A. W. and R. B. Mellon, have given \$250,000 for the new building, \$60,000 for apparatus, \$20,000 for the purchase of a chemical library, and an endowment of \$40,000 a year for general maintenance. This makes it possible to devote every cent that is paid by a manufacturer for research work to the solution of his particular problem. Our only difficulty now is in getting the best men for research work, but we are getting them from every part of the world."

Secrecy is the rule at the Mellon Institute—the protection of the trade secrets of the manufacturers in whose interests the research work is being done, in order that they may reap the benefits of their investments in the fellowships. Yet every contract between an industrial company and the institute contains a provision insuring the eventual publication, after a reasonable lapse of time, of the results obtained, for the benefit of the whole industrial world.

With forty or fifty young chemists working in the same building, each on a different problem and each bound to secrecy as to the exact results he obtains and the methods by which he gets them, it is, of course, essential that a high standard of honor shall prevail throughout the establishment. One of the finest and most inspiring sights at the Mellon Institute is the partition wall in the main office, covered with university pennants. Upon this wall, when he enters the institute to take up research work, each fellow tacks the emblem of his alma mater. It has already become a tradition that in so doing he pledges the honor of his university, not only as to the quality of his work, his enthusiasm and his devotion to it, but by way of an oath to keep his own counsel and never reveal the secrets with which he is intrusted or that he may learn while there.

An interesting illustration of the way in which the best available knowledge of specially trained scientists is utilized is found in the organization of the office and the library of the institution. Here, in addition to the books, is a large staff of stenographers. Instead of wasting days or weeks hunting for a special piece of information which may or may not be contained in one of the volumes, if the facts sought are not readily accessible, letters are written to those scientists in every part of the world who stand foremost on the particular questions involved, and thus the fullest available information is brought to bear on the problems.

Before beginning the work in the laboratory, most of the research fellows familiarize themselves with the problems they are to undertake by spending several weeks, or even months, in the factories where the results of their work are to be applied, thus gaining first-hand knowledge of the manufacturing conditions which must be met. Nor does their research work stop with the achievements of mere laboratory results. These once gained, a "unit plant" is constructed, and the new process tested or the new product manufactured on a scale large enough to demonstrate its commercial applicability.

While nothing that could affect the interests of the supporters of the industrial fellowships may be made public, yet enough was disclosed to me by Prof. Duncan to prove the tremendous value to industry.

"Here is the result of one of our researches," he said, taking from his desk several objects made of what appeared to be vulcanite or hard rubber. "And here is another specimen of the same substance." This was a rod of material that looked exactly like a fine specimen of clear amber. "Both of these substances are the same," he said. "It is a new product, called amberoid, which was discovered by our industrial fellows. A manufacturer wanted a new finish for wood—an enamel that would be better than anything yet produced. He provided a fund of \$1,500 for the first year and \$4,200 a year for two years more, with a bonus of 25 per cent. of the stock of his company for the three scientists engaged in the research. The product which they have evolved is revolutionary. The only enamel now in use which approaches it in quality has to be made

and applied under very high pressures and at high temperature. This is produced and readily worked at 60 deg. C., or about 140 deg. Fahr., and without heavy pressures. It is clear and translucent, can be dyed or colored as desired, and is a perfect substitute for vulcanite in every possible use, both because of its elasticity and its hardness and high insulating power. It is odorless, insoluble in acids or alkalis, and nonexplosive. It can be used as a binding material, as with sawdust for artificial flooring, or with carborundum for grinding and polishing. I regard it as one of the most important industrial discoveries of recent years.

"Another very important research is one which is now in its third year, in petroleum. There was a variety of problems presented to the nine fellows engaged in this work. The endowment is \$10,000 a year for three years and the bonus a 10 per cent. interest in the discoveries made. One of the most important results so far attained is the discovery of a cheap and practical method of extracting high grade gasoline from petroleum wastes which have heretofore been thrown away. The importance of this, in view of the tremendous increase in the demand for gasoline, is apparent. These fellows have also discovered a new method of distilling lubricating oils, which gives better results than any process heretofore used.

"The problem of the preservation of orange juice has puzzled the Florida and California fruit growers for 30 years. No matter what preservatives were used, the preserved juice would eventually turn brown. A practical and cheap method of preserving it would make it possible to utilize a large part of the orange crop which is now wasted. One of our fellows has discovered such a process, whereby orange juice can not only be preserved, but crystallized, so that it can be packed and handled in a dry form; again becoming true orange juice when mixed with water, the only change being that it is slightly less sweet than when first pressed. No artificial preservatives of any kind are used.

"One of our most important lines of research, so far as Pittsburgh is concerned, is the effort to find an effective, yet commercially practical way of abolishing the smoke nuisance. The sum of \$41,000 was given during a period of three years, and we have now found the answer. The passage of a high-potential current of electricity, of low amperage, through very small wires suspended vertically in a flue, has been found to cause the precipitation of the carbon particles in the smoke. Arrangements are being made to give Pittsburgh the first opportunity to avail itself of this discovery, which was financed from motives of public spirit more than the desire for commercial gain.

"The utilization of leather scrap; a method of making glass of a new and distinctive color; the whole subject of the chemistry of glue, of which little is known; methods of coating steel with copper; questions dealing with the utilization of natural gas; the production of cement, and the corrosion of steam radiators—these are among the practical, present-day industrial problems which are being attacked under these industrial fellowships. Most of them will be solved. There have been but two failures so far to get the results sought, and these were such as to reflect no discredit on the institute.

"A particularly interesting problem of far-reaching importance is involved in an industrial fellowship, negotiations for the endowment for which are now under way. The positive results that have been achieved in the use of radium for the treatment of cancer have made the question of the world's radium supply a vital one. Scientists have long known that the Roentgen rays—the ordinary 'X-rays'—are identical with the curative rays of radium—the so-called 'gamma' rays—except that the X-rays have much less penetrating power. It has been suggested that if some means could be found to produce by the electric current X-rays having the penetrating power of the gamma rays, the curative powers of radium would be at the command of every physician at a trifling expense. It will require a fund of at least \$7,000 a year for an industrial fel-

lowship having this discovery as its object. It will take some time to find the best equipped man to undertake this research, for, as I have told you, it is easier to get money than men. But he will be found, and the work will be undertaken.

"If this discovery shall be made and everything else we have accomplished should be wiped out, our work will have justified the faith of its founders."

MEETING OF CARRIAGE MAKERS' CLUB

At the annual meeting, election and dinner of the Carriage Makers' Club held at the Business Men's Club, Cincinnati, Thursday evening, March 12, the following members of the Board of Governors were chosen: Harry Roettinger, Glen Perrine, B. L. Craig and C. F. Egolf.

George F. Dieterle, president of the Chamber of Commerce, was the principal speaker of the evening. His subject was "Cincinnati." Attorney Robert P. Hargitt, president of the Home Savings Bank, spoke on "Personal Observations of Institutions of Austria."

The advisability of the formation of a mutual association of carriage manufacturers and accessory lines for the handling of indemnity insurance under the new state workmen's liability and compensation law was the subject of a report of a special committee. It was pointed out that, at present, a premium of \$10,000 is paid to the state, and under the plan of the committee this would be reduced to \$2,500. The proposed organization would have to deposit a fund of \$5,000 with the state and also give bond for the payment of insurance claims. A detailed report will be sent to each member and if 75 per cent. approve, the association will be formed. Theodore Luth, B. L. Craig and P. P. Hunter composed the committee.

STRIKING CHANGES IN AMERICAN TRADE

During the last third of a century factory products have been steadily supplanting the products of the farm in the export trade of the United States. In 1880, agricultural products formed 84.3 per cent. of the exports, and manufactures (exclusive of foodstuffs) only 14.78 per cent. In 1913 the proportion of manufactures in the export trade had increased to 48.8 per cent., while that of agricultural products had dropped to 46.1 per cent. With the increase in exports of manufactures there has been a steady increase in the imports of raw materials for use in manufacturing.

These and other significant changes in our trade are analyzed in an interesting manner in the "Annual review of the foreign commerce of the United States," a bulletin just issued by the Bureau of Foreign and Domestic Commerce.

RECEIVERSHIP EXPENSES

The receivership for the Michigan Buggy Co., which was later adjudged bankrupt, cost the estate \$25,538.50 in attorney's fees and compensation for the Detroit Trust Co., which acted as receiver for the concern, according to a statement issued to the creditors by Judge Clarence W. Sessions, of the United States district court at Grand Rapids.

Of this amount the Detroit Trust Co., which secured men to make the appraisals of the assets and take charge of the plant, will receive \$15,000, the remainder being the attorneys' fees for the administration of the legal affairs of the estate.

TAKES HIS BREATH THROUGH A TUBE

Among the horses employed in the street cleaning department of Cincinnati is one upon which a surgical operation was performed to save its life. As a result this horse wears a brass tube of special design, penetrating its windpipe. All the air that the horse breathes now goes through this tube.

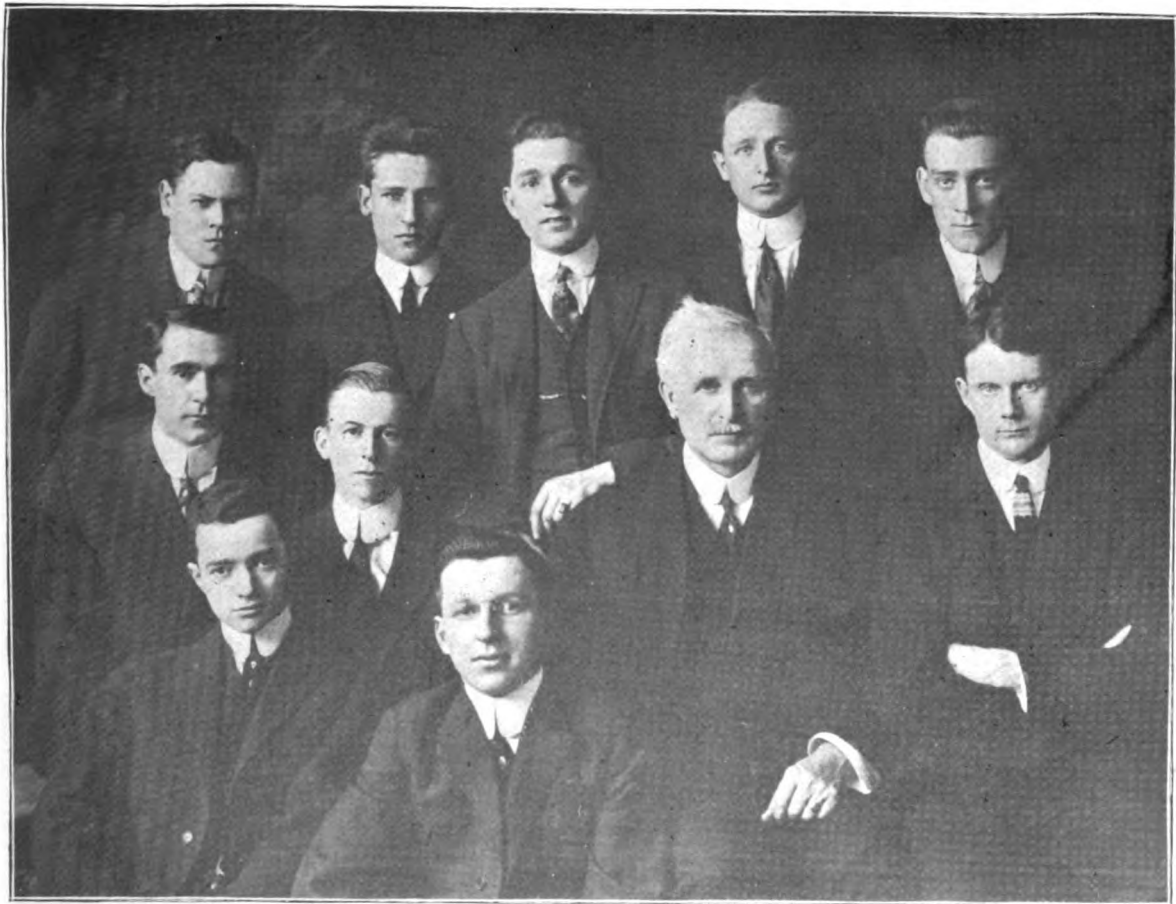
The Technical School Graduating Class, 1914

Back row from left to right—James Forsberg, Otto F. Graebner, J. Henry Robinson, John A. Greer, John M. Pullar.
 Middle row, left to right—Joseph F. Gagnon, Howard P. Taylor, A. F. Johnson, Instructor; George S. Tasman.
 Front row, left to right—James D. Trehy, Erwin L. Lare.

TECHNICAL SCHOOL CLOSSES SUCCESSFUL SEASON

Under the auspices of the General Society of Mechanics and Tradesmen of the City of New York, the Technical School for Carriage Draftsmen and Mechanics closed its term with the customary exhibition, both public and private, April 13. The closing exercises of the school department was held also, as usual, in the Engineering Societies Building. This latter is an elaborate function, with addresses, etc.

This session of this important school, established by the C.B.N.A., has been the most successful since its establishment in 1880, and marks it as the only really efficient carriage drafting school in the country, a position it has always maintained.

This season more students were enrolled than usual, and the interest in the classes was sustained.

There is always a demand for the services of the graduates by those who know, but this season three of the graduates were employed out of the school before close of term, which is an index to the demand.

At the exhibition of drawings the liveliest interest was shown by a very numerous attendance, including foremen, superintendents and employers in the vehicle trade.

The full size drawings were a striking feature, and well demonstrated the high practical quality of the instruction.

The colored drawings were a fine feature, and appreciated at their worth. The examples were about equally divided between horse-drawn and automobile.

The problems were well worked out, and they formed a

noteworthy part of the drawings. The quality of the work, the fine spirit of the students, and the morale of the school as a whole are most gratifying to all having at heart the interest of the premier carriage drafting school of the country. Prof. Johnson was warmly congratulated on the work.

AUTOMOBILE ENGINEERS STANDARDIZATION MEETING

Springs Division

The Springs Division (Harold L. Pope, chairman) is formulating a table of axle clips for use on pleasure cars, with the idea of reducing the number of sizes and submitting a design of clip that will represent the best engineering practice. Correspondence is being conducted with axle and clip manufacturers with a view to securing complete data bearing on spring clip dimensions. Data have already been collected from a large number of automobile engineers showing the practice as to the diameter of spring clip shank with relation to the width of leaf springs and giving information as to the best methods of reducing to a minimum breakage of short spring leaves.

The committee appeared to favor the use with center bolts of springs, of U. S. standard hexagon nuts tapped with S.A.E. screw standard thread. Also that nuts for spring clips have a length of one and a half times the diameter of the clip shank.

It is planned to hold another meeting of the division prior

to the meeting of the society to be held at Cape May in June, commencing on the 23d.

Nomenclature Division

The Nomenclature Division (A. B. Cummer, chairman) limited its proceedings to formal discussion as to the plan and scope of future activities. A vote was passed requesting the council to instruct the various divisions of the Standards Committee to refer to it all questions involving nomenclature. The division is co-operating with the Nomenclature Committee of the British Engineering Standards Committee, which is supported by the English government and represents the leading engineering societies and firms of Great Britain. Mr. Charles Wheeler, a member of the Council of the Institution of Automobile Engineers, who attended the last summer meeting of the S.A.E., is chairman of the British nomenclature committee. A letter from him was read at the standards committee meeting announcing that he was sending for the consideration of the S.A.E. nomenclature division, a list of words and phrases which is now under the consideration of his committee.

Ball and Roller Bearings Division

The Ball and Roller Bearings Division (Howard Marmon, chairman) has started upon the task of reducing the number of stock sizes of roller bearings in the case of the so-called short sizes which are not interchangeable with the dimensions which have already been accepted for ball bearings.

S.A.E. Standards

S.A.E. standards are almost generally used and reduce or simplify labor in the engineering, production and service departments. The money saving affected by the reduction in labor and the facilities with which materials can be secured, can be estimated and is large. The members of the society practically unanimously favor standardization along sound lines to a degree that will not hamper the individuality of the engineer. Recommended practices of the society have been of incalculable benefit to the automobile industry at large.

THE LIGHT CAR

To the agent and to the body builder the light car movement is one that cannot be ignored, and, developed on right lines, there is no reason why it should not prove a valuable asset in their business. Practically all authorities in the motor trade are agreed that the market for the big expensive car is nearly filled, and that the present is essentially the day of the moderate and inexpensively priced car. The market of the moderately priced car is, of course, no new thing to the trade; and in view of the possibilities that it offers in correspondingly light running expenses, there is no reason why it should not be used greatly to widen the field of the salesman. But exactly what lines its development will take, he would be a bold man who would prophesy.

A NEW ONE

"The Horse Lover" is the name of a brand new monthly launched by The National Association Allied Horse Interests. The publication office is 497 Pearl street, New York City. Monthly, \$1 per year.

This is to be a horse-militant periodical, with no malice, but a bit of a club for all automobile pretense. We quote the responsible man, who says:

"To speak a little more plainly, lest we be misunderstood, the Association intends to devote whatever space may be needed for publishing facts about the horse and the horse-drawn vehicle, which have received but little publicity during the past 15 years. If it sounds more forceful, we throw down the gauntlet to the motor truck advertisers, agents and salesmen who, to speak charitably, have misrepresented facts so long that they now almost believe them themselves. Sad may be, but true it is, arguments have been practically all in favor

of the motor truck, but there's always two sides to any question, and the horse is beginning to kick.

"A very prominent salesman of a large motor truck concern recently said, 'I know we have pulled the wool over the eyes of many a reluctant buyer during the past few years, and we have skimmed the cream off the milk. We must now get down to a substantial selling basis, tell the truth and sell motor trucks where results will substantiate claims.' Very true, Mr. Salesman, and we will lend you our united effort to help you down to that basis, and we will be truthful, steadfast and persistent in our assistance. Rest assured that for once, at least, a motor truck salesman has told the truth; lose no sleep over the idea that you have said more than many of us believed to be true a long time ago, and go on your way at last with a conscience that must be considerably happier than it could have been when you were destroying business instead of helping to build it up."

IS THIS TRUCK-LING TO THE HORSE?

Far more interesting than even the remarkable increase in the use of horse-drawn vehicles in 23 of the 33 cities considered, or the slight percentage of decrease in ten of the cities tabulated, is the decrease in 1912 over 1911 in the number of licensed horse-drawn vehicles in ten cities and the marked increase in 1913 over 1912 in the same communities.

Take, for example, the city of Boston, which dropped from 6,518 in 1911 to 6,457 in 1912, then rose to 6,489 in 1913; Dayton, which fell from 3,965 in 1911 to 3,563 in 1912 and then showed a gain of 187 in 1913; Indianapolis, which decreased 1,439 from 1911 to 1912, then increased 336 in 1913 over the preceding year; Omaha, which decreased 12, only to increase 380 during the next year; St. Louis, which dropped from 22,810 in 1911 to 22,250 in 1912, only to show a gain of 174 in 1913; San Francisco, which lost 555 from 1911 to 1912, yet in 1913 began at once to regain its prestige, and the busy little city of Wilkes-Barre, which licensed 30 less horse-drawn vehicles in 1912 than it did 1911, and gained in 1913 more than twice what it lost the preceding year.

Can any cubist paint a more forceful picture of trucks experimented with only to be sold at a great sacrifice or consigned to the junk heap than these figures portray?

Does anyone want a better illustration of the fact that motor trucks are expensive luxuries instead of economic factors in the business world than is shown in those commercial centers where the horse temporarily succeeded by the motor has only enjoyed a brief vacation and is now back in the harness.—The Horse Lover.

THE 24-HOUR RUN

It looks as if the 24-hour run were a big money maker, for it increases the output of a factory anywhere from 30 to 100 per cent., without increasing the capital invested in lands, buildings, machinery, taxes, insurance, and some other overhead charges. Besides, it expedites the production of goods, for articles are made twice as fast by day and night work combined as they are by day work alone. By expediting output, capital is turned quickly. By expediting output, and at the same time increasing it, capital is made to pay a much larger profit. So there will always be a tendency toward the twenty-four-hour day. Ambition for profit will always keep it alive.

THE RIGHT CYLINDER OIL

For gas engine cylinders the grade of oil usually most suitable is a mixture of 10 per cent. of neutral fixed oil with 90 per cent. of mineral oil, the viscosity of the compound being approximately the same as rape oil at a temperature of 60 degrees Fahr.

MAKING BROAD LACE

The coach lace known as broad lace is quite a stunt in the making because the patterns are varied and sometimes very intricate. A slight account of how the lace is woven has interest.

With the dress carriage luxury and splendor is gained by the use of materials of greater intrinsic value, while the keynote of the present motor body trade has been the demand for novelties.

To the non-textile worker the loom is a bewildering mass of spindles, shuttles, cords, beams, and levers, and the steady production of pieces of lace in front of the loom is a source of wonder to the uninitiated. The patient explanation as to how the warp and weft obey the mechanism of the loom is apt but to increase the confusion of the visitor until he has been able to grasp the fundamental principles by which a series of cards punched with holes is able to transform an association of threads of cotton and wool, worsted and silk, or other combination, into a piece of lace with a conventional design in a variety of colors.

The fundamental type of machine used for the production of goods which have an interwoven pattern is the Jacquard loom.

A piece of seaming or pasting lace, like a piece of cloth or cotton sheeting, consists primarily of the interlacing at right angles of warp and weft threads. The warp are the threads which run in the direction of the length of the stuff, and upon their number is decided the width of the piece of stuff, while the weft are those threads which run across the width of the stuff and in many cases do the greater part in determining the ultimate pattern.

A carriage builder in a hurry for a special lace does not appreciate the amount of work entailed in matching colors which go to make up the ground and figuring of the pattern design. Each kind of yarn has to be selected in its proper length, substance, and number of "ends," and dyed to the exact shade. Dyeing with aniline colors has nowadays been brought to a wonderful stage of perfection. Although dyeing is more or less an exact science, there are still some shades which give trouble, and sometimes delay will occur through the right shade not being forthcoming at the first venture.

The yarn having been dyed it has now to be wound on the bobbins so that in the case of the warp it may be transferred to the warp beam of the loom, while the weft has to be wound on the spools which are carried in the shuttle in its passage under and over the warp. According to the kind of material to be woven the warp bobbins may be placed in an upright frame and wound by hand on to a large cylindrical creel, several feet in diameter, from which a "cheese" of warp is made, several of which are then wound on the loom beam. In other instances, such as the making of moquettes, the bobbins are placed in frames which lie almost horizontally at the back of the loom. According to whether the moquette is a four or five frame material, so a like number of frames of bobbins have to be inserted, which represent the number of layers of warp. Each frame may hold some 250 reels on which are wound the requisite length of yarn, each frame holding a different color. The ground warp, which may be linen, cotton, or jute, and forms the foundation, is drawn directly from a beam, while the frames supply the different colored worsteds which build up the substance of the stuff, and form the loops which appear on the surface. If a velvet pile is required then these loops are cut.

From Warp Beam to Cloth Beam

At the back of the lower part of the Jacquard loom is the warp beam which runs in brackets. From this heavy roller the warp threads come, which first pass over a rail called the back rest rail, in a broad, regular, and evenly tensioned sheet, the necessary amount of strain on the warp threads being maintained by chains and weights attached to the warp beam.

From the back rest rail the warp threads pass forward to the lease rods, where they are split up and kept in their proper order before passing through the eyes or mails of the healds or heddles, each eye being fastened between an upper and lower rod or heald. Taking the simplest possible example, we may consider two eyes, each attached to their respective upper and lower healds. The mechanism of the loom is so arranged that a warp thread passing through one eye is raised, while a second warp thread passes through the other eye as it is depressed. This separation of the warp threads into an upper and lower series forms an opening called the "shed," through which the shuttle may pass with its weft and so interlace the two series of threads into a woven material. After leaving the healds the warp passes between the wire teeth or dents of the reed. This reed is held in position by a handrail above and a heavier member below called the sley, which not only helps to support the reed, but provides for the passage of the shuttles from side to side on the trashboard or shuttle race. The shuttle is in front of the reed, and it is that portion of the "shed" between the front of the reed that the shuttle works. The chief function of the reed is to "beat up" or push forward each thread of weft after it leaves the shuttle against the one which has just gone before it. The web of warp and weft thus formed then proceeds forward on to the breast or web beam, which is, of course, directly under the eye of the worker. From the breast beam the web passes down on to the feed roller which is in close contact with the cloth roller, where the material awaiting the finishing processes—carried on away from the loom—which follow, is wound.

The Loom Harness

Having thus very briefly considered the path of the warp from the warp beam to the cloth roller, it will be of interest to give an outline of the mechanism which controls the movement of the heald cords which form the shed for the path of the shuttle.

The heald cord is moved up and down by one end being attached to a lever which is actuated by a cam shaft generally somewhere near in front of the warp beam.

Tension is maintained by small weights or lingoos. Each set of heald cords which have to be raised or lowered in unison are joined to a neck cord above. These short cords then pass up through the holes of what is called a bottom board, which forms the resting place (when in their lowest position) of a series of long double-ended hooks. The lower hook is for the attachment of a neck cord, while the upper one passes round a bar, a series of which are formed in a frame called a "griffe" right at the top of the loom. Just below the "griffe" are a number of horizontal "needles" or thin rods, the back end of which has an eye to which is attached a small coil spring, the whole collection of which is contained in a box. A coil is formed in the body of the needle so that the body of one of the double-ended hooks just mentioned may pass through it. The front end of each needle passes through a board to the depth of a quarter of an inch. Here they come into contact with the cylinder which carries the set of cards on which the pattern of the material is decided by the position of the holes punched in each card.

A Card for Every "Pick"

The number of cards required to weave any pattern equals the number of weft threads in a pattern. If the number of "picks" or weft threads is 120 before the pattern begins to repeat again, then there will be as many cards all laced together in an endless chain and revolving round the card cylinder, which is situated in front of the needles at the top of the loom. As the loom works, the top frame in the loom or griffe moves up and down, so lifting all the hooks which are resting on the bars. The object, however, of the perforated cards is to allow some hooks to rise and others to remain stationary. If there is a hole opposite the projecting end of a needle it can pass through, and the movement of the griffe allows the

hook, with its neck and heald cord, to be raised, and consequently the corresponding warp thread. If there is no hole in the card opposite the end of the needle, then the needle is pushed back against its spring, a side movement sufficient to push the top end of the hook out of the way of the bar on the griffe, so that the warp threads below connected to this hook are unaffected. After the passing of the card the coil spring brings the needle back again to await either a hole or the unpierced surface of the next card.

Looping Wires

The Jacquard loom makes, say, a 54 in. moquette, a 2½ in. broad lace, or a piece of pasting or seaming, for there is much similarity in the manufacture. One loom will be given up entirely to the production of a length of moquette, whereas with the lace several pieces of the same pattern will be made at once on the same loom, or various pieces of similar patterns. In weaving a carpet-like structure such as these goods possess, steel wires are inserted mechanically between the linen and worsted warps, which form the loops appearing on the surface. The lengths of the wires are necessarily in keeping with the width of the web being made, and their working corresponds to the movement of the shuttle. As the sley goes forward a wire is carried forward also by special mechanism to loop up the coming warp, and as the sley goes back a wire, which has already performed its function, is expelled sideways out of the loom.

Where the pile is cut, as with a terry velvet, the looping wire is oval shape so as to form a higher loop, while at one end it is hammered out and sharpened to a knife edge, which cuts the pile as it is drawn out. After a moquette leaves the loom it is cleaned between the rollers of a brushing machine, and is also shaved by being passed between a heavy roller and a worm-shaped cutting wheel, the edges of which are provided with very fine saw-like teeth.

SHOP AND OFFICE SEEM TO DISAGREE

There appears to be more or less of a conflict going on between shop and office departments in a business, and the reasons have been sought and defined by a writer in *American Machinist*, who says that most all of us can recall instances of a trained business man undertaking to carry on manufacturing business, resulting in partial or complete failure, because he could not be made to see the importance of having the proper equipment in the shops, of having the best men in responsible positions, and allowing things to be so organized and managed by them as to secure the highest efficiency. This is a common failing of business men who undertake to carry on a manufacturing business. Mechanics can see this fault very plainly, and are often heard to express surprise and disgust at its manifestation.

But mechanics who go into business for themselves are very liable to make a similar mistake, only in a different direction, so to speak. They know full well that a shop must have the latest improved tools, must be kept neat and clean, and that a perfect system must be instituted and rigorously maintained. But they forget that the very same principles apply to the office and to the methods of carrying on the business end of the enterprise. The mechanic is disgusted with the business man who, while he considers it of prime importance to have a neat, orderly, and systematically conducted office, divided into different compartments for the proper and necessary separation of the various divisions of the business, and equipped with the latest improved desks, cabinet letter files, and type-writing machines, etc., thinks that the cheapest tool or machine is the proper one to buy, regardless of any other consideration, and cannot see the necessity for a decent drafting room, nor for a tool room, nor why the boiler making and the lathe work cannot just as well be done in the same room.

But the mechanic who goes into business for himself, and

sees to it that he has the proper tools and shop arrangements generally, while he allows the office—which, after all, is nothing more or less than a business workshop—to be shabby, dirty, and disorderly, without good furniture and convenient appliances for the orderly and systematic conduct of business, makes a mistake of precisely the same nature, and one which is often attended with precisely the same results. Time spent in hunting for a letter containing quotations of prices, an order for work, or other important matter, or for a pamphlet or catalogue of importance, is just as much lost as is time spent in looking for taps, reamers, or lathe dogs in the shop. A thorough system of accounts, in charge of a competent book-keeper, is as important as a good tool room system; and good desks and cabinet letter files in which paper can be kept clean and in order, and instantly found when wanted, are as important as good lathes, planers, and drill presses, in proportion to the money required to secure them, if not more so.

System, order, and the adoption of correct methods are as important in one part of a business as in another, and those who recognize this fact are the successful manufacturers, whether trained as mechanics or business men. Those who fail to recognize it, and yet manage to get along, either do not meet with the competition of others upon even ground, or are not successful.

VEHICLE DEALER'S IDEAS ON EXPANSION

The possibilities of expanding business in the implement and vehicle line by personal solicitation are great. A man handling a general merchandise line, as it is known, does not, as a rule, solicit business only through advertising, while in the implement and vehicle line it is necessary to use all kinds of inducements to get customers interested sufficiently to make purchases. We all know that many progressive retail dealers make their best profit in introducing and selling specialties. One cannot cover very much territory and work trade in that manner.

The most successful dealers are the ones who are handling a varied line and have something to sell throughout the entire year. A full knowledge of costs proves this statement beyond a doubt.

SPORTING TYPE MODELS

There is a strong demand, particularly in France, for what are commonly known as sporting type models. These are lightened chassis with a very efficient engine, generally of small dimensions. To satisfy this demand, the standard type of motor with valves on one side has often been discarded in favor of a motor with valves on opposite sides, or mounted vertically or inclined in the head. In other cases, manufacturers have been content to get more power for the sporting model by increasing the compression, lightening the reciprocating parts, changing the timing and fitting a special carbureter. Few firms have thought fit to neglect the sporting type car.

"CYCLE CAR" IS OFFICIALLY DEFINED

Speculation which has been rife regarding just what is a "cycle car" and just what is not a "cycle car," that hybrid form of vehicle which is neither an automobile nor a motorcycle, at length has been set at rest by a joint ruling defining the term which has been issued by the British Auto-Cycle Union to the Royal Automobile Club of Great Britain. In it, it is pointed out that the chassis weight of a cycle car "must not exceed 600 lbs., inclusive of the weight of the tires, or, in the case of those vehicles, the bodies of which are separate from the chassis, the total weight, all on and ready for the road, but without fuel, oil or water, must not exceed a total of 700 lbs."

COST OF HORSE AND AUTO CONTRASTED

Detroit will make 395,000 machines during the present fiscal year, which closes October 1, 1914. Perhaps all other manufacturers, taking the entire country over, will make enough to bring the number to a million, which is an extraordinary estimate.

The grand total of money represented in the purchase of a million machines, if bought yearly for the next ten years and the price averaged \$1,000 each, is eleven billion three hundred and forty-three million and forty thousand dollars.

Suppose now that we make a comparison and take the same number of horses and figure up their cost, original and up-keep, during the same period of time. Beginning, as in the case of the single purchaser of an automobile, we will take only one horse and compute the total by multiplication. Turning to the horse and taking the same number of head into consideration, based on one individual purchaser's expense for ten years and including all cost, viz.: original price, which is estimated at \$250, up-keep for one year, \$260 or \$5 per week to pay for feed, stabling, shoeing, harness and wagon repairs, doctors' bills and incidentals, the total cost for ten years on one owner of a single horse, interest on the investment being counted in, as follows:

\$250.00	cost of horse.
260.00	up-keep 1st year at \$5 per week.
<hr/>	
\$510.00	
30.60	interest (6%) 1 year.
<hr/>	
\$540.60	cost end 1st year.
260.00	up-keep 2d year.
<hr/>	
\$800.60	
48.04	interest 2d year.
<hr/>	
\$848.64	cost end of 2d year.
260.00	up-keep 3d year.
<hr/>	
\$1,108.64	
66.52	interest 3d year.
<hr/>	
\$1,175.16	cost end of 3d year.
260.00	up-keep 4th year.
<hr/>	
\$1,435.16	
86.10	interest 4th year.
<hr/>	
\$1,521.26	
260.00	up-keep 5th year.
<hr/>	
\$1,781.26	
106.87	interest 5th year.
<hr/>	
\$1,888.13	cost end 5th year.
260.00	up-keep 6th year.
<hr/>	
\$2,148.13	
128.88	interest 6th year.
<hr/>	
\$2,277.01	cost end 6th year.
260.00	up-keep 7th year.
<hr/>	
\$2,537.01	
152.22	interest 7th year.
<hr/>	
\$2,689.23	cost end 7th year.
260.00	up-keep 8th year.
<hr/>	
\$2,949.23	
176.95	interest 8th year.
<hr/>	
\$3,126.18	cost end 8th year.
260.00	up-keep 9th year.
<hr/>	
3,386.18	
203.17	interest 9th year.
<hr/>	
\$3,589.35	cost end 9th year.
260.00	up-keep 10th year.
<hr/>	
\$3,849.35	

230.96 interest 10th year.

\$4,080.31 cost end of 10th year.

If we multiply in order to get the same basis as they reached in the case of one million automobiles which is likely to be sold by American manufacturers this year, we get the grand total of expense for one million horses as being four billion eight million and thirty-one thousand dollars, or a difference of about six and one-half billion of dollars between the cost of the investment involved by the owners of machines and horses.

While we pencil this reference, the enormous amount of money involved in the making and keeping up of these horseless conveyances suggests itself to our thoughts and without claiming actual correctness of the figures presented, they are sufficiently so to enable one to arrive at a conclusion as to the sum of money that the American people pay for the luxury and accommodation which automobiles and motor trucks afford. Here are the figures:

\$1,000.00	cost of auto.
600.00	up-keep 1st year.
<hr/>	
\$1,600.00	
96.00	interest (6%) 1st year.
<hr/>	
\$1,696.00	cost of auto for the 1st year.
600.00	up-keep 2d year.
<hr/>	
\$2,296.00	
137.76	interest 2d year.
<hr/>	
\$2,433.76	cost at end of 2d year.
600.00	up-keep 3d year.
<hr/>	
\$3,033.76	
181.92	interest 3d year.
<hr/>	
\$3,215.68	cost of auto for 3 years.
3	
<hr/>	
\$9,647.04	cost of 3 autos in 9 years.
1,696.00	new auto the 10th year, interest included.
<hr/>	
\$11,343.00	cost of four machines for 10 years.

It will be noticed that the added cost of a new wagon or buggy is not included in mention, the reason being that with ordinary care either will last for ten years, but should this not be, then an allowance of about \$150 added to the total provides fully for such cost. Besides this item, the wages of horse driver and machine chauffeur, not being included in the summary would, if charged against the up-keep, add considerably to the total investment of automobile over what could be set against the horse conveyance, for it is true that the chauffeur receives better wages than does the driver of the horse.

The point aimed to be reached is as to the relative investment which the machine owner and horse owner is compelled to make, if the use of either is continued for ten continuous years, according to Horseshoers' Journal. It is admitted that the automobile will get over considerably more ground during a day than the horse can cover, but on the other hand the latter is on the job every work day during the year, something that cannot be said for the machine. It is along just such lines that a business man figures when the matter of conveyance and general utility is being considered, and shout as they may, neither the auto or horse champion can present arguments in favor of their preference which will stand against hard fact brought down in cold figures. Again we repeat, "The fittest will survive, and to the man "up a tree" things continue to look good for the horse.

BRANCHING OUT

Firestone Tire & Rubber Co. have added generator tubing, pump tubing, and horn bulbs to their list of accessory products, also tape in 1, 2 and 4 oz. rolls.

STANDARD CHASSIS MEASUREMENTS

Proposals as to the above important matter have been the subject of consideration by the Institute of British Carriage Manufacturers. A table of suggested measurements has been sent to chassis makers. Here are some of the points:

Steering—This is described as (a) special excessive raked, (b) ordinary raked steering, and (c) standard steering. The excessive raked steering is for the two-seater body, the raked steering for four-seaters and small closed cars, while the normal steering is for large landaulettes and limousines with emergency seats facing forward, and larger bodies, as well as the four-seaters and closed cars designed more compactly. The three grades of steering are respectively 32 x 18, 28 x 24, and 24 x 27 in. Many chassis average these dimensions, and it should not be much trouble for many manufacturers to conform to these sizes without altering the general characteristics of their models.

Dash to Tangent of Hind Wheel—This dimension is set forth as 67 in. for two-seaters, 71 in. for phaetons and small closed cars, 79 in. for large closed cars, and 84 in. for the largest types of cars. With the four-seater and small limousine and landaulette types the 71 in. from dash to hind wheel tangent remains unaltered, with either the 28 or 24 in. measurement from dash to back of steering wheel, so that a landaulette with raked steering has an allowance of 43 in. from the steering wheel to the hind wheel tangent. This, however, leaves room for an 18 in. driving seat, 2 in. pillar, and 24 in. door, although, as no distance from the ground to the top of the chassis is mentioned, or wheel diameter, it is impossible to plot out the doorway exactly.

Rise of Frame—This item, which has always been a nuisance to body builders who desire to mount their work accurately, is put down at 3½ in. for all chassis, whatever the type of steering or type of body adopted. The rise is located by a measurement from the dashboard and one taken between the verticals which mark the beginning and end of the rise. Although not so shown on the diagram, the distance from the dash to the tangent of the hind wheel and from the dash to the beginning of the rise of the frame shall, it is proposed, be the same, according to the figures in the table, which would certainly be a simplification. The length of the rise of the frame it is not proposed to standardize at present, neither are any radii given from the return curve of the profile of the rise. If the rise in the frame is to be 3½ in. with all chassis, then it is but a step farther to make the actual profile of the rise the same in all chassis, which would mean, if carried through, that a familiar pattern in the carriage builder's saw-mills and body shops would be this profile pattern, which the workman would use when marking out his runners or bottom sides.

Width of the Frame—This measurement is set down as 35½ in. for all chassis, and a step in the right direction, since it will mean that the majority of the smaller and medium-sized chassis will have to be widened.

Nothing is mentioned with regard to the position of the gear and brake levers, although the suggestion is put forth that the standardization of the pedal position would be appreciated by the Institute. The Institute also does not say anything about hind springs. If nothing comes above the top of the side member of the chassis all will be well, but probably every ordinary member of the Institute has been put to considerable expense and annoyance by the presence of three-quarter hind springs the actual position of which was not properly defined on the blue print. On the whole we think that the measurements given are useful and meet present requirements, and as an initial scheme it is excellent, but, from a practical point of view the proposals are incomplete, in that the question of the levers is ignored, which is of great importance, seeing the proportion of bodies which have doors to the driving seat and

whose side sweep is largely dependent on the position of these levers.

If the stream-line front of bodies is to be fashionable for the next few years, it would mean that the scuttle dash would, of course, have to be made at a later stage so as to conform to the contours of the bonnet.

Probably further proposals will deal with the question of wheel track. Very few cars except two-seaters can be designed without regard to the hind wheel track, and if 35½ in. is decided for the chassis, then probably 4 ft. 8 in. would be a corresponding measurement for the distance from center to center of the hind tires.

HANDBOOK ON RUSSIA

The Russian empire, covering one-seventh of the land area of the globe and only sparsely settled in spite of its nearly 170,000,000 inhabitants, offers an interesting subject for study for both business men and economists. This country today presents a picture of economic development comparable with that of the United States of three or four generations ago, in that Russia is now chiefly a producer of raw materials derived from nature.

The total value of the foreign trade of European Russia, in 1912, according to official figures, was more than \$1,200,000,000, in which the United States participated to the extent of only \$53,000,000. However, the indirect trade between the two countries passing through foreign middlemen brings the value of the sales of American products to Russia to \$80,000,000, and the exports from Russia to the United States to \$30,000,000. Largely owing to the lack of knowledge among American business men of the possibilities of the Russian market, the trade between the two countries is on the threshold only of its possible development. The monograph on Russia just published by the Bureau of Foreign and Domestic Commerce, Washington, D. C., entitled "Handbook on Russia," should be of special interest.

This book contains nearly 20 pages, with two maps, and includes a comprehensive description of the economic situation in European Russia, by Consul General John H. Snodgrass, stationed at Moscow; reviews of the commerce of various districts in 1912, by the American consuls stationed in Russia; and a very timely description of commercial and industrial conditions in Siberia, by Consul John F. Jewell, stationed at Vladivostok. To those who still regard that country as a frozen waste the picture presented by Mr. Jewell will be a revelation. He compares Siberia today with Canada of a generation ago, and points out the possibilities of great trade development that lie in the great natural resources of the country.

AUTOS IN JAMAICA

American automobiles are much used in Jamaica, where they are growing in popularity. In the Port Antonio consular district of two parishes (there are 14 parishes in the island) more than 50 motor cars are in use, nearly all being of American manufacture. During the tourist season motor cars are in great demand in Port Antonio by travelers who spend some time here or who stop off to motor across the island to Kingston, where they catch their boat for the more southern ports of their itinerary.

PARRY TRAVELERS

The Parry Mfg. Co., of Indianapolis, Ind., has appointed C. P. Thomas representative in Florida and Georgia. Mr. Thomas knows buggies, having had a long experience in the retail business. L. Stanley, of Cincinnati, who has been traveling for the company in Kansas, has been transferred to territory in northern Ohio and western Pennsylvania. Here he succeeds H. O. McDaniel, who has been transferred to southern Ohio.

Paint Shop

LAWSON VALENTINE PULSIFER TALKS VARNISH

Mr. Pulsifer is the chief chemist of Valentine & Company, as well as the son of the president of Valentine & Company, and is credited with being the discoverer of the valspar (combination of Valentine and spar) varnish about which he writes. He is said to be one of the cleverest investigators in the country in the chemistry of varnish making. What he has set down for Power Boating, where we found the article, is something like the sample of a piece of dry goods. It is just an idea of what the real thing may be like. If Mr. Pulsifer could be induced to really tell something, listening would be worth while! And a good many varnish makers and writers on the subject of what they (don't) know about varnish, would be found in the audience. But here follows what Mr. Pulsifer did write:

An encyclopedia could easily be written without transgressing the limits, presented by the above title, for the varieties of varnish are almost countless, and in their uses they touch practically every field of human endeavor. They range in color from jet black to water white—in drying from a few minutes to a fortnight—in durability from a few weeks to years. The label on your can of tomato soup is varnished, the railway car you ride in is varnished—your hair brush, your patent leather shoes, your bicycle, your floors, your furniture, your everything practically is varnished, not to mention your fish stories, and your tale of how many knots that new hydroplane makes! Varnish ranges in price from 25 cents a gallon for "Sealing" varnish, to \$6 a gallon for the best automobile varnish. All varnishes may be divided into two general groups, (1) Spirit varnishes—shellac, damar, etc.; (2) Oil varnishes, to which group Spar varnish belongs and in which, as you are reading this article, you are probably the most interested. Spar varnish is not only an oil varnish, but it is (or should be) a "long oil" varnish, and to explain this term, we will go briefly into the manufacture of oil varnishes. These are combinations of a copal gum (in a high grade varnish one of the so-called fossil gums, such as Kauri); a vegetable oil, such as linseed, or China wood oil and a volatile oil, such as turpentine, for high grade varnishes, and a mineral thinner—benzine, etc., for cheap varnishes. They also contain certain metallic compounds, usually of lead or manganese, which impart to oil varnishes their drying properties, for this "drying" is an oxidation of the film, which thereby changes from a liquid to a solid.

How Varnish Is Made

In making varnish, the gum, which has previously been graded and carefully sorted, is put in a large copper kettle and melted over an extremely hot fire. When the melting operation is completed, the oil, which has been aged, refined, and often heat-treated, is added and the gum and oil carefully cooked together until thoroughly combined. Then the kettle is taken off the fire—wheeled into another building or room, and when the "batch" is cooled sufficiently, the turpentine or other thinner is slowly added, until the right consistency to insure proper brushing qualities is reached. The driers, i. e., oxides, etc., of lead and manganese may be added either to the oil before it is combined with the gum, or to the heated combination of gum and oil.

Now, whether the varnish made is to be a "short oil" or a "long oil" varnish depends on the proportion of oil to gum, which it contains. Thus a "short oil" varnish may contain

from 5 to 10 gallons of oil to 100 pounds of gum; to this class belong piano varnishes, carriage rubbing varnishes, interior varnishes, etc. A "long oil" varnish may contain 25 to 35 gallons of oil to 100 pounds of gum and to this class belong automobile body varnishes, railway coach finishing varnish, spar varnishes, etc. In an oil varnish the gum imparts hardness and brilliancy and the oil imparts toughness and elasticity. Thus in general a short oil varnish is quick drying, hard and brilliant, but lacks durability, while a long oil varnish is elastic and durable, but slow in drying and hardening. Owing, however to recent advances in the art of varnish making, it is possible to obtain the hitherto antagonistic qualities of quick and hard drying, and extreme elasticity and durability in the same varnish. This, of course, forms the ideal combination for a spar varnish, for the conditions under which much boat varnishing is done, are often unfavorable to the drying of ordinary long oil varnishes, and yet the exposure to which a boat is subjected is far too severe to permit of the use of a quick drying short oil varnish, with its relatively poor resisting qualities.

Varnish Has Two Duties to Perform

The varnish on your boat has two duties to perform—first and most important, the protection of the wood on which it is put, and as a boat is probably wet at least half of the time—from rain and fog, spray and dew, and from the water itself—it is readily seen that to properly protect, the varnish used must first of all be waterproof. And it must have sufficient elasticity to resist for the whole season, if possible, the action of the sun and of frequent changes of temperature. The second duty of a spar varnish is that of showing in its true beauty the wood of your "bright work" and your spars, and to do this it must be hard enough to resist scratching and marring as much as possible, and it must not turn white or grow dull from the long continued action of water. The varnish you choose should be capable, if properly applied, of carrying you through the season without re-varnishing, other than the inevitable touching up, necessary by little accidents of one kind or another—and it should possess a drying and hardening of such rapidity that "touching up" does not mean "laying up."

A detailed account of how to use spar varnish would fill many more pages than can be allotted to this article, and as with the subject of varnish itself a general description is all that it is possible to give here.

In the first place, buy good varnishes from a manufacturer of established reputation, as nowhere is false economy more foolish than in the purchase of cheap varnishes or paints, for in most cases the cost of the labor is many times the cost of the material, and one re-varnishing will more than wipe out any possible saving from buying poor stock. Use a clean varnish brush free from grit, oil, grease, or moisture, and when you are through varnishing clean out the brush, preferably with turpentine, as otherwise the varnish may harden in the brush and the result will be a specky job the next time the brush is used.

Wood Should Be Properly Prepared

On new work be sure the wood is thoroughly seasoned and is dry and clean. Remember that you are "building" a finish and that as in all building the foundation is of the utmost importance. Don't use shellac for a filler or first coater, as it is far too brittle to give proper support to a tough and elastic spar varnish. On close-grained woods, such as cherry, birch, maple, etc., no filler is necessary and the varnish may be used

right on the wood (after the latter has been stained, if desired), thinning the first coat with about 20 per cent. of pure turpentine. The following coats, and at least two more are necessary for first class work, should be applied just as the varnish comes from the can. Thinning varnish other than for the purpose mentioned above is the poorest kind of practice, as it cuts down the body and consequently the durability of the coat in just the proportions in which the thinner is added. Also don't try to "gild the lily" by adding dryer or oil or anything else to the varnish you buy.

On open-grained woods, such as oak, ash, mahogany, etc., fill the grain with a high grade paste filler—those having siliceous, i. e., pulverized silica—for a base being the best. If the wood has been stained, tint the filler japan color until the desired shade is obtained. Sandpaper the filler smooth after it is dry and proceed with your spar varnish. Now a word as to varnishing: Don't try to spread a pint of varnish over all the spars, deckhouse and the dinghy! Even when properly applied it takes in the neighborhood of one thousand coats of varnish to make the thickness of an inch, so don't skimp your coats, and don't expect one coat to wear a season. Fill your brush well with the varnish and flow on a full round coat—to gauge to a nicety the difference between a coat that is "full" and one that is "full and overflowing" will require some practice, for too much is as bad as too little. A coat that is too heavy will run down in "curtains" that are not exactly a delight to the eye. Also a coat that is too heavy cannot harden through properly and checking is liable to result.

Be Sure Each Coat Is Dry

Be sure that each coat of stain, filler or varnish is thoroughly dry before applying the next coat. Varnishing on imperfectly dried or greasy undercoats is inviting sure destruction. The time for proper drying will be stated on the label of the material you use and it is well to note that as a general proposition no harm can come from reading the directions on the can carefully—before you begin.

Under coats of varnish may be sandpapered, very lightly, with O. O. sandpaper, if desired, but rubbing down with pumice stone flour, water and a piece of felt is better, as this is not liable to cut through the film of varnish or scratch the surface.

On old work the procedure depends on the condition of the surface when "fitting-out" time comes; if it is in A1 shape, sandpaper down and apply two or three coats of varnish. If in poor condition, scrape it off with glass or a steel scraper, if possible, as this is a safer method than the use of a varnish remover. If, however, you do use a remover, be sure to remove it in its turn thoroughly and carefully by washing with gasoline, benzine, or, better still, benzole. Otherwise, any particle of the remover remaining on the surface or in the pores of the wood, will start quietly and unobtrusively removing your new varnish from the inside and a mysterious case of peeling and perishing will develop.

Bleaching with Oxalic Acid

If the wood is oak, and it is impossible to avoid bleaching it with oxalic acid, be sure to neutralize the acid afterward with an alkali—a weak solution of ammonia or washing soda in hot water is best for this purpose. Then wash down thoroughly with plenty of clear, warm water. There appears to be a superstition in the boat painting business that vinegar is a fine thing with which to "neutralize" oxalic acid. As vinegar is an acid itself, this process is just about as effective as trying to bail out a leaky boat by boring a hole in the bottom! Any oxalic acid left in the wood is sure to destroy the finish.

In conclusion, it is well to remember that when things go wrong, the fault is not always with the varnish, for there are many local conditions that can cause trouble. If you have purchased a high grade spar varnish from a reputable manufacturer, you have received in your can the best article that the manufacturer has been able to produce—backed by his experi-

ence, his invested capital and his honesty of purpose—and you will always find him willing to furnish information for your guidance and to assist in locating the cause of the trouble, if trouble comes.

Nothing is more handsome than a perfectly finished yacht, and perfection in anything requires care and skill and patience, but no one seriously doubts that it is worth while.

PAINTING METAL CAR BODIES

Although the painting of automobile bodies is not an exceptionally difficult job, there is a great deal of difference between the operations of painting metal bodies and wooden ones. Perhaps the two most important differences are that the priming coat that is used on wood is not at all suitable for use on metal, because with metal there is no absorption, and that the smaller the amount of paint put over metal surfaces, consistent with the proper color and finish, the better and the more lasting will be the work.

Obviously, metal requires to be prepared to receive the paint quite as carefully as does wood, and for the operation experts are practically agreed that the sand blast is best, for it not only clears away all mill scale and rust or other corrosion but leaves the surface in a minutely roughened condition which is ideal for the reception of the paint. There are other methods of preparing the surface, of which pickling with sulphuric acid is best known. The operation, however, takes considerable time and there is the ever present danger of damage to property through careless handling of the acid. In the absence of a sand blast, the best method is to rub the surfaces down with emery.

After the surface has been prepared, it is time for the priming coat, and here the first difference between the operations on wooden and metal bodies becomes apparent, for an ordinary oil primer will not do at all. Sometimes less penetrating yet possessing all, or a very large part, of the adhesive qualities of the old oil and lead primer is necessary. Moreover, it has been learned through tests and experiments that oil does not adhere to steel with the tenacity of some other mediums—varnish, for instance. But varnish alone and apart from any other medium is questioned as being entirely well adapted for the steel surface.

A combination of raw linseed oil, elastic finishing varnish, japan gold size, and turpentine, with a stain of mineral brown, or even of the latest brand of red lead, will give, when rightly made up, a primer that will stick to the metal and furnish a friendly foundation for the following coats.

PICKING-OUT AND STRIPING

The picking-out or striping of a carriage is the most artistic part of the painter's work. The more elaborate treatment of panels is a thing of the distant past, and with the gradual change in taste and fashion the tendency is to adapt a still more plain and unrelieved style. Even striping and fine lining tends to disappear.

Picking-out is an art that can only be acquired by constant practice. The painter should practice diligently whenever opportunity permits, and so accustom his eye and hand to work together in an automatic way, for only thus can his work be good. At first he will find that his hand is unsteady, so that the line he tries to make will go every way but that in which he wants it to go. But he should not allow these facts to discourage him, for everyone must go through the same experience in learning.

The choice of colors, arrangement of lines and general scheme of decoration is not often left to the painter's discretion.

Mouldings, when used, are usually painted in relief to harmonize with the color adopted for the body, and a fine line of some contrasting color may be run on either side of the moulding to heighten the effect. For instance, a body painted dark

blue, or green, will generally have black mouldings edged with fine lines of white or red; another painted in French grey may have its mouldings in a darker shade of the same color edged with white, red, orange or some other suitable color.

But the modern tendency seems to be in the direction of eliminating mouldings, in which case the body color is left plain and unrelieved, only the wheels and springs being decorated with stripes and fine lines, and that sparingly. Sometimes a color scheme is adopted consisting of vertical stripes of two alternating shades of a similar color, such as green, red, or blue, the width of the stripes varying to suit the size of the body, but this style of decoration has never become widely popular and is now seldom seen.

CUTTING STENCIL DESIGNS

By E. E. Haver.

If one color only is desired, the whole of the design is cut out upon the one stencil, excepting what are known as ties, which must be left here and there to hold the design together, and to stiffen it up. Those ties, instead of detracting from the beauty of the finish, are really helpful in producing effects not otherwise obtainable, and in the hands of the skillful designer, instead of proving a hindrance, they will enhance the beauty of the design. Even the human face and form can be produced in one-color stencils with fine effects by the judicious selection of the proper place for putting in the ties.

It is frequently necessary to leave ties in a stencil where color must be used, in order to hold it together. In such a case, ties must be filled in by hand. Some care will have to be exercised in putting in the color with a brush that it does not differ too much from the paint put in with the pouncing of the stencil brush. The stencil brush should be used as much as possible in pouncing, that the coloring may look all alike. One-color stencils may be made more effective by using different colors, or tones of one color, in different parts of it. This requires but little more additional time in its execution. The different colors must be put in with different brushes.

In preparing stencils where more than one is used in the same color, all that will be required of the second one will be to draw and cut out the parts which form the ties in the first one. This gives the effect of solid hand-painted work, and lines can be worked out in the stencil so as to resemble hand-painted lines in the same manner. If two or more colors are to be used in the stencil work, a separate stencil must be made for each color desired and used. Great care must be taken that each stencil registers perfectly over each other, and an allowance must be made of about 1/32d of an inch, so as to insure the covering over and good joining of the two or more colors. The ties in such a case are of no importance, as the next stencil will cover them over.

Beautiful work is done in multi-color stencils, which will sometimes puzzle the inexperienced. An inexperienced stencil cutter can obtain some very close imitations of hand work in that way, and the sign painters obtain really better looking work by the use of several stencils than is usually done by hand in all but the highest priced work. The designs for the

several stencils, or for the single ones, having been drawn out in full upon the face of the stencil paper, the sheet should be placed upon the plate glass or lignumvitae block, or whatever the cutter has decided to cut upon, then with the knives he has for the purpose the cutter will proceed to cut out all the design with the exception of the ties already mentioned. The knife should be in good condition, as it will leave the edges ragged if not kept sharp. The small round holes are quicker done with a punch. The ordinary harness maker's leather punches are the best for the purpose. The stencil brushes should be of varied dips, from ¼ in. up to 1 in. When the stenciling is done in many colors, and requires several stencils to be cut, they must register perfectly over each other, or the work will be imperfect. This should be attended to in the drawing out of the design; but registering guide marks should be cut in, to enable the operator when shifting it to a new position to so place it that it will be just right; otherwise, no matter how well the design has been drawn, or how perfect each stencil may register with the others, a botchy effect will be produced by the unevenness of the lines.

The stencils, having been cut out, should now receive a coat of shellac varnish. Orange shellac is the best, and is much stronger than the white. Apply it on both sides carefully, and hang up to dry for ten or twelve hours, and then second coat and allow them to elapse well and dry before using; they will then undergo more hard usage than imagined.

PAINTING WIRE WHEELS

Now we will revamp some of the dope we used to read about in the days of the wire buggy wheel, that the stable washer put out of commission so quickly because it was such a nuisance to clean. We now consider the larger wire wheel that is making headway, for a time at least. Its painting and varnishing is the object of thought on the part of the Australasian Coachbuilder.

It will be taken that the wheels are thoroughly clean and smooth, ready for the first coat of lead. Mix this latter in equal parts gold size and varnish into a thick paste. Run through the mill or strain through fine muslin, and thin down to a very thin consistency with turpentine.

The next item is the dipping utensil. This is easily made by cutting out one side of a one-half gallon can. Have this securely fixed, so that with the wheel spinning on the horse the rim will run inside the can. On some cars the wheel will have to be finished on its own axle. Now proceed to coat up the wheel as follows: First coat up the hub. Apply the paint thin, taking particular care to do about an inch of the spokes at the same time; this does away with the necessity of touching the hub later on.

Now place the dipping pan in position, so that the rim runs true. Pour in sufficient color to cover the rim. A fair guide would be to have sufficient paint in the vessel to cover about an inch of the spokes; and, during this operation, see to it that the supply is kept up. The rim is now in position and the lower portion covered with the paint. Now take a small camel-hair brush and proceed to coat the spokes. When three spokes are painted, turn the wheel round and do the next three spokes. It will be noticed that a small portion of the rim has been coated, and while coating up the second lot of spokes, the paint on that portion of the rim coated will flow out smooth; that is, providing the paint is of the right consistency. This can only be found out by personal experience.

Carry out this operation of coating up the spokes piece by piece, and the rim will look after itself. Do not let the rim go back into the paint after once leaving the vessel.

At the final it may be found that the paint has set where the operation was started. This may be levelled down by running the brush over the lap. At this stage it is advisable to take a bristle brush and wipe up the outer groove of the rim, this being the place where the paint is more likely to accumu-



An elaborate but pleasing wagon body stencil

late. Keep the wheel swinging for a few minutes, when it may be set aside to dry.

In applying quick color have the color very thin. Coat the hub and spokes first, then run the rim through the liquid last. Clean up the outside of the rim, and keep the wheel on the spin until set.

For varnish color, mix the ingredients in equal parts gold size and varnish (this must be a varnish that will not bead), add a very small portion of turpentine, and apply as follows: First coat up the hub; next dip the rim and lift up the wheel or remove the dipping pan. This will leave the spokes to be coated up, and this will take about ten minutes. During this time the wheel should be kept in motion, which prevents the varnish color from running, and by the time the spokes are finished the rim will be set, providing this formula is followed.

The final coat of varnish should consist of a hard-drying varnish, same as used for varnish color, and the wheel should be handled in the same manner; but it is advisable to keep the wheel spinning for a considerable time. This will not entail any extra time, as the wheel may be kept on the move while coating the next.

To coat up a rim will take on an average ten minutes; but by dipping, which is done while coating the spokes, it costs nothing for labor, with the advantage that the paint or varnish is applied more evenly and the finish is cleaner. Some may be dubious as to an air-drying paint running or flowing level. It is only a matter of using the proper ingredients. They can be done in a shorter time, and, if anything, this process will give a cleaner finish.

To get the various colors the desired consistency, mix the colors as directed. Have a small can three or four inches deep, fill this with the paint, and drop an old spoke into the mass. Now draw this upward gently at the rate of 1 inch a minute, and the coating will flow out uniform. The liquid drains off slowly by natural causes, and this draining operation is about equal to 1 inch a minute. But in doing rims there is a much longer time allowed, which is all the more favorable to the dipping method as applied to rim.

CHINESE NUT OIL IN PHILIPPINES

A small trade in Lumbang or Biao nuts, the oil from which is valuable in making varnish, has sprung up in the islands. The nut grows wild throughout the archipelago, from Luzon to Mindanao, but is seldom gathered or marketed. Traders obtain a small quantity in southern Mindanao from Moros, who exchange the nut for merchandise. The tree grows wild in the islands and produces liberally. It is believed by those who have investigated the subject that if a system could be devised for gathering the nuts enough could be obtained to make a valuable article of export. These nuts are the same as those grown in China from which is produced the "tung" oil, so extensively imported into the United States for use in preparation of varnishes.

RUSSIAN FLAX PRICES LOWER

The flax industry in 1913 was fairly prosperous, though not so successful as in former years. The high prices at the beginning of 1913 (\$176.84 per short ton, as compared with \$159.70 at the beginning of 1912) gradually but steadily declined during the year, except for a slight rise in March.

The principal reason for the decline in prices was the small demand for flax, especially on the part of foreign purchasers. The rapid realization of the crop of 1912, and the extensive exports of flax in that year, which reached record figures, not only supplied the immediate requirements of the foreign manufacturers, but provided them with sufficient raw material for a considerable period. The Russian manufacturers also had secured abundant supplies of flax in 1912 and refrained from purchasing in 1913.

NON-DRIERS

Anything applied to the surface of varnish to better its condition and lengthen its days of service should be in the nature of a non-drying material. For example, raw linseed oil is a drying oil, and under no circumstances should it be used as a renewer or polisher for the automobile finish. Best of all, perhaps, is the material which when applied and wiped up today remains in condition to be wiped again another day. Such a medium which cannot be wiped actually dry, although the surface to the eye may so appear, gives the varnish something to feed upon and permits re-wiping when the carriage returns after a trip over the road. Varnish renovators and renewers, etc., are necessary and useful mediums to be employed in the upkeep of the finished surface, but they should be used discreetly and their quality should be above reproach.

GUM TRAGACANTH

The production of Asia Minor gum tragacanth amounted to 400 tons, but there was little of the pure white or superior quality demanded by the American market. About 200 tons of gum tragacanth, valued approximately at \$125,000, were exported from Mersina in 1912, distributed principally as follows: Austria, \$13,510; France, \$15,536; Germany, \$33,280; Russia, \$20,265; and the United States, \$8,870.

WHEW! WATCH THE SMOKE WHEN THIS HAPPENS

It is admitted by labor leaders that the existing and anticipated quiet of the current year is largely preparation for a coming great struggle. Labor energies are concentrated on strengthening its numerical and financial forces to meet special conditions which will arise at the end of 1914 and in the early months of 1915.

For the first time in the history of coal mining, all agreements between labor and capital throughout Great Britain end at the same time. So also do agreements between the railways and their employes. The minimum-wage act, passed in 1912, for two years, expires by its own terms.

The Miners' Federation and the various railway unions are expected to render mutual support in securing their respective demands. Miners' representatives openly refer to the coming upheaval as a bigger industrial upheaval than the country has ever witnessed.

RUBBER PAVING

Interest in the subject of rubber paving still continues to be manifested in Europe. The London press reports that the underground room at Lloyds (the insurance exchange) is now being covered with a composition of rubber guaranteed to last for 20 years. The committee of the London Metal Exchange are said to be much gratified with the success of their new rubber floor covering; noise and the smell of rubber having been reduced to a minimum. Other specimens of rubber paving are being shown in the west end at 12 Old Bond street and elsewhere.

WANT THEIR BUGGIES BACK

Hearing on a reclamation claim filed by the Durand-Dort Carriage Co., of Flint, Mich., against the Willow Springs (Mo.) Hardware Co., which recently went into bankruptcy, was heard before a referee.

The Michigan concern sold the Willow Springs company a number of buggies and they were on hand when the company became bankrupt. The wholesale house filed a claim asking that they be given the vehicles they had sold, since nothing had been paid on the consignment by the hardware company.

Smith Shop

COAL AND THE FORGE FIRE

Without smithing coal of good quality, iron and steel may be rendered practically useless, hours of hard work go for nothing and the smith's reputation as a workman may be impaired.

This does not mean that all poor smithing can be laid to coal. The fact remains that coal of good quality for smithing is essential to good work, particularly when we come to think how much depends upon it.

The time was when much less was heard of poor coal than at present. Fifteen to twenty years ago coal sold for smithing purposes was much better on an average than it is today.

It is sometimes hard to tell quality by looking at it, but good smithing coal, when a lump has been freshly broken, ought to show a bright, clear black, break easily into cube-shaped pieces, be free from dull, dirty, as well as bright yellow and blue streaks, and should also contain the smallest possible percentage of sulphur, slate, stone or other impurities which combine under heat and form clinker. It is next to impossible to get coal absolutely free from sulphur, but if it does not exceed 1 per cent. its presence is not objectionable, but should it much exceed 1 per cent., difficulty will be experienced in welding.

A good way to try out coal is to build a fair-sized loose fire, turn on a light blast for from one-half to three-quarters of an hour and then shut off the blast and allow the fire to die out gradually. By doing this, whatever impurities it may contain will solidify in the shape of clinker at the bottom of the fire. Then when the blast is shut off, whatever ash forms will settle and can be examined. Any slaty or stony matter can be detected and a good idea of the coal's coking qualities can be had. Such is the experience of Mr. Cran, writing in *American Blacksmith*.

The type of fire generally used by wagon and carriage ironers and others doing the lighter kinds of smithing, is known as a loose fire. To build it, the hearth or firepan is cleaned out, down to the opening of the tuyere. Over the tuyere opening the new fire is started with the coke that has been left over from the previous fire. Fresh or green coal is then placed around it in such manner that the charred fuel is all in the center. As the center of this fire burns, the charred sides are forced inwards and more green coal is placed around the outside. Thus the center is kept well supplied not only with well-charred coke but at a heat almost equal to the hottest part of the fire. This type of fire needs almost constant attention to keep it in proper condition, as the center if allowed to burn out too much allows the cold air from the blast to come into contact with the metal being heated and causes it to oxidize or scale. This is one of the greatest drawbacks to welding or even to clean forging from the solid.

Some blacksmiths have a practice of soaking their coal with water before using it. Some lame excuses are advanced in favor of the practice. Were it possible to burn water on the forge fire or even coal that has been soaked in it there would seem to be some object in wetting it. Water, however, should be convenient to the forge, particularly when using a loose fire with a covered top, so that it can be sprinkled from time to time to keep the flame from breaking through. But apart from that it is useless. Coal fit for blacksmithing will coke perfectly without water, and the greater part of the heat generated goes to heating the material being worked instead of drying out the coal.

MOTOR CARRIAGE PANELS

A. Bates

It appears astonishing that the manufacturers seem to be content to continue using practically the same materials they commenced with for the panel work of motor carriages, especially when such materials present obvious drawbacks to their efficiency. When metal is used for large surfaces, it naturally has to be thin in order to reduce weight and to facilitate its working; this thinness is the cause of excessive vibration which may result in unpleasant noise, but which does prove fatal to the paint, for no matter how well the metal is screwed to the framework, the vibration acting on the paint, which has hardened sufficiently to become non-elastic, frequently causes it to crack away from under the mouldings, which allows the water to penetrate and then the trouble becomes more acute, for in the case of steel, rust is formed which gradually creeps under the paint, bringing it off in flakes, and if the places thus formed are neglected, the process is repeated on a larger and ever larger scale until the whole panel is affected. The coating of steel panels with metallic lead as a preventive of rust has its drawbacks, for no matter how well painted it has a tendency to oxidize, which causes the surface to assume a granular appearance after a few months wear, and the varnish loses its gloss; when it reaches this stage it can be easily scraped off or lifted and the surface is disclosed covered with a fine grey powder which comes off on the finger when passed over it. This powder is, of course, fatal to the adhesion of the priming coat. In any case the lead surface should be scraped and roughened up and colored over immediately before oxidation has had time to take place. This also applies to aluminum panels, as this metal oxidizes very rapidly, which causes the great difficulty in soldering it, the rapid oxidation preventing the solder from taking, special materials being necessary for the purpose. Aluminum is too soft for panels as it dents so easily, and once a large dent is formed it is very difficult to obliterate it, because the metal being soft it stretches so that there is spare metal to dispose of. The only argument in favor of aluminum is its lightness and ease of manipulation.

It is up to the manufacturers to produce something in the nature of a priming which will not leave the metal and which will prevent rusting. Red lead is one of the best pigments for that purpose, but is seldom used by body painters, but, after all, anything of that kind would be only a makeshift remedy. What is wanted is something non-metallic, which will hold the paint; that is, allow the paint to become incorporate with the material itself. Papier mache would be just the kind of thing, but it would only be suitable for flat surfaces. The ideal substance for the purpose would be something that on being damped or warmed could be moulded to any shape or form and affixed to the framework in the ordinary way. This should offer no difficulties to the chemical experts, a combination of gelatine and wood pulp for the damping method of fixing, or gutta percha and pulp for the warming ditto. I do not mean to suggest that either of the two materials mentioned are suitable, but that something of that nature is required. Of course, other substances would have to be incorporated, but that must be worked out by the manufacturer and his chemical assistants. Another argument in favor of such a material would be its non-conductivity of heat and electricity. It is possible that with the metal panel some kind of electrolytic action is set up be-

tween the two metals, viz., the iron and the lead and the lead priming coats. Again, as the granular appearance is more often noticed on the mudguards, which are in direct metallic contact with the chassis, which, in its turn, is frequently used for the return current, it follows that the mudguards are also in the circuit, which may account for the trouble. I say may account for it, not that it does, because it has not been proved either one way or the other, but it is open to investigation; the trouble exists and also the cause. As for the question of heat, there appears to be no cure; the panels of a car left standing in the sun become extremely hot, and, therefore, a great amount of expansion takes place, to which the paint does not respond as it should do, simply because in these days of hurry the color is made to dry quicker, and therefore, it becomes harder and does not possess the elastic properties so necessary to its durability, so we find the surface full of minute cracks. Again, the panel becomes hot and a sudden shower follows, the metal cools down and contracts. This expansion and contraction is not good for the paint, and as the top of the mudguards are more exposed to the heat and rain than are the panels, it follows that they present the worst features of the case. This offers another explanation of the cause of the perishing of the paint and varnish. It is to be hoped that these lines will meet the eye of those who are also interested in the problems under review, and that it may lead to correspondence on the matter which will prove to the benefit of all concerned.—The Decorator.

SETTING THE AXLE TO THE WHEELS

When the two ends of the axle have been pieced up to the required width, it must then be set to the wheels, or if the wheels are re-hooped and the dish altered, it must be re-set. Axle makers go to vast trouble to turn out axles true, but this is thrown away if it is not set true to the wheels, or set to the road as it is sometimes called.

To try the axle, it is placed in position in the wheels, and the wheels pushed right up to the collars, the whole standing on a level floor. Two small sticks are placed on the square of the axle, or on the flaps, and a glance across them will show if the axle is lying flat. Or a "level" may be used. If the axle is not true this way, it must be turned in the wheels a little until it is. Then with a straight edge, iron rod, or a line, the following measurements are taken: (a) From tire to tire, level with the axle at the front and at the back (if these are the same, the wheels are parallel; if not, it will show the amount of "gather" when gather is desired—of which, more anon). (b) From the tire of one wheel to the spoke shoulder of the other wheel, and vice versa, still level with the axle. This is to test if the wheels run square, as they may be parallel to each other and still be somewhat oblique with the body of the vehicle. (c) Measure for the plumb spoke. If the back spokes are required to be plumb, have a back spoke of each wheel at right angle to the ground; if the front spoke is required plumb, a front spoke must be nearest the floor; or if a plumb line is required between the two, have one front and one back spoke down. But the measuring is the same in any case, viz., the distances between the spokes of the two wheels, top and bottom. Now these may show the two plumb spokes to be parallel, but they may still not be plumb, for one may be leaning out as much as the other leans inward. Therefore, also measure, exactly over the axle, from the tire of one wheel to the spoke shoulder of the other wheel, and vice versa. This will show if the wheels are plumb. If any of these pairs of measurements do not agree, the axle must be set accordingly, and when the axle comes to be fixed, the wheels should be slipped on and the measurements run over again to test if the axle is true with the spring blocks. Unless the front and hind eyes of the springs ride level (and they frequently do not) the wood block must be thicker at one end than the other, so that the axle will be square with the ground. Of course, the

axle, blocks and springs, will be clamped together while making this test, and the spring clips fixed when all was found true.

CHARACTER OF A COUNTER SPRING

Any leaf spring is, strictly speaking, a unidirectional spring; that is, it resists the action of an external load in but one direction. Placing a load, for example, at each end of a half-elliptic spring, we find that the spring resists the load (more or less, depending on its capacity) from deflecting the ends downward. The distance the spring deflects and the rate of resistance determine its flexibility. If the load is not too great, then upon its removal, the spring returns without external effort to its initial position. Now, consider the spring to be free; that is, before the load is applied. Let us place on the spring the same load as before except that it is applied to act in an upward direction; that is, away from the other leaves (except the master leaf). We find that the resisting force is now very small. The spring, in other words, is unidirectional or capable of resisting downward efforts only. We call this spring the primary or main spring.

Let us now place on top of this main spring, but in an inverted position, another spring identical with the main spring, except that the main plate has no eyes. If we attempt to apply a load in an upward direction we find that we experience a resistance just as we did a resistance to downward movement in the simple spring. Such a spring has now the property of resisting efforts in both directions.

HIGH-CAMBER SPRINGS

We often hear the terms "high" or "low" or "flat" applied to springs to denote the height of the arc to which the springs are bent. There are no well defined limits of height that suggest logically the use of the above mentioned terms. It may be said, however, that springs whose camber or opening is equal to 1/15 to 1/20 of the length are low or flat springs. Springs having a camber equal to 1/4 to 1/7 of the length may be considered as "high" springs. Spring makers have generally held the opinion that "high" springs are hard and "flat" springs soft. There is some truth in this as we shall show. On the other hand high springs test "soft"; whereas flat ones of the same steel, length of plates, etc., will test much "stiffer." Very high springs may indeed be from 15 to 25 per cent. softer than the corresponding low springs. Clearly then the height of a spring has an important influence on the flexibility.

Springs of very high camber are very sensitive to change in flexibility, owing to the great extent to which they lengthen or shorten as they are loaded or unloaded. Such springs should not be tested for specified deflections below their intended full-load height; doing so will result in anomalous deflections.—D. Landau, in S. A. E. Bulletin.

ASSEMBLING SPRING PLATES

Spring plates go through a number of operations before they are ready for assembling; they have to be forged, pointed, trimmed, slotted, fitted and heat treated. For every one of these operations the plate has to go into the furnace, and every insertion into or removal from the source of heat produces a certain amount of oxide or scale which reduces the working thickness of the plate. The result is that the plates will be thinner than the nominal thickness, by an amount depending on the number of heats they have to suffer. The springs will then test "lighter" or be more flexible than the results called for by calculation. The greater the number of heats, the greater, as a rule, will be the difference between the calculated and the observed flexibility. These conditions are unavoidable. The mill, in which springs are actually designed or calculated, has a "mill factor," so to speak, that

enters into the calculations. Without this it is quite probable that springs of identical dimensions made of the same steel, coming from the same steel plant, but manufactured by two different spring makers, will have different flexibilities.

MORE ACCURACY WANTED

There is no reason why the spring maker also should not demand of the steel mill greater accuracy in the dimensions, particularly the thickness, of the steel. If such a call were met the spring maker would experience less difficulty in making a given lot of springs to a specified flexibility. At the present time, however, there are no fixed standards; the steel maker is not restricted to work within very close limits, with the result that greater liberty is taken in the matter of adhering to specified dimensions than is warranted. However, we will see that even if closer tolerances were specified by one spring maker and these were commonly accepted, the gains to the industry would not be large. Now, even if it were possible to get the steel maker to roll steel of the exact thickness specified, we would still have a finished product the dimensions of which it would be impossible to control with laboratory-like precision. In any case, we must observe that if the deflections recorded in particular cases are greater than expected, the thing to do is to micrometer the plates.

SULPHUR ORE AGAINST STEEL MAKER

The great scarcity of low-sulphur ores is a condition that should be recognized as a limitation to the efforts of the steel maker in his endeavor to meet many of the existing specifications. The absorption by the steel, during the melting period, of sulphur contained in the burning gases in the open-hearth furnace is another handicap to the steel manufacturer in his efforts to obtain very low-sulphur contents. It is well known that all coals carry sulphur as an impurity, and in many cases where very low-sulphur melting scrap and pig iron have been used, the resulting steel contains a higher percentage of sulphur than the original materials from which it is made, the increase being due entirely to the absorption of sulphur from the fuel gases used in melting.

TRACTION NOT THE SAME

An interesting thing has been observed by Mr. Baillie. He finds that the frictional force for large and small swings is not the same. Thus he found, for example, that for a swing of approximately 1 inch the frictional force of a certain spring was 100 pounds when lubricated and 175 pounds when rusty. For a swing of $2\frac{1}{4}$ inches the forces were 46 pounds and 83 pounds, respectively.

AN EXTRA CHARGE FOR CAR "SPOTTING"

The suggestion, growing out of the proposed increase of 5 per cent. in freight rates on eastern railroads, that has come before the Interstate Commerce Commission to the effect that the railroads assess a separate charge for the so-called "spotting" of freight cars, which apparently means placing them on the sidings of companies having private sidings, is of considerable importance, particularly to dealers who constantly receive large shipments of goods by freight. The proposed charge is $7\frac{1}{2}$ cents a ton, with a minimum of \$2 per car, and would represent nearly \$1,500,000 annually in shipments of automobiles alone.

It is proposed to make this arbitrary charge for "spotting" cars as a means of producing efficient additional revenue, instead of increasing the freight rate itself, in the event that the Interstate Commerce Commission decides that the railroads have made out a case which entitles them to a general increase in their transportation charges.

This plan, if adopted, it is explained by General Traffic Manager J. S. Marvin, of the National Automobile Chamber of Commerce, "would inaugurate an entirely new principle of rate making, inasmuch as it would separate the charges for the line haul from the terminal charges. Involved in this question are also the services provided by railroads in the loading and unloading of many kinds of freight, lighterage charges and the delivery of accumulated lots of less carload freight in the so-called 'ferry cars.'" All of these services have heretofore been included in the freight rate to or from the cities in which the factories are located.

Shipping interests appeared before the Interstate Commerce Commission at Washington, February 27 to March 4, giving evidence which would tend to show that factory terminals are an advantage to carriers and that the handling of carload lots to and from these sidings cannot be properly designated as free service. Shippers were a unit against the plan, and particularly against adopting it in haste and without investigation by the Commission at various points throughout the territory, which it is claimed is the only way in which a proper understanding may be had and discrimination avoided.

Marvin appeared for the National Automobile Chamber of Commerce at the hearings before the Commission. Further evidence will be taken by the Commission in connection with lighterage charge at New York and Chicago, tunnel service at the latter city and similar special conditions. The final determination of the matter is not expected for some weeks, and may not be reached for months.

THE MOTOR CAR IN THE SEVENTEENTH CENTURY

The motor industry was but a vision in the seventeenth century and it was years later before this vision began to be realized and the industry as it stands today is practically all the development of the last quarter of a century.

It hardly seems possible that the first automobile factory in the United States was started 22 years ago; nevertheless this was a fact. In 1892 the first American factory was established by J. Frank Duryea, at Springfield, Mass. Since that time there are over 500 factories with an estimated yearly output of 350,000 cars. This certainly is a fulfillment of the prophecies of Roger Bacon, made in the thirteenth century, that steamships, horseless carriages and flying machines would soon be common.

The first experiment with horseless carriages that met with any degree of success, were made in the 17th century. Johann Haustach, of Nuremberg, constructed a carriage propelled by springs at this early date. There was no steering device attached to the mechanism, but the car would travel in a straight line when wound up.

During the same period, vehicles, to which were attached sails, were used in Holland. These would run only on level ground. In 1619 another spring-driven carriage termed in the patent paper as a "cart without horses," was patented in England, and in 1644 a French patent was issued on a four-wheel carriage propelled by foot power, on the same principle as was later used on the bicycle.

In 1748 a carriage, propelled by clockwork, was exhibited before Louis XV of France.

Several others experimented along the spring drive line up to the year 1800, but with little success. It had been discovered that steam could be used as a motive power and clock work devices were discarded in favor of the new found power.

Steam was first used in a road carriage in Pekin, China, in the year 1630. History credits Father Verbiest, a missionary, with achieving this feat. This was followed in 1680 by Sir Isaac Newton's steam carriage.

Various experiments followed Newton's carriage, but as a peculiar coincidence, development was carried on in France.

In 1769 Nicholas Cugnot, backed by the French government, constructed a steam gun carriage.

This was a three-wheel contrivance equipped with a two-cylinder engine that carried two and one-half tons and traveled three miles per hour. The French revolution put a stop to further development along this line.

In 1784, James Watt patented an invention for driving carriages by steam but did nothing toward building or experimenting.

Just prior to this, in 1781, William Murdock, a pupil of Watt, had built a steam carriage, and it is supposed the patent was taken out on this vehicle.

In 1787, Oliver Evans, of Maryland, invented a steam road wagon, and Nathaniel Reed, in 1790, at Pecousic, Mass., constructed a combined road wagon and boat, carrying on his experimental work on the banks of the Connecticut. Evans and Reed were the first ones to really build steam carriages in this country that would successfully propel themselves under their own power. Reed's wagon was, no doubt, developed from an endeavor to successfully navigate the Connecticut, and, since a power was devised that would operate paddle wheels the attempt was made to harness them to the road wheels of the ordinary wagon.

The first steam carriage in which the crank shaft was geared to the drive wheel was invented by Richard Trevithick in England in 1802.

In 1822, Sir Goldsworthy Gurney began working upon six-wheel steam carriages, and in 1831 a Gurney carriage route was established between Cheltenham and Gloucester, England. This carriage was capable of running 12 miles an hour. After four months' time the service was discontinued because of public opposition.

While Gurney was working on his carriage Walter Hancock established a steam omnibus line in 1829. His was the first chain transmission vehicle invented. Five of these carriages were run between Paddington and Stratford in 1836. In 12 weeks 12,760 passengers were carried. This line was practically forced out of business by the English government. In that year a toll law was passed with taxes so high none could afford to run cars. Because of this law further development of the horseless carriage was prohibited and very little along this line was done until the repeal of the law in 1846.

Turning to France, the country that is making the aeroplane the traveling car of the future, we find in 1878, a steam carriage was built by Amedee Bollee, of Mans, France, and two years later he constructed "La Nouvelle." This car was run a distance of 745 miles in 90 hours, as late as 1895.

In 1886 the first gasoline engines were used on road vehicles. These were the invention of Carl Benz and Gottlieb Daimler, of Germany. In 1889 the two-cylinder engine was invented by Daimler, and Messrs. Panhard and Levassor, of Paris, immediately acquired the patents and built around the engine the first real gasoline motor car.

The Panhard car was quickly followed by the Renault Freres and the Benz. Then factories began springing up in France, Germany, England and the United States, and so successful were the gasoline motors that in 1894 and 1895 the power machines were proclaimed a success. To J. Frank Duryea belongs the distinction of being the first American to turn out a successful motor driven vehicle. The first car was completed at Springfield, Mass., in 1891, and was equipped with a one cylinder motor, but in 1894 a vehicle was built propelled by two cylinders. Details were improved and appearance of the car was changed from that of the high-wheel buggy to a moderate sized pneumatic tired wheel. In this evolution 15 cars were made and sold, which were the first to be placed in the hands of the public by any manufacturer.

In the United States the annual production of inflated tires is put at ten millions.

WHAT IS A COMMERCIAL MOTOR?

The inquiry has its origin in the fact that at the shows in New York and Chicago there are to be no commercial vehicles. Such being the case, it follows that in order to exclude commercial motor vehicles it must be known just what commercial motor vehicles are.

There has been some doubt as to whether certain types of motor vehicles should be classified as commercial vehicles or not. For example, the taxicab may be used either as a private town car or for hire as a public conveyance; so may the station wagon and the motor stage. Many persons do not rank motor fire apparatus as motor trucks or commercial vehicles, because it does not carry merchandise. The funeral car is another vehicle that occupies an uncertain position. There are also special service machines, such as emergency wagons, tower wagons, and fire chiefs' cars, that seem to constitute an intermediate class between the pleasure or passenger car and the commercial vehicle.

The need for a clear-cut definition of a commercial motor vehicle was therefore considered at a meeting of the commercial vehicle committee of the Automobile Chamber of Commerce, with the result that this one was recommended to the board of directors:

"A commercial motor vehicle is a self-propelled vehicle designed to be operated without rails for the primary purpose of transporting materials, products, passengers or apparatus especially for business purposes or for hire, profit, emergency work or special utility service as distinguished from private personal use by the owner or renter for enjoyment or convenience."

CURVED LINES AND CONTOURS

The curved outline and contour has had a long innings in the world of motor body design, and one is apt to wonder if the angular type will ever become popular again. Here and there one sees an angular limousine or landaulette with the usual stream-line scuttle, but seldom is the angularity carried out as systematically as with, say, a Peter's brougham. A few angles here and there, however, make a pleasing relief to the motor body of today when they are used, even if only adapted for a dash handle, a pillar lamp, the outline of the radiator, and so on. So far the majority of long side steps are rectangular, while wind screens and lights must, on the whole, follow a similar outline.

PRIZE FOR NONRUBBER AUTOMOBILE TIRE

Consul General Charles Denby, Vienna, says the Ministry of War has offered \$10,000 as a prize to be awarded to the person who will, with adherence to certain prescribed conditions, construct an elastic tire for motor freight wagons. Besides the specific attributes of pure rubber, such as elasticity and adhesiveness, the new material must possess (1) essentially greater durability, or (2) with equal durability the attribute of essentially smaller cost of construction than the rubber tires, thereby reducing the expense of operating motor freight wagons. Its weight must not exceed that of the pure rubber tire.

BENEFIT OF WIDE TIRES

The use of wide tires on wagons, says A. F. Woods, dean of the department of agriculture, University of Minnesota, has made hauling easier and improved and packed rather than cut ruts in the roads. The farmer who still uses narrow tires for heavy loads is not only wasting time and horse energy, but is guilty of cruelty to animals and the destruction of the public highways. The relation between weight of load and width of tire and the maintenance of roads in each section should be carefully considered and fixed by local regulations.

Wood-Working Shop

BANNISTER ON WHEELS

O. B. Bannister is conceded to be a doctor of laws on wheels. His degree would pass muster in any college of wheel makers. He has recently written a book on wheels, and we crib some of the good things said in the true Bannister style. Apologies to the copyright.

There are certain fundamental elements in the manufacture of wheels and in the selection of the material for them of which the wheelmaker must have a practical knowledge, that the goods may be made right.

First, and most important, is to select the right kind and quality of material. For light wheels, hickory is the only material that has been discovered up to the present time which is satisfactory. But even in hickory, all material is not satisfactory for good work.

In the hickory family there are old and infirm trees that have reached a period where they have commenced to decline—the wood of which is good only for firewood. Then there are middle aged and young trees, the wood of which is capable of standing almost any reasonable service that may be required, provided that it is prepared and protected as it should be. It is from this class of material, found in these middle aged and young trees, that good wheels are made. Even in these two classes of trees, material is found which differs widely in strength and toughness—the two principal factors which determine the quality of stock. This fact makes it necessary to find the proper basis for correctly judging stock.

Formerly, stock selection was based largely upon color—it being believed that white stock was better than the red. This tradition was found to be false, and was thoroughly exploded by the results of mechanical tests, initiated by the Muncie Wheel Co., who furnished spoke material for the tests, and carried out in co-operation with the United States Forest Service, at their testing plant at Purdue University, Lafayette, Ind.

The results of these tests proved conclusively that red hickory of equal dry weight is just as good as the white, or in other words, that color is no basis for grading, but that weight alone, defects being considered out, is the true basis.

For example: The spokes which were furnished by the Muncie Wheel Co. to the government, being graded upon the color basis, were found to be as much as 50 per cent. in error when the weight basis was taken, and the weight basis was found to govern the strength and resilience factor.

To illustrate: Some spokes which had been classed as "D," or fourth grade, on account of their red color, were fifty per cent. greater in strength than some spokes which were of a lighter weight, but which had been classed as "C" or, third grade, on account of their white color.

Generally speaking, heart wood in most all species is considered to be more durable than sap wood, and it is argued by some that red hickory is more durable than white. All red hickory was at one time, during the growth of the tree, white. Its change in color is due to the infiltration of lignin (nature's process of changing a "boy tree" to a "man tree") in the cells and cell walls, and this action gives to a certain extent a great density per cubic unit of wood; thus reducing the water-holding capacity and retarding the permeability with respect to absorbing moisture.

The mechanical tests referred to show the fallacy of prejudices that exist in the trade and help to eliminate them, but most important of all, the tests give the manufacturer of wheels

the necessary knowledge which enable him to serve the buggy manufacturer to the best advantage, in that the wheel manufacturer is enabled to give the buggy man the proper quality of stock and have it properly graded, and thus he has the fundamental elements upon which to build in each of the mechanical steps which follow in making the finished wheels.

Weight, True Basis of Grading

It can, therefore, be seen that the true basis of grading for service is the basis of weight.

After the material for wheels is carefully selected as to quality and size, then it is thoroughly seasoned and prepared in the most modern and scientific way, so that when it is ready for the wheel, it is matched as to quality and strength, ready to do the service required of it, whether it be driving or hauling.

Good material carefully matched and selected alone does not make a good wheel; it must be mechanically put together. A carpenter may be able to build a fine house, but it requires the best of machinery and technically skilled mechanics who are trained in their work to produce a good wheel.

All of this care upon the part of the wheel manufacturer will count for little if the carriage manufacturer and the user of the vehicle fail to do their duty in taking proper care of the wheel.

The priming of wheels involves the physical principles employed in the open tank method of treating timber with creosote. In this work the timber is first thoroughly dried and then boiled in the treating mixture until it is heated through, which causes a partial vacuum in the cells. It is then immersed in a cold bath of the mixture which causes a contraction of the air in the cells and a consequent "sucking in" of the mixture. By this method a penetration of one-half to two inches, as desired, is secured.

All wheels when finished should be given a coat of oil and lead primer at the wheel factory before shipping, as wheels are made from thoroughly seasoned stock in a temperature that does not admit of any moisture, and when they leave the hands of the wheel finisher they are highly polished, smooth and dry, the cells have become opened through the drying process, by the expansion of the heated air in the cells, and thus a partial vacuum is formed, that is, the wood is in its most absorptive condition, and this is the time to fill the pores with primer. If it is neglected, and they are shipped without priming, the effect of a change to a cold, damp atmosphere, such as they are subject to in the ordinary freight car, is to rapidly fill the pores of the wood with moisture, causing the wood to swell and the grain to rise.

THE TRUTH AT LAST

It tickles us "mos to def" to quote what follows from Mr. W. H. Emond, the body draftsman of the Franklin Automobile Co. What he says has, of course, been the truth always, but the gentlemen in charge of the tea kettle end of the enterprise always imagined the engineer to be the superior and omniscient worthy, and the blanch, tray and sweethearts of the auto press—well, how could they be expected to know. What Mr. Emond says is real interesting. He must have been bred an actual carriage body builder draftsman, not a mere engineer with an idea that an auto body is just a tin can proposition, of no consequence so long as a poppet valve makes a noise.

"The important practical function of an automobile body is to carry passengers comfortably. To obtain passenger comfort dimensions must be right for normal human beings, cush-

ion springs should be so constructed as to carry their load without bottoming on rough roads, and back upholstery must be so shaped as to conform to the human figure, relieve it from severe shock and make it unnecessary for the passenger to repeatedly shift about on a long ride in an effort to obtain an easy position. This last is the real test of upholstery design.

"There is, however, beside the mere body dimensions, and beside the relative merits of different spring suspensions, a still more important element for consideration in designing a car for riding comfort, and that is the general assembly, taking into account the distribution of the weight above the springs and axles—to make it plain, the position of the wheels with reference to the load both of passengers and machinery.

"For the benefit of the engine and for ease of steering, assembly designers found years ago that it was essential to place the front wheel well forward; usually, in a water-cooled car, on a line with the front of the radiator. For a similar consideration of passengers, European assembly designers are today placing the rear wheel well back, and the body designer, who in Europe is largely the assembly authority also, contributes further to comfort by keeping his passenger load well forward, allowing, of course, generous foot room, but no more.

"The manufacturers of many American cars seem not to have considered this matter of general assembly design at all, so far as passenger comfort is concerned. The method seems to have been to place the front wheel according to accepted practice, then to make up their minds they will produce and advertise a certain number of inches wheel base, and on a chassis so designed, place a body with a long tonneau compartment which projects the seat load far back of the rear axle.

"It is no wonder that a car so designed will completely use up its passengers within 200 miles on just good average roads, even without considering the spring suspension. Every rough spot will throw the passengers off the seat, at a speed of 25 miles, and yet this long, roomy tonneau is featured as of great benefit to the prospective buyer. There is plenty of room for suit cases and other baggage in the tonneau, forward of the passengers' feet—in fact, the luggage has the most comfortable spot in the body while the passengers are tossed about in the overhang.

"Owing to the fact that European carrosserie designers have in the last two years turned out a variety of bodies having the shells built to enclose tires, wheels, folded tops and general luggage, in rear of the passenger compartments, the automobilists' eye has become accustomed to a considerable back overhang. In fact, when lines are well drawn a considerable overhang is not objectionable in itself so far as appearance goes, but to place human beings out on the end of such a spring board and play snap-the-whip with them is nothing less than cruelty to the race."

JOINTING WHEELS

The above term is understood to mean to cut away a small portion of the rim or felloe at one or more joints to allow all the separate parts of the wheel when tired to come together true and tight, and without unnecessary strain on any one part. If you do not cut out enough joint, the wheel will soon become what is called rim bound, the tire will be tight, all the joints in the rim (whether it be in two bent parts or in felloes) will be tight, but the rim will be standing off the spokes at the shoulder of the tang; the tangs may at the same time be loose in the rim and the spokes may be loose in the hub. To make a long story short, the rim is too big for the wheel and requires sufficient joint taken out to allow it to come down hard on the spokes at the tang and cause the spokes (if loose in the hub) to come down hard on to the hub if shouldered spokes, and to sink home into the hub if tapered.

With an old wheel that is loose all over, and time and funds not allowing you to take it to pieces, it is often a difficult job to cut out exactly the joint that is required. But in the case

of new wheels there can be no excuse, as the wheel is sound and you have every opportunity of judging the quality of the material used in its construction.

There is no rule as to what amount of joint a wheel should have in it before it is tired any more than the amount of tightness that the tire should have can be laid down by rule. They are both matters requiring careful judgment, which can only be acquired by observation and experience. Those who lack the qualifications can never become experts.

The wheel should be solid and sound in itself before it is tired. The spokes should be tight in the hub, and the tangs should be tight in the rim. The rim should be down solid and true on the shoulder of the spokes at the tang. The end of the tang should be a shade lower than the tread of the rim; so that when the tire is on, the rim will be down solid on the shoulder of the spoke at the same time as the end of the tang is flush with the tread of the wheel and resting on the tire.

If you cut the end of the tang too much below the tread of the wheel, the pressure of the tire and the load comes on the rim, and, if the spoke is dressed a bit light at the top, it is no time before it has squeezed into the rim and the end of the tang resting on the tire. If it is a heavy dressed spoke and has a good bearing on the rim, the pressure will cause the rim to squash out sideways. Of course, if you have a good solid spoke and a good shoulder at the tang with a hard dry rim or felloe, it will stand even if the spoke had only half a tang. But what we want to do is to lay down a rule which is at least generally correct and recognized as the right method.

To get good results it is necessary that the wheel should be dry before it is tired. It is not a wise plan to put on a tire extra tight if you know the material in the wheel is a bit fresh. A tight tire will not stop a wheel from shrinking; it will only squeeze up the soft wood for the time being.—Australasian Coachbuilder.

THE BODY IN CYCLECAR DESIGN—THE EFFECT OF RESISTANCE AND WEIGHT ON ECONOMICAL RUNNING

Definitions apart, the object of the cyclecar is to provide two persons having a small amount of luggage (or perhaps three people having no luggage) with the means of transport over certain distances at reasonable speeds and in comfort, approximating to that of one's fireside chair. The chief factor appealing to the purchasing public is the whole cost by which this desirable end can be attained, says *The Light Car and Cyclecar*.

Two considerations that bulk largely, in the designer's eyes, are resistance and weight. Resistance may be split up into that of the road, the grade, the windage and the internal resistance of the mechanism. Weight is made up of the useful load, i. e., the passengers, the body, the equipment and the chassis.

Resistance is to a large extent a function of the weight. Weight is a deadly foe to speed and economy. It is important that weight should be reduced as much as possible.

Of the quantities that go to make up the gross weight of the vehicle the least amenable to reduction is the useful load—the passengers. This is one of the first points in which the body influence is felt.

Weight is to a very great extent proportionate to the size of the vehicle, yet it is impossible to cut down seating width to less than 17 inches per person, and it is useful to allow 19 inches. A 19 inch seat width represents, at a minimum, a width over the body panels of 44 inches, and this immediately calls for a consideration of wind resistance.

Bodies to give good results in this connection ask for certain treatment regarding their lines. The sizes induced thereby again affect the weight of the body and of the chassis.

Chassis weight depends to a great extent on the load super-

imposed; the mechanical portion of the machine can be calculated correctly if the premises upon which the calculations are based are correct in the first place. The body, on the other hand, does not lend itself to calculation, and its weight, like the weight of the equipment, is very often a surprise to those responsible for it.

The cyclecar weight limit of 784 lbs. imposed to accommodate those machines the bodies of which are inseparable from the chassis, or form the frame structure proper, less the allowance of 672 lbs. for the chassis, leaves 112 lbs. margin for the body. It is a very difficult thing to make a reasonable side-by-side two-seater body with tool accommodation to weigh 112 lbs. With screen and hood, without which or its equivalent no body is practicable, and allowing a reasonable but not excessive seat width, it is very easy to total twice that allowance.

It is interesting to note that the passenger vehicle having the best ratio of useful to dead load is the London general omnibus, where the weight of passengers carried is approximately the same as that of the vehicle itself, whereas in the example taken the weight of the body plus the equipment would more than outbalance that of the passengers. (Incidentally, this is an argument for lightening the equipment.)

The body, again, has a good deal to do with the distribution of the load, which in its turn has to be considered in the designing of the mechanism.

Summing up, the body should receive first attention from the designer, even though it is not one of the primary engineering problems of the cyclecar. The reasons being (1) that since it is so intimately associated with the passengers and their comfort, a great deal of subsequent design is subservient to it. (2) The size of the body rules within limits the size, and hence the weight of the chassis. (3) It is a great absorber of power in that it has more area for wind resistance than any part of the car. (4) It is an unknown quantity, both as to its actual weight and the distribution of the load, which considered as everything on top of the actual machine can never be much less than a quarter of a ton. (5) It would also appear that a great deal of weight could yet be saved in body construction.

AN INVENTION IN BODY SHAPING

A recent invention of H. E. Scrutton (formerly manager with Messrs. J. A. Lawton Co., England) promises to exercise very material influence on the future development of body building. Mr. Scrutton in effect has discovered a process by which wood can be rendered so pliable that it can be bent or shaped both with and across the grain at the same time; in fact, by his process wood panels may be shaped to take the place of beaten panels.

What possible saving in cost this process offers we should hesitate to say, for conditions must inevitably exercise a great influence on this question, but we should imagine that the general all-round figure of 15 per cent. saving claimed by the inventor is a decidedly conservative estimate. The invention originated in difficulties that Mr. Scrutton experienced with his panel beaters—a state of things which led him to devise some way of avoiding the trouble.

The process is simple and quick, for it consists of subjecting the wood to two separate processes of chemical treatment, after which it becomes pliable. All traces of the chemical treatment are then washed out, leaving the wood as hard as in its natural state.

Some pieces that had been treated, both $\frac{1}{4}$ in. mahogany and white wood, were found to be more like leather than anything else along the grain, while across the grain, though they were far stiffer, they could be bent to a considerable extent merely with the strength of the fingers. In actual practice, bending is done either in a light screw press, or by shaping the panel to temporary battens on the body.

A sweeping invention like this lends itself to other advantages. There is no need to emphasize the conditions that are claimed

in the painting of wood as compared with metal panels, but it is as well to point out that the chemicals are emphatically stated to be non-injurious alike to the structure of the wood, to paint, or to French polish.—Cooper's Journal.

AMUSING TO NOTE

It is amusing to note that some motorists are grumbling about the disadvantages of the low-sided streamline body with cushions on the floor. The joke lies in the fact that the complaint is made in terms which must impress the onlooker that one is forced to have a "sporting" type whether one likes it or not. A writer in *The Autocar* says: "Can our manufacturers provide us with nothing better in the form of an open car than a hideous cross between a bottle and a bath tub, the unfortunate occupants of which have to sit on the floor behind a screen which not only affords them no protection, but seems to have been specially designed for the production of a maximum of cyclonic draught? By all means let our body builders cater for the 'nut,' and for the female of that species, who is 'more deadly than the male,' but for heaven's sake let them remember that there are still a few individuals left to whom comfort is more important than 'swank.'"

We have always understood that practically all the exaggerated types of bodies were built to order, and we know of no law which compels a motorist to have even a standard body, since we are being continually reminded that the whole individuality of the motor body building trade is bound up with the design and manufacture of the motor body built to the special requirements of each customer. One cannot argue either that expense compels one to have an ultra-fashionable body, since cars with seats which do not encourage lounging are cheaper than those which do.

WOOD SHOP WRINKLES

A file may be kept from filling up with lead by applying a coat of thin oil just before filing.

A piece of sandpaper or emery cloth is an excellent thing to keep near a gasoline or kerosene can to remove the cap when it is stuck.

Grease a hard running saw with kerosene. This oil will not stain the wood.

Glue that is forced out of a mortise point and allowed to become dry and hard, can be easily removed with a sharp chisel dipped in oil.

Iron or steel may be made rustproof by boiling in a mixture made of one gallon of water to which is added four ounces of phosphoric acid and one ounce of iron filings.

Where oil will not act as a cooling agent on a drill when working in hard metals, turpentine used instead will permit the drill to take hold and retain its temper.

A NEW BLIGHT

California state inspectors at San Francisco have found a new canker disease on chestnut trees recently imported from Japan. According to Dr. Haven Metcalf, the government's expert on such diseases, this appears to be of the same type as the chestnut blight which is ravaging the forests of the eastern United States, and it is possible that the new disease would be equally as destructive if it became established in this country.

GLASS LIFTS FOR FRAMELESS WINDOWS

Little lifts of glass to be affixed to frameless windows are much in evidence. They can be formed to suit the fancy of the customer, if desired.

A new way is to take a piece out of the glass in place of putting a knob or lift onto the glass. They have many advan-

tages. They are perfectly flush with the surface of the glass and there is nothing that can get out of order. Nearly all frameless windows have some kind of spring arrangement to lift them up, and very little pressure is required in the way of lifting. This simple lift provides ample means for the necessary pressure either up or down.

REMARKABLE RANGE OF USE

Almost every use to which land may be put is represented in the permits reported by the forest service for special projects on the national forests. Some of the uses range from apiary through brickyard, cannery, cemetery, church, cranberry marsh, fox ranch, marine railway, rifle range, and turpentine still, to wharf and whaling station.

There are 15,000 permits in force for such special uses, which are distributed from Alaska to the Mexican line, and east to Florida. This figure does not include any of the 27,000 permits in force for grazing, nor the 6,000 transactions for the sale of timber, and the more than 38,000 permits issued last year for the free use of timber by settlers, miners, and other in developing their homesteads and claims; nor the nearly 300 permits for water power development.

"GATHER"

The object of gathering wheels is to make them run on the collar of the axle, and is usually considered necessary to prevent the bush being drawn and to prevent wear of the collet.

STILL ONE MORE FORD IMPROVEMENT (?)

Flat steel springs 9 feet long, coiled, consisting of four sets, two for each leaf spring of the car, have made their appearance, which work under compression at all times. Rebound is checked when the leaf spring rises above a certain point, the main lever of the shock absorber is held stationary, and the

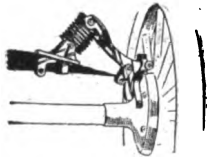

coil springs are again compressed, so that both upward and downward movements actuate the coil. This novel shock absorber has been found so sensitive that when the car is unoccupied the pressure of the hand will move the car body on the coils. Spring perches are used to attach the absorber, being reversed on the front axles, while on the rear they are bolted to the brake housings.

MAGNALIUM FOR PISTONS

Magnalium, an alloy of aluminum and magnesium, is lighter than aluminum. For some years magnalium has been used successfully for cylinders of gasoline engines where weight was of great importance, particularly for aeroplane work. Having stood the wear of piston travel when used as a cylinder with an iron piston, it naturally followed that if a magnalium piston were used in an iron cylinder it ought to answer the purpose. This has been tried by a number of people in a number of motors under all kinds of conditions. The specific gravity of magnalium is 2.5; that of pure aluminum is 2.56.

The specific gravity of aluminum alloy No. 12 is 2.82; that of cast iron is 7.50.

The ordinary grade of cast iron used for pistons has a tensile strength of 18,000 to 20,000 lbs. per sq. in. Magnalium has a tensile strength of about 23,000 lbs. per sq. in., and is very tough, whereas cast iron is rather brittle. Magnalium is not

as hard as iron, but is a better bearing metal. Experiments have shown that it is even better bearing metal than bronze or babbitt. At 280 revolutions per minute, under a pressure of 250 lbs. per sq. in., the coefficient of friction of true babbitt is .0075, of phosphor bronze .0069, and magnalium .0056.

A BLOW FOR MILADY

A diminutive electric fan, especially designed to ventilate the interior of a closed automobile, is a French novelty. The double-jointed mounting provided with the fan permits one

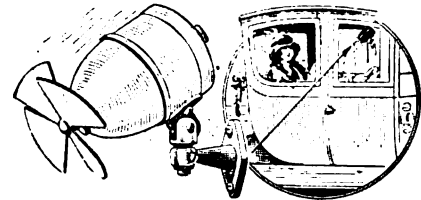

to direct the air current toward any part of the car. The motor is completely inclosed, so there is no leakage of lubricant and the fan is self-contained in an aluminum body. It uses but little energy and takes up very little room.

NOT A NON-POPPET VALVE YEAR

This cannot be considered a non-poppet valve year, despite the fact that the Knight motor has no difficulty in holding its own. Perhaps it would be more correct to say that poppet valve motors have improved in such an amazing manner during the past few years that a non-poppet valve type must be remarkably good to equal them. In the matter of silence there is nothing to choose between the two; it cannot be maintained that the poppet valve is less efficient, and under a cost basis the advantage is in most cases with the poppet.

TOO MUCH POWER

In the demand for lighter cars the motorist is apt to forget that a smaller engine is required. When it comes to the so-called cyclecar, horsepower of 15 and even more are mentioned, and in this lies a danger. To place in the hands of a novice a 15 or 20 horsepower motor, hitched to a vehicle weighing only about 500 pounds, is equivalent to wrecking the car in short order. Such a motor is capable of forcing the car over rough country roads at speeds which are detrimental to mechanism.

FORMERLY BUGGIES, NOW BASEBALL

National interest is being awakened in the St. Louis American league team because of the unique methods that have been and are being adopted by President Hedges and Manager Rickey.

Colonel Robert L. Hedges, owner of the club, was formerly a Hamilton (O.) man. He was secretary and treasurer of the Columbia Carriage Co., from the organization of the company in 1890 till 1898 when he disposed of his interests and went to Kansas City.

HIGH MORTALITY OF AUTO BILLS

Only 23 out of 182 introduced have become laws. Eight legislatures adjourned with much relief to everybody interested in automobiles and motor trucks, according to a report just issued by the American Automobile Association showing the present status of motor vehicles and highway legislation.

No drastic or very objectionable measure has been enacted in any state, but a number of bills approved by automobilists have been enacted.

PANAMA-PACIFIC EXPOSITION

Information for Exhibitors in Machinery Department

Free Space: There is no charge for exhibit space, but space occupied must be properly and economically utilized.

Transportation: Exhibits may be consigned directly to the space to be occupied, through the Exposition Terminal Railway Co., which will receive and transfer exhibits from the terminals of the trans-continental and steamship lines, making a charge of 15 cents per 100 lbs.

A one-way freight charge will cover return of all exhibits over trans-continental lines to point of origin.

The Exposition Terminal Railway Co. will provide at Chicago and other eastern points, warehouses to receive less than carload shipments that will be combined in carload lots and shipped direct to the exposition, thereby securing carload rates.

All consumers must purchase water on a meter basis.

Alternating Current Power Service: In the Palace of Machinery there will be available for power purposes 60-cycle, single-phase and three-phase current at an approximate voltage of 230.

Single-phase motors must not be over 1 h.p. in size if served at 115 volts nor over 5 h.p. if served at 230 volts.

Direct Current Power Service: Direct current at approximately 125 and 250 volts will be available in the Palace of Machinery.

Steam Service: Steam service will be available in the Machinery Building during the hours that the building is open to the public. Saturated steam at a pressure of approximately 150 lbs. per square inch will be furnished. Headers and mains for live steam, exhaust steam, drips and drains will be installed by the exposition. Participants requiring steam must arrange for service in advance.

Compressed Air Service: A limited amount of compressed air at 80 pounds pressure will be available in the Palace of Machinery. Compressed air service must be arranged for in advance.

Space Application: Applications for exhibit space will be given precedence according to date of receipt. At the present time it is only necessary for the applicant to state approximate amount of space desired. Detailed plans showing arrangements of exhibits can be sent in later when the final allotments of space are made.

BROKERS TO OPERATE MITCHELL WAGON BUSINESS

Instead of having been sold to the International Harvester Co., the wagon business of the Mitchell-Lewis Motor Co. is now in the hands of White, Weld & Co., New York bankers, and a number of their associates; the bankers, however, are the principal owners, and while they were believed in some quarters to have acted as brokers in the matter, they declare they acted for themselves alone and will operate the wagon business, temporarily, at least.

The sale was the outgrowth of a \$2,500,000 note issue late in 1911. White, Weld & Co. taking a portion of the paper and disposing of a part of it to some of its clients; the remainder was taken by Chicago interests, but White, Weld & Co. acted a major part in the transaction and has since acted as the Mitchell-Lewis bankers.

In August, 1912, when the \$2,500,000 fell due, \$750,000 was paid and the remaining \$1,750,000 was extended for a year. In August, 1913, the company was able to pay but \$250,000 and the remaining \$1,500,000 was extended to August, 1914. Various business reverses of an internal nature had made the maturing obligations a burden and it was questionable whether they could be met next August; neither was it deemed advisable to request a further extension.

In this emergency White, Weld & Co. and their clients who

held Mitchell-Lewis paper agreed to exchange their notes for interests in the wagon business, which was made a separate corporation.

MOTOR OUTFIT GOES FOR \$110,000

Samuel L. Winternitz & Co., of Chicago, auctioneers, were the highest bidders at the sale of the plant of the American Motors Co. Their bid was \$110,000, but the sale is subject to the approval of Judge Albert B. Anderson, of the United States court in which the American receivership and bankruptcy proceedings are pending.

Samuel Winternitz announced that it is the intention of his company to resell the property at public sale piecemeal, which means that the American underslung automobile will pass out of existence. The sale was conducted by A. Greenwald, auctioneer, for Frank E. Smith, receiver. The plant had been appraised at \$94,000, and the terms of the sale were \$20,000 deposited at the time of the sale and the remainder to be paid in ten days.

There were about 20 bidders, and the bidding was spirited until toward the last, when it narrowed down to the successful bidder and Mr. Finnegan, of Buffalo, N. Y., who bought the property of the E. R. Thomas Motor Car Co. some time ago.

Samuel L. Winternitz & Co. have bought several motor car plants during the last few months, among the number being that of the Michigan Buggy Co., Kalamazoo, Mich.; the Falcar plant, the Midland plant, the Grabowsky truck plant, and others. There was no real estate involved in the American sale.

FIRST YEAR OF BRITISH UNEMPLOYMENT INSURANCE

Consul General John L. Griffiths, London, says the report for the first year of the operation of the Unemployment Insurance Law under which provision is made during periods of unemployment and illness for the great body of employes in the United Kingdom shows that 2,508,939 unemployment books were issued; 559,021 claims for benefit were filed; 400,000 individual working men claimed benefits under the act; 774,494 payments were made; the total benefits aggregated \$1,150,722; the lowest payment for any one week was \$23.359 and the highest \$93.436; the year's gross income amounted to \$11,039,168; at the close of the year there was an invested balance of \$7,835,055; the maximum of unemployed falling within the provisions of the act was 118,000; and the minimum, 67,000.

Of the total annual income derived under the insurance act, the employers and workmen contributed about three-quarters and the state one-quarter. In a large proportion of cases the unemployment was very short, 30 per cent. falling within the waiting week during which no claim could be made, 62 per cent. received benefits, while 7 per cent. was excluded for various reasons, and 1 per cent. represented unemployment which continued after the period during which benefits are paid.

It is stated that the report is only preliminary in certain respects, as some of the figures have not been fully and definitely analyzed. It is to be noted also that while the insurance law has been in operation for a year, there has been only six months experience of the payment of unemployment benefits.

GOODYEAR RETIRING FROM RETAIL DISTRIBUTION

Following the trend in the tire trade, the Goodyear Tire & Rubber Co. retired from the retailing field April 1. After that date no car owner can buy a tire over the counter in any of the company's 60 retail branches.

The business done by the branches will be exclusively wholesale, as has been the case with the United States Tire Co. since its consolidation in 1911. Other tire makers have felt this trade trend, but none of the others contemplate such action

in the immediate future, although the elimination of retailing, it is stated, undoubtedly will eventually come along the whole line.

The Goodyear move was made to enable the manufacturer not to be a competitor of the dealer and also because of the decline in retail business. Cut prices by tire dealers are said to have made the strictly list price trade of the manufacturers' branches very small, one branch man stating that he did not make 10 retail sales a year.

STRIKE STILL STRIKING

The committee in charge of the strike at the Keystone Vehicle Co.'s plant ask the publication of the following statement: "The strike is still on (March 25) at the Keystone Vehicle Co.'s plant. On Wednesday there were but 32 men at work. Three of them were new ones. There was very little work in some departments, which are almost tied up. The strikers still stick for what they did in the beginning. We demand that the reduction of 10 per cent. be lifted from the men, and if any men have the reduction taken off already, to be reimbursed. The committee appointed to see or act in conjunction with the firm is ready to see or correspond with any member of the firm and can be seen at the Labor Lyceum. Another meeting will be held Friday morning at 9 o'clock at the Labor Lyceum."

OLDS AGAIN BUILDS FOURS

The Olds Motor Works, Lansing, Mich., announces that it will soon be in the market with a four-cylinder model to be a running mate of the present six. In making this move the Olds concern returns to its first type of vehicle, and gets the benefit of the good will which this car created.

The new Oldsmobile will be about the same in general appearance as the present six but its wheelbase will be shorter—110 inches.

THRUPP AND MABERLEY EXPANSION

Selfridges will take over the premises of Thrupp and Maberley, Oxford street, London. Thrupp and Maberley are erecting a thoroughly modern factory of ample size in the Edgware road, which, when complete, will enable them to deal with the rapidly increasing business. They are also retaining the major portion of the ground floor frontage and the greater part of the basement in Oxford street, the remainder of the building being leased to Selfridges.

HIS CONSCIENCE HURT HIM

Edward D. Ryan, traffic manager of the Milburn Wagon Co., of Toledo, and president of the Toledo Transportation Co., spoke before the traffic association of the chamber of commerce of Columbus, O.

Mr. Ryan reviewed the relation of shippers and railroad companies. He took a fling at the parcel post system. He said his conscience hurt him every time he sent an item by that system, because he felt that he was helping to cheat the railroads out of \$12,000,000 a year.

OF COURSE!

The Horse World has been looking about and it reports carriage builders saying business is excellent; prospects for the coming year better than ever, and the automobile does not seem to be curtailing the demand for buggies and wagons. One firm says: "Already we can note a gradual change to the horse-drawn vehicle and are sure it will grow."

CONSIDER THE FEELINGS OF THE OTHER BUILDERS!

"The fact is, that despite the unprecedented production during March (28,712), the close of the month saw the factory still many thousands of cars behind the sales department. An idea of the demand for Fords may be obtained when it is stated that on a single day early in April the factory received orders for more than 12,000 cars."

BIG CLAIM

The Eastern Wheel Manufacturers' Association made the statement last year that between eight and ten million metal wheels now are being manufactured in the United States in the place of wheels which formerly were made of wood.

"Every farm implement is now equipped with metal wheels and they are beginning to be used on wagons, while the wire wheel is also rapidly making its appearance on automobiles."

STUDEBAKER REPORT

The report of the Studebaker Corporation for the year shows profits of \$2,767,458, a decrease of \$575,102 from the previous year, with a total income of \$2,850,923, which was a falling off of \$614,029. Following the payment of interest, charges, etc., there remained a balance of \$871,399, a decrease of \$511,021. The profit and loss surplus was \$2,099,926.

FILE BANKRUPTCY PETITION

A voluntary bankruptcy petition was filed in the federal court April 3 by the Grinnell Vehicle Co., of Grinnell, Ia. The concern has liabilities of \$36,615.73, while its assets amount to only \$24,229.73. Charles Hodgdon, a part owner of the concern, filed an individual bankruptcy petition. He lists his liabilities at \$210; assets \$10. Miles Parish, partner of Mr. Hodgdon, petitioned the court several weeks ago to declare him bankrupt.

THE KARDO PATENTS

The eight patents now owned and controlled by the Kardo company present a formidable array of claims dealing with the gearset, driving mechanism and rear axle construction of the automobile. These claims are so closely interwoven that the combined ownership was absolutely necessary in order to prevent a long series of involved patent litigation on the part of the big companies using them.

FRENCH ARMY FAVORS FOUR-WHEEL DRIVE FOR TRACTORS

Four wheel drive tractors are considered by the French military authorities to be the most suitable type of vehicle for hauling heavy guns and ammunition wagons over ordinary roads and across country. This is an entirely new development of the power vehicle and one likely to have wide reaching effects.

GOODYEAR RE-ELECTS OFFICERS AND DIRECTORS

At the annual meeting of the stockholders of the B. F. Goodrich Co. all the directors and officers were re-elected for the coming year. W. O. Rutherford was elected as assistant sales manager.

A lecturer has said, in speaking of painting, that "we knew an awful lot too much and were fettered by what we thought we knew." This has a sane sound.

Trade News From Near and Far

BUSINESS CHANGES

T. J. Colligan has sold out his stock of vehicles, etc., in Thurston, Neb.

C. H. Unit has purchased the Lacy stock of vehicles, etc., in Harrison, Neb.

B. F. Meek has been succeeded in business at Maysville, Mo., by Leslie L. DeHart.

John Lenge has purchased the stock of vehicles of John Davis in Deer Creek, Minn.

Brom & Biesharr have succeeded to the business of A. M. Brom, in Fairfield, Ia.

Anton Anderson has purchased the Armour & Hovey business in Mondovi, Wis.

Geo. Stuart has purchased the stock of vehicles, etc., of Geo. Reitfors, in Alva, Neb.

Nick Vinckel has purchased the stock of vehicles of P. B. Neff, in Bloomfield, Neb.

B. F. Wise has purchased the stock of vehicles, etc., of C. G. Anderson, in Hardy, Ark.

J. E. Weber has been succeeded in business in Elgin, Okla., by R. W. Frick, of Apache.

M. A. Race has been succeeded in business in Stewartville, Minn., by Werner & Tuttle.

Wm. Roberts has purchased the W. W. Garberson stock of vehicles, etc., in Hartley, Ia.

W. D. Green has purchased the J. J. Lenhart stock of vehicles, etc., in Lockridge, Okla.

The Wm. Krotter Co. has purchased the business in Bonebrake, S. D., from J. H. May.

The Nation Co. has purchased the business of Patterson Bros., in Oklahoma City, Okla.

Lee Evans has been succeeded in business in Cleveland, N. D., by O'Donnell & Runner.

Alexander & Frank have purchased the J. O. Caves stock of vehicles, etc., in Westfield, Wis.

C. S. Musselman has sold out his stock of vehicles, etc., in Woodruff, Kas., by Burkey Bros.

The Low Auto Co. has succeeded to the business of the Pearson Auto Co., in Sac City, Ia.

Parsons & Crabtree have purchased the stock of vehicles of W. H. Campbell, in Goodrich, Kas.

Frank Brant has purchased the stock of vehicles, etc., from Bentley & Bierie, in Fairbanks, Ia.

A. R. Weaver, Batesville, Ark., sold his Pioneer Auto Co. to T. S. Craig and Glem Hisherson.

James Wilson has disposed of his stock of vehicles, etc., in Chester, Neb., to the Lasby Hardware Co.

Kraus Bros. have been succeeded in the vehicle and implement business in Eureka, Kas., by G. K. Jackson.

The A. M. Walling carriage factory at South Keyport, N. J., has been sold by Mrs. J. W. Herbert to D. E. Mahoney for \$2,200.

The La Porte (Ind.) Carriage Co., a catalogue concern, is in the hands of a receiver. Liabilities given at over \$129,000, assets under \$30,000.

NEW FIRMS AND INCORPORATIONS

The Coral Auto Co. has engaged in business in Coral, Mich.
J. H. Seedorf & Son are about to engage in business in Wells, Minn.

Craig & Stafrin are about to put in a line of vehicles in Utica, Neb.

R. J. Schierbrock opened an implement and vehicle business in Neola, Ia.

R. L. Stiff & Co. have opened a new stock of vehicles, etc., in Asher, Okla.

T. M. Euler has established himself in the vehicle business in Durand, Mich.

W. W. Bernard, Mitchell, S. D., has opened an implement and vehicle business.

Byron Barringer has opened a new stock of vehicles, etc., in Clay Center, Kas.

Asa Houghton is about to put in a new stock of vehicles, etc., in Hamilton, Mo.

E. Rodman has established an implement and vehicle business at Tamora, N. C.

B. P. Terry has engaged in the vehicle and implement business in Balaton, Minn.

Wm. Renwick has engaged in the vehicle and implement business in Billings, Mont.

H. J. Norris & Co. have opened a stock of vehicles and implements in Kinsley, Kas.

P. M. & M. S. Anderson are opening a new stock of vehicles and implements in Filley, Neb.

Iruscott Pierce Engine Co., St. Joseph, Mo., has been incorporated with a capital of \$40,000.

Adolph Peterson has opened a new stock of buggies, hardware, etc., in Oconto Falls, Wis.

Hill & Taylor, of Alexandria, S. D., have opened a new stock of vehicles, etc., in Fulton, S. D.

Pullmore Motor Truck Co., Detroit, Mich., has been incorporated with a capital of \$250,000.

Standard Wagon & Truck Mfg. Co., Detroit, Mich., has been incorporated with a capital of \$1,000.

A. C. Smith is engaging in the vehicle and implement business in a new store in Endicott, Wash.

J. M. Bachmann has established himself in the vehicle and implement business in Halstead, Kas.

H. M. Wight & Co. have incorporated in Sweetwater, Tex., and will handle vehicles and implements.

The Ahrenbeck Vehicle Co. has been incorporated in Navasota, Tex., with a capital stock of \$20,000.

J. C. Kimpel, of Gaylord, Minn., is engaging in the vehicle and implement business in Hingham, Mont.

Independent Motors Co., Port Huron, Mich., manufacturing motor trucks, has been incorporated for \$60,000.

Lahr Motor Sales Co., Bismarck, N. D., has been incorporated for \$100,000 by W. E. Lahr, G. H. Lahr, V. Lahr.

The G. A. Ten Broeck Co. has been incorporated at New Haven, Conn., to deal in wagons, trucks and autos.

Scurry Bros. & Co. have incorporated at Georgetown, S. C., to retail buggies, wagons and agricultural implements.

Jeffrey Motor Car Co., St. Louis, Mo., has been incorporated for \$4,000 by Albert Albrecht, Thomas Murphy, Geo. Eigel.

Wagner Wood Auto Co., Waterloo, Ia., has been incorporated for \$10,000 by Wm. Wagner, Wm. R. Wood and M. Wagner.

The Fruth-Peter Hardware Co., which has been incorporated in Fostoria, O., with a capital of \$15,000, will handle vehicles.

J. E. Anderson Motor Co., Jamestown, N. D., has been incorporated for \$50,000 by J. E. Anderson, A. Wells, J. H. Canham.

T. C. Martin, of Pullman, Wash., is about to open a branch house in Uniontown, Wash., and H. A. Miller will be in charge.

S. M. Talbot, Jr., of Plymouth, Ill., has leased a building adjoining his store and will there install his vehicle department.

Auto Utilities Co., Indianapolis, Ind., has been incorporated for \$10,000 by A. R. Robinson, F. A. Symmes and R. I. Marsh.

Saxon Kansas City Motor Co., Kansas City, Mo., has been incorporated for \$3,000 by L. F. Shelton, C. A. Forster and H. B. Smith.

Hudson Beace Motor Co., Kansas City, Mo., incorporated with a capital of \$20,000 by W. J. Brace, G. W. Jones and Z. T. Briggs.

H. Paul Prigg Co., Anderson, Ind., to manufacture cyclecars, has been incorporated for \$100,000 by H. Paul Prigg, S. M. Prigg and F. S. Sheets.

Motor Corporation, Indianapolis, Ind., motor accessories, has been incorporated for \$10,000 by W. L. Bedford, R. E. Weaver and K. R. Templeton.

The Franklin Hardware & Implement Co., which has been incorporated in Franklin, Ind., with a capital of \$20,000, will carry a large line of wagons and buggies.

The Galion (O.) Dynamic Motor Truck Co., manufacturing and dealing in motor trucks, has been incorporated for \$250,000 by J. B. Holmes, G. W. Nickels, N. G. Knight, C. H. Schaefer and J. J. Bittner.

The Hercules Truck Mfg. Co. has been incorporated at Wilmington, Del., to manufacture and sell the Hercules truck. Capital, \$100,000. The incorporators are F. L. Mettler, A. T. Crossgrove, A. Whartenby, Wilmington.

IMPROVEMENTS AND EXTENSIONS

Parrish & McDonough, of Osceola, Ia., are about to build an addition.

A. Young is about to move into his new wagon factory in Stilwell, Okla.

Leslie Motor Car Co., St. Joseph, Mo., has increased its capital from \$2,000 to \$5,000.

The Motor Supply & Tire Co., Cleveland, O., has increased its capital from \$1,000 to \$50,000.

Sachs & Rynda, of New Sprague, Minn., have begun the erection of a carriage warehouse.

B. A. Hudson & Co. have let the contract for the erection of a buggy factory in Kingston, N. C.

The Ft. Worth (Tex.) wagon factory has been purchased for \$60,200. The factory will be altered and enlarged.

Kilen-Walsh Mfg. Co., Appleton, Wis., reorganized with increased capital, now \$200,000. Make tractors and trucks.

Staebler & Fagan, carriage and wagon manufacturers at Peoria, Ill., will erect a two-story factory building to cost \$10,000.

The R. L. Tuck Co., of Main street, North Tonawanda, N. Y., will build a new wagon factory. The work will be started at once.

Luther M. Wright, of South Norwalk, Conn., is planning to erect a large addition to his present carriage works. The addition will be 40 x 75 feet and of two or three stories. Increasing business is said to be Mr. Wright's reason for this action.

P. L. Leemhuis, proprietor of the Keystone Carriage Works at Erie, Pa., is having plans prepared for a three story brick and tile building, 70 x 100 feet. Increased business made a new building with larger floor space necessary, said Mr. Leemhuis.

FIRES

Delker Bros. Buggy Co., Henderson, Ky., damaged by fire; loss, \$5,000.

Park Carriage Co., Henderson, Ky., burned out. Loss, \$50,000; fully insured.

The Lenhart Wagon Co., of Minneapolis, Minn., has suffered a fire loss of \$4,500.

The John C. Rennie Carriage Works, at Wheeling, W. Va., were damaged by fire March 20.

The buggy and saddlery stock of John T. Hanway, at Bryan, Tex., was damaged by fire on March 18.

The very large fire at Durham, N. C., also cleaned up the harness shop of B. C. Woodall for \$2,000.

The Priebe-Mathews Carriage Co. plant in Des Moines, Ia., has been damaged by fire to the extent of \$30,000.

The warehouse of the Jonesboro (Ark.) Spoke Co., owned by Clem and Fritz Holthouse, was destroyed by fire March 19.

Part of the plant of the Hess Carriage Co., at Hagerstown, Md., was burned March 26. A quantity of wagon wheels and machinery was destroyed. The loss is covered by insurance.

The Park Carriage Co., Henderson, Ky., owned and operated by John J. Delker, was burned March 18 with its contents. The loss is estimated at \$50,000, and is fully covered by insurance. Delker Bros.' Buggy Co. plant, adjoining, was damaged to the amount of \$5,000. It is reported that the Park Carriage Co. plant will be rebuilt at Evansville, Ind.

FIXING UP COLUMBUS BUGGY

The proposition for purchase of the Columbus (O.) Buggy Co. at 25 cents on the dollar, offered by the interests headed by Frank L. Chase, has been withdrawn. It is understood that this proposal would have given the creditors considerably over \$100,000 for the property. The only other offers for the business are somewhat indefinite, but would not pay more than \$100,000. It is the opinion of the men in charge of the property for the creditors that assets of the company are worth very much more than has been offered. Recently, it is understood, a letter was sent to the creditors asking if they would prefer to sell for 25 cents on the dollar cash or 50 cents in notes secured by first mortgage. Many of the creditors are said to have replied that they would prefer the cash. A meeting of the creditors is to be held here this week, when it is expected something definite relating to the future of the company may develop. Efforts made by the chamber of commerce to interest outside manufacturers or capitalists in the plant have failed to bring results. The effort of this organization was directed toward saving the industry for Columbus. It was found impossible, however, to bring those interested and the representatives of the creditors to anything approaching agreement on terms. The men in charge of the business at present are said to have some undeveloped plans which they hope will prove a solution of the problem and place the property on a paying operating basis.

LATER AND LATEST—COLUMBUS BUGGY CREDITORS GET 44%

Under an order issued by Federal Judge Sater, at Columbus, O., April 18, a dividend of 44 per cent. is to be paid the creditors of the Columbus Buggy Co. Under the order, \$273,960 will be distributed among creditors, and represents claims aggregating \$624,000. In the order of the court was an allowance of \$8,000 to Daniel McLarren, receiver, and \$8,000 to John E. Rodd and A. T. Seymour, who represented the receiver. An allowance of \$13,000 was also made to E. L. Pease.

ODDS OF 5 TO 1

Fifty per cent. of the orders taken by the White Hickory Wagon Mfg. Co. since January 1 are for early spring delivery compared to 10 per cent. in previous years.

A reflection of good general conditions through the south is the cause to which the company attributes this situation.

Heretofore, at least for the last several years, the great bulk of the deliveries have been during July and August.

Sales are reported active not only on farm wagons but also on city drays, the auto truck as yet showing no appreciable effect.

OBITUARY

Ira Marshall Appley, 28, manager of the Masquere Carriage Co., at New Orleans, La., died March 7.

George Beardsley, 80, formerly widely known as a carriage manufacturer and who was in business in New York City before his retirement 15 years ago, died March 19 of pneumonia at his home in New Rochelle.

Charles F. Betz, a Philadelphia wagon builder, died Sunday, March 15. The funeral was attended by a delegation from the Philadelphia Carriage and Wagon Builders' Association, of which the deceased had long been an active member.

Henry J. Bruhn, Sr., 71, pioneer carriage maker of Cleveland, O., died April 1. Death was due to old age and came after an illness extending over a year. Mr. Bruhn moved to Cleveland from Germany 52 years ago and engaged in the carriage business. At the time of his death he was proprietor of the Bruhn Auto Paint Shop, 1711 E. 17th street. Six daughters and one son, Henry J. Bruhn, survive him.

Thomas Callister, 87, one of the best known carriage dealers of Long Island, died at his home in Jericho turnpike. He was born on the Isle of Man, England, and came to America in 1848. Five years later he bought a small wagon repair shop in Queens and gradually developed the business until it had reached large proportions. He was later joined in business by his brothers, John and William, of whom the latter survives.

Joseph T. Cunningham, for many years a member of the firm of James Cunningham's Sons, carriage manufacturers, Rochester, N. Y., died March 30. Mr. Cunningham was born in Rochester in 1842 and entered his father's business about 1870. He occupied the position of president for a number of years, and also that of director. About four years ago he retired from active business life, but still remained a stockholder in the firm. Surviving Mr. Cunningham are his wife and two sons, Augustine and Francis J. Cunningham, and two sisters.

Jacob J. Deal, 87, founder of the Deal Buggy Co., Jonesville, Mich., died March 14. Mr. Deal located in Jonesville a poor boy, learned the blacksmith trade and worked at it for years, later going into carriage making, which was successful, and rapidly grew to large proportions. He had always been active in the management of his plant, although his son, the late George V. Deal, took over a large part of it.

John H. Fielder, 62, of Fair Haven, N. J., died April 1 of pleuro-pneumonia after a week's illness. For 40 years he was in the carriage making, painting and wheelwright business at Fair Haven. Mr. Fielder was born at Marlboro and went to Fair Haven when he was 22 years old. He started in the carriage making business, and also did wheelwright work and painting. He is survived by two sons and a daughter.

Philip Hammes, 79, a veteran wagon maker of Utica, N. Y., died March 15. Death was caused by a general breaking down due to the advance of age. Mr. Hammes was born in Germany, and came to this country when 17 years old. At the time of his death he was engaged in business with his sons, doing a general manufacturing and repair business.

H. W. Jones, 89, in the carriage manufacturing business in Ottawa, Ill., from 1858 to 1892, died March 21.

Daniel Kendig, who conducted a wagon business in San Francisco for many years and up to the time of the earthquake, died in Dayton, O., on March 4, following an accident in which he was struck by an electric car. His remains were taken to Oakland, Cal., for burial.

Peter Koell, 71, for many years in the wagon making business at Pittsburgh, Pa., died March 13 in that city. He came to this country from Germany in 1865.

Thomas A. Lee, 85, a retired carriage builder, died at his home in Rahway, N. J., April 15. He retired 19 years ago.

Dougald C. McIntyre, 76, died at his home in Tonawanda, N. Y., on March 29. He was born in St. Catharines, Ont. In 1878 he established a large carriage manufacturing plant in Sweeney street. He is survived by his wife, three sons and two daughters.

Hon. H. G. Newton, a director of C. Cowles & Co., New Haven, Conn., and for some time chairman of the executive committee of the same company, died suddenly March 23. Mr. Newton was well known throughout Connecticut and other New England states.

Frederick M. Porret, 71, formerly a wagon manufacturer of Jersey City, N. J., but in recent years connected with the United States Express Co., died April 4 of a complication of diseases. He is survived by his wife and five children.

Edward Roff, 76, retired carriage builder of Flushing, N. Y., died April 19, in the Flushing hospital.

Israel P. H. Wilmerton, 74, secretary and treasurer of the Kessler Wagon Works, Girard and Aramingo avenues, Philadelphia, died March 21. He is survived by his widow and two daughters.

William L. Yule, 51, vice-president of the Bain Wagon Works, at Kenosha, Wis., died March 17, at his winter home in Los Angeles, Cal. He had been an invalid for the past two years. His remains were taken to Kenosha for interment.

CLARENCE HEATH

Mr. Heath passed away April 5 after an illness that confined him to his house since the first of the year. Heart failure was the immediate cause of death.

As president and manager of the Shortsville (N. Y.) Wheel Co., Mr. Heath was widely known. His business life was passed practically in the state of New York, as he was born in Batavia, March 30, 1857, went to Shortsville in 1874, where he resided continuously, and was connected with the wheel company during the term of his residence.

H. PERCY JONES

The funeral services of H. Percy Jones were held at the home of his father in Newark, N. J., on April 23. It was very largely attended by personal and trade friends of both the deceased and of his father.

Mr. Jones, we believe, had not been in good health for some time, and went to California as a means of relief. He breathed his last in that land of sunshine, at Los Angeles, April 11.

Mr. Jones was the secretary of Phineas Jones & Co., and was an able assistant to his father, Mr. Henry Jones. He represented the third generation in the famous wheel factory business that has built its success and prestige on Jones business skill, honor and good faith.

We tender our sincere sympathy to the family.

SURE ! WE KNOW THEM

The largest manufacturing industry in Tullahoma, and one of the largest of its kind in the entire south, is that of the Campbell & Dann Mfg. Co., manufacturers of carriage and wagon wood stock, poles, shafts, rims, bows, etc. This concern gives steady employment to about 150 men, and has been in the business in Tullahoma for the past 16 years.

The capacity of this plant is something like \$200,000 worth of products per year, about ten per cent. of which is exported.

The vice-president, Mr. Ransom, was identified with Mr. Campbell for 20 years in the hub and spoke business, and came with this company when it was organized, bringing with him a wide experience and technical knowledge of timber.

Mr. Dann, the secretary and manager, came to Tennessee from Ohio in 1898, and organized the business as it is now constituted. Mr. Dann has been engaged in the manufacture of poles, shafts, and other vehicle woodstock for 30 years. His father before him was one of the first to manufacture goods of this class by machinery, having been active in this line since 1860, and having invented numerous pole and shaft-pending and finishing machines.

GERBER ON TOP

The suit brought by the Detroit Trust Co., trustee in bankruptcy for the Michigan Buggy Co., Kalamazoo, Mich., against E. F. Gerber and his associated companies, engaged in distributing automobiles, vehicles, sleighs, etc., products of the Michigan Buggy Co., enjoining Gerber and his companies from selling or disposing of any of their automobiles or other stocks, has been settled in favor of Gerber in the Federal Court. In the settlement, Gerber paid \$50,000 for all claims of all descriptions and in return had transferred to him accounts, automobile parts, automobiles and claims worth \$67,000. The Detroit Trust Co. claimed that Gerber owed \$404,000. Gerber denied that he owed any amount and that the Michigan Buggy Co. owed him. In the settlement made, Gerber's claims were fully substantiated, in that he received \$17,000 more than he paid.

Gerber and his various companies had for years taken from one-half to two-thirds of the output of the Michigan Buggy Co., selling their automobiles, vehicles, sleighs and blankets in 14 states. During the last several years, Gerber's business amounted to more than two-thirds of the Michigan company's entire production.

ENGINEERS' DATES FOR CAPE MAY MEETING

Cape May, N. J., having been formally chosen as the scene for the forthcoming annual summer meeting of the Society of Automobile Engineers, the dates have been definitely decided by the council of the organization.

The meeting is to be held in the new Cape May Hotel, and will be opened on Tuesday afternoon, June 23, with a meeting of the Standards Committee. Thereafter the activities will be continuous until Friday afternoon, though not all the time will be devoted to serious subjects. Wednesday morning, June 24, will be free with a business and professional session scheduled for 2 o'clock in the afternoon; the evening will be devoted to entertainment by the various sections of the society.

The second professional session is scheduled for 9:30 in the morning of Thursday, June 25, with another professional session at 2 o'clock in the afternoon of the same day; at 8 o'clock in the evening there will be a dinner and a lecture on the European trip proposed for the fall of the year. Friday morning, June 26, will be given over to a professional session and the meeting will adjourn, sine die, at about 1 o'clock.

BIG PLANT FOR EAST ST. LOUIS

The \$100,000 vehicle supply plant of the Townsend and Thompson Lumber Co., which will be located at Thirty-third street and the Southern tracks, East St. Louis, Ill., has begun construction. The Southern Railway switch has already been installed and several car loads of lumber are on the ground. J. W. Townsend and T. C. Willoughsby, officers of the concern, have moved their household furniture to East St. Louis and will superintend the construction of the plant. The plant will employ 100 men and will manufacture vehicle supplies, such as wagon tongues, single-tress and wagon spokes.

WANTS

Help and situation wanted advertisements, 1 cent a word; all other advertisements in this department, 5 cents a word; initials and figures count as words. Minimum price, 30 cents for each advertisement.

PATENTS

Patents—H. W. T. Jenner, patent attorney and mechanical expert, 606 F St., Washington, D. C. Established 1883. I make a free examination and report if a patent can be had and exactly what it will cost. Send for circular.

GOODYEAR TO DISTRIBUTE \$1,000,000

The stockholders of the Goodyear Tire and Rubber Co. recently met to authorize a distribution of \$1,000,000 or 20 per cent. in stock to the holders of its common shares. Dividends at the rate of 12 per cent. annually are paid on this stock which is valued at about \$225 a share. At the same meeting the stockholders unanimously approved the plan for the sale of \$2,000,000 in preferred and \$2,000,000 in common treasury stock. The stockholders have until March 14 to exercise these rights, and have subscribed to practically the whole offering.

PALMER GUILTY

Victor L. Palmer, who was secretary and treasurer of the Michigan Buggy Co., of Kalamazoo, now bankrupt, was convicted of fraudulent use of the mails, in United States district court in Grand Rapids.

He was found guilty upon 11 counts which charged him with sending a false statement of the financial condition of the buggy company to various banks in an attempt to obtain loans. The jury was out 55 minutes.

Palmer's attorneys were granted time to file a motion for a new trial. The penalty for the offense is not more than five years in prison or a fine of not more than \$1,000.

INDEX TO ADVERTISERS

Backstay Machine & Leather Co.....3d cover
 Baltimore Hub-Wheel and Mfg. Co..... 40
 Cargill Company, The..... 40
 Carter, Geo. R., Co., The..... 40
 Columbus Bolt Works.....4th cover
 Dowler, Chas. L..... 40
 Eccles, Richard, Co..... 2
 Fairfield Rubber Co..... 3
 Gerhab, Jacob 2
 Gifford, John A., & Son..... 2
 Jones & Co., Phineas.....3d cover
 Keystone Paint & Filler Co..... 3
 Lawson Co., F. H., The.....3d cover
 McKinnon Dash Co.....4th cover
 Masury, John W., & Son.....2d cover
 Meyer, John C., & Co..... 40
 Miller Bros. 40
 Mulholland Co., The..... 40
 National Spring & Wire Co.....4th cover
 Palm, Fechteler & Co..... 3
 Pierce, F. O., Co.....2d cover
 Porter, H. K..... 2
 Schlegel Mfg. Co., The..... 40
 Sheldon Axle Co..... 2
 Sherwin-Williams Co., The..... 1
 Skinner Bending Co., The J. M..... 40
 Smith, L. M., & Son..... 40
 Standard Oil Cloth Co..... 4
 Technical School for Carriage Draftsmen and Mechanics.. 40
 Virginia and North Carolina Wheel Co..... 1
 West Tire Setter Co.....3d cover
 White-Quehl Mfg. Co..... 40
 Wilcox Mfg. Co., D..... 1
 Willey Co., C. A.....4th cover

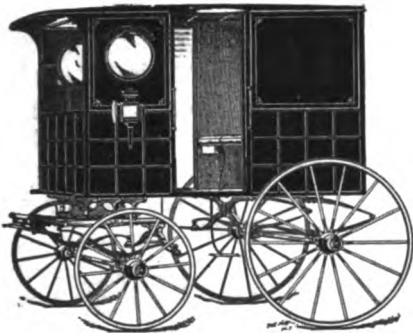

No. 112.—Milk Wagon.

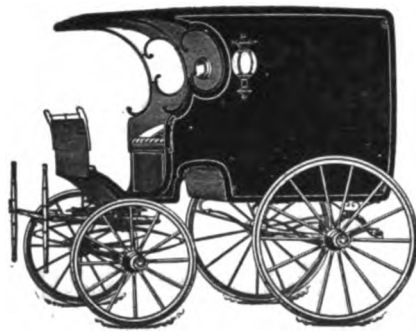

No. 111.—Altman Wagon.

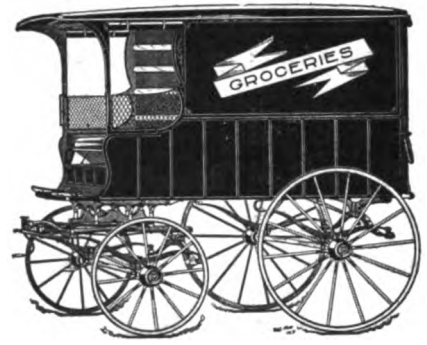

No. 113.—Grocery Wagon.

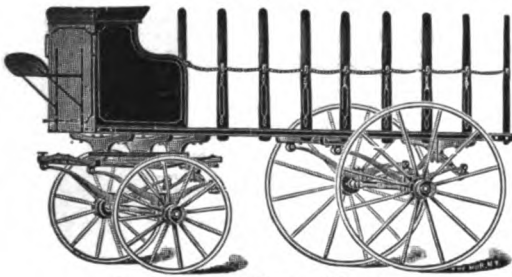

No. 122.—Flour Truck.

Electrotypes

of the vehicles presented on this page will be forwarded on receipt of

75 cts.

for each cut, to any address. Postage prepaid.

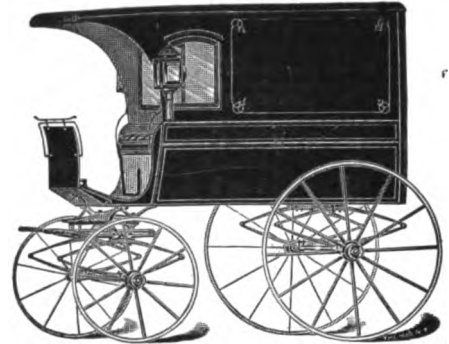

No. 115.—Delivery Wagon.



No. 116.—Milk Wagon.

Catalogue

containing nearly 200 illustrations of carriages, wagons, sleighs, and miscellaneous cuts will be sent upon application.

Trade News Publishing Co.
24-26 MURRAY ST.
NEW YORK

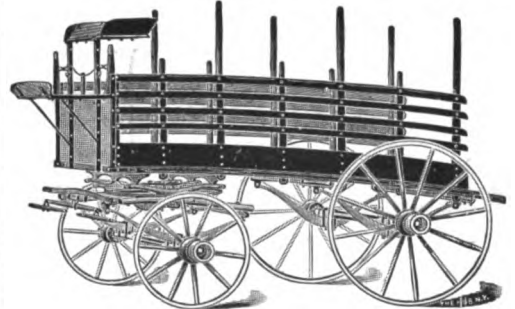

No. 117.—Merchandise Truck.



No. 114.—Delivery Wagon.

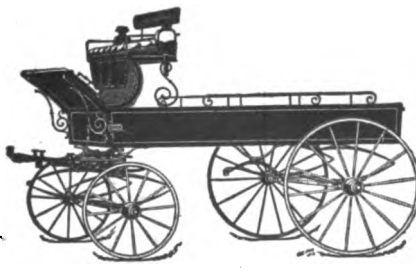

No. 124.—Delivery Wagon.

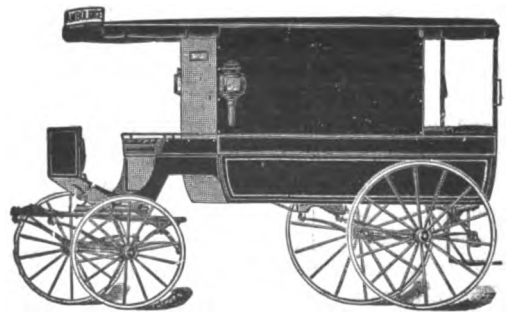

No. 118.—Ambulance.

BUSY BUYERS BRIEFS

If you want a good smooth strong thread, free from knots, and that will not break, send your orders to the John C. Meyer Thread Works, Lowell, Mass., and your girls and men will be happy.

Samples for the asking.

John C. Meyer Thread Works
Lowell, Mass.

Baltimore Hub-Wheel & Mfg. Company
Manufacturers of

Wheels AUTO MOTOR CAR CARRIAGE WAGON

Also SPOKES and RIMS

Factory: Harford Ave. and B. & O. R. R.
BALTIMORE MD.

L. M. SMITH & SON
LEATHER

Carriage, Furniture and Automobile
NEWARK, N. J.

59-71 Lock St. 234-236 Central Ave.
Office 59 Lock St.

MULHOLLAND BUGGY SPRING

Reduces weight of springs one-half.
Made in one size only but will fit bodies of all widths.

Write for further particulars and prices.
THE MULHOLLAND CO. DUNKIRK, N. Y.



LINED



UNLINED

White's Brazing Sleeves

For applying Rubber Tires
Send for Samples.

WHITE-QUEHL MFG. CO.

431 E. Pearl St.
CINCINNATI, OHIO

CHARLES L. DOWLER

CARRIAGE AND WAGON HARDWARE

108 North Third St., Philadelphia, Pa.

CUSHION MANUFACTURER

Pure Stearic Acid Candles. Wheel Stock. Snow
Flake Axle Grease.

The **GEO. R. CARTER CO.**

Manufacturers of

Automobile LEATHERS Leather Gimps, Welts, Leather Top Straps, Etc. Quarters and Stays, Shaft Leathers, Shaft Straps, Imitation Leather Gimps and Welts.

CONNERSVILLE, INDIANA

AUTOMOBILE Bodies AND CARRIAGES IN THE WHITE

Estimates Furnished on Special Designs

MILLER BROTHERS'

Amesbury, Mass.

The Schlegel Mfg. Co.

Rochester, N. Y.

Manufacturers of Coach Lace
and All Other Interior Trimmings

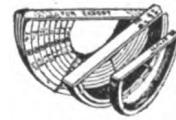

One of the oldest and largest Rim Plants in the world.

BENT RIMS

For Carriage and Wagon
Wheels

For Automobile Wheels

We make prompt deliveries in
HICKORY and OAK RIMS.

THE J. M. SKINNER BENDING CO.
Toledo, Ohio

Carriage Mechanics

Desiring to improve their present
Condition should attend the

TECHNICAL SCHOOL

FOR

Carriage Draftsmen and Mechanics

SUPPORTED BY THE

Carriage Builders' National Ass'n

The object of the School is to teach men to design vehicles and make working drawings, and to otherwise facilitate their work in the shop. Only those men employed in carriage or automobile building or their accessory trades are admitted to its privileges.

The classes are conducted in three divisions, viz.: Corresponding, Day, and Evening. The former is open during the entire year, while the day and evening classes are in session only from October 1 to April 1.

The tuition is moderate.

For prospectus and full particulars, write to the instructor,

ANDREW F. JOHNSON,

20 West Forty-fourth St.,
NEW YORK CITY

Cargill Service

has brought to the Cargill Company more Vehicle Catalogues than are made by any other printing house in America.

Cargill Quality is bringing The Best Automobile Catalogues to our plant for Complete production—watch for our imprint in the Season's best books.

THE CARGILL COMPANY

DESIGNERS
ENGRAVERS



PRINTERS
& BINDERS

Grand Rapids, Michigan



"Self-Propelled Vehicles"

Fifth Edition, Revised.

A practical treatise on the theory, construction, operation, care and management of all kinds of Automobiles.

By

JAMES E. HOMANS, A.M.

Contains 608 pages and upwards of 500 illustrations and diagrams, giving the essential details of construction and many important points on the successful operation of the various types of motor carriages driven by steam, gasoline and electricity.

This work is now the accepted standard, explaining the principles of construction and operation in a clear and helpful way. This book will be sent postpaid to any address in the United States, Mexico or Canada upon receipt of \$2.00.

Address

Trade News Publishing Co.

24 Murray Street, New York

Lawson's Sunken Panel, Twin Metal Buggy Seats

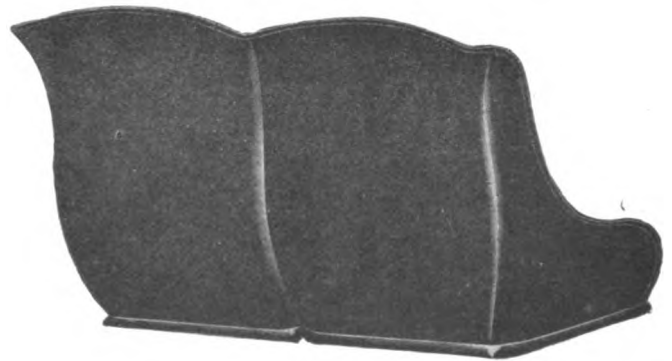

The Strongest—Neatest on the Market

Made in six sizes of 20 gauge automobile sheet metal. The Lawson seats are edged and bumped together by heavy presses.

We Use No Solder

Our seats were never known to come apart or rumble.

Write for Prices

The F. H. Lawson Co.

(Established 1816)

Cincinnati - - - Ohio

1855—Standard for 59 Years—1914

Jones Wheels

"Best on Earth"

The Name of Jones as Applied to Wheels Means the First, Last and All-the-Time Word in Wheels

"Kantsamore"

Buyers of vehicles should say, "Give me wheels made by

Phineas Jones & Co.

NEWARK

NEW JERSEY

U. S. A.

The WEST Hydraulic Tire Setter WILL CUT DOWN EXPENSE



Tires set cold in one minute. This machine saves time—does the work better and quicker, does a way with burned streaks. Only necessary to measure one wheel in a lot. Does not char the rim, and thus make the tire loosen prematurely.

Saves resandpapering of wheels. This machine is now increasing the profits of many manufacturers. Send for catalog and read about it.

WEST TIRE SETTER CO.,

ROCHESTER, NEW YORK



**LET'S
TALK ABOUT
WELTS, GIMPS
and BINDINGS**

AND A FEW OTHER
GOOD THINGS WE HAVE
SUCH AS SHAFT AND AUTO STRAPS
PROP BLOCKS (Wire Wrapped)
CUT LEATHER (All Grades)
RIGHT PRICES

**BACKSTAY MACHINE
AND LEATHER CO.**

UNION CITY
IND.

TROY, OHIO
CINCINNATI, OHIO

Your Vehicles will sell
against the
sharpest competition
if furnished with
**McKINNON
WING
DASHES**

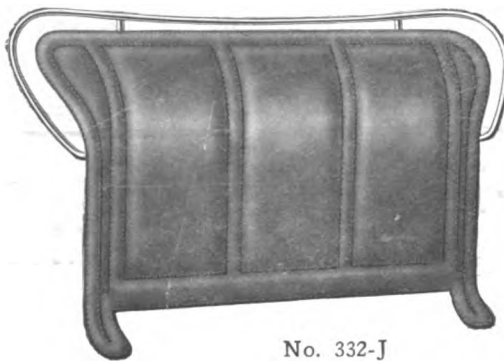

No. 332-J

ST. CATHARINES,
ONTARIO

**A
WING
DASH**
with Japanned Rail
that has a style and finish
to suit the
finest vehicle

McKINNON DASH CO. BUFFALO, N. Y.

"BLACK VELVET" CUSHION SPRINGS

Manufactured Only by the
NATIONAL SPRING AND WIRE COMPANY
ALBION, MICH. WINDSOR, ONT.

THE SPRING OF QUALITY.



SPRING or SOFT EDGE CUSHION FRAME
For Buggies or Other Vehicles. Built of the Highest
Grade of Steel Wire.

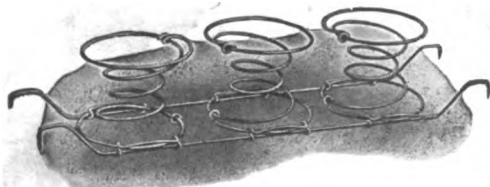

STRIP FOR WOOD OR BOX FRAME

WILLEY'S COLORS

The **RECOGNIZED STANDARD**



C. A. WILLEY CO.
COLOR GRINDERS

and Manufacturers of Specialties in

**CARRIAGE, AUTOMOBILE AND CAR
PAINTS**

COLORS, VARNISHES, ETC.

HUNTER'S POINT, NEW YORK CITY

Skewed Shaft Couplings

**Regular or Oval Patterns
For High Arched Axles**

Furnished in rights and lefts for any height of arch. Oval Axle
Clips $\frac{5}{8}$ or $\frac{3}{4}$ width to match Oval Couplings. Bolts, Clips,
Couplings, Carriage Hardware and Special Forgings

Catalogue "H" and Prices on Application

COLUMBUS BOLT WORKS, Columbus, O.

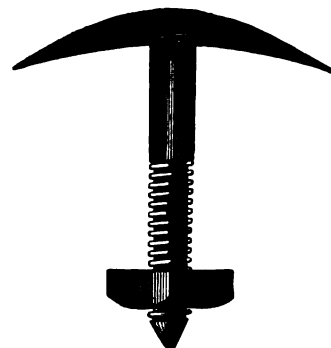
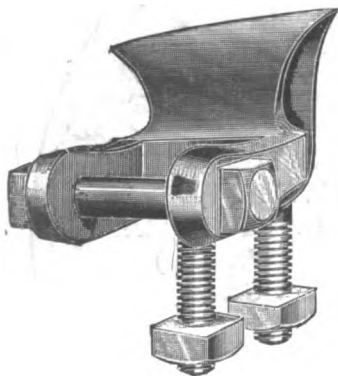

The Hub

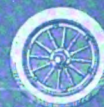

TRADE NEWS PUBLISHING COMPANY
24-26 MURRAY ST. NEW YORK.

JOHN W. MASURY & SON

Originators of

Superfine Coach and Automobile Colors

Acknowledged the Standard for Fifty Years

AND MANUFACTURERS OF

Fine Carriage and Automobile Varnishes

New York,

Chicago,

Minneapolis,

Kansas City

W. O. PIERCE CO.
NEW YORK,
U. S. A.

Manufacturers of High Class
Pigment Colors from ORIGINAL
FORMULAE. Colors ground in Japan
and other MEDIUMS to meet any
SYSTEM of APPLICATION.

AUTOMOBILE PAINTING

Our Automobile Color Book, showing latest shades for this class of work,
mailed upon application

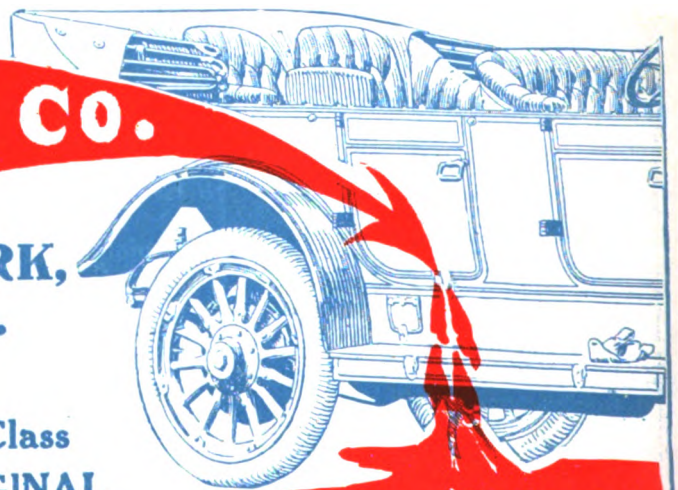

UZATONA
RED

SHERWIN-WILLIAMS
VEHICLE FINISHES

A PRODUCT FOR EVERY PURPOSE, PRODUCING DISTINCTIVE RESULTS

S-W METAL PRIMERS S-W BODY AND GEAR UNDERCOATINGS
S-W Q. D. COLORS S-W COLOR VARNISHES
S-W FINISHING VARNISHES

EFFICIENT IN QUALITY AND UNIFORMITY

The SHERWIN-WILLIAMS Co.

CLEVELAND CHICAGO NEWARK MONTREAL LONDON, ENG.

BENT RIMS Hickory Second Growth and Forest Hickory
All Grades
OAK—STAR BRAND

SPOKES Second Growth Hickory—Finished and Club Head
SUITABLE FOR ALL VEHICLES, INCLUDING AUTOMOBILES

VIRGINIA AND NORTH CAROLINA WHEEL CO.

8 Bridge Street, New York City RICHMOND, VIRGINIA

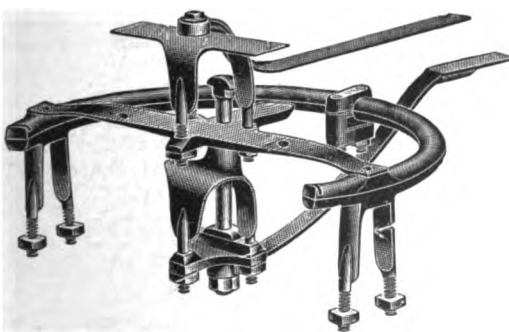

1902

W I L C O X

FINE FINISHED FORGED

Carriage Hardware and Gear Irons

WRITE US FOR CATALOG No. 11B

The D. Wilcox Mfg. Co.

MECHANICSBURG CUMB. CO., PA.

Please mention "The Hub" when you write.

SHELDON AXLES AND SPRINGS

For Horse-Drawn and Power-Propelled
Vehicles of All Kinds

JUST ENOUGH BETTER THAN OTHERS TO BE NOTICEABLE

When you specify "Sheldon" you are not experimenting with experiments, but are getting Axles and Springs with years of manufacturing experience back of them—Axles and Springs that are selected for important work where conditions make reliability supremely important

SHELDON AXLE COMPANY - WILKES-BARRE, PA.

LARGEST AXLE AND SPRING FACTORY IN THE WORLD

PORTER'S BOLT CLIPPERS

"Easy" "New Easy" Allen-Randall



To Cut 5-16, 3-8, 1-2, 5-8, 3-4 inch.

H. K. PORTER,

EVERETT, MASS.

Richard Eccles Co., Auburn, N.Y.

Manufacturers of

Forgings: Carriage, Wagon, Automobile' Special

Send for Catalogue No. 17.



DECALCOMANIE

TRANSFERS FOR ALL PURPOSES

We Carry the Largest and Best Assorted Line of Stock DECALCOMANIE in the World.
Special Designs of All Kinds, Name Plates, Seat Risers, etc., etc.

DECALCOMANIE ADVERTISING SIGNS OF ALL KINDS

No Shop Complete Without Our Catalog. Write for one.

PALM, FECHTELER & CO., 67 Fifth Ave., New York

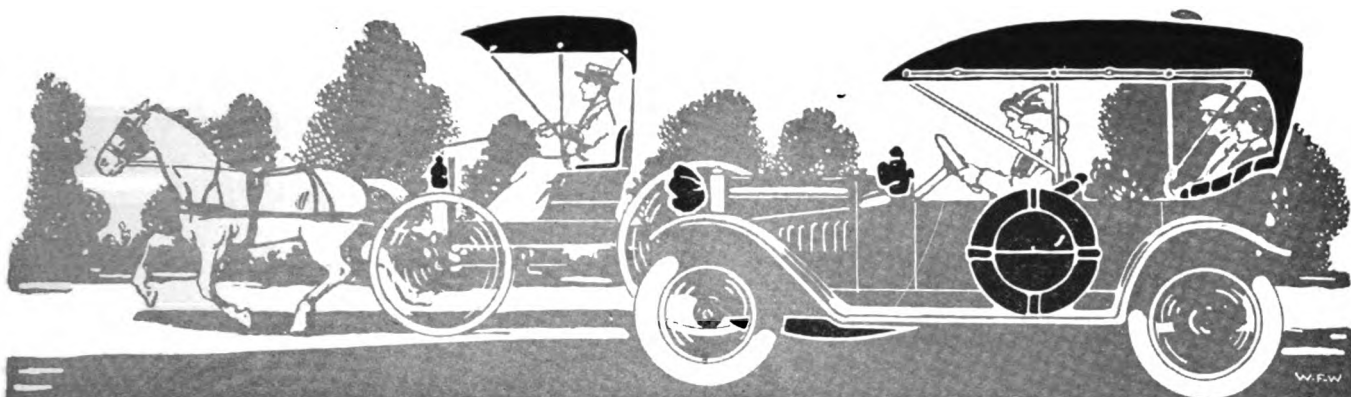

Learn More About The Leading Leather Substitute

Every carriage and automobile manufacturer—every manufacturer of carriage and auto accessories, storm curtains, aprons, lamp covers, tire cases, trunks, etc., should get and examine samples of

MERITAS

LEATHER CLOTH

Only by seeing the goods—by testing them—by noting the handsome, durable, non-cracking finish and the fine line of colors can you appreciate the high quality we have attained in the manufacture of a serviceable leather substitute.

There are styles, colors and finishes in MERITAS LEATHER CLOTH suitable for every carriage and auto trimming and upholstery purpose.

It can be had in muslin, duck and drill; dull or glazed; smooth or grained; in black and colors.

Sample book on request—write now and know more about the leading leather substitute.

Write
for
sample
book of
MERITAS
LEATHER CLOTH
NOW

Standard Oil Cloth Co.

320 Broadway, New York

Quality
Is
Economy

*Important Facts about
Murphy Body Varnish
for Motor Car and Carriage Bodies*

I Facts for the Builder:

It brushes with remarkable ease and smoothness.

It has a peculiarly fine flowing and spreading quality.

It enables the Finisher to increase his daily output.

It is hard enough for the assembly room over night—to hang in 16 hours.

II Facts for the Salesman:

It has an Elegance which greatly helps to sell.

People are fascinated by its perfect surface and by its *depth* of luster and brilliancy.

III Facts for the Owner:

It has the *lasting* beauty which multiplies pride and divides re-painting bills.

The Varnish
That Lasts
Longest

Murphy Varnish Company

FRANKLIN MURPHY, President

Associated with Dougall Varnish Company, Limited,
Montreal, Canada

NEWARK,
N. J.
CHICAGO,
ILL.

The Hub

Copyright, 1914, by the Trade News Publishing Co., of New York

Entered in the New York Post Office as Second-class Matter

Vol. LVI

MAY, 1914

No. 2

THE TRADE NEWS PUBLISHING CO. OF N. Y. Publishers of THE HUB

J. H. WRIGHT, *President* G. A. TANNER, *Secretary and Treasurer*
24-26 MURRAY STREET, NEW YORK

Other Publications of Trade News Publishing Co.:

HARNESS (monthly).....per year, \$1.00
AMERICAN HARNESS AND SADDLERY
DIRECTORY (annual).....per copy, \$5.00

THE HUB is published monthly in the interest of employers and workmen connected with the manufacture of Carriages, Wagons, Sleighs, Automobiles and the Accessory trades, and also in the interest of Dealers.

Subscription price for the United States, Mexico, Cuba, Porto Rico, Guam the Philippines, and the Hawaiian Islands, \$2.00, Canada, \$2.50, payable strictly in advance. Single copies, 25 cents. Remittances at risk of subscriber, unless by registered letter, or by draft, check, express or post-office order, payable to the order of THE TRADE NEWS PUBLISHING CO.

For advertising rates, apply to the Publishers. Advertisements must be acceptable in every respect. Copy for new advertisements must be received by the 25th of the preceding month, and requests to alter or discontinue advertisements must be received before the 12th day of the preceding month to insure attention in the following number. All communications must be accompanied by the full name and address of writer.

FOREIGN REPRESENTATIVES:

FRANCE—L. Dupont, publisher of *Le Guide des Carrossiers*, 78 Rue Boissiere, Paris. Subscription price, 15 francs, postpaid.

GERMANY—Gustave Miesen, Bohn a Rh. Subscription price, 12 marks, postpaid.

ENGLAND—Thomas Mattison, "Floriana," Hillside avenue, Bitterne Park, Southampton. Subscription price, 12 shillings, postpaid.

Entered in the New York Post Office as Second-class Matter

The Destructive Timber Forces

In this trade we have always been staunch supporters of everything and everybody that had the work of conservation of timber at heart because we fully appreciated what the timber supply meant to us.

Through association and individually we have promoted the conservation of timber while cutting it wastefully and using it uneconomically most of the time as a business matter.

We have had in the trade from time to time men who have really studied the timber problem, and who have supplied associates with a great amount of valuable information that was listened to with respectful attention, and endorsed with enthusiasm as a theoretical proposition, but the waste of timber continued as a steady business practice. We always find such anomalies where men are pursuing gainful enterprises.

There has always been a certain number who maintained that much of the talk about scant and decreasing hardwood timber supplies was academic. Yet all the time those who catered to the vehicle industry continued to move further and yet further away from the neigh-

borhoods that knew them well, in a search for supplies that were no longer generally plentiful and well distributed as in the beginning. We were characteristically wasteful.

Finally it was left to the government to undertake the job of conservation, and as there were no business axes to grind the work was begun well and has continued to better the beginning.

Striking facts regarding forest resources, their value and waste, have been recently condensed into an illustrated pamphlet by the American forestry association. We find therein that the lumber industry is said to employ 735,000 people that pull down nearly four hundred million in wages annually, and their labor produces a billion and a quarter of products each year.

At the present time, we are told, the forest area is more than five hundred million acres, but with the utmost care, a loss by fire of twenty-five million in money, cannot be yet prevented. But the insect damage, also, mounts into the remarkable total of fifty million dollars yearly. In view of this large total fire loss, it sounds somewhat incredible that the fire prevention patrol has reduced the fire losses to as low as one-tenth of a cent an acre.

The conclusions of those most qualified to speak are to the effect that by preservative methods a volume of timber estimated to be worth one hundred million can each year be saved. While these figures are inclusive of all varieties of timber, they naturally include the sorts we are interested in, and to that extent, gives us hope that those who maintained that there was and would be plenty of timber may be prophets in spite of the facts they faced before the government took a hand in the game.

The Interest in Retrospect

We are quoting at some length a view of the "cheap buggy" situation some twenty years ago. It is very interesting, even if it is not instructive to look backward and note how former conditions colored views of those engaged in the buggy building trade.

At the time under consideration there survived such an article as a "fine" buggy, and it was the yard-stick that measured the price of buggy value.

How the whirligig of time has mixed up, changed and confused these old-time views, we are well aware, and that is what makes the retrospect interesting now.

It is just as interesting as would have been the vision of a man of those times who prophesied the practical elimination of the "fine" buggy, the ascending and final

complete domination of the "cheap" grade, and the enormous development of the industry along the "cheap" lines.

In those halcyon times of the long ago (as we live twenty years is a cycle), there were fairly well-to-do men in the business, but the opulent merchants had to be sought for in other fields of business endeavors, while the "cheap" man who pinned his faith to appeasing the appetites of the millions for something on wheels, has been the one who has developed the big money class in the trade.

Now read the wise observations of the writer of the past times under consideration.

Will the concerns which have been responsible for the inauguration of the cheap vehicle craze, and the consequent failures during the past year, mend their ways, discontinue that destructive policy and sell vehicles at a fair profit? Or will they step into line as soon as possible and renew the contest for business with the same destructive tactics that have led to the recent demoralization. Manufacturers of pronounced conservative tendencies look with no small degree of apprehension on the renewal of the cheap vehicle craze, when profits are lost sight of in the fever of business. No one can answer this question. The trade singles out certain firms, and blames them for all the trouble. It is rather the system than the individual that must be blamed. Conservative men even now hesitate. They would escape this difficulty if they could. They would produce a higher class of vehicles if they could. But it is one thing to want to do and another thing to carry into effect. Trade channels are well defined. Shops are equipped for certain lines of work. Men of given skill and experience have been gathered around. Trade of a certain character has been built up. Customers have become accustomed to certain qualities and prices. They can afford and they want no other. Here, then, is our situation. The bulk of business is in medium priced vehicles. There competition is the sharpest. For one man who will pay ten or twenty dollars more for a little better job or fifty to one hundred for a superior job, there are nine who will do with the poorer and cheaper, because their means oblige them to do so. Why recapitulate all these influences? Necessity drives. The trade must simply adapt itself to those conditions and necessities.

There is no light out of the quagmire. Sharp competition is inevitable. Trade always has been a battle. Associations can make it nothing else. Agreements in whatever shape, looking to the curbing of competition, do not count for much. Trade is inexorable. To undersell a neighbor is its fundamental creed. To appear to give more for the same money is its claim and pretension. None can see the steps by which harmonious trade relations can be established, except on the basis of ability and endurance. Great concerns have certainly arisen out of the sale of cheap products. They have served the good purpose of reducing prices to consumers. They have made it possible for ten people to have a buggy, cart or wagon when before only three or four could afford them. For this wonderful achievement let the trade and the public thank these pioneers in cheap buggy and wagon construction. While many are condemning them, let us remember the wonderful progress and development they have made possible. They have blazed the way through the woods and underbrush. They have laid a foundation worth much to the trade. All disasters have their advantages, bring their blessings. The carriage industry would not be long what it is but for cheap vehicles. Some of the pioneers in this line have gone under crushed by the power they built up.

Must we and will we then return to higher priced vehicles? No. Must and will cheap vehicles sell for more money? Hardly.

What then! Will we re-enter the mazes of competition, and round up after awhile in another 1896? Not necessarily.

We are now speaking of deep underlying trade principles, of principles which act regardless of human control or supervision. There are forces at work which carriage builders, and for that matter, law builders cannot control. These forces never do harm. They may and do lead through individual disaster to aggregate good. It is this operation that is now going on, though we may not be able to pick out the evidences and proofs.

All these thoughts do not answer the one introductory question. Are we to have another deluge of cheap vehicle work? The shortest cut through this question, is to say we will have it. This answer should be qualified by saying, we will have this deluge in a somewhat different way. It probably will not be in the power of a few individual firms to play smash in the future. The advantages which the few have managed to secure to themselves, undermining, so to speak, so many others, will be enjoyed in a large degree by the others. In other words, cheap vehicles will be made by all, rather than the few. To state it differently, the few who have heretofore undersold, will be the less able, much less able to undersell their neighbors than they have been.

EFFECTIVENESS OF AMERICAN TRADE JOURNALS

Consul Geo. M. Hanson, Hobart, Tasmania, Australia, writes that the first few months at this consulate convinced me that the reason why more American goods were not sold here was because they were unknown. In a British colony it would be expected that the natural preference of the people would be for British-made goods, especially when a propaganda is being carried on for that purpose. But I did not believe this form of business patriotism would persist in favor of an inferior article or in face of a higher price. Therefore, in order to bring a wide assortment of American goods to the attention of business men and leading citizens generally, I decided to try the effects of advertising by means of American commercial journals and trade papers.

Letters were written to about two dozen publishers of trade and technical journals, asking them to put this consulate on the complimentary list for a year. The response was prompt and favorable and practically unanimous. When these papers began to arrive they were listed for appropriate distribution once a month. The chamber of commerce here has no regular meeting place, so I arranged to supply the reading tables of the three leading clubs with interesting literature, flanked by clever American advertisements. The motor boat magazines and Marine Engineering, with a sprinkling of other appropriate publications, were sent to the Royal Yacht Club. The Athenæum Club, composed largely of professional men and public officials, received a magazine on architecture, a technical journal on office fixtures, and an electrical publication. The Civic Club, composed of merchants, builders, contractors, etc., received the Building Age, a cement magazine, a hardware trade journal, an automobile journal, Dunn's Review, and other publications. Each of these clubs, besides, received copies of such weekly publications as the American Machinist, the American Architect, Motor Age, and Collier's. The sporting goods publications are distributed among the dealers in such goods. The result has been most salutary. Not only has a demand been created for American products but, by a widely diversified system of advertising, hundreds of American articles are kept before the public eye, an effect the value of which is well known to business men in the United States. It is generally admitted that American commercial publications have no equal; and American advertising has reached such a high state of perfection that it not only attracts but instructs its readers. I find that the advertising which has been "the life of the trade" in the United States can exert the same favorable influence in Tasmania and any other part of the world.

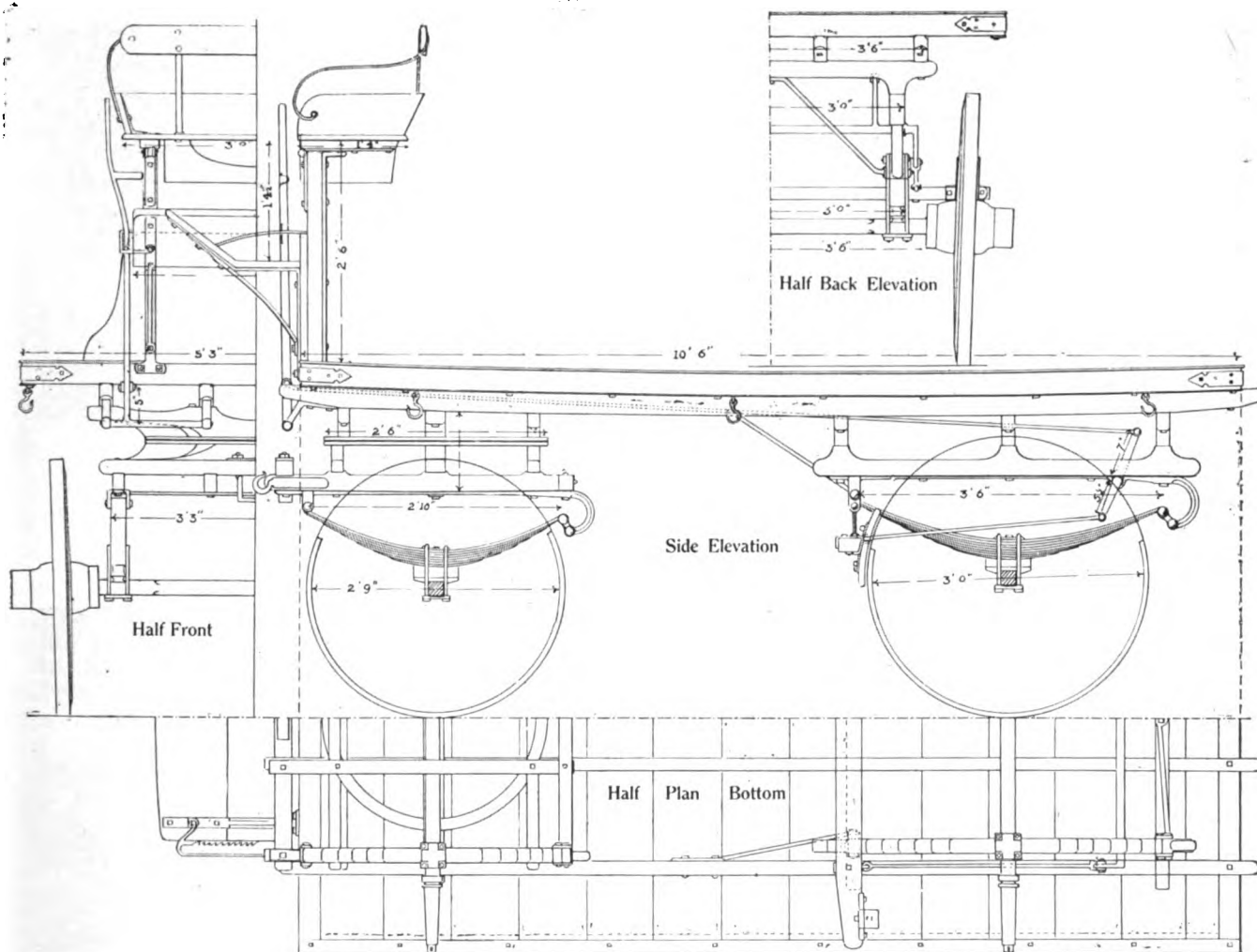

AN AUSTRALIAN (ADELAIDE) TRUCK
(From Australian Coachbuilder and Wheelwright)

Foreign Styles of

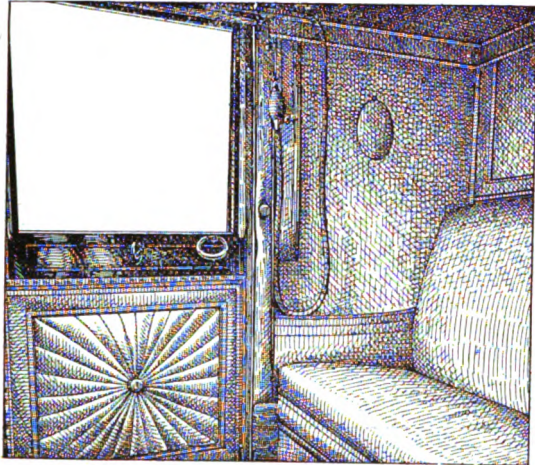

KELLNER BROS. (RENAULT)

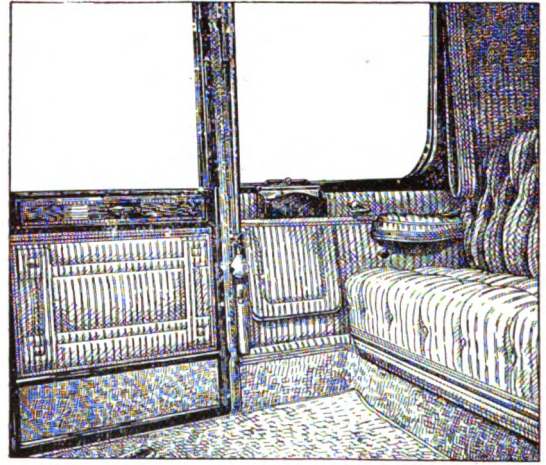

EUGENE BOULOGNE

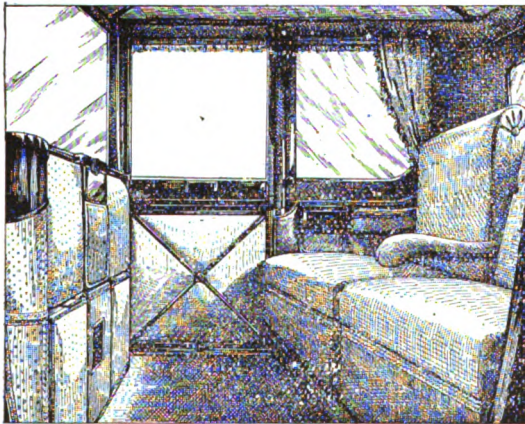

LAMPLUGH (PULLMAN)

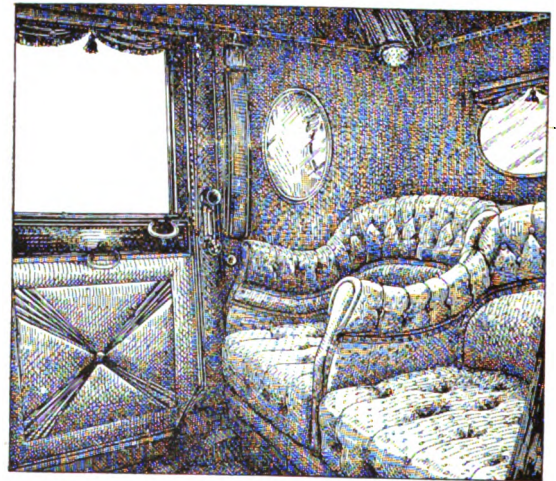

SAOUTCHIK

Limousine Trimming

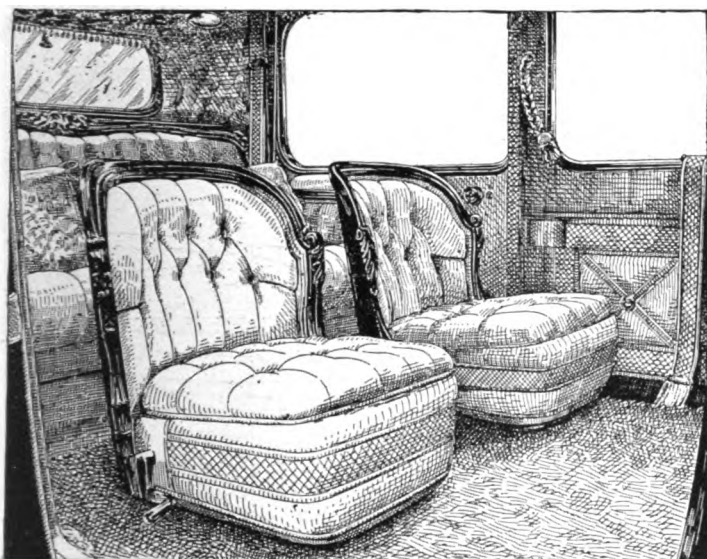

DAIMLER

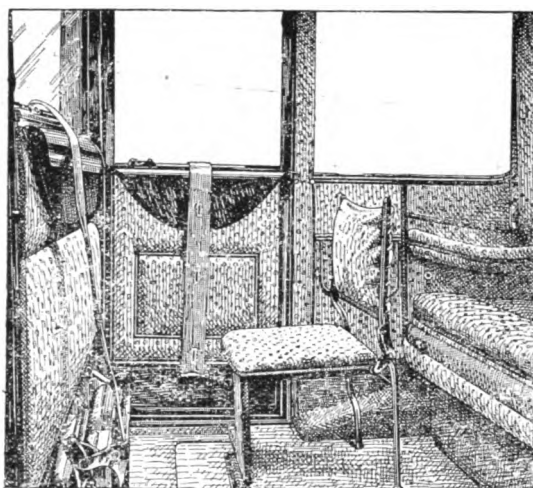

H. LABOURDETTE



FIAT

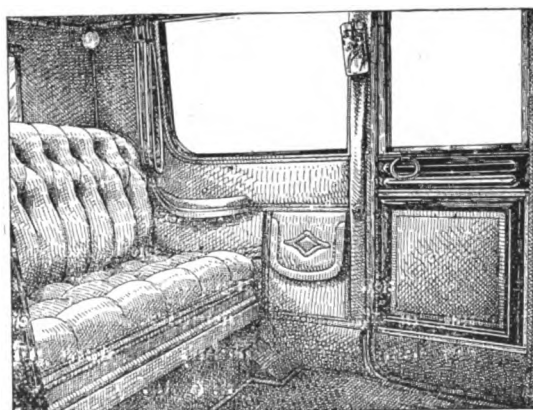

ARTHUR BOULOGNE

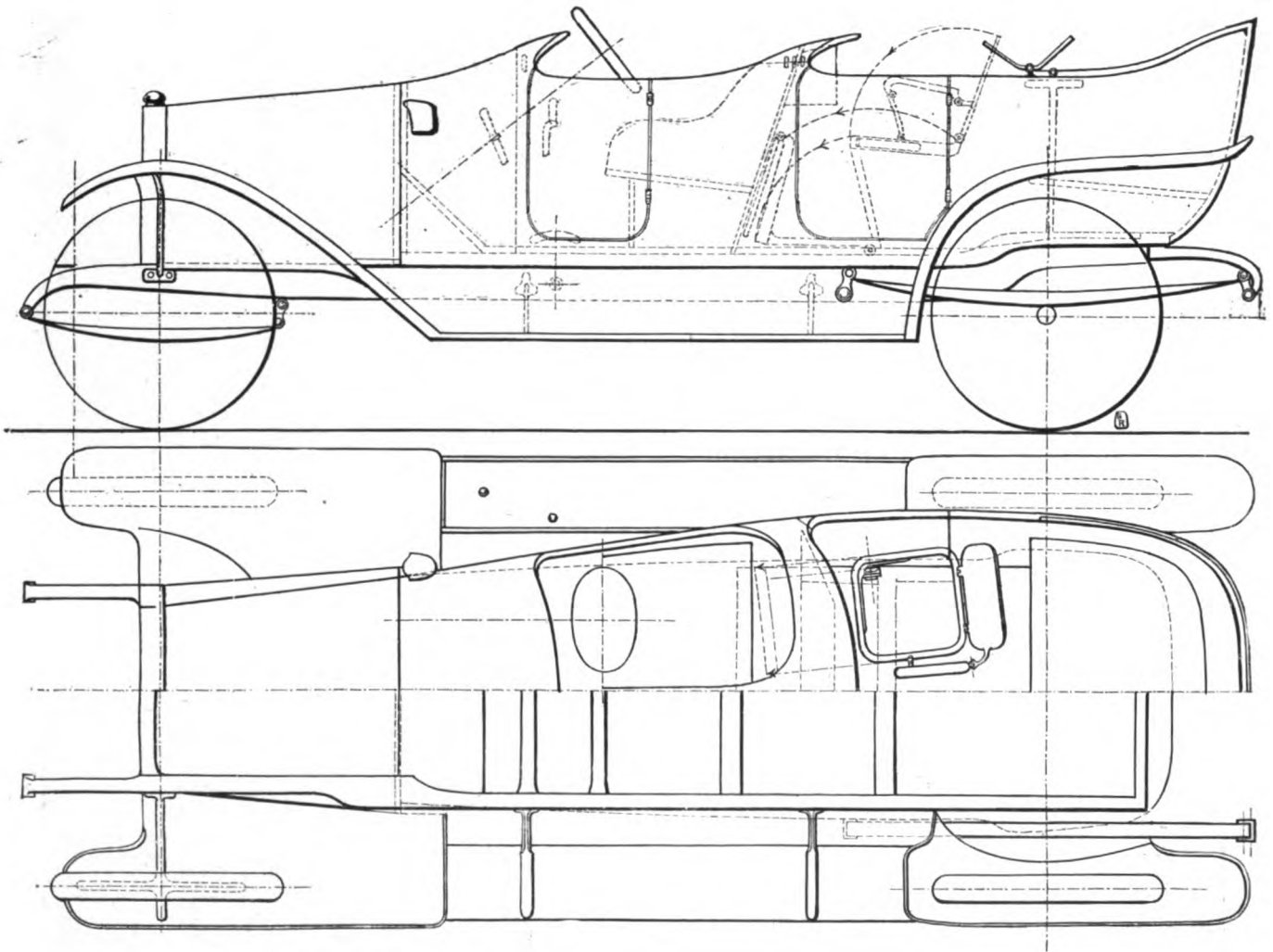

PLAN VIEW BENZ TOURING CAR
(From *Centraiblatt für Wagenbau*)

OFFICIAL NOTICE TO EXHIBITORS

**Carriage Builders' National Association, Atlantic City, N. J.,
September 28 to October 2, 1914**

The forty-second annual meeting of this association will be held in Atlantic City, N. J., during the week commencing September 27, 1914.

At the same time and place the annual exhibition of parts of vehicles, automobiles, models, new inventions, harness, horse equipment and materials pertaining to the carriage, wagon, automobile and accessory industries, will be held.

For the exhibition purposes the committee have secured Young's Million Dollar Pier, a well-lighted enclosure, which has been rebuilt, stronger and safer, making it one of the finest buildings for such purposes, and large enough to accommodate all who wish to exhibit.

The following rules and regulations have been adopted to govern the exhibit:

Exhibitors must be either active or associate members of the association.

The exhibits must be confined to models, parts of vehicles or automobiles, and to materials used in the construction of the same, or to coachmen's outfits, harness and horse furnishings. No finished vehicle will be admitted.

This exhibition is the members' own exhibition. They can take what space they may wish, from 8x8 feet to 20x100, or larger, if they desire, and as the exhibition is entirely for the benefit of the members, and as we never know their desire about the size of space they will need until the application is received, and also on account of the manner in which the space is sold—by mail only—it is impossible for us to make a diagram of the hall. For these reasons we cannot allow each one to choose his own location when making application for space. You can readily see, if we had a diagram sent out by mail, several might choose the same location, and by so doing, lead to endless confusion.

Therefore, no definite location can be allotted to any exhibitor on receipt of application. The space will be allotted in the order applications are received. Those making early applications to the secretary will secure what advantage in location there may be, and also avoid the delay in securing their space on the day of opening. As far as possible, ample room will be furnished to all.

The committee will arrange to have the exhibition space policed by day and watched by night, for the better protection of the exhibits, but cannot and does not assume the responsibility for loss or damage, from any cause, so far as individual exhibits are affected. The exhibitor must arrange and care for his exhibit, and he must assume all responsibility therefor.

Exhibits can be placed in position on Friday, September 25, and on Saturday, September 26, and the exhibits so placed must not be dismantled or removed from the exhibition hall nor shall any hammering or unnecessary noise be made in preparation for removal until 6 o'clock p. m., on Thursday, October 1.

And this rule is ordered strictly enforced.

All exhibits can be removed on Friday October 2, as the lease expires on this day.

In accordance with the agreement between the exhibitors and the president in Atlantic City in 1912, and so successfully carried out at St. Louis in 1913, the exhibitors will close their exhibits from 10:30 a. m. until 12 noon on Tuesday the 29th and Wednesday the 30th, so that the attendants and visitors may attend the business meetings.

With these exceptions the hall will be open from 8 o'clock a. m. until 6 o'clock p. m. each day from Monday the 28th, to Thursday, October 1, and on Friday, the 2d, until 6 o'clock p. m. of that day, when all exhibits must be removed from the building according to our arrangements. Our lease expires on that day.

As much of the hall as will be required will be marked off into 8, 12 and 20 feet wide sections, and aisles arranged about the reservations as liberally as the character of the floor space of the hall will permit.

The space will be sold according to the following scale of prices:

8 x 8 feet— 64 feet....	\$20	12 x 12 feet—144 feet....	\$45
8 x 12 feet— 96 feet....	30	12 x 16 feet—192 feet....	60
8 x 16 feet—128 feet....	40	12 x 20 feet—240 feet....	75
8 x 20 feet—160 feet....	50	12 x 25 feet—300 feet....	90
8 x 24 feet—192 feet....	60	12 x 30 feet—360 feet....	110
8 x 28 feet—224 feet....	70	12 x 35 feet—420 feet....	125
8 x 32 feet—256 feet....	80	20 x 20 feet—400 feet....	120
8 x 38 feet—304 feet....	90	20 x 25 feet—500 feet....	150
8 x 42 feet—336 feet....	100	20 x 30 feet—600 feet....	180
8 x 46 feet—368 feet....	110	20 x 35 feet—700 feet....	210
8 x 50 feet—400 feet....	120	20 x 40 feet—800 feet....	240

The charge for larger space will be in the same ratio.

Additional space to that already granted may also be arranged for, if exhibitors will forward application for such additional reservations one week before the date fixed and published for installation of exhibits.

Floor space only will be sold. This may be furnished by the exhibitor with desk, chairs, tables, railing, etc., to suit his needs. But the committee or its employes cannot undertake to furnish any of these articles, although a list of well recommended local dealers, carpenters and decorators may be had by application to the superintendent of exhibits, who will do all possible to facilitate the supplying of the needs of the exhibitors.

The space allotted to any exhibitor must not be sublet to anyone not members of the association. This rule is imperative.

No signs in the body of the hall shall be so displayed as to interfere with proper observance of community interest. It must be an implied agreement on the part of the exhibitors when reserving space, that the secretary, or the superintendent shall be the sole and final judge of infractions of this regulation, and his decision shall stand.

Any damage to the building by any of the exhibitors must be settled for before the exhibits are removed from the building.

The association assumes no responsibility whatever for care of exhibits, boxes, crates, etc., other than to furnish such assistance to exhibitors as will enable them the more quickly to install exhibits, and to remove the crates to a storage place where they are to remain as a matter of convenience to exhibitors, and at their risk, although the usual precautions, as stated elsewhere, will be taken to safeguard property as a whole.

Applications for space should be made to the secretary now, and should state the nature of the exhibits, as well as the space required. As far as it is possible, the space will be assigned in the numerical order of receipt of application. The sure and only method of securing the best locations is to make early application.

Payment for the space taken can be made with the application, or, if the exhibitor prefers, can be made on receipt of notice early in September. Receipts for same will be returned by the secretary, and said receipts will be received as voucher for space, when presented to the superintendent at the hall.

We would suggest that goods sent for the exhibition should, if possible, be sent express prepaid. If forwarded by freight, from distant points, experience has demonstrated that there is no surety that goods will arrive when wanted, unless they are shipped at least one week before the time the freight agent declares is ample time for shipment. The freight should be prepaid if prompt delivery to the hall is expected, after goods reach terminals.

Mark goods plainly, and in more than one place on the package or crate, as directed below, and be very careful to also mark on the package the name of shipper also. This precaution aids the committee in identifying goods in owner's absence,

aids quick installation on spaces ready for exhibitor, and prevents loss by reason of non-identification.

Mark as follows: "Carriage Builders' National Association Exhibition, Young's Million Dollar Pier, Atlantic City, N. J."

For bulky exhibits, too large to send by express, arrangements have been made with The Eldredge Express and Storage Warehouse Co., 110 N. South Carolina avenue, Atlantic City, to receive and transfer the articles intended for the exhibition, from the freight station to the exhibition. Should you desire them to take charge of your goods we would advise you to notify them when goods are sent, the route, and, if possible, send them duplicate bill of lading.

The executive committee requests all exhibitors to be sure that they quote prices only to vehicle manufacturers.

The president of the association will appoint a "special committee on exhibition," to examine the exhibits and make a report to the convention of such articles as show improvement in their special lines, or show a high order of inventive ability.

By resolution passed at the annual meeting held in New Haven, Conn., October 17, 1883, it is required that any firm or company wishing to exhibit goods at the convention, should have at least one of its partners or officers a member of the association; and the fact that a representative or employe is a member will not alone be sufficient.

Extracts from the Constitution Article III

Section I. The members of this association shall be persons engaged in manufacturing or selling vehicles for pleasure or freight.

Section II. Associate members may be elected from any trade or profession pertaining to the vehicle trade, upon payment of the dues, prescribed by the By-laws, which shall entitle them to all privileges of the association (including the annual dinner) excepting a vote on the election of officers.

Extract from the By-laws

"The annual dues shall be \$10, payable in advance."

Applications for membership should be addressed to Henry C. McLearn, Secretary, Mount Vernon, N. Y.

HENRY C. McLEARN, Secretary, Mount Vernon, N. Y.

By order of the Executive Committee of the Carriage Builders' National Association.

SPECIAL NOTICE TO EXHIBITORS

Here is the notice for the exhibition and the rules governing the same, to which we invite the attention of all our members who propose making an exhibit this year.

You will notice that the exhibits must not be dismantled or removed, nor any preparation for removal made, until 6 o'clock p. m., on Thursday, October 1.

All exhibits must be taken out on Friday, October 2, as the lease expires on that date.

We would suggest you notify your representatives to stay with your goods and see that they are properly delivered to the transfer company for shipment. No other person can do this nor tell if all have been shipped. This will prevent confusion. No one can tell to whom they belong, or where they are to go, nor can any one tell if they are properly cared for, unless the owners stay by them until they leave the hall. Please so instruct your agents.

The Eldredge Express and Storage Warehouse Co. have agreed to deliver all freight shipments from the tracks of the railroad companies to the exhibitor's booth on the pier, and at the close of the exhibition to return the goods to the railroads, at the following rates:

Consignments weighing over 300 lbs., round trip, per net ton	\$6.00
Consignments weighing over 300 lbs., one way, per net ton	3.00
Consignments weighing under 300 lbs., round trip.....	1.00
Consignments weighing under 300 lbs., one way.....	.50

Payment for delivery as above should be made direct to the Eldredge Express Co.

All shipments must be fully prepaid and notice of shipment should be sent to the Eldredge Express Co., 110 N. South Carolina avenue, Atlantic City, N. J.

Joseph L. Shoemaker & Co., 926 Arch street, Philadelphia, will furnish furniture at the following prices, they having a branch store in Atlantic City that attends to convention wants: 3-foot golden oak roll-top desks, @..... \$6.00 4-foot golden oak roll-top desks, @..... 7.00 4-foot golden oak flat-top desks, @..... 6.00 Golden oak revolving desk chairs, @..... 2.00 Golden oak arm chairs, @..... 2.00 Golden oak side chairs without arms, @..... 1.00 Golden oak 6-foot tables, @..... 5.00 Golden oak 5-foot tables, @..... 5.00 Golden oak 4-foot tables, @..... 2.50

The above prices include delivering and setting in space, and removing after the exhibition is over.

Where rugs are desired, domestic orienal design rugs will cost 15 cents per square foot, and imported oriental rugs 25 cents per square foot.

This information is for the exhibitors, the association having no pecuniary interest in it.

We invite your attention to the following:

Extracts from the minutes of the Executive Committee as published:

"In relation to the order made at the Chicago convention relative to soliciting orders on the exhibition floor, the executive committee desires to call all members' attention to this, as they think a moment's reflection on the part of those not having any exhibit, will convince them that it is unfair to those who have made the exhibition hall their office and salesroom for the time being, and paid for this opportunity to meet the vehicle trade, and that it is not right for any one not exhibiting to come on the floor and solicit trade that rightly belongs to those who have exhibits.

As any member can secure space at these exhibitions, if they desire to look for trade at same, they should take space and be on an equality with those who do.

"All members are welcome to visit the exhibition, but fairness to those who pay for the privilege of exhibiting should prevent all from making unfair use of this privilege."

The following resolution was passed at the convention at Chicago in 1908:

"Resolved, That the secretary of the C. B. N. A. be instructed by the association to adopt such regulations as to exclude from the exhibit hall all representatives of the accessory trade that are not members of the association.

"Resolved, That the exhibitors and their representatives be furnished with a badge showing they are exhibitors or representatives of the same."

In accordance with the above resolution, the executive committee, the Associate Members Association, and the secretary, as ordered(have arranged that the admission to the exhibition hall shall be by ticket, to be produced at the entrance door on registration.

This ticket will be provided free to all members of the association, both active and associate.

And also to all carriage, wagon, sleigh, automobile and motor car builders who are not members of the association.

But not to any manufacturer or dealer in the accessory goods who are not members of the association.

The exhibitors will be provided with badges for themselves and their attendants as the above resolutions call for, and these will be delivered to them on the first day the exhibition is open.

These resolutions will be carried out and enforced, and the secretary requests the co-operation of all the members in having this done.

We would also suggest that you instruct your representatives

to carefully obey the rules as printed, and we will send you as many copies as you may need to provide enough for this purpose.

By order of the executive committee.

HENRY C. McLEAR, Secretary.

NEW OFFICERS AND COMMITTEES

The recent Cincinnati Carriage Makers' Club election has resulted as follows:

President—Walter G. Brunsmann, Anchor Buggy Co.

First Vice-president—Clen Perrine, Brown Carriage Co.

Second Vice-president—Harry Roettinger, Western Spring & Axle Co.

Treasurer—B. L. Craig, Cincinnati Panel Co.

Secretary—A. S. Brown, Summit Thread Co.

The Committees are as follows:

Entertainment—Jos. Wallenstein, chairman; Charles Egolf, J. B. Childe, Fred Guckenberger, Harry Roettinger.

Press—A. S. Brown, chairman; Geo. Huston, W. H. Barcus, Matt Center, Howard Cox.

Freight and Classification—E. M. Galbraith, chairman; Theodore Luth, C. W. Shipley, W. A. Sayers, J. F. Taylor.

Legislative—Melville Ritchie, chairman; Harry McBride, E. J. Hess, P. P. Hunter, B. L. Craig.

Technical School—W. A. Sayers, chairman; H. M. Pollock, Henry Meyer, C. B. Vandervort, Frank Knoblauch.

Insurance—Clem Perrine, chairman; J. Schneider, Chas. Steele, Theodore Scheu, W. W. Sechler.

Good Roads—O. E. Walker, chairman; E. F. Alf, Albert Armstrong, W. H. Young, C. L. Stevens.

Labor—Otto Armleder, chairman; E. V. Overman, G. S. Brown, Chas. A. Fisher, H. H. Nelson.

THE TRUTH ABOUT MOTOR DEVELOPMENT

A writer recently said that he would like to see all cars fitted with a standard control, by which was meant that all the operations and movements for the control of the car, steering, gear changing, braking, throttling, etc., etc., should be the same on all cars. Now, I do not at all agree with him, and for several reasons, replies Mr. Sturme in *Motor*. First of all, because any such standardization would hamper development and hinder improvement. Secondly, because it is altogether too early in the history of the motor car to talk of standardization, except in regard to screw threads, nut and bolt sizes, and width of tread. Thirdly, because, upon many of the items of what may be termed the conventional control, where there are two or more ways of doing the same thing, motorists are by no means agreed as to which is the best way of doing it, and also by reason of the fact that the number of motorists to whom such standardization of control would be of real value is comparatively small.

To begin with, it will be admitted that the motor car has not yet reached perfection by any means, and I think it will also be admitted that the average motorist is not a mechanic or engineer, and although able to manage his car and look after it, either with or without the help of a chauffeur, he is really not able seriously and soundly to weigh up the merits of new inventions and developments, and depends very much upon the opinions of experts, would-be experts, and the technical press, and if all these combined in the adoption and approval of any one system of control, any departure from that standard, whatever its merits, would have an enormously difficult, nay, almost impossible task before it to secure recognition and attain commercial success, and the public would thereby be oftentimes deprived of the benefit of real improvement. Indeed, I hold that this is already the case today, for, although the details of control vary, the broad idea and general system, both of control and construction, have got into a conventional groove,

which makes the task of the seeker after improvement a very up-hill one indeed.

For example, I would ask what chance the control of the engine by sleeve valve or rotary valves would have had had it not been for the enterprise and pluck of the Daimler Co., when they took up the Knight engine? Had Mr. Knight endeavored to place his invention on the market himself, or had it been taken up by one of our smaller and lesser-known firms, instead of by one of our leading ones, do you think we should have had the sleeve valve and rotary valve engines we have today? The "experts" were, almost to a man, against it; the pseudo-experts and the press, for the most part, at first followed the others, and the public would have followed all three had not the Daimler Co. been powerful enough and important enough to secure recognition for it by reason of its own reputation for practicability, coupled with the merits of the invention itself.

Many a small firm with an equally good proposition has failed in the endeavor to break down conservative conventionality and the weight of the opposition. As it is, we are invariably too much inclined to follow the racing man and the speed expert, in the design of cars in the use of which speed will not be a required factor. The extremely low seats, which are uncomfortable for all-day driving—for instance, and the "submarine" type of body, both designed to reduce wind resistance at high speeds, are, to my way of thinking, as useless and unnecessary on cars which will never be asked to exceed 30 miles per hour, and may rarely equal that, as top hats would be on a cricket field, and we have also to remember that, for many years, the wire wheel was tabooed by the public and manufacturers alike, until S. F. Edge took it up and pushed it into prominence, and this in spite of the fact that it had, from the beginning, been a proved success on the Lanchester cars. But then, at that time the Lanchester Co. was a comparatively small concern, and, in the earlier years, not a very successful firm commercially; so that, in face of the opposition of the "experts" and of the rest of the trade—in other words because it was not a recognized "standard" equipment—what is now universally admitted to be a good thing had to take a back seat.

I remember seven or eight years ago, Mr. Lanchester telling me his firm often lost orders from people who would not buy a Lanchester car "because it had wire wheels," and it was just the same with me, 10 years ago, when I introduced throttle control. "Experts" were consulted, and orders which would otherwise have been given were turned down on the ground that "throttle control was uneconomical." These are but a few of the many instances which have occurred to show the strongly deterrent effect of conventionality, and of anything approaching an accepted standard, upon development and improvement; so that the reason for my opposition to the idea is apparent, and, as I have already said, it is yet too early in the history of the motor car to talk of it.

As to just which are the best methods of control today, experts themselves are not agreed, and the disciples of the different schools of thought all have arguments, not unreasonable, with which to support their contentions. Take the vexed question of throttle control, for example, which, as I have already said, the experts would not have at all a few years ago. While one section believes in keeping the engine normally throttled down and opening up as required by the use of an accelerator pedal, another would have us only use a pedal to decelerate from a position of open throttle, while a third does not believe in pedal control of the engine speed at all, and would have us confine the control to the hand lever on the wheel—or under the wheel, for we have variations of that as well—alone. And so it is with nearly every item which enters into the control of a car. To settle on any one of the variations which pertain, and say that that, and that alone, is the one to be employed, ignores the merits which may be possessed by the others, and as the temperament and idiosyncrasies of individuals, as well as their ideas of driving, differ widely a very large portion of

the motoring community would have, willy-nilly, to accept and put up with methods which, so far as their own particular requirements were concerned, could be substantially improved upon by already known methods. But we are still at the beginning of things, and, left to itself, or rather if designers and inventors are given a free hand, untrammelled by convention or any other artificial bonds, the motor car—which as those who know it best will be the most ready to admit is still far short of perfection—will differ more widely 10 years hence from the cars of today than does the present-day vehicle from its forerunners of a decade since.

The progress of invention has been rapid during the past few years, and I believe we are on the eve of greater discoveries and developments in motor car construction, as in almost everything else where the prospect of financial reward for the successful investigator is good. With the introduction of new principles in engine construction, in transmission and in other important constructional features, it will necessarily follow that the details of control, where these new principles are involved, will differ considerably from those we now know. Were we to adopt any one standard set of control details today, it would not be very long before some of them became obsolete where new principles were applied, and then, with the public educated to a belief in the employment of our standard series, the new and improved principles would be turned down by many to their own loss, because the cars to which they were applied would have different control details, or might even be without some of them altogether!

When we get the car, for instance, in which either infinitely variable or automatic gear is embodied—as get it we assuredly shall—"gate" change and even the change-speed lever itself will go, because they will no longer be required. Yet I can fancy the assertive pseudo-expert loudly declaiming against the new "Marvel" car, fitted with one or other of these innovations, as "no good" and roundly asserting that he "simply wouldn't have, Sir," a car without a gate change—for, of course, if any standard series of control details were adopted today, the gate change would be included in the selection. And I can also fancy the opinions so loudly expressed being passed on from one to another, and given all the greater weight by the fact that one of the sacred "standard" details—which, of course, being "standard" must be right—was being threatened.

A ROAD POLICY INTENDED TO SATISFY ALL

Highway authorities may reconcile the demands of automobilists and business men for permanent intercity highways and of farmers for improved tributary roads with the objection of taxpayers to increased road taxes by following these rules formulated by the Automobile Chamber of Commerce after a study of the opinions of prominent highway authorities:

Take a census of traffic to ascertain the number and kinds of vehicles using the state roads at different points.

Build brick, concrete or other durable roads wherever there is much heavy teaming, motor trucking and automobile driving.

Such roads should be built wherever the cost of properly maintaining any other kind would amount to more in 25 years than the cost of maintaining the durable roads plus its extra first cost and interest on the excess.

Issue 15-year to 25-year bonds to pay for permanent work if sufficient funds are not available. It is sound economic policy to raise money with bonds for all road work that will outlive the term of the bonds.

Pay out of current funds provided by general taxation and assessment the cost of surfacing with any material that is not as durable as brick or concrete.

Make gravel roads where traffic is comparatively light and there is not much automobile travel, first grading and draining the foundation thoroughly.

Extend the mileage of permanent highways with money saved by building gravel roads instead of macadam roads.

Confine construction as much as possible to durable roads and gravel roads so that the total cost will not exceed that of an equal mileage of macadam roads nor increase the state or county expenditure.

Use quartz, shells, burnt clay or a mixture of sand and clay where gravel is not readily obtainable. They are all good substitutes.

Grade and drain the earth roads and insist upon having them dragged in spring and fall. If necessary, get a drag law passed similar to those in Iowa and Ohio. Drag the gravel roads also in spring and fall and apply new gravel to ruts and depressions.

Concentrate the expenditure of state funds on the improvement and maintenance of intercity or trunk lines, because they carry about 80 per cent. of the total traffic.

Instead of depending for road funds upon uncertain appropriations by legislature, provide by law for an annual levy on all taxable property.

Work convicts on the roads and in the production of road materials, thereby cutting down the labor cost.

Have the state or county acquire or lease gravel and sand pits and install modern excavating, sifting and washing machinery to reduce the cost of materials.

Select the most suitable materials nearest the roads to be improved, remembering that haulage is a large item of expense.

Call for bids on long stretches or big mileages of road in one locality to be built at one time, thus enabling contractors to use motor trucks or tractors for hauling and other special labor and time saving machinery.

Test all materials before use and see that the contractors live up to specifications. Also make certain that the most successful methods are followed in building brick and concrete roads.

Adherence to these policies will be pretty sure to satisfy all road users and taxpayers and win approval for the highway commissioner who adopts them.

NINETEENTH ANNUAL CONVENTION OF THE ASSOCIATION OF MANUFACTURERS

An innovation in the treatment of unemployment, namely, a discussion of the subject by leaders of industry representing establishments furnishing occupation for forces of workmen numbered by thousands, by hundreds and also in smaller groups, was one of the features of the nineteenth annual convention of the National Association of Manufacturers, held at the Waldorf-Astoria, New York City, May 19 and 20. Unusual interest attached to the unemployment conference. Business conditions of the country, the deterring influences now operating with respect to trade activities, and also the prospects in all the main lines of industry, were treated in detail.

PROFITS OF ALUMINUM WORKS

The report just issued by the Aluminum Industry Co., Neuhäusen, Germany, said to be the largest of the Continental aluminum companies, shows that, like the British company, in 1913 it has a good year, the net profit being \$1,288,000, as against \$883,000 in the previous year. The dividend is again to be 20 per cent. The present capital is \$5,000,000 and it is proposed to increase it to \$6,755,000. In view of the uncertain trade outlook it is said consumers of aluminum have been very cautious for some time in placing contracts, and the stocks in their hands have fallen to a low level, with the result that quick delivery is required for the contracts now being placed. It is announced that the International Aluminum Syndicate has still several years to run.

FORESTRY NOTE

The gross area of the national forests at the beginning of 1914 is almost a million acres less than at the beginning of 1913.

A PLAN PROPOSED

The Relations of Employers to the Problems of Technical and Industrial Education

Everyone who has studied the subject at all knows the intimate relation between the industrial standing of our country and the knowledge and the efficiency of those engaged in its industries. While this relation holds for all, from the humblest unskilled operative up to the corporation manager, it seems especially important to have those in the lower places realize it, since their educational opportunities are certain to have been the more limited. Thousands of boys leave school yearly from the lower grades to go to work. To most of these will come later a keen realization of lost opportunities and the absolute necessity of making up for them, for they enter commercial or industrial occupations utterly unfitted for advancement to higher positions. What they can do, how well their capabilities can be developed, will in most cases depend on what possibilities their employer brings to their attention and makes available. Most employers are well aware of this and try to help those who work for them to find ways of gaining the knowledge they need. Experience has shown that as a purely business proposition this pays. A young fellow whose character and habits of life are known, whose personality and ability have been tried out, is usually much to be preferred to any stranger when appointments are made to positions of large responsibility.

The scope of this article will not permit more than a passing word regarding the various educational agencies which have been made use of for the purpose of training men for advancement. Its main purpose is to point out some of the many educational problems which must be studied in order to decide upon the best plan of procedure in any given case.

Associations or clubs, whether local or branches of a national body, which meet periodically to hear an address or participate in a discussion are at best educational only in a supplementary way. Any study done in connection with them is not consecutive and usually to be beneficial needs a foundation which is too often lacking. The corporation school is rather new, and for every corporation large enough to organize and conduct one, has interesting possibilities; the tendency, however, is always to train for immediate usefulness in detail rather than in broad principles, while the variety of courses which can be offered is bound to be small. If, for example, the school is organized to benefit the workers in the shop, what shall be done with those in the business office who need an entirely different training?

A correspondence school, either within the corporation or outside its control, offers the only means of systematic study for those residing at considerable distance from the large centers of population, or where the number of persons interested in a given kind of work is too few to warrant the formation of a regular class. When schools can be reached where experienced teachers are in charge, where direct recitation methods are used, and where a variety of courses can be offered in a systematic way, the establishment of regular classes in off-duty hours offers the best method of giving the desired instruction. These usually take the form of night schools or evening classes.

Night schools have flourished in the last 20 years wherever established. Their advantages are fully recognized by those who have been attending them. Such are: immediate help over difficulties, procured by having an instructor at hand; the opportunity to learn by the mistakes of others in the class; compulsory regularity in study, so important even to a very earnest student; the stimulus of numbers; the desire to stand well in his class; the possibility of drill; and many others. Such school work, offered not only in the evening but in the late afternoons as well, is likely to have a remarkable growth in the future. To the general public the work which is being done as regards both scope and quality remains practically an

unknown quantity at the present time. Employers are just waking up to what has been and can be done in this way. No matter what educational agency is used, a number of problems arise which can be solved only by the co-operation of employers, employes, and teachers. What courses are needed? How much time can be required of busy men for school work? What fees are suitable? How shall those be accommodated who have long distances to travel and high car fares to pay? Should classes be established in locations remote from the schools, in shops or in offices, but under the control of their trained faculties? These are some of the problems which have never been fully answered. The answers would probably differ with a change in locality. Other questions are almost wholly the concern of the employer, such as: What school and what kind of education can best help my employes to gain what I want them to know? Which of them can profit most by systematic school work? How can I help to get it?

The only satisfactory way to reach a conclusion on these matters is to have some common meeting ground for all interests where free discussion can have full play. In Philadelphia steps to this end have already been taken. Last spring representatives of the Central Educational Institute of the Y.M.C.A., Drexel Institute, The Franklin Institute, School of Industrial Arts, Spring Garden Institute, Temple University, and the Wagner Free Institute of Science joined with representatives of the Philadelphia Trades Schools and the Philadelphia and Camden Public Schools in arranging meetings for the purpose of becoming acquainted with one another's work and the educational problems employers have to face. Wishing to avail themselves of the wide resources of the Public Education Association of Philadelphia, members of the faculties of the participating institutions are now organizing a section of that association to be known as The Industrial and Technical Education Conference of the Public Education Association. The membership is to consist of educators and employers, and the purpose is to seek earnestly the solution of the problems arising from the needs of the vast numbers of young people who have never had proper opportunities for securing that knowledge which will pave the way to better service and higher responsibilities.

It is hoped that the movement thus started will spread to include not only local representatives, but all those employers whose employes find in the large city opportunities which cannot be offered nearer. This means extending the work to a great many miles from Philadelphia, for classes could easily be arranged outside the city, managed by experienced teachers who are specialists in any given line of instruction.

HENRY V. GUMMERE,

Secretary of the Conference.

NEW WORM GEAR

In motor car construction there are two methods of transmitting power from the fore and aft propeller shaft to the transverse drive shafts within the rear axle. These are bevel and worm gears.

Advantages not possessed by the ordinary worm and bevel are claimed for a new gear, invented by two French engineers. Although the average motorist is rarely called upon to come in close contact with his rear axle gears, and may, indeed, have years of road experience without once seeing the inside of his rear axle, the manufacturer of high grade cars does not enjoy the same immunity from trouble. To get the high efficiency and the silence demanded by the car buyer of today, it is necessary to exercise extreme care in every phase of construction. Gears are cut on special and costly machinery, they are tested by means of instruments capable of recording variations of thousandths of an inch and of indicating the defective tooth; new methods are constantly being devised for hardening crown wheels without warping them and of removing the warp if any has been developed. Axles are tested individually for silence, and it is no uncommon thing for the axle

to be dismantled two or three times in order to secure the silence demanded by critical customers. The worm, so extensively adopted in England, is the reply to the demand for silence. But even here there are difficulties of construction, among them being lubrication, efficiency, and solidity of the mounting of the two members.

This is sufficient to show that while the mere owner may have a vague idea that something like finality is reached in rear axle gears, the manufacturer is perfectly aware that there is room for improvement and is ever on the outlook for new designs and for detail improvements in construction and fitting which will tend to make cars even more reliable, more agreeable to handle, less costly to maintain, and uniformly silent under all conditions of operation.

The invention is a worm gear of variable pitch with the worm mounted on the side of the worm wheel, and not immediately above or immediately below it, as is the case in ordinary motor cars. It is not claimed that this mounting of the worm on the side of the worm wheel is entirely new, but it is maintained by the inventors that this construction has never been fully worked out theoretically and has never received a practical application. There are cases in which a worm operates between two worm wheels, but this design is theoretically wrong, and, to operate at all, it necessitates a considerable amount of play between the driving and driven members. The Fleury lateral worm gear makes use of a single worm wheel, with which the worm engages absolutely without play; the worm takes up its correct position, at the correct distance from the center of the wheel, and it is impossible to place it otherwise.

There is an advantage—in many cases it is considerable—in the lateral mounting of the worm. With the ordinary worm having a tangential action on the worm wheel, the diameter of the worm is added to the diameter of the wheel, giving a rear axle casing so high that it interferes with the rear floor boards, or so low that it seriously diminishes the ground clearance. With the overhead worm it is frequently necessary to set the engine high, and with the underneath worm it is often necessary to incline the motor to secure a straight-line drive.

In the Fleury gear the worm has a thread of unequal pitch. This variation is constant and regular, there being no length on the thread where it can be said to be of a definite pitch. The result gained by this variation is that the worm or thread follows up the retreating tooth or stud mounted on the face of the worm wheel, and thus the full strength of the worm is always being exercised on the full strength of the tooth. Another important feature is that the teeth in actual contact with the worm are always immersed to their full depth. In the ordinary worm wheel gear only one tooth can be in full contact, while the others vary, the amount of contact before and after the tooth in full contact depending entirely on the size or diameter of the wheel. In the Fleury system, no matter what the size of the gear wheel, the contact of all the teeth touching the worm is complete to their full depth.

LACQUERING BRASS

Properly lacquered brass lends a most pleasing appearance to any finished instrument. I have found through experience that if the lacquer is not properly applied, in time it becomes dark and chips off. This is very discouraging, for it necessitates sandpapering off the old lacquer and applying new lacquer, which will not last any longer than the first coat. All this trouble can be avoided in the first place if the lacquer is properly applied. Below is my hard-earned experience in this line.

First, the brass must be given a fine polish. While there are several ways of producing a suitable polish, I find the following very simple:

To begin with, cut from some close-grained wood a circle about 10 inches in diameter. Through the center put a $\frac{3}{4}$ x 5 inch bolt. Next, heat some carpenter's glue and apply a thin, even coat to the surface of the wood. Sprinkle some very fine

carborundum dust on this and stand away to dry. After the coating is dry place the circle in the chuck of a lathe and, with the lathe running at high speed, hold a piece of steel against the wheel until the surface becomes quite smooth. After this, the brass may be polished without producing deep scratches in the surface. Round pieces of brass may be polished in the lathe by holding a piece of fine carborundum cloth tightly around it. After the brass is polished, avoid touching it with the fingers, as it leaves greasy spots. Next, place the brass in a clean iron vessel and heat gently. The lacquer is then applied in a thin, even coat with a camel-hair brush and the work set away in a dustless place to dry. The brass is heated for the purpose of expelling all moisture.—Contributed by Ray F. Yates to Popular Mechanics.

CHANGES IN PERSONNEL

The Emerson-Brantingham Implement Co. has appointed F. D. Moody, of the home office, manager of its branch house at Minneapolis. He will also have general supervision of the northwest trade. He will be assisted by A. S. Walrath.

A. T. Jackson will take charge of the work formerly handled by Mr. Moody at the Rockford offices.

H. L. Pierce has been appointed manager of the company's house at Sioux Falls, S. D.

These changes have been made for the purpose of improving the service in the northwest.

AUTOMOBILE TESTING

In a large automobile factory a curious method of testing the machinery previous to putting on the bodies is used. The motor and chassis are assembled complete with the exception of the wheels. In place of the rear wheels, two large pulleys are hung on the axle, and belts are run over them up to overhead fans. Pipes from these fans are led to the front of the chassis and curved downward so that air is blown down upon the motor, radiator and chassis. In this way the motor drives an actual load, accurately determined, similar to a road test, while at the same time it cools itself just as if it were speeding along the highway.

TRADE OF THE UNITED STATES WITH THE WORLD

A convenient reference book for the exporter or the manufacturer who is interested in foreign trade, is a Bulletin of Imports and Exports of Merchandise into and from the United States by Countries and Principal Articles, which has just been published by the Bureau of Foreign and Domestic Commerce and is sold by the Superintendent of Documents, Government Printing Office, for 15 cents a copy. A glance at this pamphlet affords the business man a bird's-eye view of the character and volume of our commerce with any foreign country, as it gives the quantity and value of its principal purchases from us and its sales to the United States for the years 1912 and 1913.

TO RE-MAKE OLD TIRE CASINGS

Under the name of the Motor Tire Re-Construction Co., a concern has been incorporated in New Jersey and started in New York to carry on a line of work which has been a marked success in Great Britain. This company is engaged in the re-making of worn out casings or, in other words, of going beyond the mere re-treading of a shoe in giving it the appearance and for all practical purposes the same construction as a new tire.

At a town in a southern state, is found painted on the side of the ex-stable this:

"For rent. Fords and Automobiles."

THE WIND AND THE CYCLECAR

There are three methods of seating in use in cyclecars; tandem, semi-tandem or staggered, and side-by-side. Each type has its particular field of usefulness, and its advantages and disadvantages, and each will survive in numbers proportionate to its merits. At present the greater number of American cyclecars are tandem seating, with staggered seating next.

The past has seen many cyclecars, from the single-cylinder air-cooled Crestmobile to the Orient Buckboard; cyclecars in idea if not in fact, for then the name was not invented and they were simply types of horseless carriage. With all of

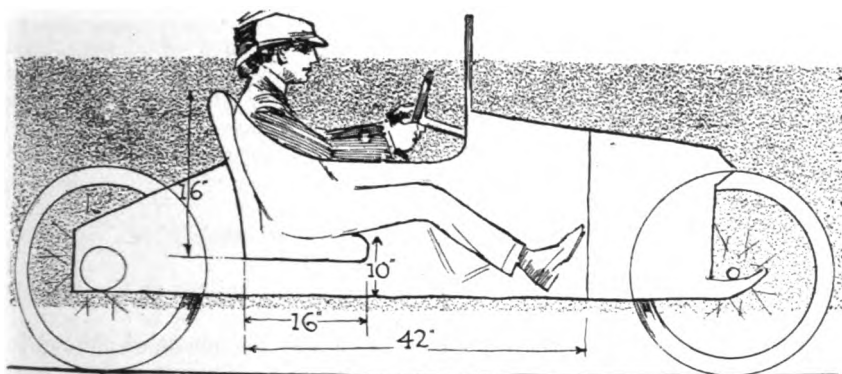

Dimensions of low-hung side-by-side-seating car. Tread and seat width should both be about 40 inches, for comfort

these and the O. T. A. V. in England—a side-by-side chain-belt drive car with the motorcycle motor built in London in 1907 and sold in small quantities—there was no cyclecar craze until Borbeau showed the new idea of tandem seating.

The Bedelia made its hit through its originality. It was a very crude affair, and unwieldy, but it held an appeal of sportiness and England took it up. At once the public spoke, and in the cyclecar movement saw only a new small motor car, and asked for motor car specification. The result is that the English cyclecar movement has failed—they only make small cars, many of them of indifferent success. No real engineer has tried to make a maximum-simplicity car in England and hence none has been produced.

Borbeau's idea in the tandem-seater was to get maximum results from minimum horsepower and weight. He started to produce a minimum-expense vehicle and did so—with the limitations of crude workmanship and scant capital.

In America tandem seating was tried first and with this was put some radical, though tried out, engineering. The result was the explosion of the theory that to be easy riding a car must be heavy. In the simple type, narrow-tread car was discovered a vehicle which gave a new class of performance.

The average public used to motor car arrangement is at a loss to understand why by far the greater number of cyclecar firms are building very narrow tread cars, and why those who build the wider tread and body types are fast adopting water-cooled motors above the cyclecar limit of cylinder dimension. The public off-hand wants to sit next to its passenger, and offhand and without too deep thought, speaks out for side-by-side seating. The makers feel that there is this feeling with the public and yet, knowing car limitations, many of them make tandem seating cars.

How Can a Tandem Body Be Sociable?

A properly built tandem body can be as sociable as any type, though many which have not been built with this idea in mind are not. How then can a tandem-seating body be

made sociable? How can maximum comfort be obtained from this type with maximum efficiency?

In the first place the weight must be as low as possible, this meaning that the passenger weight must be low hung also. This low weight is desirable for several reasons.

First, the lower the weight center the less power is needed to propel the car on rough places; second, the lower the riders the more protection from dust they will have with minimum height of sides and thus weight of car. A cyclecar must have better dust protection than a big car, and use every advantage to that end. Third, the lower down the riders are, the less danger there is of skidding or overturning, and the safer the feeling in the car. This safe feeling is due largely to the absence of side roll, as when road inequalities make the car roll or rock the riders merely pivot in their seats and are not thrown from side to side.

This is also one advantage of the tandem over other seatings, that the riders are sitting on the pivotal line and hence get a minimum of vertical jar.

Aiming then for low weight as the basis of comfort and efficiency the front rider, or driver, must be seated low. His seat should be as low to the floor as is consistent with comfort, and is shown in illustration as being 10 inches from the floor. Seated thus there must be a support for the knees or the legs will tire, so that the seat is made 10 inches long and slanted to support the rider under his knees. For the ordinary person about 42 inches is allowed from footboard front edge to the back of the seat, though with the low seat this length must be adjustable. The height of the seat back should reach to the shoulder blades and be at least 16 inches.

The rear passenger might be seated the same way, but this would bring him or her too far away for conversation. Also the rear seat should be a trifle higher than the front so that vision will not be hindered. By making this seat higher this vision is given and the seating position is raised enough so that the legs can remain vertical as shown, with the feet resting on the floor under the front seat. This is the greatest

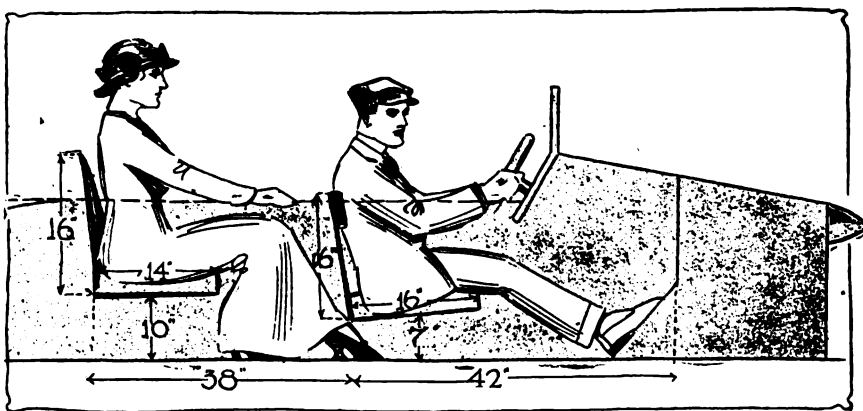

Typical dimension of tandem, for sociability. Foot space for the rear passenger is provided under the front seat

objection to building the transmission under the front seat, that it hinders the sociability by keeping the riders farther apart. By having the rear seat 10 to 12 inches high to the top of the cushion the rear rider has comfort, and yet is near enough to talk. The back of the rear seat should be almost vertical, and 16 to 18 inches high. The seat need not be over 14 inches deep, but at least 18 inches wide. The body should not be less than 22 inches wide.

The bottom of the car should be the floor board, and there should be no machinery exposed below. The clearance should be about 9 inches, for the usual 36-inch tread used with tandems.

The Side-by-Side Arrangement

With side-by-side seating the same item of low weight comes in, as a matter of efficiency, from several standpoints. In the first place the lower the weight the less the road resistance. Again, the lower the mass the less the wind resistance, and this, in the side-by-side type, is especially important. To build a side-by-side car aiming at motor car appearance is likely to make the public view the machine as a toy motor car instead of a new vehicle, so that the low-hung weight will give a new psychological impression, and a new appearance proclaiming a new type of vehicle.

For comfort the seats of a side-by-side should be from 36 to 40 inches wide, preferably the latter. To put this width on a 36-inch tread is a problem, except for good roads, though some have succeeded in it. As a rule a 40 or 42-inch tread is used, while some have gone as wide as a 50-inch tread, but mostly those in the small car with bigger motors than the cyclecar allows.

The seat should be about as high from the floor as the front seat of the tandem before described, as in Fig. 1, and the floor straight as before also, with about the same road clearance. This will allow of a cowl, like on the tandems, which comes

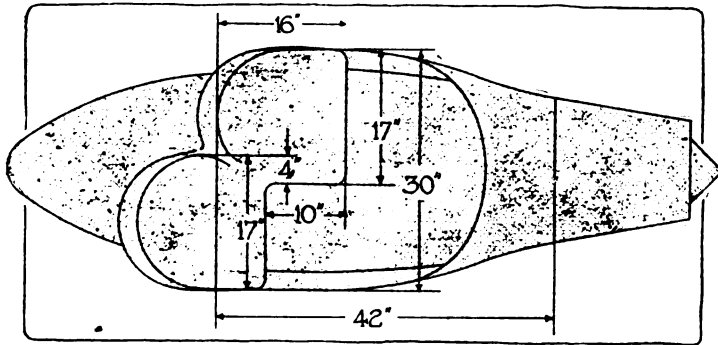

Car with staggered seats, the widths being reduced to 30 inches. The sociability of the side-by-side seater is retained, yet it has only slightly more wind resistance than the tandem

up high and hence which can protect the riders with a very small windshield, having little wind resistance. The frame can be narrow or triangular, with the point toward the front, and the seats overhanging, but a problem with the side-by-side is to get good dust protection, so that no construction should be taken which does not allow of high sides. The seat, to support the knees, must be deep as before, and well upholstered. The front room can be narrowed down if desired to point the car up front and lessen head resistance.

Staggered seating takes a half-way course between the tandem and side-by-side seating arrangements, and is rapidly gaining in favor. As before, the idea of keeping the weight low is of maximum importance and the seat heights should be carefully considered.

The driver's seat is generally placed on the left side, as on the Falcon, and the passenger's 8 to 12 inches to the rear and set in toward the center. In this way the entire width of the seating arrangement need not be over 30 inches and plenty of shoulder room still will be provided. The seats should not overhang the body in a way to interfere with sides being fitted for dust protection.

A CYCLECAR AND MOTOR BOAT COMBINED

A vehicle that combines the advantages of a cyclecar with those of a motor boat is obviously an interesting proposition, yet this is what the "hydrocar," designed by Leslie C. Lambert, of Drumchapel, Scotland, does, and it performs its work quite efficiently.

The body is a hull of three-ply wood coming to a point at the

stem, but having a square stern and a flat bottom, while a little deck forward takes the place of a scuttledash on the ordinary body.

The engine is a $4\frac{1}{2}$ h.p. single cylinder with water cooling, and on the road it drives the offside rear wheel through a chain and a two-speed gearbox.

A dog clutch, however, enables the drive to be transferred from the road wheel to a bevel drive for a propeller at the rear when in the water.

The rear springing is by a transverse spring, and forward by a central spiral spring a la Bedelia. The front axle is that from a Riley tricar, and a flat piece of wood attached to one of the front wheels act as a rudder, so that the control is identical on land or water.

The vehicle runs very nicely on the road or in water, but the one wheel drive is not, of course, perfect for taking the car out of the water and up a bank. Front wheel drive or even four wheel drive is the ideal under such circumstances.

Mr. Lambert has proved the possibility of building a practical vehicle of this kind.

NEW DESIGN OF WAGON

F. M. Foltz, of Urbana, O., is the builder of the interesting wagon here described.

Unlike the ordinary farm wagon, this one can be drawn from either end, both gears turning and provided with a tongue. The front and rear gears are fastened together with chains that cross in the middle of the reach, but held in position by pulleys fastened to the reach. These chains cause the two pairs of gears to operate so that it is possible to turn the wagon completely around in half the space ordinarily required. In turning, the front and rear wheels track. The wagon was invented by George Bulles.

We think the idea of the wagon is not new, save in one or two of the details, and the patent would be hard to sustain in view of previous performance along these lines, that will easily be called to mind.

AMERICAN CO. DEAD AND GONE

Although it is was hoped that a company would be organized for the purpose of bidding in the property and assets of the American Motors Co., which were bought some time ago by Samuel L. Winternitz & Co., Chicago auctioneers, who purchased it for speculative purposes, all hope was disseminated when the good will of the bankrupt company, patents, jigs, dies, etc., passed to the Levene Motor Co., of Philadelphia, for \$4,000. Subsequently all of the supplies, finished cars and parts were struck down to the Auto Parts Co., Chicago; hence the American Motors Co., as a manufacturer, has passed out of existence.

RESULT OF A LOCAL CONVENTION

At the annual convention of the Pennsylvania Motor Federation, at Erie, Pa., the following officers were elected: President, Robert P. Hooper, Philadelphia; vice-presidents, Albert H. Jarecki, Erie, and Peter Meixell, Wilkes-Barre, Stedman Dent, Philadelphia, David Johnson, New Castle, John M. Core, Uniontown; secretary and treasurer, Paul C. Wolff, Pittsburgh.

The city of Reading will get the convention next year.

THICKNESS IN THOUSANDTHS OF INCH

While to the uninitiated it may sound almost marvelous to refer to measurements of thousandths of an inch, it really is an extremely easy matter to arrive at such dimensions with modern instruments. With a micrometer caliper it is as easy to measure the thickness of a piece of paper as it is to measure a pencil with a foot rule.

THE CHEAP CYCLECAR MOTOR

The future of the cyclecar depends on the development of a cheap, reliable, efficient, well-balanced motor of not over 71-inch capacity, and it is not improbable that the very demand for cheapness and simplicity may lead to the adoption of some type of four-cylinder motor.

Present motors as used on cyclecars are surprisingly efficient and fairly well balanced, but while the twin cylinder V-type motor sounds simple, the present constructions are too expensive to continue as cyclecar possibilities. Some of the present

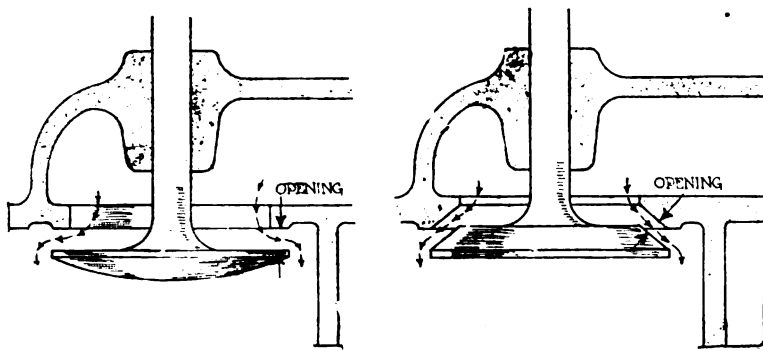

Fig. 1—Fiat valves give greater opening for the same valve lift and have greater possibilities for high-speed work

V motors have more parts than a four and hence are less reliable. Their weight is about what is wanted—not over 100 pounds, but engine makers say that they can build fours with water cooling which will not weigh more. If this be so, and the cost is less than the V, then four-cylinder motors will come. The cyclecar is a cost proposition, is the opinion of W. B. Stout, who has digested foreign practice, and warmed it over for the good of those who are facing difficulties. The illustrations are from Automobile.

The chief trouble with the small motor is rings. If those in a cylinder under 2¾ inches diameter are made as stiff as they should be to stand up to the work and hold the gas, then they are too rigid to spring over the piston and into the grooves without distortion or breakage. If they are thin enough to slip over without distortion or breakage then they are not stiff enough to hold up to the work. This is especially true on air-cooled motors where the rings are subjected to great heat.

Fig. 2 shows three ways in which this difficulty may be overcome, the first by screwing an apron A up over the piston head which supports the piston pin, this apron screwing up to hold the two rings in their sockets so that they do not need to be sprung into place. The second shows how the rings with a spacing ring between can be slipped into place and a plate B riveted down on top to hold them in place, a type used when magnalium is the piston material. The third is a type where the cylinder head C screws into the piston. This type can

support the piston head as first shown but is better if the pin bearings are hung as at D from the screwed-in head.

There are a number of reasons why a four-cylinder motor should be cooled by some external system other than air-cooling. In the first place air-cooled cylinders take up space and hence add a certain amount of weight. By casting in block also four water-cooled cylinders can be made cheaper than air-cooled cylinders. It is very difficult to cool the third cylinder of an air-cooled motor, the rings on this cylinder wearing out very quickly. This is no problem on the water-cooled. With the block type the entire motor can be largely in one piece, cylinders, crank case, intake and water jackets, and in these small-length castings the exhaust as well and the valve housings and water leads can be included. Crank case cover plates can be pressed steel as can also be the lower half of the crank case, to save weight. These castings can be made as thin as ⅛ inch and hence the block casting, say in semi-steel, will weigh no more than an air-cooled outfit of the same capacity.

Bearings Should Be Plain

The bearings should be plain on account of noise. A ball bearing in a motor reverberates all through a cyclecar, giving a roaring sound from the body when the motor is in action. With the plain bearings a force feed oiling system is advisable. The bore-stroke ratio for this work should be in the neighborhood of 1 to 1½ and the connecting rods long in proportion, as the small pistons have little surface to take the side thrust.

Small pistons and rods allow of very light weight and these should be of the very best quality. The best of steel will allow of very light connecting rods while featherweight pistons are an everyday occurrence nowadays. Balance will be a real problem in these little motors which will be running often at 3,500 revolutions per minute, and which will have to be built to stand speeds of this or even higher rotation for sustained periods.

For the small motor of ultra-efficiency overhead valves have great advantages, and can be made very quiet as well.

This type of valve, driven by an overhead cam shaft, as on the Weideley motor, for instance, can be inclosed and run in oil, insuring perfect lubrication and absence of click, and the cams can act directly on mushroom tops to the valves. The valves need not be large, for a flat valve in this small size will hold the gas excellently and can be made self cleaning. A flat valve will pass a great deal more gas than a beveled faced valve for the same opening as in Fig. 1 and hence has great advantages for quick opening and closing or for noiselessness. This type operated by the overhead cam shaft would be very cheap to build. The valves also would be faced in the same operation of reaming the cylinders. This construction too, would allow the entire valve seat to be surrounded by water, as in Fig. 4, a point which will add greatly to valve life.

In overhead valve construction there should be no possibility of valves breaking and falling into the cylinders, so that valve stems should be extra large and the material of the best.

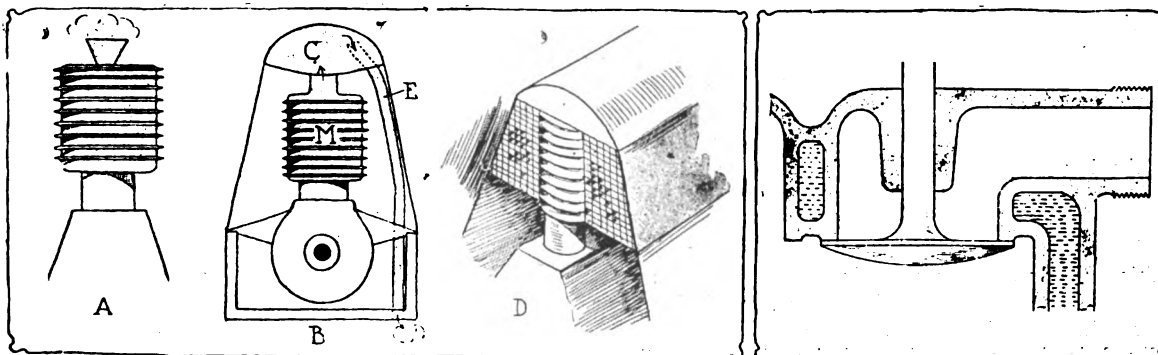

Fig. 2—A, hopper cooling; B, addition of condenser to hopper cooling; C, addition of condenser to hopper cooling; D, compact arrangement of radiator along cylinder walls

The design may include pockets to catch the valve if it does fall, but a cheaper way is to allow the length of stem that will preclude breakage.

Economy in Castings

The intake passage can pass through the water jacket, and, as stated, the exhaust manifold can be unit with the main casting. The bearings should be in the upper half of the crank case, so that the removal of the bottom of the crank case or of the engine from it will not disturb the assembly.

The cooling of a cyclecar motor will not be different from that on big cars and it is possible, and almost probable, that the eventual motor will water cool without the expense of radiator connections, or possibly even of radiator. A development of hopper cooling as used on farm engines will be one line of growth and a thoroughly reliable one, having the advantage of running the motor at a higher heat than on present motor car types, an advantage with the present grades of gasoline.

In hopper cooling as in Fig. 3 at A, plenty of water space is allowed around the cylinders and at the top a large outlet with a funnel shaped opening is left. The water in the jackets can never get hotter than the boiling point and hence the cylinders work always at this even temperature. When the water

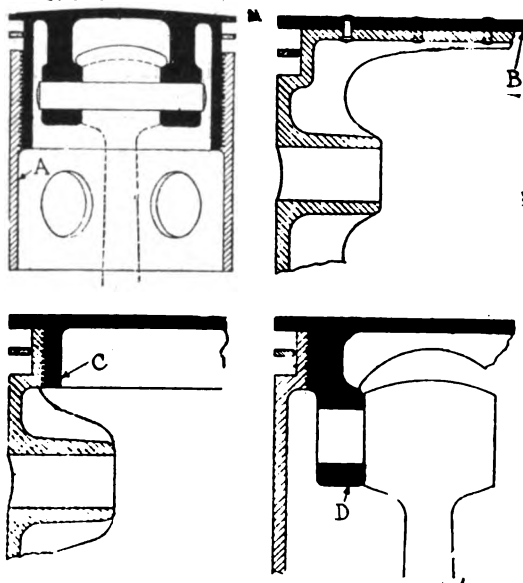

Fig. 3—The entire seat of the overhead valve can be directly cooled by water jackets

boils away more is poured in to take its place, when stops are made for gasoline.

To use this as in farm engines might require too much weight of water through air fins on the outside of the hopper would save a great deal through radiation of the water heat.

To catch the water in a condenser above the motor, even though this were but in the form of a tank at front or better at the rear of the car would be to save a great deal. This water after cooling could be arranged to flow back into the motor again. A form of this system is shown at B where M is the motor, C an open condensing tank of sheet metal. For ordinary running the tank area would cool the water enough to return it to the hopper and when heavy pulling made it boil beyond the capacity of the crude condenser then the overflow of steam could be conducted below by the pipe E leading from the top of the condenser tank C to a point under the car. Motors of this type have been used in aeroplanes with good success, the Antoinette machine using a motor of this type, using condenser instead of radiator.

At D in Fig. 3, is shown a method of clamping the radiators on the side of the cylinders, this making an ideal and compact thermo-siphon system with minimum parts and weight, the

idea being used on the Green engines of British manufacturer used for motorcycles. This form can be made to merge into the hood design very handily.

There is need for a new cooling system for cyclecars and to fit the heat requirements of present day gasoline. On the development of proper pistons for small sized motors and adequate cooling system at less cost and weight than present type depends the success of the four-cylinder motor on cyclecars. The weight should be under 100 pounds complete with water and the cost under \$75 in quantities. If a motor can be built to sell for \$50 as is easily possible without skimping workmanship, it will have just that much greater field.

The crank shaft of a cyclecar motor can be of the two bearing type on account of the short length of the motor. The connecting rod bearings, however, will need to be larger in proportion than on a big car motor and the oiling systems for the whole machine will need to be perfect. A splash system with a constant level overflow supply will work very well so far as the cylinders are concerned and the connecting rod bearings, better by far than in a big motor where the distance is higher and the revolutions per minute lower, the main bearings will need special oiling, however, and plenty of it.

Ignition can be by magneto, but battery systems today are so reliable and give such wonderfully easy starting that coupled with a lighting system for less price than the magneto, they are likely to continue. They weigh less and cost less.

WIND A FACTOR IN CYCLECAR DESIGN (ALSO IN SELLING)

Though one build a cyclecar for touring, he must remember the wind, and this is one of the greatest arguments for tandem seating that advocates of this type put forth. With a side-by-side car a nine horsepower motor will have a hard time pulling a windshield and top against a 30 mile wind. These cars will need bigger motors for this work. With the tandem, streamlined, and with the small type of top and windshield they use a 30 mile wind is nothing.

Given 10 square feet of area on a side-by-side seater, and it will take from 9 to 12 horsepower to drive the car 20 miles an hour against it. In the narrow types with narrow tread, four square feet of wind resistance is all that is necessary, and a 9 horsepower motor can safely handle the car.

The cyclecar is a new vehicle. It needs new engineering. It needs designers who are rational and posted and yet who are unprejudiced by previous practice. It needs aeronautical engineering, motor car engineering, art engineering, pressed steel engineering, metallurgy, mathematics and all the brains that can be combined to produce a maximum efficiency car. Give us this performance and looks and it is bound to be a low-priced reliable car and a salable proposition.

ABOUT TIRES

France has the credit of being the first to manufacture a practical commercial detachable double-tube pneumatic tire suitable for motor cars. The average man can scarcely appreciate the consummate skill required to initiate and manufacture the Michelin tire. The motoring world undoubtedly owes a deep debt of gratitude to the pioneers of the motor tire industry. The objections that might be urged against the Michelin is that it requires skilled labor to manufacture it and is therefore a trifle too expensive and all the threads in the fabric are not subject to the same strain.

THE CENSUS

There are 85,000 commercial motor vehicles now in use in this country. Four thousand are to be made in 1914 by the 27 American builders.

Paint Shop

PAINTING BUSINESS WORK—SOME HANDY MECHANICAL PAINT SHOP HELPS

In painting wagons and trucks from the new wood the item of chief importance is to get the wood saturated with a sufficiency of pure, raw linseed oil, carrying enough pigment to prevent the oil from striking too deeply into the wood. For this purpose perhaps there is no better combination of pigment than two parts of white lead ground in oil and one part of

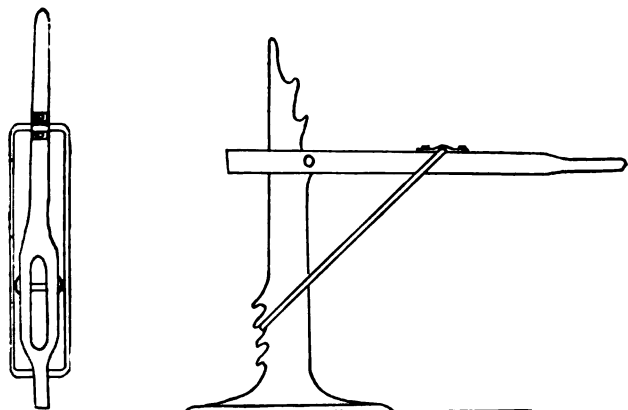

Fig. 1—A simple, strong jack for use in the paint department

finely ground yellow ochre. Use just enough pigment to stain the oil and check its penetrative property.

For the second coat, take of the color chosen for the finish of the vehicle and use in the mixing three-eighths oil to five-eighths turpentine, with a gill of good coach japan added to one-fourth gallon of the paint. On this coat when applied and dried out firm and strong, putty all necessary parts, using enough of the color in the putty to bring it out to the proper shade or tint. If the body of the wagon has any coarse-grained, open-textured wood, such places should be glazed over the priming coat with the ordinary carriage putty, cut to a glazing consistency with turpentine, writes A. F. Grailing, in American Blacksmith, who seems to take his present viewpoint from the ground of doing everything in the shop, and temporarily passing up ready-made fillers that are excellent. Use a 2½-inch blade putty knife and make the putty thin enough to work readily from the knife. Press the glazing material firmly into the wood and remove the surplus material in order to reduce sandpapering to a minimum. Over the second coat of paint use the finish color in the form of color-and-varnish for ordinary grade work. For a better grade use an additional coat of flat color and then the color-and-varnish. Deadens this color-and-varnish coat, when dry, with a tuft of curled hair obtained from the trim shop, and stripe and finish.

Over old surfaces no painting should be done until all scaly, shelly paint has been sanded or scraped off and a solid surface exposed. Then carefully proportion amount of oil for the first coat to the condition of the surface.

Surface for Business Wagons

The heavier type of business wagon, and the class that usually comes to the country painter, need not necessarily be coated up with roughstuff, unless the surfaces are unusually large. When not to be roughstuffed, prime as above advised and glaze the surface carefully with glazing putty. Then when this has hardened sufficiently, sandpaper it very smooth and coat up with

color, sandpapering between coats to knock off all nibs and dirt atoms and to keep the surface smooth.

To use roughstuff for this work, apply over the primer a coat of roughstuff mixed with three parts lead and two parts filler (by weight), mixing it to a stiff paste with coach japan and rubbing varnish, equal parts, and thinning to the proper consistency with turpentine. After 24 hours, sandpaper smoothly and glaze with glazing putty. After another 24 hours, apply a coat of quick roughstuff, following nine hours later with a second coat of quick stuff. Then, in due time, face down this surface with rubbing stone and water.

Using Elastic Varnish

For the permanent good of truck, farm and business wagon painting (the paint surfaces of which are built up largely of elastic pigments), elastic varnishes, rather than the quick, hard, drying ones, should be used. This, of course, is contrary to ordinary practice, but it is nevertheless founded upon experience. To coat elastic surfaces with hard, inelastic varnishes is simply another way of sowing the wind to reap the whirlwind, and results in cracked and fissured surfaces. The elastic foundation carried through to the varnish stage should have an elastic varnish to protect it. This provides requisite harmony from the first to the final coat.

The small or jobbing shop painter will find it most economical to buy his varnish in small cans, pints and quarts, as the needs for various quantities arise. Provide a good rubber stopper for the can in use and keep the varnish in a clean, temperately warm place. Large cans of varnish unless used up quickly soon thicken by reason of its natural evaporation and so it soon requires an addition of turpentine to permit its proper use. This destroys the luster and brilliancy to a considerable degree,

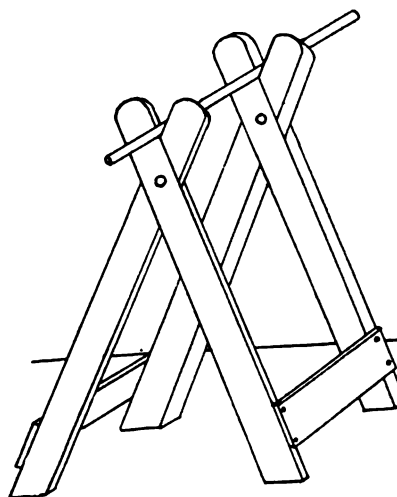

Fig. 2—An easily made wheel horse

and best results are impossible. Lack of proper handling of varnish is more often responsible for poor results than are the surroundings and local skill and conditions generally.

Hints, Facts and Formulas

The best way to paint the canvas-top wagon is a vexing question in the average country shop where this wagon is a frequent visitor. Here is a suggested formula to try on the next canvas top that comes in: Treat the new canvas top with two sizings of hot glue water and allow about 24 hours

between each coat. Then apply a coat of white paint mixed as follows: white lead, ground in oil; $\frac{5}{8}$ raw linseed oil and $\frac{3}{8}$ of a half and half mixture of coach japan and turpentine. This should reduce the lead to a brushing consistency. For the second coat of paint, after an allowance of five days for the first one to dry, mix the lead in $\frac{1}{4}$ raw linseed oil, $\frac{1}{8}$ coach japan and $\frac{5}{8}$ turpentine. Allow three days for proper drying,

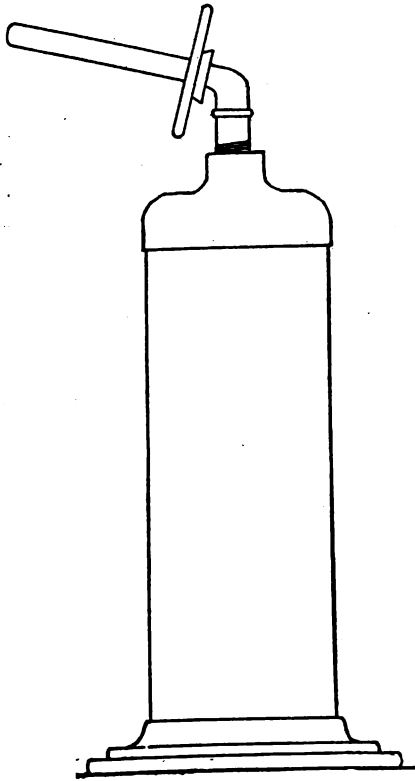

Fig. 3—Another wheel horse of good design

and then sand off lightly and apply white color and varnish. Rub this coat sparingly, letter and ornament and, in due time, finish. For a quicker finish add four ounces of white vitriol in a gallon of water and use bolted whiting until a spreading consistency is reached. Coat top and curtains and apply the desired paint directly upon this whiting-vitriol foundation and finish in the usual way. This develops a quick, clean finish at less expense than the regular glue size formulas.

The next suggestion is one that some painters may think rather unnecessary. It is this: strain your colors and varnishes. This little matter of straining your materials may make just the difference between a good job and a poor one; and especially is this true when materials have stood for any length of time. Try as we may, dust and other foreign matter will accumulate and somehow get into the tightly-closed can. Cheese cloth cut into 8-inch squares, and clasped over the paint or color pot, furnishes useful strainers. Varnish should also be strained as a matter of precaution. The best carriage body finishers in the country, the men who turn out works of art in the leading shops and factories, invariably strain varnish before using. If a good practice for the specialist, why not equally good for the painter in the small shop where conveniences and facilities are, at best, not conducive to mirror-like surfaces?

The average small shop painter is very likely, when using carmine, to use more of this color than is usually necessary when preparing this beautiful pigment for use. The main consideration is to get the ground color as perfect as the glaze coat should be. When a perfect ground is obtained, all the glaze coat is expected to do is to enrich and bring out the beauties of the ground color. For this purpose, only sufficient carmine is used to stain the varnish strongly—a proportion of

about $\frac{3}{4}$ of an ounce of carmine to a full $\frac{1}{2}$ gallon of varnish. Used in this proportion the glaze coat works freely, flows out well and displays a good measure of brilliancy.

The shop mixed black-color-and-varnish—and in the country paint shop this is a common article—all too often carries too much color in proportion to the quantity of varnish. The result is a mongrel surface—an unfortunate medium between a dead color and a surface of great brilliancy. And over such a color the varnish is pretty sure to crawl when the temperature is not quite right. Varnish color, whether shop mixed or bought of the varnish maker ready for use, should carry sufficient varnish to furnish a surface of good brilliancy both at the time of application and when it is dry.

A good sure putty for the jobbing painter may be made of three parts dry white lead, one part gilders' whiting, and equal parts of quick rubbing varnish and coach japan. This putty will dry to sandpaper freely in 24 hours. A putty especially intended for deep holes and cavities is made of one part dry white lead and three parts whiting mixed in equal parts of raw linseed oil and coach japan. With this mix in enough plush wool, picked carefully apart, to give the putty great adhesion. At the bottom of the hole drive some tacks and then crowd the putty into the cavity, filling it nearly level with the surface. With the point of a penknife slash the putty a couple of times quite deeply to hasten drying. Then, when this bulk of putty has dried hard, re-putty, filling level with the surface and using the regular hard drying putty as above described.

The country painter is bound to get some old carriage or wagon surfaces badly cracked and fissured which the owners want fixed up in the best way possible on the old paint. Take equal parts of rough-stuff filler, dry white lead and whiting, and mix to a stiff consistency with equal parts of coach japan and quick rubbing varnish. Apply this mixture with a stiff bristle brush, working the pigment well into the cracks. Let the mixture stiffen up considerably, and then with a $2\frac{1}{2}$ -inch blade French scraping knife work over the surface, pressing the pigment well into the fissures. Permit this to dry for a couple of days, and then rub out with a block of composition rubbing stone dipped in raw linseed oil instead of water. After rubbing out, allow the surface 24 hours in a warm, dry air to season, after which it may be brought to a finish in the usual way.

Information imparted to the owners of vehicles, like bread cast upon the waters, may, after many days, return with profit

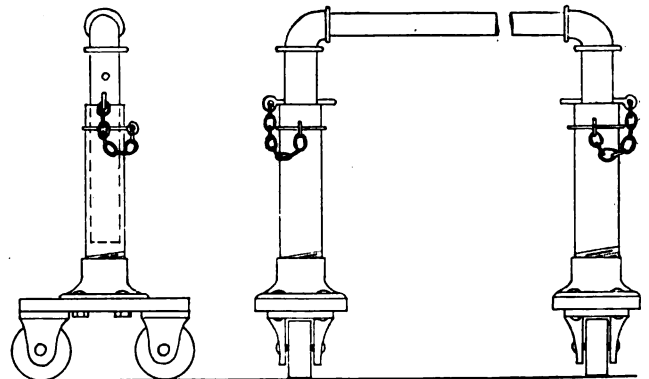

Fig. 4—A gear trestle strong enough to carry the largest gears

threefold. Do not be afraid, therefore, to give special advice to your patrons relative to the care of the carriage.

Labor-Saving Appliances

In order to handle farm wagon and truck equipment economically and with a minimum of labor it is necessary to have heavier and somewhat different devices than are used in the average carriage paint shop. In Fig. 1 is shown a very simple yet strong jack. This can be made very easily and cheaply or,

if preferred, good jacks can be purchased from any supply house. There are a variety of patterns, styles and grades to satisfy most any personal ideas and any purse. But perhaps the most important consideration is to purchase a jack that will be strong enough for the work required of it. Don't endanger your life by using cheap, unreliable jacks which may break at a critical time. A simple wheel horse is shown in Fig. 2. This, however, is not as handy an appliance as the one shown in Fig. 3. This latter wheelstand can be made to handle the heaviest wheel that comes into the shop. It is made of suitable sized pipe and flange fittings—depending upon the size and weight of the wheels to be handled. The standard of the appliance is then weighted by filling the pipe with gravel or iron filings or any other cheap or waste material. Or if the stand can be permanently located in some well-lighted spot in the paint room it can be bolted solidly to the floor.

In Fig. 4 is shown a gear trestle that will carry the heaviest vehicle likely to come to your shop. It is fitted with extension posts, so that after being placed, the gear can be raised to an easy working height. This trestle is easily and cheaply made, and if any considerable amount of painting is done it will save many a backache. The trestle may be made of any suitably sized pipe, depending upon the weight of work usually done.

PICKING OUT AND FINE LINING

Disproportionate spaces and widths of the lines relative to the surface under treatment will produce a heavy and scattered effect. Too wide or too narrow spacing creates effects repellant to the sensitive eye, and, until a workman has been well educated to appreciate these varying effects, he is sure to make errors in his work. In the following diagrams are given various examples showing the effects of good and bad proportions, and their teaching is applicable to every part in which picking out and fine lining are used as a decorative element on the finished work.

In motor car wheels the most usual practice is to paint felloe and rim in the body color, or some color that will harmonize

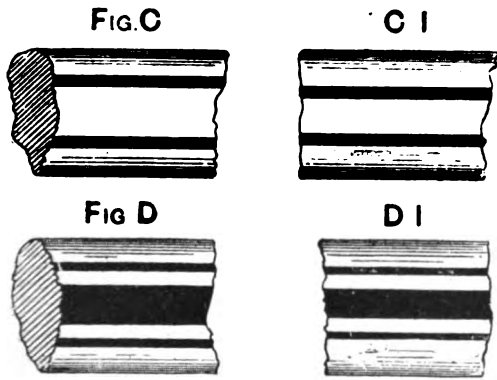

with it—in which case the chassis frame and all the under works are often painted in this harmonizing color—quite plain or at most with one fine line and a small piece of relief, like an arrow head, at the base end of each spoke. The striping and fine lining associated with the horse-carriage wheel find practically no place on motor vehicle wheels.

Fig. C shows part of a spoke with fine lines too widely spaced, while C I shows the much improved effect of placing them closer together.

Fig. D shows a spoke picked out and fine lined in a style much too heavy in relation to the surface, while D I shows the more pleasing effect of better proportion.

Fig. E is an example of picking out without fine lines, in which case it is legitimate, and in fact necessary, to make the stripe wider, but in this connection regard must be had to the diameters of the wheels under treatment, for obvious length and size of spoke will necessitate a width of line to correspond.

E I shows a narrower line and one better proportioned to the surface.

In Fig. F the picking out line is split by a fine space which materially lightens and balances the effect in the case of a long spoke, and in Fig. F I we have the same thing but both lines made finer to suit a long but small spoke.

Instead of the split picking out line a good effect is obtained as shown in Figs. G and G I in which the center line is edged on either side by very fine lines.

Schemes of decoration which depend upon the exclusive use of very fine lining on body panels should be avoided as much

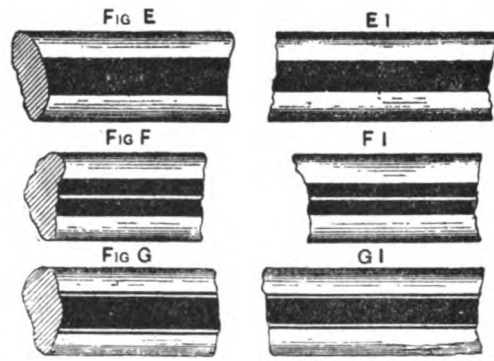

as possible for the reason that it does not harmonize well on any but spider designs of carriage work, and even then it is apt to give an over-elaborate and gaudy appearance if done sufficiently to show up, while if not so done, it is too insignificant and generally might as well be omitted.

In carriage or car decoration good taste is everything, and this faculty is acquired only through careful study and constant practice.—Cooper's Journal.

THE SECRET OF GOOD VARNISHING

Really there is no secret about it at all. It is as plain as the open book, in fact. You are aware, doubtless, that the nervous, the fussy, the pottering painter never made a good varnisher. The workman of courage, of confidence, of fine skill, who lays on varnish with a rich flow of material, who studies the work in every detail and from the standpoint of a student never too old or too proud to learn, is one who knows the secret—or the simple law, if you please—of good varnishing.

Varnish rooms are rarely perfect, and, as a rule, decidedly deficient in many features which belong to an apartment where the daily work is highly difficult and extremely sensitive to varying weather conditions. Many of them are ill-provided with the furnishing which should be a feature of every varnish room. However, the varnisher of capability is proof against all the manifold disadvantages centering in the varnish room, and philosophically goes about making "the best of a bad bargain," or whatever sort of a bargain conditions may chance to furnish. And this is the temperament, coupled with skill, which lays bare the so-called secret of the varnish room and gets at the heart of things in a way to make good varnishing the rule.

HARD WOODS IN THE PAINT SHOP

Mahogany is an open-grained wood to the extent that it requires a good paste filler. The texture of a mineral filler does not shrink; neither does it discolor with age. After choosing the base of the shop-mixed filler, mix it in equal parts of raw linseed oil, coach japan and turpentine. Mix the filler first in the oil, then add the japan, and stir in the turpentine until a brushing consistency is reached. Apply the filler to the surface with a bristle brush and permit the coat to dry until it takes on a dead appearance due to the evaporation of its natural gloss. Then proceed to wipe the filler across the grain of the wood, using a tuft of tow. Have the grain of the wood com-

pletely filled, otherwise the finish will prove defective. After wiping off the surface stand aside until the following day, at which time, at reasonable intervals, apply a couple of thin coats of orange shellac.

Allowing 48 hours or 72 hours for the material to dry apply two coats of very pale rubbing varnish, lightly sandpapering the first coat. Should it be decided to make the finish in a polished surface rub the second coat of varnish with water and pumice stone flour to deaden it perfectly and apply a coat of straight polishing varnish. When this coat has dried thoroughly rub it with water and pumice stone flour, then with rotten stone and crude oil; next saturate a tuft of soft fabric with good varnish polish and proceed to work hard and firm on the surface until a high polish is wrought. Varnish is polished only by friction. First class wood finishers finish the work of polishing by using the palm of the hand held firm and worked briskly in circular motions until the friction thus created develops a deep, high brilliancy. After the full polish is secured moisten a wisp of white cotton waste with denatured alcohol and pausing until evaporation has left but a slight vapor, proceed to "spirit off" the polished surface. This will clear up any appearance of cloudiness and bring out the high, sharp brilliancy of the finish. The advantage of the polished surface for automobile interior parts finished in the natural wood is that the surface does not easily mar or disfigure or show finger marks or other evidences of handling.

NEW WAY TO STENCIL

In ordinary stencils there are two difficulties to contend with: first, to put the ties in such a position that they firmly hold the different parts of the stencil together and next to have the design cut sharp and clear, which in the case of small or intricate designs is sometimes difficult.

A new method consists of painting or drawing the design on a specially prepared material. This design is then painted all around with ordinary shellac varnish. When this is dry a moistened sponge is passed over the design itself which has not been touched, and this wipes away the material but leaves behind an open fabric or gauze which successfully holds the parts of the ornament together, however intricate they may be. Those who are acquainted with Japanese stencils will recognize in this process something similar in character. The Japs are fond of making stencils very fine in their character and of cutting two on thin paper, inserting a netting of very fine hair and then sticking the two together.

The simplicity of the method is very considerable, and it is claimed that stencils made in this way possess superior artistic effects and are much cheaper than ordinary stencils. When the improved stencil is made it is used exactly in the same way as an ordinary stencil.

REPAINTING AN AUTOMOBILE

I should like to submit a few suggestions regarding the preparation and the painting of an automobile, writes J. T. Archer. There are lots of different things that we have to contend with in cleaning an auto, and getting it ready to paint or varnish.

First of all, I would suggest cleaning the chassis thoroughly with gasoline and a stiff paint brush. Take an old brush that you have almost worn out, or which wastes more paint than you get on the job.

Boil this brush until the paint is all out and then use it to scrub off the grease on automobiles. Use for nothing else. Use plenty of gasoline; being careful not to use near store or artificial light.

After you have done this go at it with No. 2 sandpaper, and proceed the same as with a wagon; but be sure and have your job free from grease.

Remove the front wheels, but do not attempt to remove the

back ones, as they are generally fastened more securely, on account of the driving system.

If it is not too much trouble, and you are not cramped for room, remove the body from the chassis; or, in other words, the running gear. This will give you a better opportunity to get your job clean, for upon this a great deal depends.

Carefully remove all plated and polished parts of the auto, such as lamps, handles and plates, as this also will save a great deal of time in cleaning the paint off.

In conclusion, permit me to suggest, that, if the machinist is working on the car at the same time, which is often the case, get the job ready to finish, and then put it together before varnishing for the last time.

You will thus have much better results, if you have any touching up to do; for a machinist is not at all gentle around an auto, regardless of its condition.

An automobile requires very different handling, and more consideration than a carriage or wagon, and only a wide-awake painter will get good results.

USE OF STRIPING PENCILS

It is a good plan to save the sword and dagger pencils as they become worn down and unfit for rapid work. When several of the pencils have thus been accumulated they may be taken apart and the long hairs removed and reassembled in sufficient stock to make new pencils. This long stock from worn pencils makes the very best kind of fine line pencils, being springy, strong and resilient. Sometimes it requires the hair from three pencils to make one new pencil, but even on this basis it pays. The camel's hair from swan quill pencils makes up finely for sword pencils. While such stock costs a little more money to buy, it pays ultimately, not only from the standpoint of superiority of working, but additionally from the greater durability secured.

All sword pencils require a clean washing out after use in order to maintain them at their best. If the washing out is not thorough, and fails to eliminate the pigment accumulations in the heel of the pencil the natural elasticity and buoyancy of the tool is quickly destroyed. The stock should then be dried out by rolling the pencil handle rapidly between the palms of the hands. Then in greasing the tool take the lubricant between the thumb and forefinger of the right hand and press carefully into the stock, working the grease quite down into the heel of the pencil. The preservation of elasticity in a pencil amounts to little if such preservation consists in merely taking care of the actual working point of the pencil.

A mixture of equal parts of beef and mutton tallow furnishes about the best all-round pencil lubricant and preservative extant. While sufficiently soft and pliable it is at the same time stout enough in body to hold the stock of the pencil in the exact form and position desired.

Under no circumstances should striping pencils be pasted up against the show window glass. In such a position they soon become saturated with dirt and dust, and their elasticity suffers accordingly. A tight, dust-proof pencil box in which the pencils may be stored, free from molestation and from accumulating dirt, is indispensable.

GLAZES

Various tones of the red order may be obtained by glazing scarlet, crimson, rose, maroon and madder lake over such grounds as above indicated.

Verdigris, a descendant of copper, glazed over gold leaf, or even over gold bronze ornamentation, produces wonderfully luxurious effects. Deep yellow and ochre grounds invite glazing with verdigris and certainly the effect produced is quite worth while.

Lines of light blue are greatly enhanced in the matter of fine looks by glazing with either of the three shades of ultramarine blue.

Smith Shop

SIMPLE WEIGHT LIFTING DEVICE

Many smiths have no weight lifting devices in their shops, and when called upon to overhaul a car have difficulty in lifting out the motor. The device illustrated in the accompanying engraving, taken from *The American Blacksmith*, is simple, low in cost and yet is very serviceable in lifting out motors or raising other heavy parts. Two chains (trace chain is just the thing to use) are hung from the ceiling or from a beam in the shop. These chains are best put up only temporarily at the point where needed. Then fit up a stout pole or piece of pipe as shown in the engraving. The hooks at AA work freely

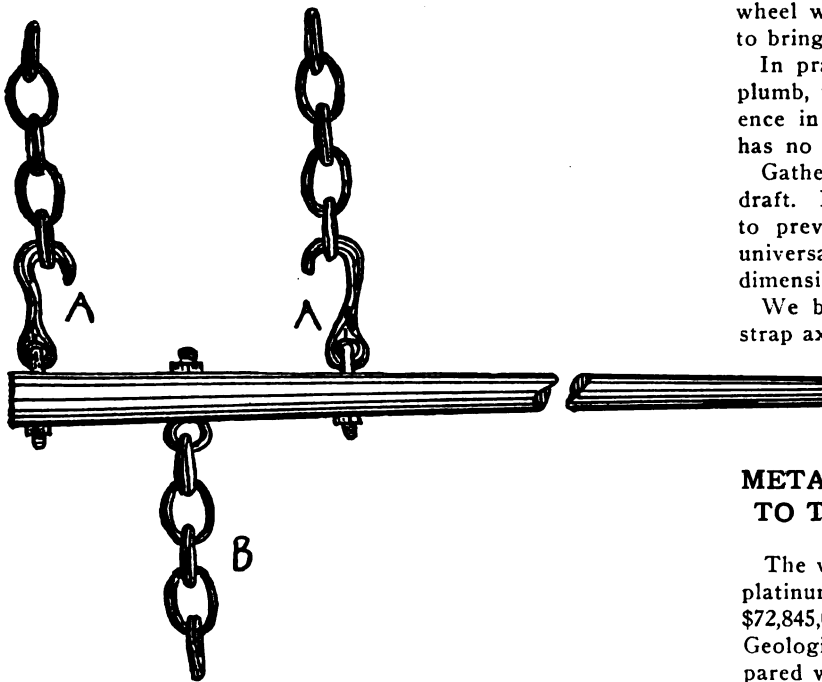

in the eyebolts which are fastened in the pipe, so that when the chain at B is wrapped around the motor or other part to be lifted, and the handle of the pipe alternately lifted and depressed, the hooks can be caught into the succeeding links of the two chains; thus lifting the motor. In lowering the weight the operation is, of course, reversed.

Wood screws when used on an automobile body have a habit of working loose. This is because of the constant jar and vibration of the car. To prevent these screws from working out of place it is a good plan to file through one end of the head below the screwdriver slot. Then, after turning the screw into place tightly, drive a small brad through the filed part into the wood. A nail set will enable you to drive the brad below the surface of the screw head.

The location of a radiator leak is sometimes very difficult, because of the tendency of the water to flow over the surface of the metal tubes of the radiator. This is especially true if the leak is small, as the water will ooze out rather than spurt. To find a leak of this nature, blow smoke into the emptied radiator. This will quickly show where the leak is. To blow smoke into the radiator, take a well-lighted pipe, blow through the bowl of it and connect it to the radiator opening.

ABOUT AXLES

There is a scientific reason for everything done on a vehicle. We will consider the wood hub and staggered spoke wheel. It is evident that the maximum carrying strength of a spoke is when it is perpendicular—hence the plumb spoke. Spokes are tapered from the back, and the outer spoke carries most of the load. It therefore follows that the outside face of the outer spoke is the plumb line. The tread should be at an exact right angle to the plumb line of the spoke, which insures a level bearing of the tire. If the axles are set to a plumb spoke, the difference in height or dish of wheels does not change the length of axles, but the pitch of the arms differs. Where the dish is the same, the difference in height does not matter. The wheel with greater dish must have more underset to the axle to bring equal track measure.

In practice we set the axle on light vehicles slightly under plumb, to allow for the spring of axle under load. The difference in measurement at the top of the wheels, called swing, has no importance.

Gather of axles is wholly wrong in theory, as it increases the draft. In practice we gather just a trifle, say $\frac{1}{4}$ inch over all, to prevent nuts getting loose. Gathering axles was almost universally done 40 years ago, and the rule was to gather a dimension equal to the width of the tire.

We believe the practice had its origin in the early days of strap axles and linch pins and loose fitting rings or boxes. The pins were sometimes lost, but if there was considerable gather in the axle, the wheel running to the collar would lessen the probability of accident.

METAL RECOVERED FROM WASTE AND SCRAP TO THE VALUE OF NEARLY \$73,000,000 IN 1913

The value of the "secondary metals," exclusive of gold, silver, platinum and iron, recovered in the United States in 1913, was \$72,845,000, according to J. P. Dunlop, of the United States Geological Survey. Even this large figure is a decrease compared with 1912, when the value was \$77,396,000.

"Secondary metals" are those recovered from scrap metal, sweepings, skimmings, drosses, etc., and are so called to distinguish them from the metals derived from ore, which are termed "primary metals." The distinction does not imply that secondary metals are of inferior quality. The reports to the Survey do not include the very large quantity of old iron and steel remelted, neither do they include the precious metals. In fact, while the data given in this statement cover a large field and form an essential addition to the reports on primary metals, the scope of the inquiry made by the Survey reveals only in a partial way the vast extent of the waste trade industry, which yearly becomes greater and better organized.

THE TUNING FORK AND SPRINGS

The engineer of an automobile shop has discovered that by applying the laws governing the action of a tuning fork to springs they could oblige one portion of one set of members of springs to neutralize the force of the other, and not only absorb the maximum possible amount of road hammering of the car, but also compel the two sets of springs to come to rest equally and quickly.

Thus, when the car goes over a bumpy road, the lower leaves

of the springs have the same violent blow imparted to them that all other motor car springs receive, but instead of the upper leaves responding in sympathy with them at equal periodicity of vibration in the same direction, they respond at an equal periodicity of oscillations in exactly the opposite direction. The resultant effect is, therefore, zero theoretically, but the practical result is comparatively few oscillations, which are so much less than in the ordinary elliptic spring that the combined effect of tires, with luxurious upholstery, serve to all the extent that can be expected of tires and upholstery alone, to give a degree of comfort that is pleasant to anyone who has never ridden in a car with springs designed to produce the results.

GUARD FOR THE SLIDING JAW OF A VISE

There is no member of the bench vise more abused by the careless workman than the screw of the sliding-jaw part. It affords a ready but costly means of cutting wire and other small stuff with a hammer, to the destruction of this part of

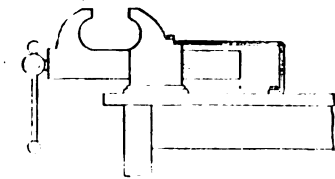

the vise and its roughing so that it will not pass freely through the slot in the guide-jaw head.

The sketch shows a guard strip securely bolted to the bench over this portion of the vise, to afford a permanent and lasting protection for it.

CURVED FILES

Considerable filing has to be done in making up the sheet metal for bodies, such as in cleaning up the joints which have been brazed, and curved files have been found to give the best results. The latest file brought out to meet this demand consists of a curved base, upon which a file blade is mounted, made of steel which will withstand bending in a cold state. When the file wears out, it is easily removed, and a new one may be mounted in its place.

OIL-CUSHION INSERT LUBRICATES SPRINGS

A perforated strip of special antifriction metal, designed to be placed between the leaves of automobile springs, is now being placed on the market, which holds the lubricant in place

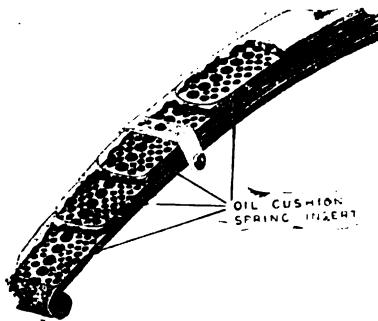

and prevents squeaking and rusting. The oil-cushion insert is a steel alloy, the perforations being filled with a special heavy grease, having a tendency to stay in the holes. After the perforated strips have been placed between the leaves and the spring drawn together by the bolts and clips, the pockets in the cushions are sealed.

BOB POSTE REWARDED

The Columbus Bolt Works and J. R. Poste are to be congratulated in the promotion of genial "Bob" to the important position of general manager of that well known institution in the carriage trade. The Columbus Bolt Works, Columbus, O. Bob Poste and Columbus bolts have been associated together so long that the mind of the carriage men fail to recall when not. It surely seems a fitting recognition of a long valued association, to reward it with an elevation of this degree.



J. R. POSTE
General Manager Columbus (O.) Bolt Works

Bob began at the bottom with this concern, starting in the shipping department and gradually, by earnest efforts and conscientious service, it is pleasing to note, is rewarded with this well deserved boost. And the same consistent, painstaking and enthusiastic devotion to the firm's interest that has characterized his relations to the business in the past, will continue ever more so, if such a thing is possible. The Hub bunch joins with all who know him in wishing that the coming years will continue to bestow on him continued joy, happiness and prosperity and that The Columbus Bolt Works will enjoy progress and good fortune in due and deserved fashion.

TO REDUCE INCHES TO DECIMALS

Fraction of an Inch.	Decimals of an Inch.	Centimetres.	Decimals of a Metre.
1/16	.0625	.15875	.0015875
1/8	.125	.3175	.003175
3/16	.1875	.4762	.004762
1/4	.25	.635	.00635
5/16	.3125	.7937	.007937
3/8	.375	.9525	.009525
7/16	.4375	1.1112	.011112
1/2	.5	1.27	.0127
9/16	.5625	1.428	.01428
5/8	.625	1.587	.01587
11/16	.6875	1.746	.01746
3/4	.75	1.905	.01905
13/16	.8125	2.063	.02063
7/8	.875	2.222	.02222
15/16	.9375	2.381	.02381

Kerosene is a good tempering medium for small tools.

Wood-Working Shop

CLEAVAGE OF WOOD

Wood plits naturally along two normal planes, the most readily along the radius, because the arrangement of fibers and pith rays is radial, and next along the tangent, or with the annual rings, because the softer spring wood forms continuous planes in this direction. Cleavage along the radius, however, is from 50 to 100 per cent. easier, and only in case of cross grain, etc., the cleavage along the ring becomes the easier. In the wood of conifers, wood fibers and pith rays are very regular, the former in perfect radial series or rows, and cleavage is, therefore, very easy in this direction. The same is brought about in the oak by the very high pith rays, but where they are thick and low, as in sycamore, and generally in the butt cuts, and about knots, they impede cleavage, by causing a greater irregularity in the course of the wood fibers. The greater the contrast of spring and summer wood, the easier the cleavage tangentially, or in the direction of the rings. This is especially marked in conifers and also in woods like oak, ash and elm, where the spring wood appears as a continuous series of large pores. Very slow growth influences tangential cleavage, narrow-ringed oak breaks out and splits less regularly, even in a radial direction; in conifers, however, this difference scarcely exists. Weight of wood affects the cleavage but little; in heavy wood the entrance of the ax, to be sure, is resisted with more force, but the greater elasticity of the wood, on the other hand, counterbalances this resistance. Irregularities in the course of the fibers, whether spiral growth, crossgrain, or in form of knots, all aid in resisting cleavage. Knotty bolts are split more easily from the upper end, since the cleft then runs around the knots. Moisture softens the wood and reduces lateral adhesion, and, therefore, wood splits more easily when green than when dry.

Pine is brittle, hickory is flexible; the former breaks, the latter bends. Being the opposite of stiffness, want of stiffness would seem to indicate flexibility. This, however, is only partly true; hickory and ash are stiff and yet among the most flexible of woods. Their small dimensions cause shavings and thin strands of most woods to appear pliable. For this reason the pliable, twisted wicker willow is not a fair measure of the flexibility of the wood of this species. Generally, hard woods are more flexible than conifers, wood of the butt surpassing in this respect that of the main part of the stem, the latter being usually superior to that of the limbs. Moisture softens wood and thereby increases its flexibility. Knots and crossgrain diminish flexibility, but the irregular structure of elm, ash, etc. (particularly the arrangement of bodies of extremely firm fibers, like so many strands, among the softer tissue, as well as the interlacement of fibers, due to post-cambial growth), favorably influences the flexibility of these woods.

FRENCH DEPARTURES IN BODYWORK

The double problem of placing the chauffeur where he is least in the way and of abolishing the unsightly hood when not required has been solved in the latest touring car body by Kellner, of Paris. At the rear of the car is a small platform or deck, within which is a folding seat entirely hidden from view when not required. The seat occupies the central portion of the platform, and to left and right of it are tool lockers with admittance to them through lids in the deck. This general arrangement of placing the chauffeur and his tools at the rear tends toward tidiness on the car.

When not in use, the hood is folded up and carried in a shallow locker at the back of the front seats, the top of this locker forming a table the full width of the car for the convenience of the rear passengers. There are no hoops for the top. At the rear there are two steel uprights, hinged at their base so as to be capable of being folded along the back of the car when the hood is not in use. With these supports raised, they form the rear attachment for the top of the hood, the front attachment being along the top of the windscreen. The top can be stretched taut, and is stiffened at the front, the center and the rear. A back piece is fitted, and the sides are enclosed by two big curtains with oblong mica windows on each side, thus completely enclosing the seats. The gasoline tank being mounted in the scuttle dash, a trunk is carried on rails under the front seat. The side lamps are a part of the body and not an additional attachment. They really form a small cowl on the top of the scuttle, the electric light bulbs being inside this cowl and protected by a hinged glass door.

HOW TO UTILIZE DISEASE-KILLED CHESTNUT

How chestnut timber that has been killed by the bark disease can be utilized to bring the most profit is told by the Department of Agriculture in a bulletin just issued for the benefit of farmers and other timberland owners in the states where the blight has appeared. Most of the chestnut timber north of the Potomac River has been attacked and much of it killed by the disease, which is now spreading to Virginia and West Virginia.

Sound wood from dead chestnut trees, says the department, is fully as strong as wood from healthy trees, and is suitable for poles, ties, slack cooperage, mine timbers, tannin extract wood, shingles, fence posts, and rails, piles, veneer, and fuel. It cannot be used profitably for tight cooperage, for wood distillation, or for excelsior.

Disease-killed chestnut does not begin to deteriorate until two years after death, and in most cases it has been found that trees up to 10 inches in diameter can be sawed into merchantable products after they have been dead four years, trees from 10 to 18 inches in diameter after they have been dead five years, while trees above 18 inches in diameter are merchantable six years after death.

FIRE FIGHTING TO SAVE TIMBER

State and federal forest officers will make a special effort this year to get even more value out of the service of rural carriers in reporting forest fires. The usual procedure has been for the state fire wardens or federal forest officers to send to the postmasters lists of local wardens and patrolmen, with their addresses and telephone numbers. These lists are given to the carriers with instructions to report forest fires to men whose names appear thereon, or to other responsible persons. This year a special effort will be made to follow up the sending out of the lists by having the patrolmen and wardens meet the carriers personally and to take the initiative in arranging such meetings, and also to map out a plan of action to be followed.

DIFFERENCES IN HEAVY WORK TOPS

Tops of cabriolet character cannot all be set alike because the bodies differ in shape and size. In bodies with shallow side quarters the head room never exceeds 3 feet 9 inches, while

those with very deep side quarters, 3 feet 11 inches is given; otherwise the top looks too shallow. The drop, front and back, depends on the fashion and style of body.

FOREST NOTES

The tenth successive year without a forest fire has just been passed by the Powell national forest in south central Utah.

Yellow poplar, or tulip tree, the largest broadleaf tree in America, has been known to reach nearly 200 feet in height and 10 feet in diameter.

Pennsylvania has about 7½ million acres of timberland, one-eighth of which is owned by the state. The total value of the state's timber is 139 million dollars.

TEXAS WAGON FACTORY CHANGES HANDS

J. W. Mitchell and associates have purchased the plant of the Fort Worth (Tex.) wagon factory for a consideration of \$60,200. The factory will be enlarged considerably and will be equipped with facilities for the making of a higher grade wagon than heretofore turned out by the company.

The new company has been organized as the Fort Worth Wagon Mfg. Co., with a capital stock of \$150,000. The incorporators are: Marion Sanson, C. Hightower, John F. Shelton and J. W. Mitchell.

CHANGE IN PITTSBURGH FIRM

C. West & Co., who, since 1875, have carried on the business of vehicle building at 418-422 Duquesne Way, Pittsburgh, Pa., announce that they will discontinue the business about June 1. Louis F. and Fred. H. Eversmann, who have been with this firm many years, will continue the business with practically the same organization, under the name of The West Company. The new firm has secured a location at 4017-4031 Liberty avenue, at Fisk street, in every way adapted to the business.

PROVED ITS SOLVENCY

The Williams Wagon Works, of Macon, Ga., was the winner on April 21 in its petition brought in the United States district court before Judge Shepherd to have an involuntary petition in bankruptcy brought by one creditor, dismissed.

The company contended that there were less than twelve creditors in all and that the involuntary petition was brought by only one of them. The Williams company set up that the pendency of the petition was injurious to its business and should be dismissed.

Judge Shepherd signed an order to that effect.

RECEIVER FOR BODY COMPANY

A petition in bankruptcy has been filed in the Federal court in New York City against Burr & Co., West 75th street and Amsterdam avenue; the company is a body builder and its liabilities are estimated at \$102,000, with assets in the neighborhood of \$25,000. The business was started in 1892 by the firm of Burr & Co., and was incorporated in December, 1903, with capital stock of \$100,000. Richard O. Burr is president and William J. Moran secretary.

RETIRES AFTER FORTY-FIVE YEARS

Samuel Armstrong, for 45 years connected with the Mitchell & Lewis Co., Ltd., and the Mitchell-Lewis Motor Co., Racine, Wis., a large proportion of the time in the capacity of superintendent, has retired and will spend his remaining days in Pasadena, Cal. Prior to his departure, Mr. Armstrong received a set of resolutions expressing the esteem in which he was held by the officers and employees of the Mitchell-Lewis Motor Co.

TUCKER WOOD WORK CO. MAKING STEERING WHEELS

The Tucker Wood Work Co., of Sidney, O., well known to the carriage trade, are now making a specialty of steering wheels for automobiles. The rims are made of solid bent wood and the spiders of aluminum, brass, malleable iron or pressed steel. The woods used in the bent rims are white maple, mahogany and black walnut, and the ends are joined by a dovetail joint that is guaranteed to be as strong as the rest of the rim. The Tucker company will build up wheels of wood that cannot be bent, but strongly recommend the bent style for strength and durability. The standard finish is of a composition called Ferronite and the claim is made that it is absolutely waterproof, will not chip or flake off and will wear for a very long time. Maple wheels can be finished to resemble black walnut or mahogany so closely that detection is difficult. Rims are made in all sections, plain or corrugated, and in any quantity. An interesting feature of the Tucker wheel is the method of attaching the spider arms to the rim. Slots are cut in the rim and notches are cut entering the slots. The arms are dropped into the notches, partly rotated to bring them into the slots, and the notches filled.

NONES SEEKS CONTROL OF KENTUCKY WAGON WORKS

Indications of a contest for control of the Kentucky Wagon Mfg. Co., at Louisville, were noticed in a card addressed to the stockholders of the company on May 8. Mr. Nones asks the shareholders not to execute their proxies authorizing anyone to vote for them at the annual meeting, May 27, until they know "the facts about the affairs of the company."

Mr. Nones was succeeded as president of the company about the middle of last year by R. V. Board, who went to Louisville from the New England branch of the International Harvester Co. When the change was made Mr. Nones was elected chairman of the board of directors, and continued on the pay-roll. However, according to a director, Mr. Nones' contract with the company expires at the end of May, and his salary, amounting to \$7,000 or \$8,000 a year, will stop. Mr. Nones' son, Seth M. Nones, who was vice-president and general manager of the company, tendered his resignation and left the concern two or three months ago.

OWENSBORO WAGON COMPANY VERY BUSY

The Owensboro (Ky.) Wagon Co. has spread out into new territory and has made heavy sales in established agencies. The company recently received a contract for ten car loads of the company's wagons for shipment to Idaho; and a big shipment of eight-wheel log wagons is under contract to be sent to Honduras. The company is making a specialty of foreign trade for big log wagons. Eight carloads of log wagons were recently shipped to Africa.

Although April is ordinarily a slow month, the company has been kept running at almost regular time. Between 300 and 350 skilled mechanics are under employment by the company and orders for future shipment will run incessantly with but little rest for inventory into mid-summer.

AN ELECTRIC ON FORD PLAN

Edsel Ford, vice-president of the Ford Motor Co., and son of Henry Ford, will head the new company in Detroit for the manufacture of a light-weight, low-priced electric automobile. This new car is being designed to take a battery which is now being developed by Thomas A. Edison. It is expected that these cars will be ready for the market some time during the present year. They will be manufactured in Detroit and will sell for about \$600.

Trimming Shop

TOP MATERIAL

The proper manipulation of various materials employed in the construction of covering for tops, either movable or stationary, is a knowledge only acquired by actual experience. We do not speak of inside covering, such as head lining, but the outside covering only. Commencing with the most expensive, we have the leathers known as landau, cabriolet and ordinary pebble grain or buggy top leather. These leathers are hand buffed, and consequently the most costly, and are used especially on fine body work, the leather of which comes in various weights. Next comes machine-buffed leather and imitation leather. Finally, we are brought to the gum top, which is the cheapest material in use for tops. The canvas or drill materials are seldom, if ever, used for heavy work. All these materials have laudable features. The hand-buffed leathers have, of course, the first place, by reason of their durability and better appearance, and are naturally more expensive. Because of their high cost, machine-buffed leathers are frequently substituted, which partly resemble the higher priced goods. Durability is wanting in them. One of the differences in the machine-buffed leather is its susceptibility to shrinkage when exposed to the elements, as tops of all kinds are more or less exposed to weather.

The next grade of tops are made either of duck canvas or gum drill, and the "imitation" leather, which are the cheapest of top materials. From such material we cannot expect the beauty nor the durability which belong to better and more expensive materials. The fault of duck canvas is the liability to crack, while the defect of gum is its tendency to become dull and turning from its original color. Although a falling top made of gum drill is one which gives more wear, compared to the cost, than any other material for falling tops, it is perhaps more desirable than either duck or the cheaper grades of machine-buffed leather, because it won't crack and don't shrink like cheap leather.

TRIMMING FOR A STICK SEAT

There is no construction for light work quite so pleasing in appearance as a body with stick or spindle seat.

Now that the trade is strongly inclined to the uncouth automobile seat imitations, it is a pleasure to recall a good and sensible seat, and a manner of trimming it.

The seat has a solid back piece resting on seat rail. The back is made up with springs, as follows: Fit a piece of cardboard to extend from the cushion top to a point about 2 inches above the bottom of the upper back, paste a narrow piece of drill to the cardboard along the bottom to stitch through; this will prevent the machine cutting the edge. In fitting the bottom edge of the cardboard, it should conform to the sweep of the cushion.

The foundation for the back, which is one of buckram on to one of drill, is fitted to exactly conform to the cardboard below the panel, and for the panel it is left flush enough to extend over the springs and tack to the edge of the panel. The back has one row of 4-inch springs; they are covered with two thicknesses of cotton muslin or burlap, and are not bridled at all, but sewed to the burlap. Now lay out the back foundation; also the goods, giving $\frac{3}{8}$ -inch fullness for the points up and down and $\frac{1}{4}$ inch for the pipes, and line the goods with one of wadding. Plait the goods along the bottom and up the sides to the upper back, securing with tacks. Sew across the

bottom on the machine, stitching on a piece of goods wide enough to cover the back of the cardboard; this is brought around and tacked along the upper edge of the cardboard; the ends of the back below the upper back must be bound. Tack the back foundation to a frame and squab it. The back is now placed and held in position, and the cardboard is tacked to the lower edge of the upper back; the springs are put in, the foundation tacked in, and close up the back, which is also squabbed.

After obtaining the outline of bottom and partition, lay off the partition and get out the cushion top, giving $\frac{3}{4}$ -inch fullness sidewise and $\frac{3}{8}$ inch back and front for the points; the pipes have no fullness; give $\frac{1}{2}$ inch around the edge besides the seam.

The top is lined with wadding, is plaited up on the machine, and left open at the back and squabbed; the plaits through the center, all excepting around the edge, are sewed out.

The front facing is cut 3 inches wide, including seams, being about 1 inch higher for springs. The springs are made up as follows: Get out a $\frac{3}{8}$ -inch round iron frame, the right size to fit half way up from the bottom to the partition. The springs, which are 4-inch, No. 11, are tied into the frame, but are not bridled down any; the springs are covered with duck canvas. The front is built up with a soft cotton roll, or it may be stuffed with hair, the wadding, however, is preferable; it is kept in place by sewing a strip of burlap. The fall has a raiser all around, the center being raised up with one sheet of wadding.

The front facing has a plain raiser. In putting in the spring frame, place two sheets of wadding at the bottom and one at the top, to prevent the springs from wearing through.

The bottom is sewed in across the front and 2 or 3 inches back; after the springs are in position, the bottom is blind sewed in by hand, filling in the space above and below the iron frame with hair.

PASTE

Paste is to the trimmer what glue is to the woodworker. If paste is poor, work is not good; if the woodworker has bad glue his work cannot stand the strain it has to bear.

Trimmers have their own idea of how paste should be made. Some differ as regards ingredients to be used in making paste, but all agree that paste should be made of either wheat or rye flour. Rye flour seems to yield finer qualities for paste than the wheat flour, it works up thinner and dries much more firmly than wheat paste.

The following mixing may be counted on to give satisfactory results: Take 1 pound of rye flour, mashing the lumps well with the fingers, then add water enough to mix it to a thick dough, then knead with the paddle until all of the small lumps disappear, then add water enough to reduce it to nearly the stiffness desired when the batter has been boiled; add to the batter 1 gill of turpentine—if the weather is warm add a larger quantity of the turpentine; stir the turpentine through the batter (the batter at this stage will seem lumpy, but it will cook all right); place the vessel over a hot fire and boil the paste for fifteen minutes, constantly stirring it; after it has boiled sufficiently take it off the fire, but keep the stirring up until all the steam has been worked out of it. When the paste first comes off the fire it will seem thin and lumpy, but as the steam disappears it will thicken and become smooth. It may be that the first trial will not be thick enough, but this can be remedied in the next making.

This paste is proof against all insects. Flies will not trouble

it, rats and mice turn away at the smell of it, and moths will not breed where it is used, and it will keep any length of time without spoiling.

PATENT LEATHER

There was formerly secrecy connected with the making of this article, and the working recipes were made up of many mysterious ingredients, some of which do not appear to have been essential to the mixture in any way. With the gradual passing away of what were trade secrets a better knowledge of how the different bodies behaved was obtained, and today the principles of preparing a varnished leather are fairly well known to all concerned in the leather trade. Of course, the chief difficulty was the production of a highly-glazed film which was both flexible and not liable to crack, and one also which adhered closely to the leather without any danger of peeling away. This latter fault is only avoided by seeing that the grain of the leather is first carefully prepared to receive the varnish, and too much attention cannot be given to this part of the work. The body which formerly was the main basis in making patent leather was boiled linseed, or drying oil, which possessed the property of absorbing oxygen from the air and hardening into a tough, flexible skin. The coloring matter necessary for the finished leather could also be carried in the oil. The oil required prolonged boiling before taking on the property of hardening, and this operation, which was done at a temperature of 500 degs. F., required the most watchful care owing to the danger of its firing. As the boiling proceeds the oil grows more viscid, and, if kept up, would be completely changed into an elastic, rubber-like mass. Owing to linseed oil possessing this property in a high degree, it has figured as the chief ingredient in hosts of mixtures for making artificial rubber, and this quality of drying to a flexible film is exactly what is required in the making of patent leather. At all times the boiling of oil is a dangerous operation, as it is liable to froth up and run over the pan in no time; this is particularly so with a drying oil, which thickens as the boiling proceeds, so that the operation should be conducted out of doors or in a place where there is no danger of fire. Raw linseed oil is taken to start with, and this is boiled for about six hours with about 3 ozs. of finely ground litharge to the gallon, along with $\frac{1}{2}$ oz. of borate of manganese. The finely ground coloring matter is also added at the same time, which for black is made up of Prussian blue, brown ochre, and vegetable black, while for colored varnishes chrome yellows and greens are used, or any of the mineral body colors which are used for paint making. All the ingredients, however, must be perfectly dry, and in as finely a powdered state as possible, as if any of them are in any way damp a perfectly homogeneous varnish is impossible.

Japanning and enameling are practically the same, excepting that the term enamelling is applied to skins which have been varnished and embossed on the grain side, while japanning is a smooth finish. Flesh splits are enamelled, and extensively used in the carriage trade.

LEATHER RENOVATOR

A formula for preparing a leather renovating mixture consists of darkening neatsfoot oil with ivory black, applying this mixture to the leather with a soft cloth and then polishing dry. This serves to preserve the top and to give pliability to the leather. In respect to genuine mohair tops with a rubber interlining, which all double texture mohair fabrics have, the safe and sure treatment consists of a brisk brushing with a stiff broom, or a careful cleaning with castile soap and soft water, the condition of the top suggesting which of the two treatments is most desirable for the case in hand.

In any event, the application of kerosene, gasoline or any petroleum by-product, or any oil of a similar nature, may be

considered very detrimental to the mohair top and destructive to the rubber interlining.

ONE WAY STREET TRAFFIC

St. Louis is giving the "one way" street system a trial. The new regulations were framed by several traffic experts who have made a study of St. Louis' congestion of traffic in the downtown district.

A close observance of conditions showed that Sixth street was one of the busiest downtown lanes, and that the preponderance of traffic on that street moved southward; therefore the street will be made a southbound street. Seventh street will be for northbound vehicles exclusively. These two streets for the present will be the only "one way" lanes; but the alley ways in a district bounded on the north by Washington avenue, on the south by Walnut street, by the Levee on the east, and by Twelfth street on the west—an area of about 30 blocks—will be for traffic in one direction. The north and south alleys will be used for the northern traffic, while in the east and west alleys traffic must move in the westerly direction.

The east side of the court house at Fourth, Market and Chestnut streets will be widened 15 feet, and this square then will be the downtown parking territory, relieving the congestion which usually prevailed on Fourth street from Washington avenue to Walnut street, a stretch of eight blocks.

The one-way system will be in order only from 7 in the morning until the same hour at night.

At Twelfth street and Locust, the busiest intersecting corner in St. Louis, safety lanes have been maintained. Vehicles coming south or north on Twelfth street, the city's widest thoroughfare, use the center of the street, while the vehicles intending to go either east or west on Locust street must hug the curb. A lane is set aside for the pedestrian next to the street car tracks.

Metal signs informing the drivers of the changes in the regulations are posted throughout the downtown district and are sent to stables for the guidance of the drivers.

THE GIFT OF THE FUTURE

Up to the present we have been forced to move in two dimensions by the help of the three beasts of burden and a few live coals in a pot. Now we perceive that we can move in three dimensions and the possibilities of our new freedom distract and disturb us in all our relations. This is because our minds are still hobbled and knee-haltered by inherited memories of what were held to be immutable facts—distance, height and depth, separation, homesickness, the fear of accident and foul weather.

Month by month the earth shrinks actually and, what is more important, in imagination. For the moment, but only for the moment, the new machines are outstripping mankind. We have cut down enormously, we shall cut down inconceivably, the world's conception of time and space, which is the big flywheel of the world's progress. What wonder that the great world-engine which we call civilization should race and heat a little!

Only the spirit of man carries on unaltered and unappeasable. There will arise—they are shaping themselves even now—risks to be met, as cruel as any that Hudson or Scott faced; dreams, as worldwide as those Columbus or Cecil Rhodes dreamed, to be made good or to die for; and decisions to be taken, as splendidly terrible as that which Drake clinched by Magellan or Oates a little farther south. There is no break in the line, no loads are missing. The men of the present have begun the discovery of the new world with the same devoutly careless passion as their predecessors completed the discovery of the old.—Rudyard Kipling.

A toll road 20 miles long and costing \$5,000 to the mile has just been completed in Texas.

THE FUTURE OF THE ELECTRIC VEHICLE

The Central Station is a well-conducted guide to all that is doing in electric central stations. It sees a great future for the electric vehicle through the ability of central stations to have the "juice" always available at usable rates. Following is the way our contemporary dopes it out:

The next decade will witness the gradual rise of the electric vehicle industry to an astounding climax. This will be due to the multifold thousands in use, and the fact that their place for all general purposes will be so strongly established, that it will become the familiar and understood thing to accept them as the natural products of the age. The gasoline car is one involving mechanical, electrical and pneumatic features of marked complexity, though reduced, as far as the final handling is concerned, to a system of levers and buttons. But the underlying complexity is there all the same, and to the layman's mind, impossible to grasp or overcome, except as the result of study, experience, and what would be termed in medical parlance, "pathological diagnosis." This last is an examination after disease is present, in other words, readjustment and repair after a "break down." For this reason, an expert mechanic is needed, as far as pleasure cars are concerned, to completely operate them. Very expensive cars costing many thousands of dollars require a great deal of attention, or engine trouble and spark trouble will develop and interfere with the use of the machine.

An electric vehicle has a natural recommendation of its own, simply because the electric motor develops rotary motion and thus immediately simplifies the organism thus created by its application to a vehicle body. The fact that the power is capable of directly producing rotary motion eliminates at once the necessity for intermediate apparatus to bring this about. Therefore, between the power and the motor is a simple connection; also, between the shaft of the motor and the vehicle body is a comprehensible drive. In other words, from electric power to motive power is found no intervening carbureter, spark plugs and magneto; also, no need exists for the type of speed control due to the peculiar requirements of internal combustion engines, with their varied conditions of operation and management. Simplicity is the overwhelming characteristic of the electric vehicle; battery, motor, and vehicle body constituting the final and only trinity of its organization. It is natural, therefore, that it survive all other types of automobile construction, and finally become the most prominent and most universal type of vehicle to be used for business and recreation by the greater mass of our wage earners.

It is not necessary to consider the two points of view at once in this or any other problem. The first and most natural question, is that relating to the possible extension of the use of electric vehicles. The second and more technical consideration is the effect of this remarkable and expected expansion in the sale and use of electric vehicles upon the business of the average central station in the United States. This is the milk of the cocoanut, as far as central station data is concerned, and while it means a burst of industrial development that will place a car in the hands of thousands still untempted by price or quality, this new regime of electric auto building will open up new avenues to the average home.

There are hundreds of thousands waiting to be reached by an attractive proposition in the shape and character of an electric vehicle. It would be an anomaly to see the settled territories of the east and the west richly equipped with the transmission and distributing lines of central stations, used for lighting, heating and cleansing homes; and then expect to see vehicles operating with a foreign power the masters of the field. If circumstances call for a result, for which all preparation is made, that result must occur, unless some uncalculated, unexpected, and antagonistic element obtrudes. The country is being electrified, north, east, south, and west. Power is being transmitted and distributed hundreds of miles at thou-

sands of volts. Cities are now wholly dependent upon electricity for all their industrial and domestic well-being. It would indeed be strange for the electric vehicle to fail in its final firm and permanent hold on these fields. Price and quality will accomplish this in the next decade, and then the central station will truly come into a large part of its own.

The establishment of charging taps with automatic meters arranged for a given number of kilowatts will become the feature of all broad highways of traffic in cities and between them. It is estimated that about one million families in the United States can now be reached by means of a reliable, moderate priced electric car of reasonable distance capacity. The kilowatt hours they will consume would bring joy to the most frosty hearted of our central station managers. If the last words of one of our greatest auto manufacturers is to be taken seriously, the country will shortly be treated to the sight of the "family electric" at almost everyone's door.

A GOOD VEHICLE RUG

We show an illustration of a rug that is being sold in England that ought to appeal to rug makers hereabout, due to the good feature described.

The weather side is composed of flexible waterproofed cloth, which keeps the wet out, while a soft but durable cloth is used as a lining.

There are three good features in this rug, the first being that the end is lined for about a foot up with the waterproof material, so that it may be washed without any risk of damage. As the end is the portion which usually trails in any mud or



grease that may happen to be about, this is a very important point. Secondly, when the rug is wrapped neatly round, it may be kept in the desired position, even if the driver leaves his seat, for, arranged along the top are a series of hooks to which two strong straps, also attached to the rug, may be fixed. When these are hooked on, the rug will remain in place.

Finally, in order to prevent the water which trickles down the front of the rug from falling on to the driver's feet, a V-shaped piece of material is let into the front. When seated, the effect of this design is that the rug clings closely to the legs and all rain falls to the floor between them.

COMMENTS ON THE AMERICAN MOTOR TRUCK BY A BRITISHER

At least 44 manufacturers have given up the struggle—the truck business has not proved the El Dorado they expected, and among those left are many who have had a narrow escape from the receivers' hands. Naturally, a conservative policy is the order of the day.

The decision of the American Locomotive Co. to discontinue the manufacture of its Alco truck came as a thunderbolt. Notwithstanding the millions of dollars capital behind this company and the fact that they had a reasonably good truck, they believed they were losing more money than the future would return to them, so they retired from the field. In the process they unloaded many hundreds of trucks at a low price on an already overstocked market. This and the failures of others precipitated a serious crisis from which the truck industry is just recovering.

The cruciform-section type steel wheels proved a failure when adopted by one of the leading companies, and wood wheels have replaced these defective members in almost every case. This failure has deterred many from adopting the steel wheel, and has postponed its permanent arrival. There are many rumors that other types of steel wheels are proving unsuccessful in England, even the hollow-spoke box-rim type being subject to breakage after small mileage. The truth of the matter would be of great value. Wheels in this country have to stand up to great climatic changes, bad road surfaces, and high speed. As yet nothing has been found superior to wood.

The tire situation is clearing up. The demand is more and more for demountable types. These, as far as I know, are not used to any great extent in Europe, but really the success obtained in rough service over here would warrant their successful use under less strenuous conditions. Their advantage is that a powerful press is unnecessary for their replacement. A man with a wrench can replace a tire in a very short time. Tire mileages have not changed; about 8,000 miles is still the accepted mileage, though here and there are isolated cases of up to 18,000 miles per tire being reached, doubtless due to the individual attention of the owner or driver.

The Chain Drive Disappearing

The worm drive has advanced by leaps and bounds. Where two manufacturers alone supplied this two years ago, there are now at least 16, and in addition two leading axle manufacturers are supplying a line of worm drive axles which will still further increase the adoption of this form of drive. The engineer of this company stated that where they could give an option on chain drive or worm drive axles, the tendency was to adopt the latter.

There is also an increase in the number of internal gear type axle makers, and a corresponding decrease in the number of chain drive models.

This is to be expected as much as anything else from the state of the labor problem. A driver wants to drive his truck and very little more. Anything extra in the way of cleaning is abhorrent, and if enclosed rear drives give him less work to do, he is favorably inclined toward them. The good will of the driver is always a valuable asset.

The flexible type frame has not made any rapid advance, but has found a few adherents among the newer makers. The use of pressed steel frame members is decidedly on the increase. It is possible to obtain these of a high grade of alloy steel suitably heat treated, obviously distinctly superior to the commercial structural steel on the market.

Standardizing British-type Coolers

The vertical gilled tube radiator with cast top and bottom tanks is evidently going to be the ultimate type, unless some new design is evolved. In an investigation by the Society of Automobile Engineers, it was decided that this latter type would be that on which they would expend their standardizing

energies. This body is seeking to standardize the length, breadth, and width of cores for built-up radiators, so as to minimize jigs, tools, and replace supplies carried by manufacturers.

Few New American Models

Notwithstanding the propaganda advocating the small motor and reduction in speed of the whole truck, there is but little sign of manufacturers taking this up.

Probably this is so because much money has been spent on jigs and tools which must be realized before a new model can be considered, and the year just elapsed has been unpropitious for new models. As the influence of speed in increasing maintenance of vehicle on road is more generally understood, speed will drop.

CASTOR OIL NOT A GOOD LUBRICANT

Some steel balls from bearings, which had developed a curious corrosion effect, were submitted for investigation of the cause. These balls had been immersed in a lubricant containing castor oil. We quote the following:

Preliminary experiments comprised the exposing of a number of balls to the action of various oils, including castor oil, compound and mineral oils, while among other oils were finest pure castor oils, pure mineral oils, various fatty oils, and the fatty acids of various fatty oils, such as lard, olive, etc., it being thought probable that such fatty acids might have a very pronounced effect. The experiments extended over several months at a temperature of approximately 100 deg. Fahr.

These tests point definitely to the conclusion that castor oil and compounds thereof stand alone as being especially energetic in this corrosive action of hardened steel surfaces. For the action of the above-mentioned fatty acids was practically negligible, as was that of the fatty oils themselves, while with pure mineral oil there was no sign of any change.

The castor oil apparently has a selective action on hardened steel surfaces in that it dissolves out only certain of the crystals, and when the skin has thus been penetrated, its action on the underlying softer metal is more uniform, and so the still undissolved portion of the skin becomes detached and breaks away.

FRICITION TRANSMISSION MINUS DISKS

The designing of many cyclecars, both here and abroad, has brought about an increased interest in the friction type of transmission, which possesses many qualities that are of particular value to small, light-weight machines. One of the French cars in which friction gear is used is the Delacour, in which, however, the more or less conventional arrangement of disks is shunned.

The Delacour transmission consists of a cone and a wheel, changes of speed being obtained by bringing the edge of the wheel in contact with the surface of the cone at various points. While the length of the cone is such that somewhat more space is occupied than is the case with the disk arrangement, it is claimed that the running contact is better than with the disks, because there is no sliding motion between the driving member and the driven member.

With a wheel with its edge in contact with a disk there is a point at which the speeds of the two members agree exactly; if that point is at the center of the wheel edge, there is sliding contact and friction on either side. In the case of the cone and wheel the surfaces in contact travel at exactly the same speeds at all points. Whether or not the theoretical advantage is a practical advantage as well, and whether or not there are disadvantages that balance the advantages, the application is an interesting one.

A good bronze paint for iron is made by grinding together 2 lbs. chrome green, 1 oz. ivory black, 1 oz. chrome yellow, and 1 gill of good japan. Thin with raw linseed oil.

NEW COLUMBUS BUGGY CO. SOLD TO THOMAS CAR CO.

The New Columbus Buggy Co., which in January last was incorporated with \$500,000 capital and took over the Columbus Buggy Co., Columbus, O., was sold in entirety to C. A. Finnegan and E. D. Hofeller, both of Buffalo, N. Y. Finnegan is the man who about a year ago took over the defunct E. R. Thomas Motor Car Co., and this fact has led to something more than a rumor that the Thomas company will be removed to Columbus and consolidated with the buggy company. Finnegan, in fact, is authority for the statement that "It is very likely that we will move the E. R. Thomas company and operate it at the Columbus plant."

Although the price paid for the Columbus company has not been divulged it is understood that it was a comparatively large one. By the contract of sale the new owners will take over all of the capital stock of the buggy company. They plan not only to continue the plant in operation but largely to increase its output.

At the time the New Columbus Buggy Co. was organized G. W. Lattimer, a wholesale druggist and one of the two men who had been directing the operation of the factory, was elected president. The other officers elected were E. R. Sharp, vice-president; D. N. Postlewaite, secretary; G. W. Bright, treasurer. These officers and O. A. Miller, F. O. Schoedinger, Robert Jeffery and T. J. Cavanaugh comprised the board of directors.

KNOX CO. AT A BARGAIN

Referee Charles W. Bostwick approved the sale of the Knox Automobile Co., Springfield, Mass., to Edward O. Sutton but not for the amount of his original bid, which was \$350,000.

The acceptance by the referee was in the face of a strenuous protest from an attorney representing creditors who, among other things, claimed that "the proceedings under which the sale was authorized were invalid, that the order of the referee in bankruptcy was invalid, that the trustee in bankruptcy has no title to the property" and that the "necessity for selling all of the property does not exist."

Subsequent to the rejection of his first bid, and as a result of the pressure which was brought to bear upon Sutton by interests closely connected with the Mayo estate, which he represents, Sutton increased his bid to \$631,090, for which figure the plant was struck down to him. He has announced his intention of continuing the manufacture of cars as at present.

IMP ADDS FOUR-CYLINDER MODEL

The Imp Cyclecar, which is produced by the company of that name in Auburn, Ind., is about to take unto itself a larger brother. President W. H. McIntyre has announced that the new Imp will have a four-cylinder water-jacketed motor, rated at 10 horsepower, and will be ready for June deliveries. The new car, like its predecessor, has a 36-inch tread; the wheelbase of the new model will be 100 inches, and it will be equipped with 28 x 2½-inch tires, engine starter, a gearless differential, double universal joints and a shaft drive to friction transmission under the rear seat with single chain drive to the rear axle; double front springs will be used, the rear springs being cantilever members; two passengers will be carried—one before the other; the vehicle will weigh 750 pounds, and will sell, completely equipped, for \$395.

WINONA SELLING CHANGE

An important change in selling arrangements in certain northwest territory has been announced by the Winona (Minn.) Wagon Co. The company has entered into a contract with the Northern Rock Island Plow Co., of Minneapolis, under the

terms of which the complete line of Winona wagons will be handled at wholesale by the Minneapolis concern in North Dakota, eastern Montana and northern Minnesota. The Winona line has been sold in the sections named by the company's own traveling salesmen for more than 30 years and has a strong hold on the trade.

DRAFT TEST

A draft test was made at the plant of the James & Graham Wagon Co., Memphis, Tenn., on May 8, under the auspices of the farm wagon department of the National Implement and Vehicle Association, the object of which was to determine the effect upon draft of various heights of wheels and widths of tires.

The U. S. Department of Agriculture was represented by Mr. McCormick, of the good roads section. There were also present E. W. McCullough, secretary and general manager of the National Implement and Vehicle Association, representatives of the Studebaker Corporation, Deere & Co., and the International Harvester Co.; also a number of agricultural engineers connected with state colleges. A complete report of the tests will be issued as soon as possible.

TWIN CITY A SIDE-BY-SIDE CAR

The Twin City cyclecar, announced by C. H. Scholer, of Minneapolis, is a side-by-side car on 36-inch tread and driven by a four-cylinder air-cooled piston valve motor.

This car has just completed tests and has shown good performance over several hundred miles of running. The drive is by shaft, friction and chain, the friction layout being at the rear of the seats, a short chain connecting to a solid axle.

PRIGG CO. TO MAKE CYCLE CARS

Indiana, which is now one of the principal cyclecar manufacturing centers in the United States, is to have still another cyclecar factory. This is to be established at Anderson by the newly-organized H. Paul Prigg Co., which has an authorized capitalization of \$100,000.

NEW CAR WITH KEROSENE CARBURETER

Cleveland capital, associated with Francois Richard, a French engineer, is to produce one of the first American cars with kerosene carbureter as standard equipment. Not only the carbureters but the motors, too, are especially built to use the cheaper fuel. The Richard Automobile Mfg. Co. has been incorporated with \$250,000 capital.

PALMER SENTENCED TO PRISON

Victor L. Palmer, of Kalamazoo, formerly secretary and treasurer of the defunct Michigan Buggy Co., convicted of using the mails to defraud, was sentenced April 24 to two years at hard labor in the federal penitentiary at Leavenworth, Kas.

TROUBLE FOR TRAILERS

The Grinnel Vehicle Co., of Grinnell, Ia., has filed a petition in bankruptcy. This concern has made a business of trailing vehicles. Its assets are placed at \$24,229 and liabilities \$36,615. Individual petitions have also been filed by Chas. Hodgdon and M. C. Parish, partners in the concern.

TRUTH OVER THE DOOR

Over a gate leading to a hotel entrance at a Long Island town are the words:

"Entrance for Automobiles and Vehicles."

KENTUCKY WAGON CO. SALESMEN

President R. B. Board, of the Kentucky Wagon Mfg. Co., is making quite a number of changes in the sales staff of the organization. J. P. Alexander, formerly of Tennessee, will take the Texas territory. B. B. Breed, who until recently was with the Studebaker Company, will go to Kansas, and F. C. Lee, who formerly worked Missouri, out of Springfield, for the Studebaker people, will be sent to Oklahoma City, to look after Oklahoma business. Business is fairly good at present and collections are coming in well.

"SERVICE AND EFFICIENCY"

C. M. Barnett, traveling representative of the Hercules Buggy Co., of Evansville, Ind., in southern Illinois and southern Missouri, has opened a supply house at Mt. Vernon, Ill. This establishment is being operated for the convenience of customers in Mr. Barnett's territory, so that they can be supplied with quick shipments on "fill in" orders.

SPOKE MANUFACTURERS MEET

The annual conference of the National Spoke Manufacturers' Association was held at Hotel Jefferson, St. Louis, May 7.

L. B. Pennoch, of Nashville, Tenn., president of the association, said the Interstate Commerce Commission had been asked to revise freight rates in the central states. He said the rates are unfair in the territory adjacent to Fayetteville, Ark.

THIRD MICHIGAN BUGGY CO. DIVIDEND

The third 5 per cent. dividend was mailed to creditors of the Michigan Buggy Co. by the Detroit Trust Co., trustees in bankruptcy, the last of April. This makes a total of 15 per cent. which has been paid. Another and final 5 per cent. disbursement will be made later, so that the creditors will have received an aggregate of 20 per cent.

STUDEBAKER'S NEW SECRETARY

At the annual meeting of the Studebaker Corporation, held in New York, April 8, the old members of the board of directors were reelected. A. G. Rumpf has been elected secretary to succeed Scott Brown, who resigned to engage in the practice of law.

DANIELS RESIGNS FROM OAKLAND

George E. Daniels, who for the past four years has been vice-president and general manager of the Oakland Motor Car Co., Pontiac, Mich., has handed in his resignation and severed his connection with the company. The duties of general manager hereafter will be performed by President C. W. Nash, of the General Motors Co.

LIGGETT PLANTS CONSOLIDATED

The Liggett Spring and Axle Co. has discontinued its Pittsburgh office and moved its entire Cleveland plant to Monongahela, Pa., thus concentrating all departments, executive and mechanical, for greater efficiency. On March 1, H. R. McMahon resigned from the company and J. H. Neuhart has been elected general manager.

NEW OFFICER FOR TURNBULL WAGON WORKS

A. J. Holt, of Moline, Ill., formerly with the John Deere Plow Co., has entered upon his new duties as secretary and treasurer of the Turnbull Wagon Works at Defiance, O.

DIMENSIONS OF AUTOMOBILE R. R. CARS

The automobile cars constructed previous to 1910 were of one of the 36-foot class, chiefly for the reason that the 36-foot length had long before been adopted as the standard length for box cars; a standard being highly desirable to facilitate spotting in freight and transfer sheds. The 40-foot car, which term includes lengths from 39 feet to 40 feet 6 inches, was early recognized as a suitable length for economical shipment of automobiles, as two largest size automobiles can readily be placed therein, but the great advantage is that three of the medium-sized popular-priced automobiles can be accommodated in a 40-foot car, but not in a 36-foot car.

CHANGED POSITIONS

George May, who has been connected with the Owensboro Buggy Co. for several years, has secured a position with the Delker Bros. Co. Mr. May will be foreman of the gear department.

C. COWLES & CO. TO ENLARGE

C. Cowles & Co., New Haven, Conn., are arranging for an addition to their factory, which will give them virtually half again as much room as they now have in their main building. Work on the addition will be begun at an early date.

BODY BUILDERS ADD TO PLANT

In order to permit an increase in production to 150 bodies a day, the Hayes Ionia Body Co., Ionia, Mich., has started construction on an addition to its factory. It will cost \$20,000. It is expected that it will be ready June 15.

CARRIAGE MAN A BENEDICT

David Rathburn, for the past 14 years connected with the Harper Buggy Works in Columbia City, Ind., stole a march on his friends April 11 when he quietly slipped over to Elkhart and was married to Miss Della Christner.

NEW CHICAGO LOCATION FOR SHELDON

The Sheldon Axle Co., of Wilkes-Barre, Pa., on May 1 removed its Chicago office from 68 East 12th street to the People's Gas Building at the corner of Michigan boulevard and Adams street.

NEW MANAGER FOR EDGERTON WAGON CO.

W. W. Huxtable has withdrawn as manager of the Edgerton (Wis.) Wagon Co., and Bart Curran has been appointed to that position. Mr. and Mrs. Huxtable will move to Mason City, Ia.

PUBLISHER'S STATEMENT

Statement of the ownership, management, etc., of The Hub, published monthly at New York, N. Y., as required by the Act of August 24, 1912.

Editor, C. H. E. Redding, 24 Murray St., New York City.
Managing Editor, none.
Business Manager, G. A. Tanner, 24 Murray St., New York City.
Publisher, Trade News Publishing Co., 24 Murray St., New York City.
Owners: (If a corporation, give names and addresses of stockholders holding 1 per cent. or more of total amount of stock).
Trade News Publishing Co., 24 Murray St., New York City.
Joseph H. Wright, Tom's River, N. J.
G. A. Tanner, 24 Murray St., New York City.
Geo. W. Hills, Fairfield, Conn.

Known bondholders, mortgagees, and other security holders, holding 1 per cent. or more of total amount of bonds, mortgages, or other securities: None.

TRADE NEWS PUBLISHING CO.

G. A. Tanner, Sec'y and Treas.
Sworn to and subscribed before me this 26th day of March, 1914.

JOSEPH R. FRITH,

Notary Public Kings County. Certificate filed in N. Y. County.
(My commission expires March 30, 1914.)

Trade News From Near and Far

BUSINESS CHANGES

Rogers & Bals have purchased the business of Cornell Bros., in Ord, Neb.

G. E. Prentice has purchased the business of Batcher & Hand, in Staples, Minn.

C. W. Davis has purchased the business of Spurgin & Smith, in Konawa, Okla.

F. C. Gallagher has purchased the business of Zeilman & Nelson in Alta, Ia.

N. C. Elder has succeeded to the business of Elder & Adams, in Hutchinson, Kas.

A. J. Roe has disposed of his business in Creighton, Neb., to Dewey & Wilson.

G. E. Larson has purchased the business of Hoegh & Qualey, in Spring Grove, Minn.

H. H. Hafstrom has purchased the business of Williams & Doran, in Taylor, N. D.

D. C. Hutcherson has purchased the business of J. H. Nason & Sons, in Hepler, Kas.

Ole Johnson has purchased the stock of vehicles, etc., of Ole Odland, in Gayville, S. D.

W. W. Wheeler has purchased the business of West & McLeary, in Mitchellville, Ia.

C. D. Jenkins has purchased the H. B. Robinson stock of vehicles, etc., in Severy, Kas.

W. A. Wilson has purchased the stock of vehicles, etc., of S. Utzinger, in Racine, Minn.

W. F. Klotz has disposed of his business in Forrest City, Ark., to McDaniel & Watson.

Peugh & Markley have been succeeded in business in Herington, Kas., by Fred Rohlf.

A. Anderson has been succeeded in the vehicle business in Malvern, Ia., by W. H. Tabor.

Frank Gunther, of Woodbine, Kas., has sold his business to Earl Kellogg, of Herington, Kas.

E. J. McDougall has succeeded to the business of J. E. McDougall & Son, in Britton, S. D.

G. D. M. Keen has sold out his stock of vehicles, etc., in Clifton, Kas., to C. & F. Thomas.

Goodell Bros. have disposed of their stock of vehicles, etc., in Weston, Neb., to E. G. Ernst.

F. H. Bings has succeeded to the business of the old firm of Pings & Clauson, in Conrad, Mont.

Frank Brant has purchased the stock of vehicles, etc., of Bentley & Biere, in Fairbanks, Ia.

Bailey & Detweiller have purchased the S. L. Feister stock of vehicles, etc., in North Loup, Neb.

Frank First, Dowagiac, Mich., dealer in vehicles, harness and horse supplies, has decided to go out of business.

Mrs. Margaret A. McIntyre, executor of the estate of the late Dugald C. McIntyre, filed a certificate to do business in North Tonawanda, N. Y., under the firm name of the McIntyre Wagon Works.

The implement and vehicle store of Schulenburg-Beck Co., at Tipton, Ind., has been purchased by Eikenberry Bros., who are engaged in the same line of business at Rushville, Ind. They will operate both stores.

NEW FIRMS AND INCORPORATIONS

F. C. Hepp is putting in a stock of vehicles, etc., in Botna, Ia.

The Merced Hardware Co. has opened a branch in Atwater, Cal.

Sine Bros. are about to put in a line of buggies in Glendale, Ariz.

Wilt Bros. have opened a new stock of buggies, etc., in Rossville, Kas.

Stanley Kornovech has opened a new stock of vehicles in Foley, Minn.

J. H. Benne has opened a new stock of vehicles, etc., in Stanton, Neb.

P. M. Anderson & Co. have opened a stock of vehicles, etc., in Filley, Neb.

W. W. Bernard is about to open a stock of vehicles, etc., in Mitchell, S. D.

Edgar Bros. have opened an implement and vehicle store at El Centro, Cal.

E. S. Schoonover has opened a new stock of vehicles, etc., in Eaton, Colo.

L. J. Berg has engaged in the vehicle and implement business in Hanson, Neb.

D. H. Curran has opened a new stock of vehicles, etc., in Westhope, N. D.

Kenneth McCarter has opened a stock of vehicles, etc., in Mobridge, N. D.

Kennedy & Wylie are adding a line of buggies to their business in Larned, Kas.

B. P. Terry has engaged in the vehicle and implement business in Balaton, Minn.

M. A. Wendt & Co. have opened a new stock of vehicles, etc., in Triumph, Minn.

E. J. Tschann has opened a new stock of vehicles and implements in Pangburn, Ark.

Lux & Colborn have opened a stock of vehicles and implements in Bloomfield, Neb.

E. W. Hamilton is about to engage in the vehicle and implement business in Leon, Ia.

T. Bales has established himself in the vehicle and implement business in Libertyville, Ia.

Scott Bros. & Boyce have engaged in the vehicle and implement business in Carroll, Ia.

Everson Bros. have engaged in the vehicle and implement business in Washburn, N. D.

C. A. Anderson is putting in a new line of vehicles and implements in Central City, Neb.

Stiller Bros. have engaged in business in Oronoco, Minn., and will carry buggies and wagons.

W. H. Parkin has established himself in the buggy and implement business in Dwight, Kas.

John Gearhart, of Kenesaw, Neb., is about to open a vehicle and implement house in Denman, Neb.

The Standard Wagon & Truck Mfg. Co. has been organized in Detroit, Mich., with a capital of \$1,000.

The Star Hardware & Implement Co. has been incorporated in Ilo, Idaho, with a capital of \$10,000, and will handle vehicles.

The Inayle, Johnston Co., a new vehicle and implement firm, has been established by Geo. Inayle and C. H. Johnston at Eugene, Ore.

The Weyher Wagon Works has been incorporated at Black River Falls, Wis., with a capital of \$26,000, by E. T. Weyher, E. G. Heideman and Mabel Weyher.

The Hawkeye Carriage & Automobile Co. has been incor-

porated at Cedar Rapids, Ia., with a capital of \$15,000 by G. C. Schneider, D. A. Stofet and W. C. Henecke.

The Coleman-Harvey Buggy Co. has been incorporated at Miami, Okla., with a capital of \$4,000. The incorporators are C. M. Harvey, of El Paso, and L. G. Coleman and R. J. Tuthill, of Miami.

Sleeper, Fields & Kirkland have purchased an old furniture factory in East Muskogee, Okla., and will convert it into a factory for the manufacture of hardwood parts for wagons and buggies.

Mr. J. H. Truelove, of East Bend, has purchased the old high school building at King, N. C., and will remove it and convert it into a buggy factory. He will put in modern machinery and work several hands.

C. B. Rhyne, for the last eleven years general blacksmith and wagon maker for the Sandercook Transfer Co., San Luis Obispo, Cal., has opened a blacksmith and wagon repair shop on his own account on Toro street, in the same city.

The China Vehicle Co. has been organized at Portland, Me., to manufacture, deal in and operate vehicles of all kinds. Capital \$150,000. The new company is officered as follows: President, J. H. Pierce; clerk, D. W. Snow; treasurer, R. O. Brewster.

IMPROVEMENTS AND EXTENSIONS

Al Mastin, of Auburn, Neb., is erecting a new implement and vehicle house just west of his present location.

Pratt, Gilbert & Co., Phoenix, Ariz., have moved into a new concrete building, 100 x 137½ feet in dimensions. The company will handle vehicles, implements and hardware.

Losey & Co., dealers in carriage makers' and blacksmiths' supplies, Easton, Pa., have moved their business into their own new building at 122-124 South Third street.

Lewis & Chambers, leading Louisville (Ky.) jobbers of implements and wagons, are preparing to move from their present quarters on Main street, which they have occupied for 35 years, to a larger and more convenient building in the next block.

FIRES

The carriage shop of A. Green at Pensacola, Fla., was destroyed by fire April 22.

The stock of vehicles, etc., of Foree & Clark, in Aullville, Mo., has been destroyed by fire.

The carriage trimming and harness shop of Avery & Stone at Ashland, O., was damaged by fire on April 18.

Fire destroyed the plant of J. G. Wier & Co., wagon manufacturers, at Smallman and 28th streets, Pittsburgh, Pa., April 20. The two-story frame and brick building, 40 x 100 feet, was gutted.

The carriage factory of D. E. McCann's Sons at Portland, Me., was destroyed by fire April 25. The greater part of the loss was on 35 automobiles and many carriages which were stored in the building. Eight automobiles in one part of the structure were run out by policemen before they were damaged. Loss was estimated at \$50,000 at time of fire.

The Knapheide wagon factory at Quincy, Ill., had a narrow escape from destruction by fire April 4, when spontaneous combustion caused a blaze which damaged the big plant to the extent of \$2,000. The fire started in the basement stock room where bolts, nuts, paints and oils, unfinished wheels, etc., were stored. The flames were confined to that part of the plant through strenuous work of the fire department.

A fire loss of \$15,000 was sustained at the plant of the Mitchell Wheel Co., Miamisburg, O., April 17, when the hub and spoke department was destroyed. The origin of the fire is not known. The remainder of the plant, located in the close vicinity, was not damaged. Under date of April 20, Lee Mitchell, president of the company, wrote: "We had quite a blaze on the morning of the 17th, and while our loss was quite large, it will in no way interfere with our filling orders. Fire occurred at 1 a. m.,

and we started up as usual at 6:45. Our factory proper was not damaged, and our main supply of stock was not touched, so that we are running full blast, without interruption."

FRANCIS H. GLIDDEN RESIGNS

Francis H. Glidden has resigned from the office of president of the Glidden Varnish Co., Cleveland, O., after 31 years' service as head of the company. Mr. Glidden is past 80 years of age but is still active and in good health.

Following his resignation the office of chairman of the board of directors was created to which he was unanimously elected. Officers of the company then were elected as follows: President, Fred A. Glidden; vice-president, F. K. Glidden; treasurer, W. J. Glidden; secretary, R. S. Leonard.

MILWAUKEE RETAINS CONVENTION

The board of directors of the Wisconsin Retail Implement and Vehicle Dealers' Association has selected Milwaukee as the location for the next annual convention and exhibition of the organization. The exhibition will be held the second week of December and the convention December 8, 9 and 10. It had been proposed by some of the members of the association to hold the convention at some other Wisconsin city this year, but the directors decided that Milwaukee was the logical place, and the only one that could furnish the required facilities for the exhibition.

A LITTLE TIRE FRICTION

Claiming that the Kelly-Springfield Tire Co.'s proposed plan for readjusting its finances is "unjust, unfair and one of the worst examples of high finance that has ever been proposed," A. M. Polack & Co., brokers in New York, has issued a call to the stockholders to oppose the plan. The charge is made that whereas the charges which may accumulate against the company under the present capitalization amount to but \$68,970 per year, under the proposed plan the accumulation would be \$411,229 each year.

PRIZE FOR NEW TIRE MATERIAL

A nonrubber automobile tire which will be cheaper than the present kind, yet possess certain standard resiliency and durability, is being sought by the war department of Austria, and a prize of \$10,000 will be awarded to the person who fulfills the conditions, submitting a small or working-size model suitable for motor freight wagons, on or before June 30 of this year. Besides the specific attributes of pure rubber, such as adhesiveness and elasticity, the new material must not be heavier than pure rubber, and it must be more economical in use.

ELECTRIC VEHICLE IN PARCELS POST SERVICE

At the meeting of the Electric Vehicle Association of America which was held on Friday, May 22, in the new auditorium of the Consolidated Gas Co., 130 East 15th street, New York City. S. G. Thompson, of the Public Service Electric Co., Newark, N. J., presented the principal paper. It was entitled, "The Electric Vehicle in Parcels Post Service for Economy and Reliability."

WILL MANUFACTURE SPRINGS

The Penn Spring Works, Baldwinsville, N. Y., has been incorporated with a capital stock of \$28,500 to manufacture springs for wagons, carriages and other vehicles. The incorporators are: W. H. Robinson, F. D. Robinson, N. Hee, Baldwinsville, N. Y.

OBITUARY

Louis Bauer, 62, who has been conducting a wagon painting and repair shop at 457 W. 46th street, N. Y. City, died at his home in Union Hill, N. J., on May 5. Deceased was born in Germany and came to this country when a young man. He is survived by five sons and four daughters. The son Louis will conduct the business hereafter.

Samuel R. Bell, 65, president of the Union City (Ind.) Body Co., also of the Union City Works, died suddenly April 25, of heart trouble. He leaves a wife. No children survive. The remains were taken to Wooster, O., for interment.

John Carr Beyerlein, 60, 5626 South Park avenue, Chicago, a retired carriage and automobile manufacturer, died at his home April 30, of heart disease. His health has been poor for more than a year. A widow survives. Mr. Beyerlein retired two years ago.

Harry E. Hansen, 37, treasurer of the Wisconsin Wagon Co., Madison, Wis., died in a sanitarium at Milwaukee, April 22. Afflicted with nervous trouble, Mr. Hansen went to the sanitarium last December. He died of pneumonia which developed recently. His father is the president of the Wisconsin Wagon Co. and his brother is the secretary. He is survived by his widow.

John K. Gillespie, 68, in the carriage making business at Calais, Me., died May 2. His wife and three children survive him.

Christian Kumm, 73 years old, a retired wagon maker of Pittsburgh, Pa., died April 25 in his home, 527 Avery street, Northside. He was born in Germany and moved to the Pittsburgh district when a lad.

William Leonhardt, 71, president of Leonhardt Wagon Co., of Baltimore, Md., died May 8, of a complication of diseases at his home at Parkville. Mr. Leonhardt was born in Baltimore and founded the concern of which he was the head. The company manufactures fire trucks, circus wagons and various other vehicles. Mr. Leonhardt was the inventor of the hoisting coal delivery wagon. He is survived by his widow, two sons and five daughters.

R. H. Lyon, 79, who died at his residence, 4557 Evans avenue, Chicago, on April 9, after a brief illness, was buried at Hillsdale, Mich. He was born in Syracuse, N. Y. He located in Chicago in 1872 and was engaged for many years in the manufacturing of carriages and of late years was in the automobile business.

Sidney W. Miller, 70, for many years in the carriage building business in St. Johnsbury, Vt., died April 29, of cancerous trouble. He retired several years ago on account of failing health.

James Mullen, for many years in the carriage and wagon building business at Waltham, Mass., died May 9 after a brief illness. His widow, one son and six daughters survive.

Guy McAllister, 77, died at Bucksport, Me., on May 6. For many years he was engaged in the carriage building business in that city.

D. E. Prosser, 63, former carriage maker of Bowling Green, O., died in Detroit, April 18. His remains were taken to Bowling Green for interment. His wife and three daughters survive him.

James K. Sutton, 55, and with the carriage manufacturing firm of Brewster & Co. since he was a lad of ten, died at his home, 181 Fifteenth street, Brooklyn, April 22. He was unmarried.

John H. Scherer, cashier of Durant-Dort Carriage Co., of Flint, Mich., died in the Jackson City Hospital April 3. Mr. Scherer was in the hospital for an appendicitis operation, and some other complications were discovered. The operation was successful and reports had been uniformly favorable, in fact, he had been receiving callers and was upon the convalescing

diet. Mr. Scherer went to Flint about 15 years ago with the Imperial Wheel Co., and has been identified with the Durant-Dort Carriage Co. interests ever since.

WILL QUIT BUSINESS

The Charles H. Albrecht Co., carriage goods dealers, have arranged to quit business. The company has sold its entire stock of merchandise to Mosman & Yarnelle, Ft. Wayne, Ind.

WANTS

Help and situation wanted advertisements, 1 cent a word; all other advertisements in this department, 5 cents a word; initials and figures count as words. Minimum price, 30 cents for each advertisement.

HELP WANTED

Wanted—Superintendent for carriage factory in Canada. Capacity 12,000 jobs, carriages and sleighs. High grade work. Address, Box 23, care The Hub, 24 Murray St., New York City.

PATENTS

Patents—H. W. T. Jenner, patent attorney and mechanical expert, 606 F St., Washington, D. C. Established 1883. I make a free examination and report if a patent can be had and exactly what it will cost. Send for circular.

INDEX TO ADVERTISERS

Baltimore Hub-Wheel and Mfg. Co.....	40
Cargill Company, The.....	40
Columbus Bolt Works.....	4th cover
Dowler, Chas. L.....	40
Eccles, Richard, Co.....	2
Fairfield Rubber Co.....	3d cover
Gerhab, Jacob	2
Gifford, John A., & Son.....	2
Jones & Co., Phineas.....	3d cover
Keystone Paint & Filler Co.....	3d cover
Lawson Co., F. H., The.....	3d cover
McKinnon Dash Co.....	4th cover
Masury, John W., & Son.....	2d cover
Meyer, John C., & Co.....	40
Miller Bros.	40
Mulholland Co., The.....	40
Murphy Varnish Co.....	4
National Spring & Wire Co.....	4th cover
Palm, Fechteler & Co.....	2
Pierce, F. O., Co.....	2d cover
Porter, H. K.....	2
Schlegel Mfg. Co., The.....	40
Sheldon Axle Co.....	2
Sherwin-Williams Co., The.....	1
Skinner Bending Co., The J. M.....	40
Standard Oil Cloth Co.....	3
Technical School for Carriage Draftsmen and Mechanics..	40
Virginia and North Carolina Wheel Co.....	1
West Tire Setter Co.....	3d cover
White-Quehl Mfg. Co.....	40
Wilcox Mfg. Co., D.....	1
Willey Co., C. A.....	4th cover

Do you know what this

emblem stands for?



IT MEANS bigger, better, cleaner business. It is the inspiring insignia of 140 clubs, with a membership of over 10,000 earnest men. Learn what the Associated Advertising Clubs of America are doing for honesty in business, for more systematic, scientific and successful methods of distribution, advertising and salesmanship. Attend the Tenth Annual Convention of the A. A. C. of A.

TORONTO

JUNE 21-25, 1914

Interesting Program

The program for this great convention is comprehensive and diversified, covering every phase of modern merchandising. The sessions will be addressed by able, successful men; open meetings, devoted to a wide range of special topics, will give everybody a chance to ask questions and hear his own problems discussed by the men who have met and solved them.

Edward Mott Woolley

the famous writer on business topics, has made a study of the A. A. C. of A. and their work, as well as of the plans for the Toronto Convention. He has embodied the result in a little book, "The Story of Toronto." This book paints a graphic, inspiring picture of what this great movement signifies.

It will be sent free to all business men asking for it on their business stationery—together with detailed facts as to the convention program and rates for accommodations

Address

CONVENTION BUREAU

Associated Advertising Clubs of America

Toronto, Canada



No. 112.—Milk Wagon.

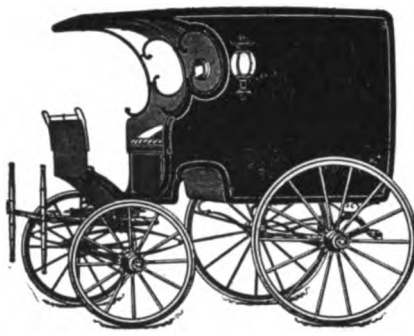

No. 111.—Altman Wagon.



No. 113.—Grocery Wagon.

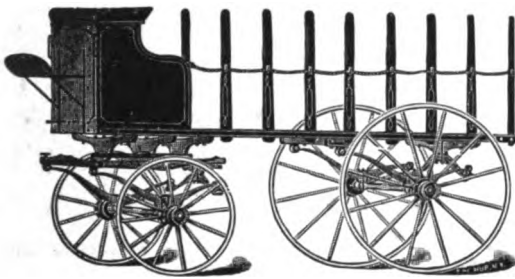

No. 122.—Flour Truck.

Electrotypes

of the vehicles presented on this page will be forwarded on receipt of

75 cts.

for each cut, to any address. Postage prepaid.

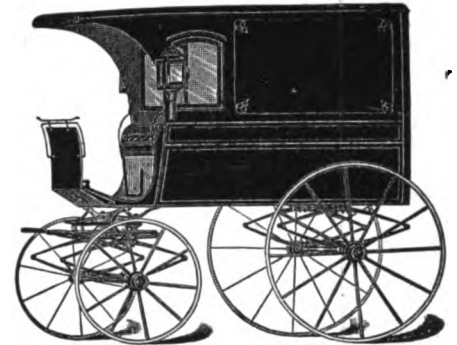

No. 115.—Delivery Wagon.

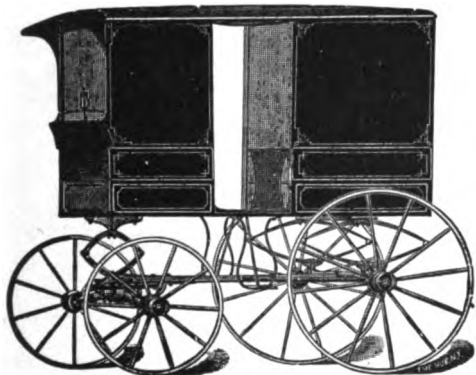

No. 116.—Milk Wagon.

Catalogue

containing nearly 200 illustrations of carriages, wagons, sleighs, and miscellaneous cuts will be sent upon application.

Trade News Publishing Co.
24-26 MURRAY ST.
NEW YORK

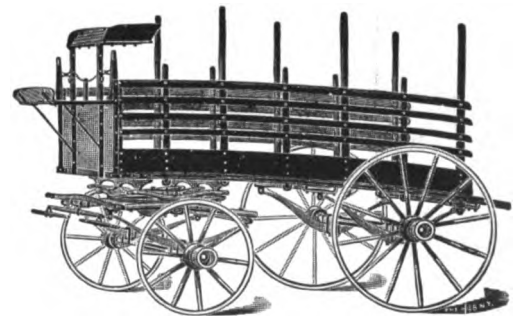

No. 117.—Merchandise Truck.



No. 114.—Delivery Wagon.



No. 124.—Delivery Wagon.



No. 118.—Ambulance.

BUSY BUYERS BRIEFS

MEYER THREADS AND SPOOL SILKS

are superior to all others; also ready wound bobbins to fit any style of sewing machine. Samples and prices for the asking.

John C. Meyer Thread Works
Lowell, Mass.

Baltimore Hub-Wheel & Mfg. Company
Manufacturers of

Wheels

AUTO
MOTOR CAR
CARRIAGE
WAGON

Also SPOKES and RIMS

Factory: Harford Ave. and B. & O. R. R.
BALTIMORE MD.

CHARLES L. DOWLER

CARRIAGE AND WAGON HARDWARE

108 North Third St., Philadelphia, Pa.

CUSHION MANUFACTURER

Pure Stearic Acid Candles. Wheel Stock. Snow
Flake Axle Grease.

MULHOLLAND BUGGY SPRING

Reduces weight of springs one-half.
Made in one size only but will fit bodies
of all widths.

Write for further particulars and prices.
THE MULHOLLAND CO. DUNKIRK, N. Y.



LINED

White's Brazing Sleeves

For applying Rubber Tires
Send for Samples.



UNLINED

WHITE-QUEHL MFG. CO.

431 E. Pearl St.
CINCINNATI, OHIO

AUTOMOBILE

**Bodies AND CARRIAGES
IN THE WHITE**

Estimates Furnished on Special Designs

MILLER BROTHERS

Amesbury, Mass.

The Schlegel Mfg. Co.

Rochester, N. Y.

Manufacturers of Coach Lace
and All Other Interior Trimmings



One of the oldest and
largest Rim Plants in
the world.

BENT RIMS

For Carriage and Wagon
Wheels
For Automobile Wheels

We make prompt deliveries in
HICKORY and OAK RIMS.
THE J. M. SKINNER BENDING CO.
Toledo, Ohio

Carriage Mechanics

Desiring to improve their present
Condition should attend the

TECHNICAL SCHOOL

FOR

Carriage Draftsmen and Mechanics

SUPPORTED BY THE

Carriage Builders' National Ass'n

The object of the School is to teach men to design vehicles and make working drawings, and to otherwise facilitate their work in the shop. Only those men employed in carriage or automobile building or their accessory trades are admitted to its privileges.

The classes are conducted in three divisions, viz.: Corresponding, Day, and Evening. The former is open during the entire year, while the day and evening classes are in session only from October 1 to April 1.

The tuition is moderate.

For prospectus and full particulars, write to the instructor,

ANDREW F. JOHNSON,

20 West Forty-fourth St.,

NEW YORK CITY

Cargill Service

has brought to the Cargill Company more Vehicle Catalogues than are made by any other printing house in America.

Cargill Quality is bringing The Best Automobile Catalogues to our plant for Complete production—watch for our imprint in the Season's best books.

THE CARGILL COMPANY

DESIGNERS
ENGRAVERS



PRINTERS
& BINDERS

Grand Rapids, Michigan

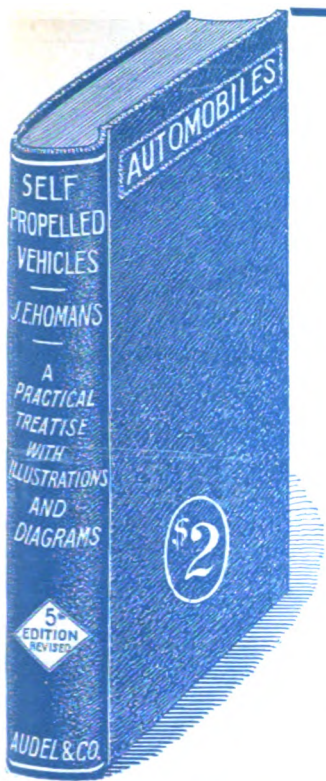

"Self-Propelled Vehicles"

Fifth Edition, Revised.

A practical treatise on the theory, construction, operation, care and management of all kinds of Automobiles.

By

JAMES E. HOMANS, A.M.

Contains 608 pages and upwards of 500 illustrations and diagrams, giving the essential details of construction and many important points on the successful operation of the various types of motor carriages driven by steam, gasoline and electricity.

This work is now the accepted standard, explaining the principles of construction and operation in a clear and helpful way. This book will be sent postpaid to any address in the United States, Mexico or Canada upon receipt of \$2.00.

Address

Trade News Publishing Co.

24 Murray Street, New York

Lawson's Sunken Panel, Twin Metal Buggy Seats

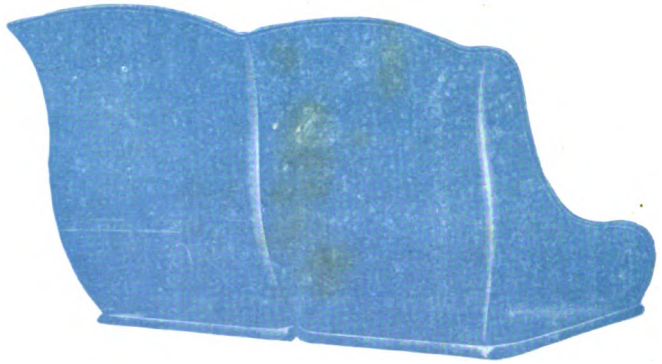

The Strongest—Neatest on the Market

Made in six sizes of 20 gauge automobile sheet metal. The Lawson seats are edged and bumped together by heavy presses.

We Use No Solder

Our seats were never known to come apart or rumble.

Write for Prices

The F. H. Lawson Co.

(Established 1816)

Cincinnati - - - Ohio

1855—Standard for 59 Years—1914

Jones Wheels

"Best on Earth"

The Name of Jones as Applied to Wheels Means the First, Last and All-the-Time Word in Wheels

"Kantsamore"

Buyers of vehicles should say, "Give me wheels made by

Phineas Jones & Co.

NEWARK

NEW JERSEY

U. S. A.

THE FAIRFIELD RUBBER COMPANY

Manufacturers of

Carriage Cloth, Imitation Leather,
Automobile Cloths, etc.

FAIRFIELD,

CONNECTICUT

The WEST Hydraulic Tire Setter WILL CUT DOWN EXPENSE

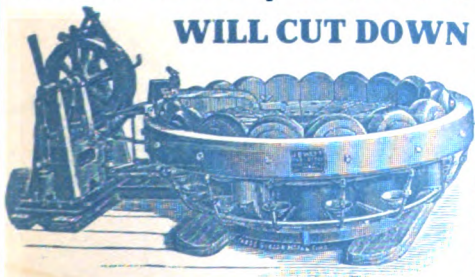

Tires set cold in one minute. This machine saves time—does the work better and quicker, does away with burned streaks. Only necessary to measure one wheel in a lot. Does not char the rim, and thus make the tire loosen prematurely.

Saves resandpapering of wheels. This machine is now increasing the profits of many manufacturers. Send for catalog and read about it.

WEST TIRE SETTER CO.,

ROCHESTER, NEW YORK

KEYSTONE BLACK FILLER

MAKES A PERFECT

ROUGHSTUFF

For Automobile Bodies and Parts

It fills the pores of Metal and Wood perfectly. Sandpapers easily and produces a fine smooth surface that DOES NOT CRACK, SCALE NOR PEEL.

POMEROY & FISCHER, New York
Selling Agents to Vehicle Trade

KEYSTONE PAINT AND FILLER CO., Muncy, Pa.

TROY, OHIO
CINCINNATI, OHIO

Your Vehicles will sell
against the
sharpest competition
if furnished with
**McKINNON
WING
DASHES**

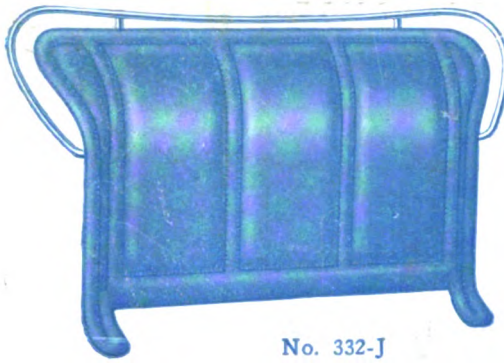

No. 332-J

ST. CATHARINES,
ONTARIO

**A
WING
DASH**
with Japanned Rail
that has a style and finish
to suit the
finest vehicle

McKINNON DASH CO. BUFFALO, N. Y.

"BLACK VELVET" CUSHION SPRINGS

Manufactured Only by the
NATIONAL SPRING AND WIRE COMPANY
ALBION, MICH. WINDSOR, ONT.

THE SPRING OF QUALITY.



SPRING or SOFT EDGE CUSHION FRAME
For Buggies or Other Vehicles. Built of the Highest
Grade of Steel Wire.

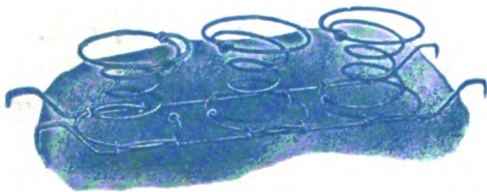

STRIP FOR WOOD OR BOX FRAME

WILLEY'S COLORS

The **RECOGNIZED STANDARD**



C. A. WILLEY CO.
COLOR GRINDERS

and Manufacturers of Specialties in
**CARRIAGE, AUTOMOBILE AND CAR
PAINTS**

COLORS, VARNISHES, ETC.

HUNTER'S POINT, NEW YORK CITY

Skewed Shaft Couplings

**Regular or Oval Patterns
For High Arched Axles**

Furnished in rights and lefts for any height of arch. Oval Axle
Clips $\frac{5}{8}$ or $\frac{3}{4}$ width to match Oval Couplings. Bolts, Clips,
Couplings, Carriage Hardware and Special Forgings

Catalogue "H" and Prices on Application

COLUMBUS BOLT WORKS, Columbus, O.

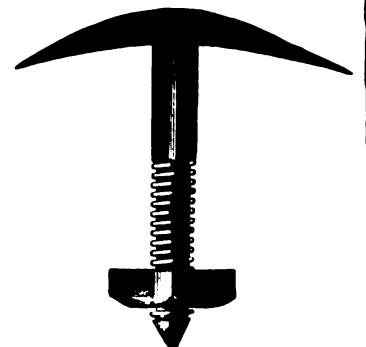
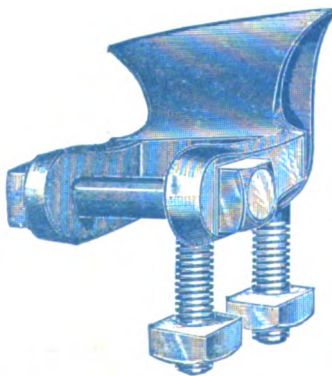

The Hub



TRADE NEWS PUBLISHING COMPANY
24-26 MURRAY ST. NEW YORK.

HOTEL DENNIS

ATLANTIC CITY, N. J.



Directly facing the sea and overlooking the famous boardwalk.

Every room connected with private bath or having hot and cold running water.

Within one square of Young's Million Dollar Pier, where Carriage Builders' Exhibit for 1914 Convention is held.

Capacity 600.

Walter J. Buzby

HOTEL CUMBERLAND

NEW YORK

BROADWAY AT 54TH STREET

Near 50th St. Subway Station and 53d St. Elevated.

"Broadway" cars from Grand Central Depot pass the door, also 7th Avenue cars from Pennsylvania Station.

New and Fireproof

Best Hotel Accommodations in New York at Reasonable Rates.

\$2.50 with bath and up

European Plan

All Hardwood Floors and Oriental Rugs

Ten minutes' walk to 40 Theatres

Excellent Restaurant

Prices moderate

Send for Booklet



HARRY P. STIMSON, Formerly with Hotel Imperial

Only New York Hotel window-screened throughout

JOHN W. MASURY & SON

Originators of

Superfine Coach and Automobile Colors

Acknowledged the Standard for Fifty Years

AND MANUFACTURERS OF

Fine Carriage and Automobile Varnishes

New York,

Chicago,

Minneapolis,

Kansas City

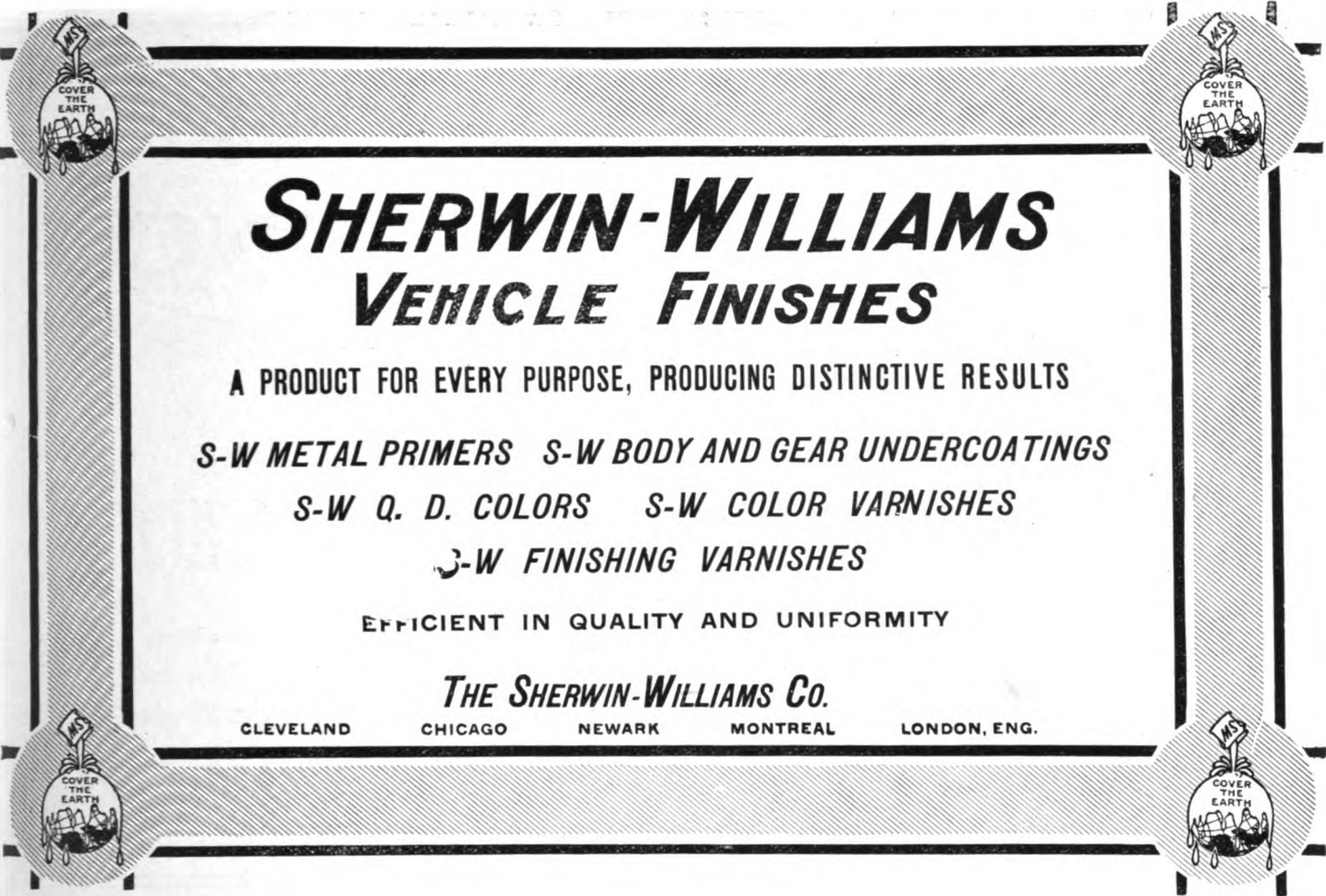

SHERWIN-WILLIAMS
VEHICLE FINISHES

A PRODUCT FOR EVERY PURPOSE, PRODUCING DISTINCTIVE RESULTS

S-W METAL PRIMERS S-W BODY AND GEAR UNDERCOATINGS
S-W Q. D. COLORS S-W COLOR VARNISHES
S-W FINISHING VARNISHES

EFFICIENT IN QUALITY AND UNIFORMITY

THE SHERWIN-WILLIAMS Co.

CLEVELAND CHICAGO NEWARK MONTREAL LONDON, ENG.

BENT RIMS Hickory Second Growth and Forest Hickory
All Grades
OAK—STAR BRAND

SPOKES Second Growth Hickory—Finished and Club Head
SUITABLE FOR ALL VEHICLES, INCLUDING AUTOMOBILES

VIRGINIA AND NORTH CAROLINA WHEEL CO.
8 Bridge Street, New York City RICHMOND, VIRGINIA



W I L C O X
FINE FINISHED FORGED
Carriage Hardware and Gear Irons
WRITE US FOR CATALOG No. 11B

The D. Wilcox Mfg. Co.
MECHANICSBURG CUMB. CO., PA.

1902

SHELDON AXLES AND SPRINGS

For Horse-Drawn and Power-Propelled
Vehicles of All Kinds

JUST ENOUGH BETTER THAN OTHERS TO BE NOTICEABLE

When you specify "Sheldon" you are not experimenting with experiments, but are getting Axles and Springs with years of manufacturing experience back of them—Axles and Springs that are selected for important work where conditions make reliability supremely important

SHELDON AXLE COMPANY - WILKES-BARRE, PA.

LARGEST AXLE AND SPRING FACTORY IN THE WORLD

PORTER'S BOLT CLIPPERS

"Easy" "New Easy" Allen-Randall



To Cut 5-16, 3-8, 1-2, 5-8, 3-4 Inch.

H. K. PORTER, EVERETT, MASS.

Richard Eccles Co., Auburn, N.Y.

Manufacturers of

Forgings: Carriage, Wagon, Automobile' Special

Send for Catalogue No. 18;

Also Catalogue of Special Automobile Forgings



DECALCOMANIE

TRANSFERS FOR ALL PURPOSES

We Carry the Largest and Best Assorted Line of Stock DECALCOMANIE in the World.

Special Designs of All Kinds, Name Plates, Seat Risers, etc., etc.

DECALCOMANIE ADVERTISING SIGNS OF ALL KINDS

No Shop Complete Without Our Catalog. Write for one.

PALM, FECHTELER & CO., 67 Fifth Ave., New York

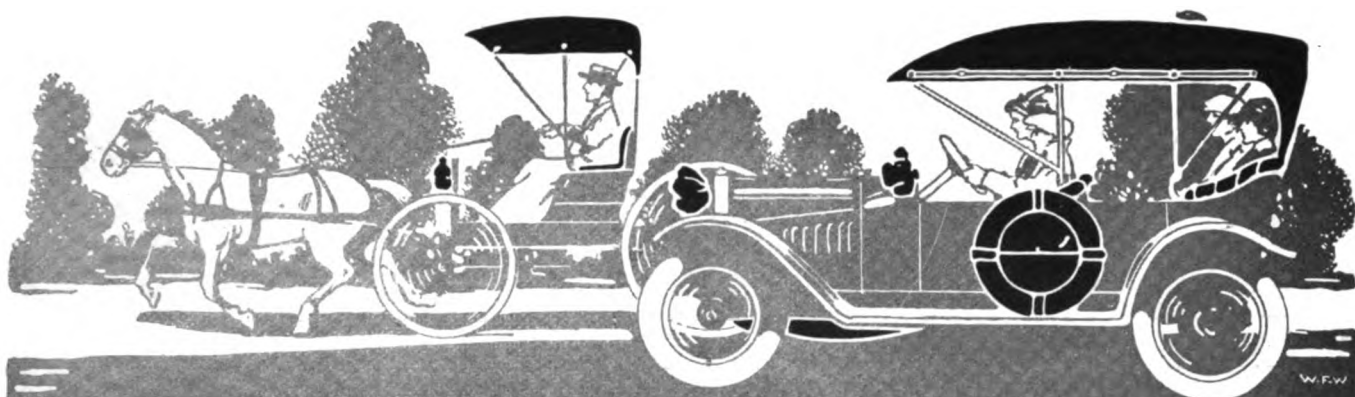

Learn More About The Leading Leather Substitute

Every carriage and automobile manufacturer—every manufacturer of carriage and auto accessories, storm curtains, aprons, lamp covers, tire cases, trunks, etc., should get and examine samples of

MERITAS

LEATHER CLOTH

Only by seeing the goods—by testing them—by noting the handsome, durable, non-cracking finish and the fine line of colors can you appreciate the high quality we have attained in the manufacture of a serviceable leather substitute.

There are styles, colors and finishes in MERITAS LEATHER CLOTH suitable for every carriage and auto trimming and upholstery purpose.

It can be had in muslin, duck and drill; dull or glazed; smooth or grained; in black and colors.

Sample book on request—write now and know more out the leading leather substitute.

Write
for
sample
book of
MERITAS
LEATHER CLOTH
NOW

Standard Oil Cloth Co.

320 Broadway, New York

Quality
Is
Economy

*Note these Testings of Our
Quick Motor Car Gear Special*

A Remarkable Varnish for Motor Car and Carriage Gears

- I A metal sheet finished with it, was put into a kettle of water and boiled *one* hour.
- II The sheet was plastered with soft alkali soap and allowed to stand *four* hours.
- III A solution of 50 per cent. Sulphuric Acid was poured on it and allowed to stand *sixteen* hours.

The Varnish came through all these tests with *no slightest trace of injury.*

The Varnish
That Lasts
Longest

Murphy Varnish Company

FRANKLIN MURPHY, President

Associated with Dougall Varnish Company, Limited,
Montreal, Canada

NEWARK
AND
CHICAGO

The Hub

Copyright, 1914, by the Trade News Publishing Co., of New York

Entered in the New York Post Office as Second-class Matter

Vol. LVI

JUNE, 1914

No. 3

THE TRADE NEWS PUBLISHING CO. OF N. Y. Publishers of THE HUB

J. H. WRIGHT, *President* G. A. TANNER, *Secretary and Treasurer*
24-26 MURRAY STREET, NEW YORK

Other Publications of Trade News Publishing Co.:

HARNESS (monthly).....per year, \$1.00
AMERICAN HARNESS AND SADDLERY
DIRECTORY (annual).....per copy, \$5.00

The HUB is published monthly in the interest of employers and workmen connected with the manufacture of Carriages, Wagons, Sleighs, Automobiles and the Accessory trades, and also in the interest of Dealers.

Subscription price for the United States, Mexico, Cuba, Porto Rico, Guam, the Philippines, and the Hawaiian Islands, \$2.00, Canada, \$2.50, payable strictly in advance. Single copies, 25 cents. Remittances at risk of subscriber, unless by registered letter, or by draft, check, express or post-office order, payable to the order of THE TRADE NEWS PUBLISHING CO.

For advertising rates, apply to the Publishers. Advertisements must be acceptable in every respect. Copy for new advertisements must be received by the 15th of the preceding month, and requests to alter or discontinue advertisements must be received before the 12th day of the preceding month to insure insertion in the following number. All communications must be accompanied by the full name and address of writer.

FOREIGN REPRESENTATIVES:

FRANCE—L. Dupont, publisher of *Le Guide des Carrossiers*, 78 Rue Boissiere, Paris. Subscription price, 15 francs, postpaid.

GERMANY—Gustave Miesen, Bohn a Rh. Subscription price, 12 marks, postpaid.

ENGLAND—Thomas Mattison, "Floriana," Hillside avenue, Bitterne Park, Southampton. Subscription price, 12 shillings, postpaid.

Entered in the New York Post Office as Second-class Matter

Better Now Than Later

Marriage and implement trade journals, through editorials and with cartoons, are urging Congress to adjourn and let business rest.

President Wilson is said to be determined to push the passage of the trust bills through Congress. From a national point of view it is just as well that the bills should be passed this session. "Business needs a rest," in what kind of rest will it get by working under undecided legislation to be enacted at the next session? It is well that business is suffering from uncertainty. How can that condition be improved by prolonging the uncertainty for six months?

At present we know just what the President wants and what Congress is expected to enact. We have no idea what the next Congress will do with them, and that Congress will not begin business for eighteen months. The prospect of legislation at the short session is really worth considering. An adjournment now would mean that until December, 1915, there would be continued agitation, no matter what the political complexion of the Congress elected next November may be, and that legislation wrought out of that agitation would be

passed in the spring or summer of 1916, under the disturbing influence of an approaching Presidential campaign. Is two solid years of agitation what business needs in order to compose its nerves and get a rest?

The people are entitled to know what is going to be done, and to know it now. If we are to have these trust bills let us have them now.

The Scranton Idea

The business citizens of Scranton have in process of organization The Scranton Industrial Development Company, capital one million.

The idea is a very ably worked out plan to increase the business growth of the city by a financial investment in both going concerns where advisable, and in the bringing of new concerns to the city.

This is a common practice the country over, but the Development Company has put it on an entirely new plane, by which all subscribers may have town pride if they like, but they are secured in a five per cent. investment that is as near perfect as possible, and a mountainous over other plans of similar purpose. Those interested ought to send to the Scranton Board of Trade for the literature, if only to see what clever men can devise in the way of a sure thing plus progress for a city.

Sounds Funny

The corporate nomenclature of the English is surely peculiar to those not used to it.

The Messrs. Engines, Ltd., for instance, sounds comical. Messrs. X. Y. Z., Ltd. Messrs. Cyclecars, Ltd., and this and that of the same order.

A group of butchers would think Beefsteaks, Ltd., the right thing, for a bunch of doctors, Messrs. Castoroil, Ltd. We haven't yet seen any fellows, with a proposition, who started out as Messrs. Dough, Ltd., but no doubt many could adopt that name most fittingly.

Tidy Sum to Pay for Depreciation

Kansas City owned eleven automobiles for which \$21,750 was paid. After two years use it sold them for \$3,657.50.

It looks as if \$18,092.50 was a tidy sum to pay for two years' use of less than a dozen vehicles, not to mention up-keep expense.

The chief item in the exports for June was the American polo cup, "lifted" by the British Big Four.

Ideal Automobile to Be Defined

That the design of the average motor car would be materially different from what it is were the engineer unhampered by the dictates of the manufacturer is generally accepted as true, but exactly what a car would be like that was based entirely on engineering considerations no one seems to know. Some inkling of its nature, however, is anticipated as a result of a discussion of "The Ideal Car," that occupied one of the sessions of the meeting of the Society of Automobile Engineers, at Cape May.

Oil From Bricks

An inventor has found and patented a process by which oil (shale oil) and other by-products can be extracted from the clay out of which bricks are molded, and when all is done there are the bricks, too, just as good as can be.

Such clay is often well saturated with such oil, and it helps to make the brick self-burning, so that less fuel for the burning is used.

The inventor has worked along such lines, and has been able to extract from 1,000 bricks 20 gallons of crude oil, 80 gallons ammoniacal liquor and 1,500 feet of gas.

Motorcycle-Cyclecar

The motorcycle, with some of its funny side attachments, seems to be in an evolutionary state. It looks as if the makers—some of them at least—were preparing to emerge from the chrysalis as cyclecarists. It would be a consistent evolution, and if the purse hung up by public demand is large enough, we feel sure many of the manufacturers will reach for it.

Its Quarter Century

The April issue of Australian Coachbuilder and Wheelwright was the 25th anniversary, yet we think of Australia as a "new" country. May our contemporary grow younger as it grows older, and be always as full of interest.

The Number of Automobiles

There are, according to authority, 1,253,875 automobiles as of the year 1913. This is total output figures for the auto of all kinds.

Let's see, this is about one year's production of buggies, when it is only a so-so year.

GOOD LUCK TO HIM

We learn that Mr. H. F. Crawford is nicely settled in the Phineas Jones & Co. Los Angeles branch, where he is in charge as general manager. We have no doubt of the success of Mr. Crawford, because his 21 years of experience in the Newark factory is necessarily an education in wheel making that is a rare advantage. When a man knows how a Jones wheel is made through and through, he knows something worth knowing about wheels.

THE MONTH'S ILLUSTRATIONS

The pictures this month are all from foreign sources, as they seemed to proffer more than was interesting.

The first is a torpedo (touring) body au naturel. Notice the simplicity of line.

The second is a "coupe-torpedo" that is very pleasing. The cane-wood finish makes a handsome body finish. This body is really suitable for both town and tours.

The third is the latest craze, the boat torpedo. We have our idea as to what would be the best use to put a torpedo to in this instance, but as it is personal, it would have no public interest.

The fourth is a limousine torpedo, like a three-volume novel very long. We have made a torpedo display of the fashions as that is the prevailing influenza abroad time present.

Interiors

At top, reading from left to right, we have a Rothschild boat torpedo interior. It is plain the lockers and stowaway places carry out the idea.

Next is a torpedo trimmed by Kellner Brothers that display a number of interesting details.

The two following illustrations are to show the use of the electric light for two purposes, to show the road, and to show the passenger it is not necessary to "watch your step." Both are well thought-out applications.

The next is a Lamplough torpedo interior, showing much use of wood, as well as ample closet room.

To the right is the same trimming idea as Boulogne & So consider it.

The bottom pictures are first, an inside drive, and a coupe limousine. Here we have in above example present European practice in trimming automobiles.

The working drawing is a plan of working out details of top for landaulet-torpedo.

ANNOUNCEMENT

The Carriage Builders National Association makes the following announcement concerning the forthcoming convention:

The forty-second convention and exhibition of the Carriage Builders National Association will be held in Atlantic City, N. J., from September 28 to October 2, 1914.

The exhibition from September 28 to October 2, inclusive.

The convention, September 29, 30 and October 1.

Both the exhibition and convention will be held on Young's Million Dollar Pier in that city.

The exhibition enclosure has been entirely rebuilt, and is larger, better, safer both as to the roof and the sides.

In this enclosure we will have ample room for our exhibitors. Aisles will be arranged both lengthwise and across the exhibition space. Thus every exhibitor will have an aisle on at least two sides of his exhibit, and in many cases on three sides. By this means every exhibitor will be able to show his goods satisfactorily.

The committee expects to arrange for the meetings in such a manner and with such subjects that the whole carriage trade will be both instructed and benefited. We expect this to be one of the very best of our conventions.

You are earnestly requested to arrange to be present; you will surely be repaid for your time and expense.

The usual excursion or tourist tickets to that city will be available for the meetings and exhibition.

By order of the executive committee.

Mount Vernon, N. Y. HENRY C. McLEAR, Secretary

THE NEED OF A TRUCK CONVENTION

The commercial vehicle committee of the National Automobile Chamber of Commerce has decided upon a convention of truck makers during the coming fall or winter.

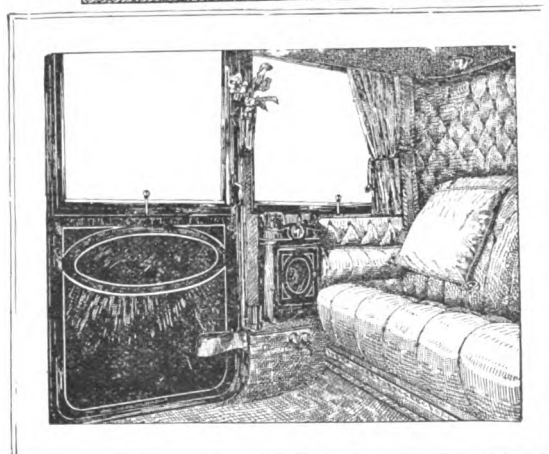
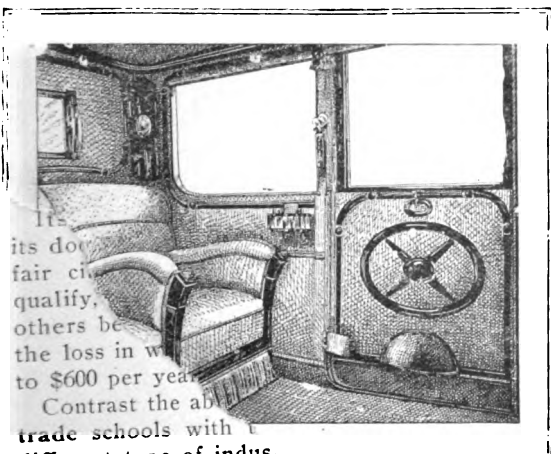
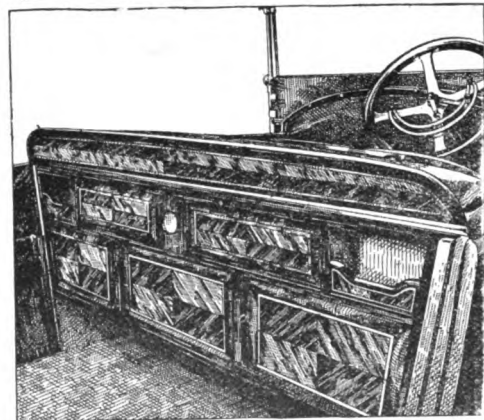
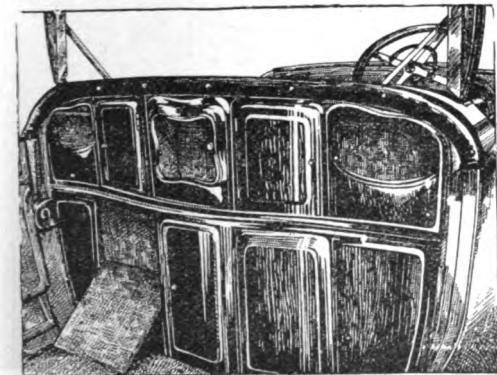
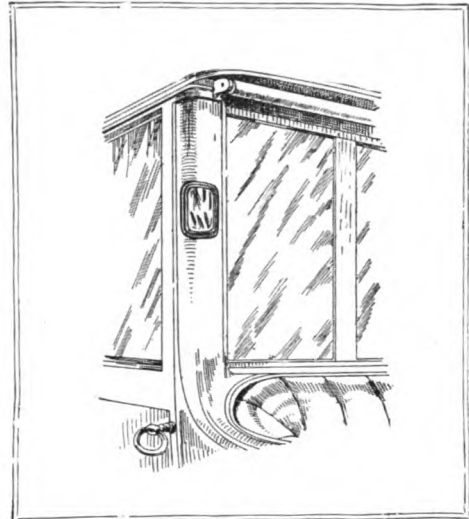
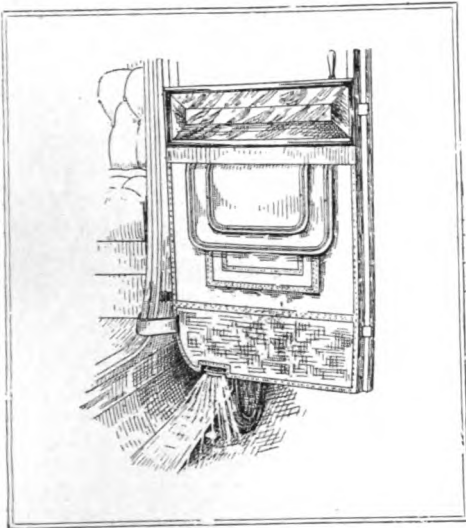
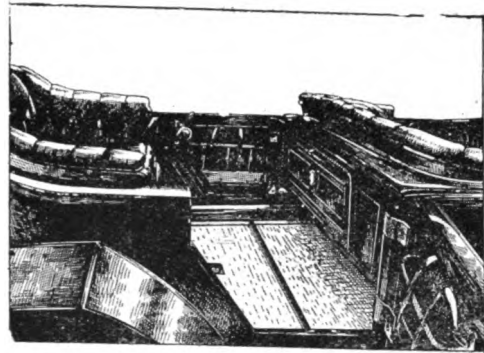
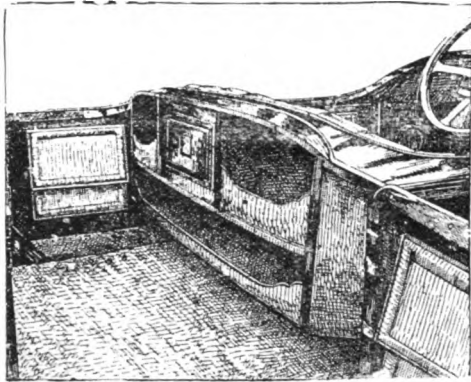

Its
 its do
 fair c
 qualify
 others be
 the loss in w
 to \$600 per year
 Contrast the ab
 trade schools with
 different type of indus
 school.

Wisconsin

Interiors

Wisconsin two years h
 who are or who have been in her industrial commu

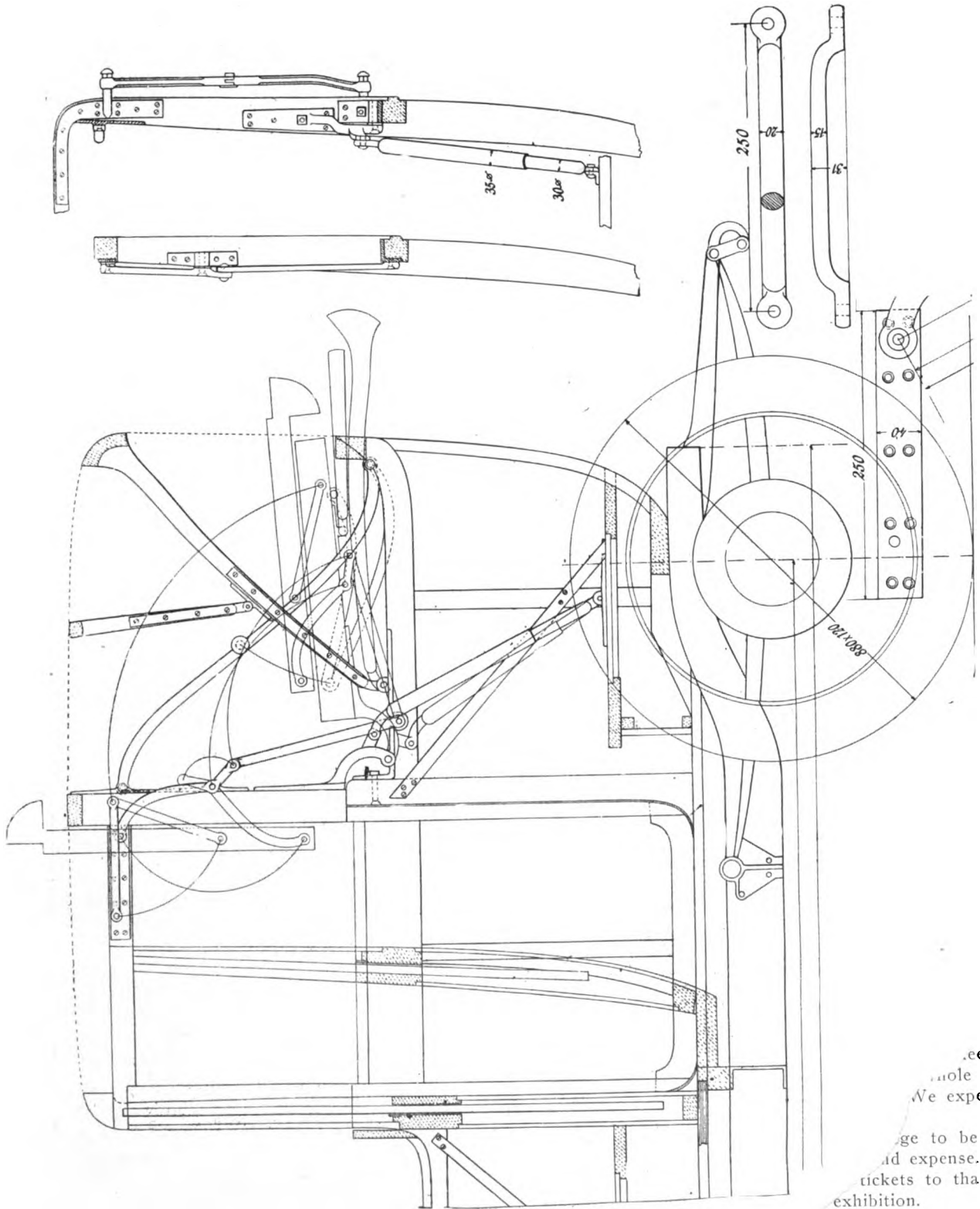

Working Details of a Landalet-Torpedo Top

side
his good

meetings in su
whole carriage tra
We expect this to

age to be present; y
ad expense.
tickets to that city will
exhibition.

committee.
HENRY C. McLEAR, Secretary

OF A TRUCK CONVENTION

vehicle committee of the National Auton
the Chamber of Commerce has decided upon a convention
truck makers during the coming fall or winter.

CONTINUATION SCHOOLS

The following account of the movement that is making industrial education effective has been sent us by H. E. Miles, chairman of the committee having the matter in charge. We have given just an outline of the work.

Industrial education is not merely a question of philosophy or of speculation. It is a project under rapid headway, with an ever accumulating body of new experience and information. That it must succeed primarily and in chief measure through the continuation school, is more and more apparent, if not now everywhere conceded.

The need of trade schools is as great as we have ever believed.

The trade school is, however, the apex (the "little end") of the pyramid of industrial education, resting properly, as a condition precedent, upon the education of industrial workers generally in continuation schools. Its province is to receive the most promising from the great body of moderately instructed pupils in the continuation schools and to train them for the higher places in industry, to advance them towards positions of real leadership.

We of the United States, blind to the experience of other countries, have tried for 30 odd years to build the apex of our pyramid before laying its foundation, and small indeed has been our accomplishment.

In the 30 years from 1880 to 1910, in spite of all the hue and cry, only about 13 trade schools were established. These had a total enrollment of 1,500 to 1,800 regular pupils, with a cost per student year of about \$250 to the state, or \$300 if interest on plant is included. To this is to be added the student's loss of income, say \$400 per year, making a total expense to state and students of \$700 per year. No wonder the schools were never full and the number benefited so slight as to make it a question in the minds of some whether such schools were worse than nothing, because they quieted the conscience and narrowed the vision as to the larger moral, economic and social obligation. A recent statement of the Connecticut State Board of Education pleads for the continuation school, saying that there are from 40,000 to 60,000 children between the ages of 14 and 18 in that state in need of such industrial education. These children are now out of school and in employment, most of them having left by the end of the sixth grade.

Connecticut has been experimenting with the subject by expending \$50,000 per year in the two cities of Bridgeport and New Britain in all-day, all-week schools at a cost to the state of about \$200 per student year, taking this money from everybody's pocket through state taxes, and devoting it to only 250 children out of the 40,000 to 60,000 whose need and whose right is equal to that of the 250. We need not take time either to rejoice for what she has done for the 250 or sorrow at her neglect of the 40,000. She was, at least, one of the first states to take any action at all and it is a delight to note that bills are pending before her legislature establishing continuation schools throughout the state.

The Milwaukee Trade School, established largely by the beneficence of her manufacturers, after long years has only 100 students, less than half the school capacity.

Its cost in maintenance alone is \$250 per student year, and its doors locked, as it were, against the many thousands in that fair city desperately in need of this schooling, but unable to qualify, some because they lack the eighth grade certificate, others because they are under 16 years of age, others because the loss in wages to these 16 to 19 year old pupils is from \$450 to \$600 per year, and they won't suffer this loss.

Contrast the above 30 years experience in these old fashioned trade schools with the new experience in Wisconsin in that different type of industrial school—the industrial continuation school.

Wisconsin Reaching the Masses

Wisconsin two years hence will have from 20,000 to 40,000 who are or who have been in her industrial continuation schools,

many of them splendid in promise, ability and enthusiasm. Indeed, today enough could be picked out to make several trade schools larger than any now in America, and everyone an extra good man.

The trade school of the future will be far less on the order of a close corporation, far less for the favored few only, favored financially, not intellectually.

It will give the utmost of opportunity to the bright fellow who can come nights only, or only a few hours of daytime per week, also to the half time "co-operative" students, who by special arrangement between school and factory take "a week about" between school and factory as in the Cincinnati College of Engineering, where under natural selection, factory workers are being lifted from the lower levels to the top places in American engineering, earning their way splendidly as they go. And, lastly, those who can spend all the time in study will be cared for somewhat as at present, but with greater care for the individual as such and less of pressure into classes and squads as such.

We may well be grateful to the directors of trade schools for doing what the country has permitted them to do these long years. None will rejoice more than they in the coming new industrial continuation schools and the new trade schools, and none are doing more to hasten the day of general trade education of the masses with their millions of pupils underlying the trade schools of the future.

Compulsory attendance from the fourteenth to the sixteenth year (better the seventeenth or eighteenth) is necessary for children in employment and for that 50 per cent. of the child life of the nation which leaves school by the end of the sixth grade. Anything else is a continued playing and compromising with right and necessity. This education is not a boon nor a privilege. On the part of the child, it is a birthright. On the part of the state it is absolutely necessary for the safety and advancement of society. To leave attendance optional is to substitute for necessity and right, personal preferences, good nature and more or less cheap persuasion. It is to have some employers and some parents do right because they are willing to and others sacrifice the child life entrusted to them for any one of a thousand cheap excuses. When any state, notably one like Massachusetts, seeing the right, so legislates, argument and cavil are dispensed with and the public in short order happily conforms.

There is no chance that Wisconsin will be over-proud or over-confident in her work. She will have to demonstrate continually that her industrial continuation schools are real industrial continuation schools and not merely general continuation schools with a smattering of the industrial. She is simply doing the altogether common sense and ordinary thing, as previously done for 100 years in countries more enlightened educationally. The last figures from Wisconsin are, however, a demonstration.

Her laws were passed too late in 1911 for much to be accomplished in the school year 1911-12. Only two schools were started—with 700 pupils. Last fall about 30 schools were opened—with from 3,000 to 5,000 pupils. In November, the enrollment was 10,000 and by February it had risen to 16,000. Half of the pupils, those between 14 and 16, are enrolled under the compulsory attendance law; the others or the older ones are in voluntary attendance, mostly in the evening schools. The state limits its aid to 30 schools and \$3,000 to any one school. The number of schools will be increased to 45 by the legislature now in session. The number of students next year will not be less than 25,000; it may be much more than that.

The compulsory attendance is for only five hours a week and the aid is limited to one-half the actual maintenance charge. Except in Milwaukee, the \$3,000 limit will meet half the expense of each school.

This expense per student year proves to date to be about \$10. The students continue in employment, and almost invariably by grace of the employers, without loss of wages for the hour spent in school. Contrast this \$10 per year per student with

the \$30 average cost in the elementary schools of the country, \$75 in the high schools, \$100 to \$250 in the so-called trade high schools and \$250 or more in trade schools. An additional \$250 to \$450 or more must be added to the latter figures, as the student's loss of wages.

It would seem that such figures as these should act as a foreclosure on debate, and cause everyone to turn his back upon the old attempts and give speedy and even-handed justice to the great body of the working people and their children through continuation schools. Too long have Americans measured accomplishment by money expended and felt that big money appropriations are the surest way to success. The wisdom of those who framed the Wisconsin laws on industrial education enables and requires her state and the local boards to make shrewd social engineering and co-operative effort take their proper place as infinitely better than great money expenditure.

To care for her 16,000 students not a single building was erected; in only one city was there any outlay worth mentioning for rent and the expenditure for equipment was very slight.

While the continuation school gives practical industrial training to the industrial worker after he has left the common schools, and usually gives him a total of only a half day's or a day's instruction per week, he being excused from employment for that time, it is by no means limited to this. In Fond du Lac two domestic servants are going from ten to twenty hours per week; two boys, working for their father, are going ten and fifteen hours. In Racine a boy of 16 who had worked only two days in two years was compelled to attend school five hours per week. After a few days he inquired: "Can't I stay more than five hours?" He then went continually till he got a good job and then again for five hours.

It is of extreme consequence that children (and adults, too) be not abandoned to idleness and temptation when temporarily out of work; that unemployment be made a time of great value. Consequently in Wisconsin the children of 14 to 16 years who must attend five hours per week when employed, must (and their elders may) when out of employment, attend these schools in the usual all-day period. Consequently, dull time, "off seasons" and unemployment are time of great opportunity, and may be the happiest, best days of all, counting most for life advancement and profit.

Picture for an instant the worth and blessedness of this system as against the murderously negligent old ways.

There is no trouble finding teachers in the industries for the first years of instruction in industrial schools. This is because the schools are so simple, at the start, largely because the present schools have been, and are, so strangely unsuccessful in teaching even simple numbers, and so forth, to those who quit the course half-way, and become the country's industrial workers.

But to train these teachers and keep them well ahead of their classes, to make instruction continuously more practical as opportunity offers and at the same time, better and more closely related to work-a-day requirements, to keep it from the deadly tendency to become formal and set—this is the task as respects teachers.

To this end industrial continuation schools for teachers are necessary. It is impossible to get any number of good mechanics to lose incomes and incur expense in attending normal schools and in the minds of some that is not the place for them to go anyway.

The Massachusetts authorities advise continuation schools for teachers. There is such a school in Milwaukee. Out of the thousands in the continuation classes there and from the teaching force itself, many indeed will be developed into especially competent, practical and scientific teachers.

Let it be noted that fewer teachers will be needed than is often supposed. In industrial continuation schools, the only industrial schools possible for the multitude, with only five to twelve hours schooling per pupil per week, each teacher may

care for from five to seven times as many children as in the common schools.

There are also, by the way, thousands of graduates of the European industrial continuation schools in our industrial centers, in employment and out, ready to instruct in our new schools.

"ALL KINDS OF WHEEL RIMS CAN NOW BE MADE FROM THE WOODPILE"

Some time ago a noise was made about the crown and segment rim, and a few hundred wheels with Sarven hubs and this rim were tried out. Well, those wheels are standing up yet, and are testimony to the good idea that has been put in operation.

The New Wapakoneta Wheel Co. now has control of the patent, and the words quoted above express what General Manager Trau, of the wheel works, thinks about it.

When you think it over the wheel ought to be what the farmer calls a hardy variety, because it is hard to see how the seasons can affect it. Neither shrinking, swelling, cold or heat can budge it. The way this is brought about is interesting and worth telling.

The main feature of the new rim is that the tire cannot come loose, and the rims do not split. The best feature, from the standpoint of the manufacturer, is that the rim, instead of being in two pieces, required to be bent, is in as many different pieces as there are spokes in the wheel segments, being placed between the spokes, held in position by the malleable crown castings, in which the spoke is seated, with a flat end, thereby doing away with the spokes splitting rims, and joints breaking down after being in use a short time, particularly in the case of wheels for heavy vehicles.

The wheel cannot become smaller and the tire loosen, or the shoulders broken down. This new idea in rim making does away with the necessity of re-setting tires, there are no breaking tenons to contend with, no split rims even in the hottest weather; tires are always tight, no flattening where rims join, no creaking as a result of wheels becoming dry, felloes do not mash on spoke shoulders thus causing loose tires, and it does away with all holes in rims, which weaken them. The Sarven buggy wheels have 64 tenon holes, 32 tire bolt holes, and 128 felloe screw or rivet holes, a total of 224.

Under this plan wheels can be manufactured without bent rims or sawed felloes. It does away with tire bolts, felloe plates, rim screw or rivets. Spokes are cut off square, and no tenon required. Malleable segments are driven on each spoke end, and segments driven between crown. After shrinking tires on, the tire presses the crowns tightly on the spoke ends, and there is no end-wise shrinking of the spokes.

WE PASS IT ALONG

A firm of advertising agents holding forth in Philadelphia and several elsewhere, thinks the sentiment proposed by the head of a big hardware jobbery to its salesman is a fine quality of glue for the kind of business backbone that needs bracing. It is asking that all hands publish. Oh, very well, here it is:

"Don't Worry

"War or no war, freight rates or no freight rates, tariff or no tariff, baseball or no baseball, grape juice or champagne—the farmer is still on the job.

"Don't Forget Him"

HARNESS MANUFACTURERS TO MEET IN 'FRISCO

The W. S. A. and other national bodies in the harness wholesale trade will meet in San Francisco in 1915. It was so decided at the Chicago convention just closed.

FOREIGN TRADE NOTES**Motor Trucks in India**

Business circles in India are manifesting increasing interest in the possibility of making extensive use of motor trucks for purposes of commercial transport over short distances where slow-going bullock carts are now mostly used.

Although it has been a common belief in India that the bullock-cart mode of transport is the cheapest possible under the circumstances, yet lately experiments with motor trucks have shown that motor transport is really a much cheaper means of meeting the necessities of trade. For instance, in Bombay, where a vast amount of cotton has to be handled every year, it is a common sight to see on the streets a string of about 30 bullock carts, each drawn by two oxen and loaded with three or four bales of cotton. Taking four bales as a maximum load, it is obvious that it requires 30 men, 30 carts and 60 bullocks to remove 120 bales of cotton, and it takes them one hour to cover three miles, the approximate cost being \$9.73 for the trip. The same number of bales could be carried in five motor lorries, at a cost of \$1.60 per car, or \$8 in all, and the time occupied would be 15 minutes. Besides this saving in time and in cost of transport, there also would be a great saving in wages. Allowing a driver and one assistant for each commercial motor vehicle, it would be necessary to pay the wages of only ten men for a quarter of an hour, instead of 30 men for a full hour, thus adding at least another \$1.60 to the economic advantage possessed by the motor vehicle over the bullock cart for transport purposes.

Moreover it is now recognized that in India there is a great field for motor transport in connection with railways. There are many small towns in India where the cost of laying down a railway is out of all proportion to the immediate return that is likely to be received for the expenditure. For distances up to 100 miles, and loads up to five tons, it can easily be seen that an enormous economy in time and in expenditure would result from the use of motor traction. The units being so much smaller than those of a freight train, there would be a minimum of difficulty in regularly finding full loads for the vehicles, and a properly organized system could be so arranged that the running of unladen vehicles on the return journey would be reduced to a minimum. In this connection an economic conference, which was held in the state of Mysore last June under the auspices of the government of this progressive native state, passed a resolution declaring that it may be possible to introduce motor services for passengers and goods on some of the important routes in the state.

In response to this resolution, the director of industries and commerce prepared a bulletin on the subject. This bulletin gives a list of some of the more promising routes on which motor cars might be experimentally tried, and also suggests several branch railways which might be operated in conjunction with a motor-car service.

Use of Trucks in Bombay

One leading motor car company in Bombay has lately been introducing commercial motor cars for a variety of purposes. These cars have been fitted with large tanks for the conveyance of oil, gasoline, water, etc. In addition to carrying goods, they have also been used as fire engines, omnibuses, etc. This firm has supplied a fleet of motor vans for the Ameer of Afghanistan.

A prospectus has just been issued of another motor car company, the main object of which is to purchase and maintain a fleet of motor lorries suitable for carting large quantities of cotton and other merchandise to and from the docks to the various cotton mills and other works situated in the surrounding districts of Bombay city. It is intended to maintain a fleet of 20 to 25 motor lorries fitted with solid rubber tires. A

site has been purchased for a garage, and a workshop is already in course of erection.

Motor vans are being increasingly used by the health department of Bombay for disposing of city refuse.

Motor Trucks in Calcutta

In the city of Calcutta the movement in favor of commercial motor cars also appears to be gaining considerable headway. The Englishman of that city notes:

There are now a fairly large number of motor lorries used for transport business in Calcutta, and there is every prospect of a further increase in their number. From the point of view of speed, of course the bullock cart is not in it with the motor lorry and, according to expert calculation, even the question of cost is not so prohibitive a factor in the employment of mechanical traction when its advantages are also placed in the balance, as was believed at one time. Motor traction is only a trifle dearer than bullock traction, but the difference is more than made up by quickness and less risk of loss of goods by the new method of transportation."

A company is also now organized at Calcutta for the commercial transport business. The manager has recently been visiting London, Paris, Berlin, and other cities of Europe, in order to become informed as to the best European methods of successfully conducting a business in the operation of commercial motors. (The names of this company and its manager may be obtained from the Bureau of Foreign and Domestic Commerce.)

Australia's Purchases of Motor Vehicles

At the request of the Motor Traders' Association of New South Wales the Federal Department of Trade and Customs has compiled a return of motor-vehicle importations into Australia for the calendar year 1913. A comparison with similar figures for 1912 shows a falling off in chassis imports of 8 per cent., the amounts expended for the respective years being: 1912, \$7,063,700; 1913, \$6,489,722. Every state with the exception of Tasmania (which gained 32 per cent.) lost ground in chassis importations during the year under review. Body imports also declined, the decrease in 1913 as compared with 1912 being \$43,488, or about 4 per cent.

The combined chassis imports from the United States and Canada substantially exceeded those from the United Kingdom. This is the first time on record that this has happened, and denotes the great demand for the cheap, light car, to which the American and Canadian manufacturers pay special attention. Germany and Switzerland were the only other countries to gain ground.

New Automobile Regulations in Province of Quebec

Despite the rather unfavorable condition of roads in and around this city, the number of automobiles has greatly increased during the last few years.

Automobile owners here have now a regular organization which has already done much to stimulate the interest of the Provincial Government in its public roads, with the result that considerable money will be expended for their improvement this season. Their condition has seriously hampered the use of motor cars. American tourists especially have felt these inconveniences on their trips from the New England states to this city, and their diminishing number has suggested the need of road improvements throughout the province. It is estimated that there will be 475 to 500 cars in this city and immediate vicinity this year, an increase of about 200 cars over last year.

As a consequence of this rapid growth, it has been found desirable to enact amendatory legislation. Quebec has many very narrow streets, with barely sufficient room for vehicles to pass a moving street car, and these regulations are expected to prevent many accidents and loss of life likely to occur with the fast increasing use of motor vehicles run at a speed which, however, has caused few accidents and deaths so far.

MEETING OF VEHICLE LEAGUE REPORTED BY SECRETARY H. A. WHITE

The annual meeting of the Vehicle League was held at Charlotte, N. C., June 12, 1914, Mecklenburg Hotel. Though the hot wave and previous engagements kept several members away, there was a majority represented, and, measured by enthusiasm, showed this was a great meeting.

President George Hackney, of Wilson, N. C., whose family history for three generations has been linked with the vehicle industry of this country, in his opening speech gave a brief outline of the many varied and direct benefits received in the co-operation of carriage builders through the medium of The Vehicle League, a veritable clearing house for the difficulties connected with the industry. The proper solution of these difficulties result in inestimable benefit to dealer and manufacturer alike.

This movement for the conservation of our mutual interests has "struck bottom," and through the system adopted and in such successful operation for the past year, we have been able to take new hope and the future looks most promising.

The condition of the treasury as indicated by the report of the secretary and treasurer, is in fine shape, and everything in this regard moving along nicely.

Among the various topics of interest the most important, perhaps, was the decision to broaden out the organization and open the door for the participation of wholesale wagon and harness manufacturers, whose interests are identical with ours in the matter of safeguarding credits and improving generally the standing of the horse-drawn vehicle industry.

A spontaneous symposium of a dozen off-hand, three-minute talks by experienced business men present showed without the shadow of a doubt that this league is no "flash in the pan."

The definite benefits named by one man after another as being received through the league was very inspiring and all gathered new enthusiasm. The daily operation of the credit bureau was highly commended, and the continuance of the same went through without a dissenting voice.

The old officers were re-elected for another year, as well as the governing board, with the substitution of B. M. Blount, of Atlanta, in place of Chas. Pratt, Owensboro, Ky., who has retired from the vehicle industry.

A resolution of thanks was given the officers for conscientious services rendered.

A delightful luncheon was served in the assembly room, where also was on display the government exhibit of plates, specifications, catalogs, etc., of foreign made vehicles, and collection of consular reports on the vehicle industry from various countries.

The meeting was profitable and the feeling that this occasion marked but the first milestone on the high road toward the betterment of the vehicle industry in the south was general.

Six states are associated in the league: Virginia, North Carolina, South Carolina, Georgia, Alabama and Ohio.

Two meetings, in June and November, are held annually, the summer session in Charlotte and the winter meeting at such place as the association may select.

Any manufacturers interested in the Vehicle League are requested to correspond with C. P. Heindel, Commissioner, Commercial National Bank Building, Charlotte, N. C.

MOTOR CARS IN SOUTH AFRICA

It is probable that South African motor car importations during 1913 exceeded those of any other country in proportion to the population.

There are several reasons which may be held accountable for the popularity of motor vehicles. (1) Towns are not close together, and in the case of adjoining farms the homesteads may be several miles apart. (2) South Africans are sportsmen to the core. (3) Every town of importance has its golf links,

cricket and football grounds, tennis courts, bowling green, and rifle range. (4) The motor car is decidedly popular as a means of conveyance to and from the grounds. (5) The motor taxi is rapidly superseding the horse-drawn vehicle as a public conveyance in all towns of any size. (6) The agricultural shows of this year afford ample evidence of the popularity of the motor car with the farmer and gave practical demonstrations of the extent to which he relies upon this method of transport. (7) In the towns the motor car is rapidly supplanting the horse for pleasure riding and is beginning to be used for commercial purposes.

Road Conditions—Classes of Cars Used

Considering the comparatively sparse population the roads are fairly good and are being steadily improved. The country is naturally rugged, with many hills and drifts (stream crossings without bridges) and a considerable proportion of sandy roads. In other places the roads are very rocky, so that taken all together a good clearance (at least 10 inches) is a necessity. In the towns the roads are usually of crushed rock and reasonably good.

The medium to low priced American cars are decidedly the most popular and most readily sold. Much less is heard about the cheap American car at this time than formerly. They have been thoroughly tried out and apparently have been found satisfactory.

Outside the medium-priced article American cars have as yet been little used in this district. The idea still prevails that if a car costing \$2,500 or more is desired the European car is superior to the American product. It is difficult to account for this, inasmuch as none of the high-priced American cars have ever been sold in the district. Undoubtedly they will come eventually, but that time has not yet arrived, nor are the conditions at present particularly favorable.

Business Conditions—Imports

South Africa is at present in an unsatisfactory position from a purely commercial standpoint. Two severe droughts in succession, coupled with serious labor disturbances and the slump in the ostrich feather market, are responsible for the present trade depression. How long these conditions will continue is a matter of conjecture. The fact that in the large commercial houses business interests are anything but optimistic should be sufficient information as to prospects for the immediate future.

The magnitude of the motor car trade in South African is shown by the importations for 1913, when the total imports of cars and parts totaled \$5,400,000.

PRODUCTION OF PLATINUM

Platinum is now worth \$46 an ounce, against \$20 five years ago. Increased prospecting last year in the United States, however, resulted in a total output of only 721 ounces of crude metal.

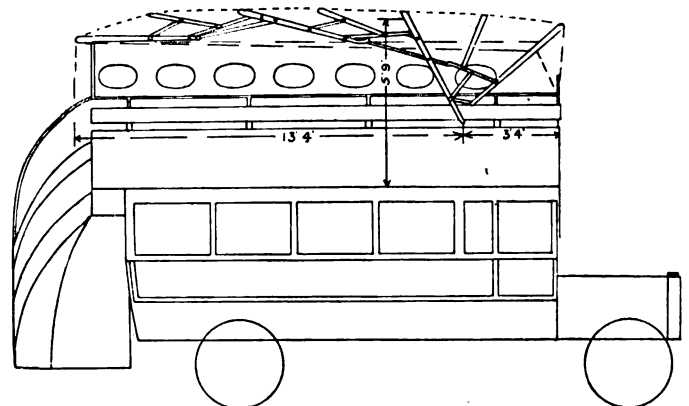

Public Bus Hood—An English Idea

THE MONO-TRACK (GYROSCOPE) CAR

Pierre Schilowsky, a Russian inventor, sprang a surprise on Londoners, says *The Motor*, when, without preliminary, he took a seat beside the motorman of his two-wheeled gyrocar and proceeded on low speed at four miles an hour from the garage, demonstrating that this vehicle of great overall length and weight is not only self-stable so long as the motor is working to deliver power to a dynamo, whence it is passed to the gyroscope, but also that at the rate of speed specified it can be turned in the comparatively small compass of a London square, and can be handled in thronged traffic.

The inventor called a halt, and with the engine running light, the gyroscope was kept working, so that there was no necessity to apply a sort of brake lever that let down roller-tipped skids for keeping the two-wheeled gyrocar in an upright position when in the garage and with the mechanism at rest. The two wheels traverse a single track, the front one being set centrally in front of the engine bonnet for all the world as if you had placed a giant safety bicycle fork in front of a motor car. The weight of the gyroscope does not exceed 10 per cent. of the total weight of the vehicle, a maximum of not more than $1\frac{1}{4}$ h.p. is required to work it, and the rate of revolution necessary for efficiency is proportionately slow, namely, from 1,200 to 1,500 turns a minute. The special point about the inventor's system of employing the gyroscope principle is that automatic means are provided of moving the gyroscope on its axis as it turns on ball bearings and for hastening the number of turns momentarily by the action of dual pendulums, one on each side of the front seats, which on the slightest deviation of the balance of the gyrocar from a dead-even keel come into engagement with a ratchet device, which is the means of actuating the mechanism for accelerating the gyroscope and moving its axis, a slight click indicating that the spring for automatically disengaging the correct ratchet and pendulum at the right moment has done its work.

How efficient it is we learned from seeing the gyrocar stand upright in the street without any support, with the two wheels perfectly stationary, while people leaned against it and others stood on it, moving about at their convenience and jumping off suddenly as the fancy took them without upsetting the balance in any way that could be detected by the human eye, the feature of it being, therefore, that the car is laterally more stable than a four-wheeled vehicle, because you know that if a heavy man steps on to the running board of the most powerful car that is well sprung, he momentarily sets up a lateral oscillation.

On starting up the car again, Dr. Schilowsky directed it to be driven into Regent's Park, where he invented four passengers to make a tour of the outer circle with him.

"Having absolutely standard gears," he said, "you will understand that this is only what I will call a popular demonstration; but I am having gears of suitably calculated ratios made, and I expect them to be ready on my return from the Continent in ten days or a fortnight's time, when I will give you a demonstration of faster travel. If my car were designed for the single purpose of traveling along the road it would be a very much lighter machine, but I am handicapping my purpose by making this first full-scale gyrocar suitable for the road, with the solid rubber tires now on, and suitable for a single rail without the tires. We will now put the higher gear in service, and you will see that the motor cannot take it, for the car is losing speed, and if we persist the engine will stop. So we will drop back into the low speed, and you and the public shall therefore realize from this particular demonstration that when we are traveling at only four miles an hour we are no less steady than when standing still, therefore we depend absolutely on the gyroscope for our balance, and you see it is not failing us."

We progressed so smoothly as not to feel any vibration nor to hear any noise of the working of the mechanism. No six-cylinder car could be more silent. The luxury of the suspen-

sion in a longitudinal sense through the use of a sort of cantilever springing fore and aft made our progress perfectly smooth, while our single track caused us to be more absolutely immune from lateral oscillation than is the rider of a bicycle, because there was no necessity to incline the front wheel now this way, now that, to assist in any way in the preservation of balance sideways. When we came to make the only right-angle turn necessary in the park, we did it in comparatively small compass, the overall length of the vehicle considered; and the astonishing thing was to discover us making that turn with the gyrocar still on a dead-even keel as distinct from being heeled over as on a bicycle.

On entering the park, too, the vehicle had been advanced and reversed two or three times, standing stationary like a motor car between each operation and always in perfect balance. It was an odd experience to make a journey on what is admittedly an experimental machine of its kind and yet to enjoy such absolute luxury of progression and an entire absence of any feature of coarseness of performance or any hint of failure even for a moment in the working of the mechanism. The little ball that ticks when every hundred revolutions of the gyroscope are made reported all well from start to finish of our journey.

When the new gears are fitted, it will be particularly interesting to study the conduct of the gyrocar at the normal speeds of mechanical road vehicles, and especially to observe whether or not it is possible to negotiate corners and abrupt turns of the way with comparable ease and safety, allowance being made for the fact that this example scales very much more than the inventor deems necessary in the case of a pleasure car designed for road service and nothing else. The machine certainly marks a material stage of advance in gyrocar progress.

THE SUPERIORITY OF THE SUPERIOR GENT WHO IS HIMSELF "DOCUMENTE," THAT IS, HE'S AN EXHIBIT

The chap who translates for *The Automobile* writes to that journal to demonstrate that one who knows so very much, how very much one knows. He must be all nose.

The compiler of the *Engineering Digest* department desires to take distance from the article on *Methods of the French Designer*. This story is scarcely what the French call *documente*; that is, it does not carry intrinsic proof to the effect that the ideas expressed portray an actual condition rather than the theories of the author paraphrased as descriptive of rules practiced by others; in this case the whole French industry. But the ideas set forth—in some instances quaintly, as will be noticed—cover much ground and cover it rapidly. There is a certain Shakespearian flow in the loose diction imparting to the reader if he is interested in the subject, a sense of pleasure somewhat of the same order as that obtained in a different fashion from an automobile when its swift progress unrolls a succession of changing landscape. This effect of fullness brimming over is fortunately somewhat marred by the vagueness of the ideas. There is, so to say, a mist over the landscape.

Defends American Quality

The statement that "in American practice quantity took precedence over quality" seems unjust, though it is qualified by the author afterwards. In point of fact, American practice—meaning that of leading factories—has developed a method for incorporating a very acceptable degree of accuracy with large and rapid production, and this development has eliminated the undesirable and uncontrollable personal element very largely from the guarantees of accuracy, which means that an accuracy of a new and better sort was created here, one making replacements without special fitting possible for the first time in the world's industrial history.

That the courage to enter upon this new path for fine machinery was perhaps borrowed from successes of the same sort

previously accomplished in the sewing machine and the stove industries does not matter or alter the facts.

Not for a moment should it be admitted, if only to be withdrawn or qualified in doubtful terms, that American practice in automobile construction has not done far more than any other practice, French, German, or British, to raise the conception of industrial accuracy for automobiles to a higher and more sensible plane.

SAWS

Saws are sometimes wise sayings, and sometimes these sayings cut just as sharply as the real saw, but the genuine hand saws about which we are writing are very interesting, and the Blacksmith and Wheelwright has found something somewhere about saws that it reprints, and we follow suit.

Hand saws are made of three different kinds of material, sheet iron, shear steel, and cast steel. Those of the better quality are of the last mentioned kind, and will serve to exemplify the others. Ingots of cast steel are first rolled or milled into sheets having the proper thickness for saws, and these sheets are cut up into strips by means of a machine, which is, in fact, a pair of shears mounted on a frame. The cut edges are made smooth by applying them to a grindstone, and one of the edges is then provided with the teeth, which gives it the character of a saw. This is effected by a kind of punching. There is a small press, having a triangular punch at its lower extremity. A man holds the saw beneath it, and by the action of his right hand, brings down the punch forcibly on the surface of the steel, cutting out a little piece equal to the intended size of the teeth. He then moves the saw a little, and makes a second tooth in a similar way, proceeding thus from end to end of the saw with great quickness. The size and form of the punch depend on the kind of tooth to be made, and vary greatly in different instances.

After the teeth are cut the saws are hardened by being heated in a kiln or oven, and suddenly cooled by being plunged into a tank of oil. They are then slightly heated again, and while yet warm they are hammered at various parts, to remove any crookedness which the previous process may have given them. Next they are rested on a polished steel anvil, and hammered repeatedly over every part, by which the substance of the steel is made uniformly dense, even, and regular.

Then comes the grinding. This consists in attaching the saw to a flat board, and applying it to the edge of a grindstone, so as to grind off all roughness, and make the saw perfectly flat. The manner in which this is done is remarkable, since the workman seems to be in imminent danger of being precipitated over the wheel or falling on it while rapidly revolving.

Another hammering is required to remove the twisting caused by the grinding, and another beating to restore the temper. Another but very slight grinding is given to remove the hammer marks, after which the set is given to the teeth; that is, the lateral bending which every tooth of a saw presents.

The workman rests the saw flat on a smooth anvil, and by means of a small hammer held in the right hand, he gives a blow to every alternate tooth, thereby bending it out of the straight line. He then turns the saw over, and strikes all the other teeth, so that every other tooth may be bent in a different direction.

ELECTRIC CAR CONVENTIONS IN BOSTON

The second annual convention of the New England section of the Electric Vehicle Association of America and the Electric Motor Car Club of America ended at Bass Point (Boston) where a banquet was served to the delegates.

The convention opened at the American House when the Electric Vehicle Co. had a dinner at which Fred A. Hortter, of the Boston & Maine Railroad, delivered a paper on "The Effect of the Motor Truck on Terminal Freight Congestion." There

were many members of the Chamber of Commerce present, and the delegates to the electric convention who were in Boston also attended.

President Day Baker, of the Electric Motor Car Club, and President J. A. Hunnewell, of the New England section of the Electric Vehicle Association, alternated in presiding over the convention. It was held in the Engineers' Club on Commonwealth avenue. Ex-president W. H. Blood, Jr., of the national association, was the first speaker and his topic was "Co-operation." He was followed by Hayden Eames, of the Standard Electric Co., whose subject was "Recognition of the Electric." A. Jackson Marshall spoke on "The Electric Vehicle Association of America," and A. C. Faeh, of the Rauch & Lang Co., followed with a paper on "What Constitutes a Good Electric." E. J. Bartlett, of the Baker Electric Motor Vehicle Co., then spoke on "Utility of the Electric Vehicle, Pleasure and Commercial."

When these papers were read and discussed the session adjourned and the delegates were taken to the new service station of the Edison Electric Co. on Massachusetts avenue, Roxbury. An inspection was made of the big plant and a beefsteak dinner was served. The evening session was held there. The speakers were J. C. Bartlett, of the Bartlett Garage, Philadelphia, who talked on "Garaging and Service"; Prof. H. S. Thompson, of the Massachusetts Institute of Technology, on "The Relative Fields of Electric, Gasoline and Horse Trucks," and J. S. Codman, of the S. R. Bailey Co., Amesbury, Mass., "Touring by Electric Automobiles."

CINCINNATI CARRIAGE MAKERS OUTING

The Cincinnati Carriage Makers' Club annual outing was a gala event, with the usual pleasant river ride and picnic features.

With the pleasant memory of visits in years gone by, the pretty little town of New Richmond, O., was the destination of the journey, via the river.

About 130 members and guests were on board the good steamer Kentucky when she left Cincinnati, about noon Saturday, June 13, 1914.

It was a perfect day for the outing and all those who were privileged to attend took good advantage of the opportunity. One of the big features of the day was the baseball contest. The carriage builders, called the "Federals," were led by C. F. Egolf, while the accessories, known as the "Nationals," were captained by B. L. Craig. Of course, someone had to lose, and the Federals went down to defeat after five long weird innings, filled with plenty of fireworks and several balloon ascensions. Scores of the game were started but never finished. Whatever the result, it was supposed to be in favor of the supply men, but very close.

A fine big dinner was served in the open under the shady trees. Chicken, ice cream and strawberries, and other good things rapidly disappeared. After filling the inner man with the good eats, a little flow of reason and soul followed, President W. J. Brunsman calling upon a number present to uncork a little oratory. Chas. F. Pratt, Ed. Sendelbach and a number of other spellbinders put the finishing touches to the occasion.

There were a number of athletic events, such as shot putting, fat men's race, one for the thin ones, 50 yard dashes. All were extremely thrilling.

It was another one of those big days to add to the chain of past events that characterizes the annual outings of the Cincinnati Carriage Makers' Club, and to which the members look forward from year to year with pleasant anticipations.

WHY NOT CALL IT BY ITS REAL NAME

"It has been frequently said that one of the worst features of the automobile business has been the over-zealousness of both the manufacturer and salesman, claiming too much for their cars and making wild statements."

REASONS FOR FRONT WHEEL BRAKES

At present there are only two well known makes of car in Europe fitted with front wheel braking, although a few years ago quite a number were using them.

To obtain efficient front braking requires careful study and experiment, if interference with steering is to be avoided. Many designers who tried it considered that all they had to do was to add brake drums to the front wheels. The result was that with the slightest slackness in the steering pivots and tie-rod pins the wheels endeavored to run wide or run together when the brakes were applied according as the tie-rod was in front or behind the axle. Also if one brake came on before the other the steering was deflected in that direction according to the amount of backlash in the steering gear and connections.

The first point that has to be recognized in front-wheel braking is that the equivalent of center-point steering must be attained before satisfaction can be expected. Few steering lay-outs, either then or now, have not some overhang of the wheels, and so long as there is any semblance of overhang there must be some interference of the braking on the steering. The idea is to place the steering pivot and the brake drum in the center of the wheel, but the detachable wheel does not lend itself to this arrangement, and after all the same result can be attained by canting the pivots or the wheels or both.

If the pivots are inclined, the steering tends to be self-recovering, because turning the front wheels lifts the axle one side or the other, and the weight of the chassis naturally tends to bring the wheels back to the straight. Such a design, apart from lending itself to braking, makes the best steering arrangement, because the wheels try to keep track of their own accord, and so put little strain on the steering connections, and continue to run straight even after slack has developed.

Front braking, therefore, if properly tackled, actually makes for a better steering car, but there is another question not so easy of solution, and that is how the brakes should be operated. The easiest way is to connect them up to the pedal or the side lever, and this is what was done in practically all the earlier arrangements.

But in so doing an advantage is not taken that is well worth having. If a car is on a cambered road and the rear wheels locked, the back of the car slides down the camber. If, on the other hand, the front wheels are locked it is the bonnet end that tends to slide gutterwards. That is, in the one case the car turns one way and in the second case the other. Lock all four wheels, therefore, and the car will not tend to turn either way but to slide forward in the direction of motion. If there is a sideways slide the car will still keep its direction, and not pivoting on either pair of wheels there is maximum resistance, tending to stop the slide.

Thus, in theory, four-wheel braking makes for much greater safety on treacherous surfaces, and this safety, under adverse conditions, is also obtained in practice. Unfortunately, we have at present but one example of a car so braked, so that observation is limited.

If all wheels are locked, we have seen that the car slides forward in a straight line, but it may be argued that this would in itself be dangerous should it be necessary to change the direction of the car at the moment the wheels are locked. Against this there is the fact that the maximum braking effort is no longer limited to the adhesion between rear wheels and road, but only by the total adhesion of all four wheels. As when braking, the weight of the car is thrown forward by inertia, the front wheel adhesion may actually be greater than the back, so that it can safely be asserted that front wheel brakes double the adhesion, and so double the maximum brake power that can be effectively used, which in turn halves the distance in which the car can be brought to a stop.

Even if the brake surfaces and leverages are designed so that locking of the wheels under ordinary conditions of road surface is unlikely, there should still be a very appreciable gain

in stopping power over any system or systems confined to a single pair of wheels.

It must, of course, be admitted that no single system can equal the efficiency of a well designed gearbox brake with its comparatively high-speed drum, but many of the world's leading makers are now abandoning this form of brake in order to reduce strain on the transmission, and pinning their faith to double brakes on the rear wheel drums. Now, clearly there must be an advantage in taking away one set of brakes and applying it to the front wheels, provided that each set is then given something approaching the power that the two sets on the one wheel possessed.

The accurate carrying out of braking tests is not in the ordinary way an easy matter, for there are so many varying conditions to be taken into account before anything like a useful comparison can be made. There is, however, an instrument that does allow comparisons to be made, and that is the accelerometer, the best known, and perhaps the most convenient in use.

A series of tests of various braking systems made by the aid of this device would, the writer in The Motor thinks, be of great value and interest, and also settle some doubtful points. This instrument has not to be connected up to the car in any way, but only to be levelled up on the floor of the car, when the needle will give the brake power applied in pounds per ton and also the gradient on which that brake pressure will hold the car. Of course, the uses of this clever and simple instrument are not confined to brake tests, but it also gives tractive resistance, acceleration, and hill-climbing power on each gear, the latter being obtainable on the level if desired.

THE COMPOSITE OF IT

The commercial truck that fell down so spectacularly the winter last past has had its features made into a composite by

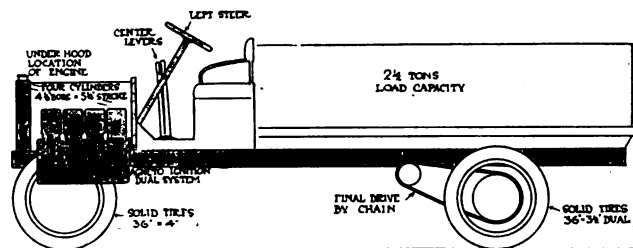

The Automobile, and they are here presented for those who like to take facts in tabloid form.

THE PRESSURE ON TIRES

Irrespective of the advantages due to cooler running of the large compared with the small tire there is the important item of less internal strain. The increase of pressure is continually going on throughout the life of the tire, acting like dripping water on a stone, and eventually causing a burst. Probably 90 per cent. of motor tires burst when traveling. This, of course, is due to the sudden increase of pressure, and could a tire be made large enough to keep the pressure absolutely constant (an impossibility), there would be no more likelihood of a tire bursting when traveling than when remaining stationary. We know full well from experience what will happen if we use a tire that is too small to bear the weight of the car. The increase of pressure will be greater than the tire can manage, and a burst will be the result. On this question it is interesting to note that the weight of the car is immaterial so long as it is tired in proportion to its weight.

A tire of correct proportions fitted to a car weighing, say, five tons will last as long as a smaller tire fitted (likewise fitted in proportion, inflated to same pressure) to a car weighing 1,800 lbs.

Not that the small tire may be built of lighter material than

the large, but because the increase in pressure in both cases will be the same if the tires are fitted in proportion to the weights.

This seemingly astounding statement is borne out by the fact that a tire is built not to support the weight of the car above it, but merely to hold the pressure contained in it.

Of course from a constructional standpoint it must be remembered that the small tire would be stronger than the large one, owing to the fact that a tube of small bore can withstand a greater pressure than a large one, but the example given is merely dealing with the air in the tire and not from the constructional standpoint.

Let us examine for a moment what effect rise in pressure has on the tire as a whole.

Assume a 90 mm. tire encounters an obstacle of sufficient size to deform the tire 100th part of its original volume, or, in other words, flattens the tire so that the air is squeezed into 99/100ths of its original capacity. If the tire was originally inflated to 80 lbs. pressure per square inch, the pressure is now raised to approximately 81 lbs. per sq. in., which gives an increase of 1 lb. per sq. in. Estimating the number of square inches in an 810 by 90 tire as, roughly, 1,000, and we get a total strain put on the of 1,000 lbs., or nearly half a ton every time the tire is deformed 100th of its original volume. Similarly, the deformation of 1/200th of its original volume (a few ounces per sq. in.) will produce a total increased strain of a quarter of a ton, and 1/50th of its original volume the enormous strain of nearly a ton.

It will be seen, therefore, that however slight the amount of deformation the total increased strain on the tire is very great, and little wonder that the success of achieving 100 miles in the hour (when the deformation is great, due to the momentum of the car) depends solely on whether the tires can withstand the enormous strain (probably several tons increase several times per second) to which they are subjected.

THE VALUE OF FARM MACHINERY

"In these days of much talk about the high cost of living we are confronted by a startling truth: that if it were not for farm machinery we could not live at all. If we had no farm machinery our great cities, centers of industry and wealth, would shrivel and disappear. Instead of having 40 per cent. of our population in cities, as is the case today, there would be only 3 or 4 per cent. of the people who could afford to be urban dwellers. And the other 96 or 97 per cent. would be mighty busy trying to wrest a living for themselves and their city brethren out of the soil."

Well, what of it? Suppose 96 per cent. were "trying to wrest a living for themselves out of the soil." There would be fewer middlemen living on coin clippings, fewer I. W. W.'s, and fewer in cities who ought not to be there—and more in the country to whom to sell buggies.

Think before writing, and don't be a special pleader all the time. There are others besides plow makers.

JUST A COUPLE OF "LOCALS"

Carney & Long, buggy dealers, are enjoying an unprecedented trade; in fact, larger than they had ever anticipated. They have sold 300 buggies since the season opened, the sales being made in a radius of 40 miles of Mayfield. On last Saturday 23 buggies were sold, and prospects are flattering for an exceptionally good week.—Mayfield Messenger.

The man who believes that automobiles are driving the buggy and road horse out of the country ought to have been in town at the band concert last Saturday night. The glistening of new buggies could be seen all round the square. Dealers are selling them by the carload. The boys declare a motor is no good to go to see a girl with. It costs too much; it stops when it

should not; sometimes it makes too much noise and the folks know just when you drive up to the girl's home. So they are as yet preferring the buggy for courting. The boys say the motor car has other faults, such as requiring two hands to drive.—Nebraska Farm Journal.

A NEW TUFTING WASHER DESCRIBED

It is a tin tufting washer for use with metal shank tufting buttons. The washer has been designed by a Cincinnati steel and iron concern in its shops to overcome the difficulties that were formerly met by the trade with the old tin washers. The original tin tufting washer was about the size of the inner portion of this new one so that in the new, washer manufacturers have exactly the same shape for the tufted portion that was in the old one. To this has been added a wider rim which gives a broad bearing surface on the canvas, and edge turned up so that the rough cutting of the tin may not mar or damage the fabric and cause it to break through. An extra corrugation in the base stiffens it as a support or bridge, thereby making the washer very strong and preventing buckling or coiling up.

Samples have been submitted to the trade; they pronounce it the best thing in the tufting washer line that has been produced, and above all, it is as cheap, or cheaper, than the little old tin washer which it so far excels in quality.

TAXIS FOR TWO BITS A MILE

A cyclecar taxicab, which will carry two passengers besides the driver, will sell for \$600 and will be operated at 25 cents for the first mile and 5 cents a quarter-mile thereafter, is to be built by the Twombly Taxicab Co., which has been incorporated in New York state with a capitalization of \$500,000. The enterprise is planned by the builder of the Twombly cyclecar.

A radical feature of the enterprise is a clause in the selling contract which provides that the cabs must be operated at a fare not to exceed 25 cents for the first mile and 5 cents a quarter-mile thereafter.

Twombly states that 1,000 cabs already have been spoken for for operation in New York, Boston and Philadelphia, and that this number will be turned out between October 1 and February 1. The first cabs will be soon completed.

As to the cab itself, it will have a 44-in. tread; 92-in. wheel-base; a four-cylinder water cooled motor, 2¾ x 4; an improved landaulet body, and provision for carrying as much baggage as can be carried on the average taxicab.

THE ENTERPRISING VEHICLE MAN

On April 20 last it was pointed out by the Pall Mall Gazette that the 150th anniversary of the birth of Rudolph Ackermann had been reached, to whom we owe the general introduction into England of lithography nearly a century ago, though the art had become slightly known in England soon after Senefeld-er's work. Ackermann was a German who settled in London as a coach designer, but he abandoned this trade and opened a print shop in the Strand, patented a waterproofing method, and established the lithographic art. We presume this is the same Ackermann who invented the pivoted axle arm.

FOLDING SEATS FOR TAXICABS

Berlin (Germany) supplies more comfort and advantage in its taxi cabs than can be found hereabouts. Consider the extra seat. There are two seats side by side. The back flaps down on to the seat, and the right-angle structure which is then left folds neatly away into the corner which is made between floor and front pillars. The frames of the stay and support are of metal filled in with wood.

ABOLISHING THE DIFFERENTIAL

When the late James Starley, in the early days of the tricycle, close on 35 years ago, invented the differential geared axle, he was unaware that a similar device for a similar object had already been in use for some time upon traction engines. That it has since been adopted universally through all the intermediate ranges shows the appreciation in which it has been held by designers. But, like the long-threatened but still prevailing sliding type of gear (that "truly barbarous system," as it has frequently and truly been designated), the differential has always been acknowledged to have its defects, the principal of these being, of course, that, theoretically, it "drives the wrong wheel." In other words, it drives the wheel which has the least resistance, the other acting as a fulcrum for that purpose. The result is that in really "tight" places, such as one wheel getting in a hole, or in deep sand, or loose earth, which often happens in roadless places, the vehicle is unable to pull itself out, owing to the action of the differential using the "bogged" wheel as a point of resistance and simply "spinning" the other over the surface, as it lacks sufficient weight upon it to give it enough tractive force; while in motor cars on good surfaces the same action will often result in spinning one wheel over the ground surface—and wearing out the tire—when starting on a sloping road, which throws more weight on one wheel than upon the other.

On the other hand, in that it automatically drives the outer wheel when on a curve, it is theoretically perfect from this point of view, under average road conditions, and it is largely because the roads upon which automobiles are used are for the most part good and conditions unexact that this feature of its action has carried more weight than the defect. The ideal—apparently unattainable—would be that it should drive the outer wheel on a curve and also apply the greater power to the wheel encountering the greater resistance. The factors ruling action in these two desiderata are contradictory. Of late, in so far as the motor car is concerned, a tendency has shown itself to eliminate the differential altogether, because another factor has come into operation which was inconsiderable in the case of the traction engine and the pedal-propelled tricycle—to-wit, speed.

It is recognized that the differential absorbs power, especially when turning sharp corners under heavy load, as when rounding curves on steep hills, and it is also recognized that it is not altogether a cheap construction to produce, and adds substantially to cost of manufacture, complication and weight, and as all these three points are receiving more and more consideration, the abolition of the differential becomes a matter of more than passing thought, it is written in *The Motor* (England).

The makers of Sunbeam car have shown that the differential is of little use in racing cars, for in their most successful constructions for this purpose they have abandoned it altogether, simply driving both wheels fixed on the ends of a shaft. At first sight the fear presents itself that with such a construction there would be difficulty in steering, and steering at speed is a delicate question, and also that there would be undue tire wear. But it is here that the new factor of speed comes in. With a traction engine or other slow-moving vehicle, having both wheels fast and a heavy weight upon them, it becomes a contest between the front and back axles as to the way the vehicle should go. If the weight upon the steering wheels is sufficient, the "pull" on the direction induced by their movement will be greater than the tractive grip of the driving wheels, and one or other of them, or both, will slip in their relation with the ground surface, and the driving wheels will follow the others; but, where steering weight is insufficient, the driving wheels will simply continue on their forward course, and the steering wheels will be pushed diagonally over the ground without any effect on the course of the machine. It will also be readily recognized that the work of the steersman will always be hard. Here we have the combination of considerable weight

with slow speed. On the racing automobile we have light weight and high speed, and we have a larger proportion of the weight on the steering wheels.

Different From Tractors

Instead of the driving wheels being held down by great weight they are lightly loaded, and, under the action of speed, when they strike an inequality or an extra resistance, they simply leave the ground and bound out of contact with it. With either driving wheel off the ground, all further resistance to the action of the steering wheel ceases, and so, instead of having to be dragged round into a fresh line of direction, the back wheels simply progress in a series of leaps, one or other of them being about as much off the ground as on it, all the time; so that there is practically no serious resistance to the steering movement at any time. As regards the effect of this action upon tire wear, if this is looked into it will be seen that under these conditions of driving the tires are really subjected to less stress when there is no differential employed than with one. To appreciate the point, consider that the wheels will bound off the ground in any case when the car is traveling fast, differential or no differential—although it is quite possible that this bounding action may be slightly greater when there is no differential than when one is employed—and the action of the wheels and the effect upon the tires is quite different. Where a differential is employed, the moment one wheel leaves the ground the driving effect upon the other wheel is, for the moment, nullified, the force of the engine being devoted to spinning the wheel in the air at a higher rate of speed, both engine and wheel, in fact, "racing." Then, when the wheel comes to earth again, it is revolving at a much higher rate of speed than its fellow, and before it can take up its share of work, the resistances must be equalized, and the speed of the two wheels equalized also, with the result that, until this takes place, the surface of the tire is being violently scraped over the ground (the wheel comes to earth with a skidding action, in other words), whereas, when the two wheels are fast on the same shaft, when one leaves the ground the other is receiving the full force of the drive, there is no spinning and no skidding, as the wheel which is in the air being fast with the other on the end of the shaft, continues to revolve with it, and comes to ground again at exactly the same speed as the other, thus dropping into work again without any relative ground movement, and, consequently, without undue wear on tire surface.

Apt to Grow Conventional

After lapse of years we grow conventional. Innovation is looked upon with suspicion, and so revolutionary a proceeding as the abolition of the differential engender grave doubts; but it is really quite the correct thing when the conditions are considered, and the Sunbeam successes would appear to prove that it is so.

Apart from this example set by the racing Sunbeam, we have also had several instances of late in which the differential has been abolished in car construction when the vehicle has not been intended for high speed purposes. These instances have occurred in several of the new light cars of the class known as cyclecars. In this class of machine the aim of the constructor is lightness, simplicity and cheapness, and new lines are being followed in design, with a greater trend towards the practice of the motorcycle builder than towards that of the car manufacturer. What is aimed at is something which will get there in the simplest possible way and do its work, even if falling short of theoretical perfection in the doing of it, considered from a car standpoint. And the abolition of the differential has been one of the means adopted to arrive at simplicity.

In doing this, some manufacturers have simply driven a through shaft, with a wheel fast to either end. Some have interposed a friction clutch between the ends of the shaft and the wheels, so that on curves and corners one wheel would slip a little, and so obtain compensation for the difference in the distance traveled by the two wheels. In other words, they

have arranged to slip their wheels on the axle instead of over the road. Others have solved the problem by mounting one wheel loose upon the end of the shaft, and so leaving to one wheel only the whole task of driving the car.

That these unconventional constructions should prove satisfactory in use is interesting, and the information may be valuable as we pursue our course toward the production of the car of maximum simplicity, and the reason why these little vehicles have proved successful without differentials is largely due to their lightness and to the effect of the factor of speed. All these cyclecars are either single or double seated vehicles only. Their occupants are seated in the middle of the wheelbase, and the back wheels are lightly loaded. The tail ends of the machines are thus free to dance about somewhat, and much more free to bound on rough roads when traveling fast than if they were heavier and two more passengers were perched over the back wheels.

A Mechanical Monstrosity

As regards the question of using only a single wheel instead of two, when that wheel is not centrally placed, as in a double steering three-wheeler, there can be no question about its being a mechanical monstrosity; but, like the sliding gear, it certainly can be made to do. To see this in its most unmechanical form, we have but to look at the motorcycle with attached sidecar. Here we have both driving and steering wheels away on one side of the load, and the lateral drag on the tire is visually perceptible; yet the arrangement is being used in rapidly increasing numbers, and, in many cases, really extraordinary loads are being thus dragged along. Take, for example, a motor bicycle with a platform body sidecar standing out so far that the tread of the motor wheel and that of the side wheel meet nearly equal that of a car; this platform loaded up a couple of feet or more, three men perched on top. And yet it gets along all right. If a single wheel side drive will stand up and do practical service under such conditions, it would appear that even the single drive may practically serve the needs of those who are content to accept the means without criticism, and may be worth consideration in arriving at the ultimate minimum of simplicity and cost in car construction.

A NEW HEADLIGHT

A new type of motor car headlight has recently been invented by M. Canneval, a French engineer. As every person who has had occasion to make use of electric headlights is aware, the usual method of projecting the rays is by a silvered parabolic projector. While the power of reflection of these mirrors is very high when new, they have the decided disadvantages of being liable to oxidation and very easily scratched when cleaned.

The Canneval headlight consists of a circular stepped mirror composed of parabolic and annular elements combined with a mangin lens mirror. This stepped mirror has the advantage of not being subject to oxidation and of maintaining its high powers of reflection indefinitely. The mirror is made of very thin, silvered glass solidified by metallization. In order to get the necessary solidity, the first coating of silver must adhere much more closely to the glass than by the ordinary process, otherwise the differences of expansion of the glass and the metal which cover it would cause peeling and thereby weaken the whole structure. For this reason the silver deposit is made by the Canneval system dry and within a vacuum, the pressure of the current exceeding 60,000 volts. This high voltage is necessary in order to secure a perfect adherence of the metal, which actually penetrates into the pores of the glass. The circular stepped mirror to be operated on is placed under a globe; a vacuum is created, then a little hydrogen gas is introduced in order to prevent the oxidation of the silver. Finally, the current is switched on, this volatilizing the metal of the electrode, which becomes practically welded to the glass. This layer of silver is much more brilliant than the coating contained by the ordinary method. In order to obtain a complete

regularity of the deposit, the stepped mirror is mounted on a central pivot rotated electrically from outside the globe. It is claimed that the new Canneval headlight is much more powerful than any other lamp of equal diameter and similar source of light.

IMPROVED LOCOMOBILES

The 1915 Locomobiles are on display. The chief change in the Locomobile policy for this season is the dropping of the right drive models and incorporating many detail refinements and luxuries in a development of the streamline body. The entire line of cars is built on two chassis known as the Little Six 38 and the Big Six 48. The larger and heavier bodies are mounted on the larger chassis.

The chief refinement is to be found in the application of the Westinghouse starter which is used in connection with a control which is the product of the Locomobile engineers. As far as the drive is concerned the starter is operated by a push button making the starting operation as simple as switching on the headlights. In fact, all the electrical push buttons look alike, being placed in a vertical row on the dash and within reach of hand or foot. The starter button is the lowest of the vertical row. As soon as the starter button is pushed the electric motor is engaged with the flywheel by means of a solenoid and remains there until the button is allowed to return to its normal position.

CARRIAGE WINDOW FITTING

The Ideal window appliance can be applied to any car which is not fitted with any special window raising or securing appliance, whether the windows are frameless or not. The raising apparatus is attached to the inner side of the garnish rail, and is operated by a handle, the turning of which lifts or lowers the glass to any position desired. The glass can be dropped over the fenceplate as well as lifted, thus enabling the old pattern glass frame, with its special wide run, to be utilized. Another important point is that the glass frame drops level with the fence-rail, just as in the ordinary brougham or landau.

Yet another point is the facility with which the glass frame can be removed for inspection without disturbing the upholstery. It is an English device and patent.

MERCHANTS' ASSOCIATION YEAR BOOK

The Year Book for 1914 issued by The Merchants' Association of New York City, contains the following members who are affiliated with the trades served by this publication:

Automobiles—General Vehicle Co., Inc., Harrolds Motor Car Co., Motor Car Equipment Co., New York Sporting Goods Co., Nonpariel Horn Mfg. Co., Renault Selling Branch, Inc., Stevens & Co., Walter Motor Truck Co., The White Co., Winton Motor Car Co.

Carriages, Wagons and Materials—Crane & MacMahon, Inc., Curtis & von Bernuth Mfg. Co., Louis Dusenbury & Co., Inc., Warren M. Healey, The Laidlaw Co., Inc., S. Stroock & Co., Studebaker Bros. Co., Wm. Wiese & Co.

ELECTRIC VEHICLE MEN FUSE

For the purpose of spreading good fellowship and promoting sociability among those who are in any way connected with the manufacture or sale of electric vehicles, a new organization, known as the Electrolytes, has been formed in Chicago. The association is unique in that it is for purely pleasure purposes and is the only one of its kind connected with the electric vehicle industry. L. E. Wagner is president, the other officers being as follows: Otto Suttmueller, vice-president; M. E. Davis, secretary, and Paul Frank, treasurer. The secretary's office is located at 3612 So. Morgan street.

Paint Shop

PAINT BRUSHES

Bristle is the most essential material so far discovered for the making of practical paint brushes. It is a hog product, consisting of a horny substance; it is very elastic and has excellent wearing qualities. Bristle is a product of Russia, China, Germany and France. Russia produces the best quality on account of the extreme cold climate.

In most of the bristle producing countries hogs are raised for the bristle, and not for the meat. It is contrary to the custom of most of these natives to eat hog meat only in cases of war or famine. When hogs die they are stripped of the bristle and the carcasses are used for fertilizer. The hogs are kept in large woods, which are sometimes fenced in. They are obliged to feed themselves the same as wild beasts. When the temperature moderates they naturally rub themselves against the bark of trees, which causes all the loose hair to shed. These are gathered by the peasants when they are not occupied on their farms, who go about these woods gathering a few hairs here and there. These are kept in bags until a dealer comes around and buys them as so many pounds of bristle, irrespective of size and quality. He assort them according to the sizes and qualities, and ships them to the various markets, where they hold semiannual fairs, and they are purchased by the different brokers representing the different brush manufacturers. The market for Russia bristle is St. Petersburg and Leipsic. The market for China bristle is Manchuria.

There is quite a noticeable difference in the packing and handling of the Russian and China bristle. The Chinese make a much neater package by wrapping each bundle separately, whereas the Russians ship their bristle in unwrapped bundles, which makes a most untidy appearance.

Germany and France supply the industry with a soft grade of white and yellow bristle. The Germans are considered to be the best bristle dressers in the world, and are exceptionally successful as bleachers of bristle. It is generally understood that in these two countries the hogs are killed before they are given an opportunity to grow a crop of long bristle. This is done because the demand for the hog meat is greater and more profitable in these countries than in Russia or China. As nature provides the hog, it is natural that wherever the climate is the coldest the hog is provided with a heavier coat of hair, so you can readily imagine the most durable bristle comes from Siberia.

Ninety per cent. of the black bristle used for the manufacture of brushes is supplied in China. The other 10 per cent. comes from Russia. The 10 per cent. which we get from Russia is very superior in quality to any of the 90 per cent. which we get from China, which we claim is due to the much colder climate in Russia.

There is a remarkable difference between bristle which is grown in summer and bristle which is grown in winter. It takes considerable experience to be able to detect the difference, but the difference is noticeable. Microscopic examination has proven to us that all bristle and horsehair is hollow, the same as human hair. It is claimed by scientists that the hollow part acts as an oil feeder, getting its nourishment from the root.

All bristle has a flag or split end, which lifts the paint or any liquid. Without it the paint would naturally have a tendency to run off. You will very often notice in a brush a certain amount of short bristles. This is done for two reasons.

First, that there will always be some flag ends in the brush, so when the long bristle wears down the flag on the short

bristle will come into play. If it were not for this the brush would not hold as much paint or material, and in addition to this the brush would wear stubby.

Second, it enables the manufacturer to produce a practical brush for less money than if he would be obliged to use all the same length of bristle.

There is one noticeable feature in the better grade of Russian bristles, which we do not find in any other, and that is on account of being of a very heavy body, the flag end splits open as the bristle wears down, which is not the case with other bristle.

Russian bristle ranges in lengths from 3½ to 7 in.; French bristle ranges in lengths from 55 mm. or 2 in. to 125 mm. or 4¾ in.; China bristle ranges in lengths from 2½ to 7 in.

In the brush industry, as in most other lines of manufacture, there are several inferior products which are used to cheapen the cost of production. The main one in our line is horse hair, which is the mane and tail of the horse. A great deal of this hair is secured from Texas. The distinguishing feature between horse hair and bristle is, firstly, that horse hair does not contain the elasticity and life that we find in bristle. Secondly, it does not have the flag or split end as bristle. Thirdly, it does not taper as bristle, and is practically the same length on either end of the hair; whereas, bristle tapers to a point. Bristle tapers from 18 to 33/1000 part of an inch, whereas horse hair does not taper over 4/1000 part of an inch.

To prove to you the importance of the flag end of bristle, we are obliged to buy it in each and every length that is required separately, whereas horse hair we buy in lengths up to 15 inches, and we cut it in lengths to suit our purposes.

It is very difficult for any one who is not exceptionally familiar with brushes to be able to detect a mixture of from five to eight per cent. horse hair in a brush. Special care must be taken on the part of the brush manufacturers not to permit too much horse hair to be put in the brush, for the reason that too much horse hair will make the brush work flabby.

There is one other material cheaper than horse hair which is sometimes used in the very cheapest brushes. This is known as tampica, or grass, which grows in South America and Mexico. This is a very coarse fibre, and has no wearing qualities whatever compared to bristle. This used in a paint brush would be very apt to turn out a job streaky, as it is entirely too coarse and rough for paint work.

It is well to make a special study in distinguishing horse hair and tampica from bristle, so in analyzing a brush you can detect the inferior part.

The preparation of foreign bristle to be used in making brushes is entirely carried on by the manufacturers of brushes, who have their own methods, which they hold as trade secrets. In preparing bristle it is necessary to wash and steam, and in some cases bleach. This process we know as the process of straightening, because it would be impracticable to use the hair as it is on account of it being in a natural curl, which must be taken out. Then it is mixed in separate batches and then taken to the brush maker. He in turn weighs the bristle for each brush separately, and sometimes it is weighed as close as 1/32 of an ounce. When we handle such as camel hair and badger it is necessary to use as close as 1/64 part of an ounce.

We want to call your special attention to the way a chisel brush is made. The proper arrangement of the flags to form the chisel end is effected in a box having an interior shape like that to be imparted to the exterior of the brush. It is open at the top and closed at the bottom by two plain surfaces

equally inclined to the axis and intersecting in a line perpendicular to it. It is large enough in diameter to permit the easy introduction of all the bristle for the brush, and in depth something less than their lengths. The bristles are first accurately weighed as for other forms of brushes, then combed and introduced, flags downward, into the box. The slopes of the bottom are coated with fine sand and glue so that the flags do not slip down toward the center, but remain in a vertical position. By gently jarring the box all the bristles sink until they come in contact with the sanded surfaces, so that finally the soft end of the bundle of bristle assumes the exact shape of the bottom of the box. The root is then firmly bound with twine before the removal of the box. The roots, made uneven by the process, are trimmed off and then it is put into the ferrule.

There are three different ways of making the bristle fast in the ferrule or band. One is the cement set, which is guaranteed to be used in any material except alcohol, as alcohol will soften the cement. In order to overcome that we have been using glue set brushes, which make an elegant shellac brush, but cannot be used in water, as you all know water dissolves glue; but in recent years there has been a popular demand for what is known as the vulcanized-in-rubber brush, which will overcome the shortcomings of either the cement or glue set brushes, and when constructing a vulcanized-in-rubber brush the rubber is used in a semi-paste form and afterward vulcanized. This is claimed by a great many practical painters to be the best way of fastening bristle in a brush, although there has been considerable criticism about this process, claiming the heat in vulcanizing has a tendency to bake the life out of bristle. We are ready to admit that the life can be baked out of bristle in the process of vulcanizing if it is not properly done, but with the up-to-date appliances there is little danger of this, except through the carelessness of the mechanic.

BRUNSWICK GREEN AND ITS PROPERTIES

Brunswick green is a composite pigment containing Prussian blue, pale chrome yellow, and barytes. Chrome green is a very similar pigment, except that it contains no barytes, so that it is quite possible to produce a Brunswick green from it, simply by reducing with barytes. Brunswick green is made and used in a range of shades from extra pale to extra deep; the shade obtained is entirely dependent upon the quantity of Prussian blue used, the proportions of the other materials being identical. Approximately the proportion of Prussian blues used would be as follows: Extra pale $\frac{1}{2}$ per cent., pale 1 per cent., middle 2 per cent., deep 4 per cent., extra deep 8 per cent.; this, however, varies with different makers, as manufacturers' standards vary. There are three methods of manufacture generally in use. First, by mixing in the dry state; second, by mixing in the pulp or wet state; and third, by direct precipitation. The last mentioned is that more generally employed, as the product is certainly better in color and general uniformity, and least possesses the tendency for the light specific gravity Prussian blue to separate out when used in paint form.

The starting point of the manufacture of Brunswick green by direct precipitation, is the calculation of the quantities of the necessary ingredients for the production of the chief constituent, lemon chrome yellow. From chemical formula we find that so much bichromate of potash in conjunction with a certain quantity of sulphate of soda react upon a given weight of lead acetate (sugar of lead) to produce a definite quantity of chrome yellow (chromate of lead). From practice it will have been found that this weight of lead chromate or chrome yellow, with the percentages of Prussian blue before mentioned, give certain definite shades.

The bichromate of potash crystal is dissolved in hot water, and to this is added the sulphate of soda crystal; this solution is allowed to cool in the vessel in which it is contained, while mixing together into a thin pasty mass the Prussian blue with

10 to 15 per cent. of its weight of oxalic acid crystal. This pasty mass is added gradually into a solution of 5 per cent. prussiate of potash, chemically known as potassium ferrocyanide, the strength of which is approximately 20 per cent. of the Prussian blue used. This mixture is well stirred, and raised to boiling for about half an hour. The mixture is then well incorporated. The Prussian blue is now in soluble form, that is to say, soluble in water; this mixture is now added to the solution containing the bichromate of potash and sulphate of soda, and stirred together. This is then precipitated on to a solution of lead acetate or sugar of lead containing of crystal approximately $1\frac{1}{2}$ times the combined weight of the mixture which is added, and to which had been added a solution of cream of tartar, equal approximately to 3 per cent. of the lead acetate used. The function of this chemical being to precipitate a chrome of a greenish tone, the reactions taking place during the blending of these two solutions are that lead oxalate is formed, and this has the effect of throwing out the Prussian blue in an insoluble form on to the chrome yellow produced with the bichromate. This simultaneous precipitation of chrome yellow and Prussian blue secures a perfectly incorporated mass of green pigment, and which, so far as it is practicable, is homogenous and fixed. The dilution of this precipitated green with the necessary barytes is quite an easy matter. The mineral is digested with water to a thin pasty mass, and is then passed through a strainer into the precipitant, the whole being well stirred during the process, after which additional water is added to properly cleanse the pigment of free acid. When this is effected the color is allowed to settle and the clear solution is decanted; the remainder is stirred up again and transferred to the filter press by means of a pump, from which it is conveyed to the drying room. The dried pigment is then powdered and in this state can be marketed or further manipulated in oil or turpentine for paint use. The pigment should be palpably fine as it comes from the powdering mill if extraneous matter has been removed before passing into the filter press, and a suitable mill used for the powdering, so that the costly procedure of sifting is eliminated.

Brunswick green possesses the property of good opacity; that is to say, it covers or obliterates undercoats effectively.

The permanency is good, but strong light tends to darken or cause the green to become "bluer." This may be due to the composition of the pigment. When the chrome fades, and consequently the blue stands out more prominently, or due to the floating of the blue through an imperfect incorporation of the pigments, sometimes seen when Brunswick green is made by dry blending. This separation is noticeable at times in the container, even before application.

This pigment is unaffected by weak acids; it becomes changed or decomposed almost immediately by alkalis.

STRIPING OR LINING

The most suitable brushes for this description of work are sable pencils, brown sable being the best, and red sable following. Camel's hair pencils are employed by some liners, but about the superiority of sable brushes the painting trade is unanimous. These pencils are known technically by the name of the species, of quill in which the hairs are set, as "crow," "duck," "goose," "full goose," "extra full goose," "small swan," "middle swan," and "large swan." The liner, of course, selects one suited to the kind of line he requires to produce. The paint, thinned down to the proper degree of consistency, is placed upon a palette or piece of stout glass, and the pencil is charged by working it well on and in the color. An old spoke is a good thing to practice on. The spoke is held in the operator's left hand, with the lower end resting on the bench or a trestle; the sable pencil, well, but not over, charged with color, and held firmly, but without constraint, between the thumb and forefinger of the right hand, is then applied to the extremity of the spoke farthest from the painter. The second, third, and

fourth fingers of the right hand should rest lightly on the work, and the pencil should then be applied exactly in the center of the spoke, and be then steadily and equally drawn toward the operator. When the painter finds the line becoming poorly fed or nished with more color. Before putting away his brushes, the painter should remove every particle of color from them by well washing them in turps, and they should also be greased to keep them in good form. For this purpose a lump of Russian tallow melted down in neatsfoot oil is suitable. The pencils should be kept lying on a piece of glass or smooth tin, with the hairs perfectly straight. Different shops vary considerably in their style of lining, some preferring light and others heavy lines. We may, perhaps, consider the most orthodox English style in good shops to be a broad central line with a fine one of the same or another color on each side of it. Of late years, however, the French style, which is lighter and more chic, has materially influenced matters.

With regard to the contrast between the ground and the striping, we may note that vermilion looks well on a body of purple lake or blue or yellow; brown shows well on yellow or white; blue is adapted to black and the crimson lakes; chocolate suits white; tan forms a delicate striping on white; and black adapts itself to almost any color.

FLATTING

Of all work in the painting department, flattening makes the least show; but it is nevertheless of primary importance if a good result be wanted. Methods of flattening vary a good deal, but the carriage builder usually employs sand, glass-paper, or pumice stone. A substance called "steel wool" has been suggested from time to time for flattening purposes, but up to the present time is has not received the attention which some think it deserves. The steel wool is made in three grades, coarse, medium, and fine, and consists of tiny threads of hard and elastic steel mixed together, so that they have the appearance of a gray wool. It is claimed that the "wool" will cut down a coat of varnish, polish, or japan, in about half the time occupied when pumice stone or sandpaper is used, and will give a much better finish.

Flattening should be done with perfect evenness, but without any very great pressure; and it should not be considered finished until the whole surface is uniformly dulled. For finishing the work, perhaps, levigated pumice powder is the most satisfactory agent.

When the first coat of varnish has been properly flattened, or rubbed down, there will be no need to flat any of the subsequent coats as is done in some establishments. The second coat may perhaps be dulled with the felt, but between the last two coats there should not be any rubbing at all.

With regard to flattening varnish, a good sound quality must be obtained, but extravagant prices need not be paid, and it should not dry slowly, or harden on the surface only. Indeed, no good varnish should harden on the surface and prevent the inner layer from drying. The best proof of a really first class varnish is that it hardens throughout equally.

FLAKING

Those who use metal for paneling bodies are sometimes confronted with the trouble of the paint flaking. This is a defect which is set up from similar causes which operate to produce blistering. Flaking may be set up by any of the following:

1. Too much oil in any of the coats.
2. Adulterated turpentine.
3. Poor quality material.
4. Moisture.
5. Hurried work.
6. Color too quick drying.
7. Rubbing overdone.
8. Inequalities in surface.

It has also been pointed out that an acid reaction may be set up in the neighborhood of any soldering work, which, no doubt, in many instances would contribute to the setting up of flaking.

MOTOR CAR ENAMELLING

There are thousands of motor vehicles, private and commercial, which require periodical attention on the part of the painter, and there is no reason why this lucrative business should be confined to the coach painting shops.

Good prices are now to be obtained, and much larger profits are to be made. No particular plant is required, the most necessary item being a clean, well-lighted shop in which to do the actual painting. The cleaning and preparatory work can be done in a shed or covered yard.

Motor car finish ranks on the average a little lower than the best coach finish, and the renewals are far more frequent by reason of the greater wear and tear which the surface has to withstand. In fact, the old laborious style of coach painting does not produce an ideal finish for motor cars, and a less costly, but tougher finish has been evolved. Again, the number of light color paints used for motor car work has brought about many changes in the painting procedure, and we now find that enamel paints are popular.

This brings the work within the possibility of the trained brush hand, especially when we deal only with re-painting jobs. He might possibly be below the required standard when dealing with filling up and surfacing, such as would be necessary on new work, but on re-paints it is usually only necessary to rub down the old surface and apply the new paint. A good brush hand has probably had more experience in spreading enamel paint than the average coach painter, and if he will only follow some of the latter's expedients in producing a clean finish, he would more than hold his own.

The use of enamel paints for this purpose is simplicity itself, the chief care being the choice of material. This is of the utmost importance, as the least tendency to brittleness on the part of the enamel or the undercoats, is liable to prove disastrous, on account of the excessive vibration to which the surface is subject. The enamel paint must be tough but elastic, a combination which is somewhat contradictory, and to be found in extremely few of the materials now on the market.

As to process, the following is probably the most simple:

Altogether three coats are given after the rubbing down and touching up of the old surface is completed. Having settled upon the color desired, a pattern is sent to the manufacturers of the enamel paint which it is decided to use, with an order for a sufficient quantity of undercoat and gloss finish to the selected color. For a large car this would mean a quarter gallon of each.

You first apply a coat of the undercoating all over, keeping it as fine as possible.

When this is dry, it is followed by a second coat of undercoating, to which has been added a liberal quantity of the finishing gloss.

This will dry to a semi-gloss, and when flattened down with pumice powder will present an ideal surface for the final coat of full gloss.

Space will not permit us to enter into all the details connected with the application of the finishing coat, upon which so much depends.—C. E. Oliver, in *The Decorator*.

MIXING COLORS

No small share of the brilliancy and depth of tone of a color is wrought out in the mixing cup under the manipulation of the ladle. A fine, sensitive pigment that is literally soused in turpentine at the inception of the mixing operation, and then beaten imperfectly in the thinner, cannot be made to do what it might do under different treatment. No color should be drowned at the beginning in turpentine, with the expectation that it may be teased into its normal self by some mysterious charm centered in the mixing paddle. The mixing of a batch of color should proceed in this wise: Into the mixing cup place the desired quantity of pigment. Next pour on a little turpen-

tine and beat the pigment into this, again adding, in due time, a little more thinner, in the meantime stirring the mass steadily.

Thus continue until the color is thoroughly liquefied, and stirred clear through into a smooth flowing condition. Thorough mixing of colors and pigments has more to do with both the tone and permanence of such colors and pigments than you may at first thought grant.

PRODUCTION OF KAURI GUM

The total production of kauri gum for the calendar year 1913 was 9,598 long tons, or 2,219 tons over the quantity produced for 1912. This increase was caused by a good demand for low grades, inducing a much larger output of the poorer quality. The quantity produced of good quality gum was not any larger, and probably less, than for preceding years. The total exports of kauri gum for 1913 were 8,549 tons, distributed as follows: To United States, 3,928 tons; Great Britain, 3,217 tons; Germany and Continent, 1,297 tons, and all other countries, 107 tons.

TO SOFTEN PUTTY

There are many ways to soften putty, but one of the best ways to soften it is by using kerosene oil.

To soften, take a putty knife, cut the putty into small pieces and then draw the blade of the knife over the putty until pulverized. The putty is now ready for the oil. Drop a little kerosene oil on it and mix up the putty and kerosene. If the putty is still too hard, add more oil until it can be easily worked.

TURPENTINE SUBSTITUTES

So important a position have the various paint thinners other than turpentine become that the American Society for Testing Materials has authorized a committee to make a study of and write specifications dealing with the subject. Members of the society have been asked to co-operate in this matter and a careful investigation of the physical and chemical properties of the several petroleum and coal tar distillates will be made.

CARMINE SUGGESTIONS

Carmin lining with fine lines of gold bronze on a myrtle green, which is a light shade of Brewster green, is indicated for a medium heavy buggy.

For a job of carmine lines, use light English vermilion mixed with rubbing varnish, adding a little coach japan to hasten the drying; glaze with carmine. The deep shade of English vermilion does not work as well as the light shade.

NOT NECESSARILY

The mere fact of troubles in the use of varnish does not imply that the varnish is of poor quality always. There are many conditions that adversely influence things, even where the varnish is of the highest grade.

EIGHT GOOD ADMONITIONS

A rubber tire concern has thought up and out the following, which it has named as above. It is for a motor man's gospel.

1. Take the corners on high—show people two wheels are all you need when you turn a curve. This stirs up a little excitement in the old town and gives the lazy but unwary pedestrian some beneficial practice in broad jumping.

2. Come to stop on a slide—select some spot on the curb and see how close you come to hitting it with your wheels locked. Buffalo Bill stopped his horses that way and made quite a hit with his Wild West show. You can put it all over any cowboy if you practice a little—never mind the tire expense.

3. If you start on high you can make your rear wheels spin beautifully. This is a little tough on the tires, but it marks the place where you hit the road.

4. Be a pillar of smoke by day and a streak of fire by night. This feat does not require much practice. Usually all you need to do is neglect to observe your exhaust.

5. Jump in your car quickly, put on the high speed—grab your wheel—throw in the juice with your free hand and let 'er rip. That shows you're a devil of a fellow and that you're in a hurry to get where you're going.

6. When your car is one of a long string that is held up by some obstruction, pull out of the line and get up ahead. Butt in ahead of the first car and stand crosswise of the road. When the obstruction is removed you will be able to show your dust to those others who failed to jockey you out of position.

7. When you come in your driveway late at night stop as near as you can to the window of your sleeping neighbor, then open your cut-out and let your engine hit 'er up for about a half hour. You can tell when she's missing then and you might also be able to tell what your neighbor thinks of you while he sits up in his bed and pours a line of earnest language in your direction.

8. A joke which is highly appreciated by most pedestrians is to have a driver skid a puddle of mud and throw dirty water all over their Sunday raiment. You can do this easily if you try and it makes a big hit, even with the man in overalls.

MONKEY WRENCH VISE

A good way to utilize the jaws of an ordinary monkey wrench is shown in illustration. Adjust the jaws of the wrench until

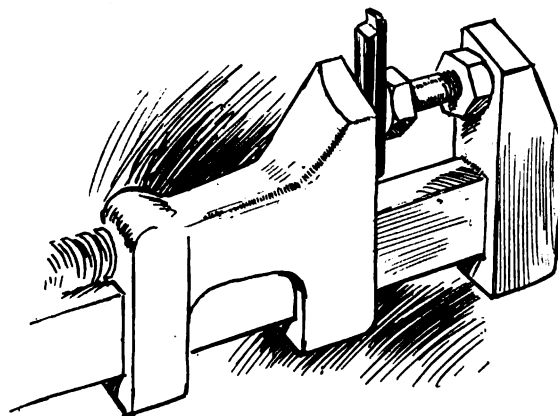

the piece to be held and a short machine bolt can be slipped into the space as shown. Then unscrew the nut until the piece is held firm and with the aid of wrenches the piece can be held.

HIS TEST FORMULA

A manufacturer uses the formula below as a business shock absorber. He recommends it. He submits every proposition to the following analytic test and claims that any proposition that passes all six questions favorably is well worth while. He asks himself:

1. Will it accomplish desirable results?
2. What will it cost?
3. What will it save?
4. What would I have to throw away, if anything, to use this idea?
5. When can I do it?
6. What else can I do that may be better?

Allegheny county, Pa., has more than 500 miles of paved highways, exclusive of city and borough streets. This big mileage of roads in the urban districts includes brick, asphalt, concrete bitulithic and tarvia.

GAS WELDING

The principle of oxyacetylene welding, or autogenous welding, as its name implies, is a fusion of the metals by heat, thus making them as solid as when one piece. This is accomplished by what is known as a feeder—a wire or rod of the same kind of metal as the article that is being welded. For instance; if you are welding cast iron you use a cast iron rod; for steel, steel wire, etc. In other words you must use a feeder having the same fusing or melting point as the article being welded.

The efficiency of an oxyacetylene weld depends on the skill of the operator entirely, and the care he uses in doing the work. In using the torch the preferable way is for the operator to work towards himself rather than away from himself. When the operator is working away from himself the flame of the torch is at an angle of about 60 degrees, and the flame is directed towards the unwelded portion of the work. In this position the force of the flame will crowd some of the melted metal out on the colder part of the work, which becomes chilled too suddenly to unite firmly with the metal in the article being welded, and this makes it very difficult to make a solid, firm weld or to build up the metal to a proper thickness. But if the work be directed toward the operator with the torch held at an angle of about 60 degrees, while the head of the torch is tilted at an angle of 60 to 120 degrees, with the finished part of the weld, the flame strikes the sloping part of the weld almost perpendicularly and has less of a tendency to displace the molten metal. In all cases where it is possible the torch itself should be held at an angle of about 60 degrees and the head or nozzle should be at a side angle of about 120.

To prepare any ordinary work for welding, the first thing to do is to cut a V-shaped groove along the line of the crack or break where the weld is to be made; cutting nearly to the bottom of or nearly through the article to be welded. The operator should have several diamond point chisels for this purpose. Care should be taken so as not to cut clear through. A hole through allows the melted metal to run through, and at the same time the flame from the torch will melt it more, causing it to become larger.

A welding flux for metals must be used for all metals with the exception of some grades of steel.

The article to be welded should be laid on the welding table or put in other convenient position, and if a heavy article it should be preheated. The preheating is done with a gas or gasoline torch such as is used for brazing. The idea in preheating is to save gases and also on heavy work it makes a more satisfactory weld. In adjusting the flame of the torch for cast iron it must have a brilliant, clean edge, a white, conical shaped flame in the center and right at the tip. This cone should be surrounded by a clear bluish flame. If the flame appears ragged or uneven it shows an excess of acetylene gas and is not satisfactory for cast iron. All other metals require an entirely different flame, having a slight excess of acetylene, making the white flame in the center of a ragged or rough appearance.

If the flame smokes or deposits any soot it is because there is too much acetylene being used to properly mix with the oxygen. In this case the acetylene must be turned off a little or a little more oxygen turned on.

Instead of welding in the bottom of the V-groove for a short distance and then forming a pool of molten metal of the required depth above it, the better way is to add constantly very small portions of the filling wire or rods, or feeders, to the advancing surface of molten metal in the groove. If the operator works toward himself this method is very easy. In this way the sides and bottom of the V-groove become melted by the time the weld reaches them, and the filling rod or feeder can be added to the small area of melted metal in a more uniform way.

To help keep the melted metal in place, the article should be, if possible, inclined upward in the direction in which the

weld is advancing; an inch to the foot being sufficient in most cases.

Instead of keeping the flame in contact with the melted metal all the time it is best to increase the distance as the metal melts. Of course, if it is removed too far the metal will not melt fast enough, and in case the metal melts too slow the work is not satisfactory.

The American Blacksmith has been developing gas welding very cleverly for all in interest.

SPOILING THE BEST SEAT IN THE CAR

For the mere passenger the best seat is beside the driver. To many other people it is oftentimes the best seat in the car, for anyone with a love of scenery and observation. The left front seat is an enviable position; it will seem strange that it has been rendered very uncomfortable since the introduction of high side doors and the scuttle dash. During a spell of hot weather, a passenger on an up-to-date car suffered so much from hot feet that he tilted his legs over the side of the car. Another victim relates that the intense heat in another ill-ventilated car spoiled the enjoyment of the run. Similar complaints are numerous.

The seat beside the driver is seldom properly ventilated. In the driving seat the discomfort is considerably less, for one is away from the neighborhood of the exhaust pipe; but on the other side of the car one's feet are often in close proximity to this heat conduit, and the temperature of the air under the scuttle dash becomes most unpleasant. Ventilators have been fixed in some cars, but in very few cases do they keep the air cool about the front passenger's feet on a really hot day.

CYCLECARS GREAT CLIMBERS

In a competition of this kind, Paris to Rouen, with contestants of both heavy and light cars, the little chaps carried off the honors.

It was possible to win a maximum of 60 points for regularity, separate awards being made in the hill climb. The machine to head the list was a twin-cylinder Violet-Bogey, with 59.180 points. The next seven were big cars. Then came a light car—the Audax—placed ninth. A Roger Renault light car (a make of machine just put on the market) was 11th, followed by a Morgan cyclecar securing 56.940 points.

Altogether, 33 cars succeeded in finishing the run. All the light cars finished and showed themselves equal to, and in many cases better than, the big expensive cars.

The hill climb was a revelation of the liveliness of the light cars. About 700 yards of a hill, with a maximum gradient of 18 per cent., had to be covered from a standing start. The 3-litre Peugeot racing car was the fastest with 43 2/5 seconds. In the light car section the fastest was a Bugatti, with 45 2/5 seconds, and the second machine was the Violet-Bogey which was first for regularity; it climbed the steep hill in 45 4/5 seconds. Morgan cyclecars finished third and fourth.

It is interesting to note that the first five in the light car class were faster than all but the first three in the big car and racing car sections. It would be difficult to find any more convincing proof that the light car is able to hold its own with costly cars.

STEEL CORPORATION WILL MAKE BENZOLE

The United States Steel Corporation, Sharon plant, has made an appropriation of \$400,000 for the erection of a plant in Farrell, in which it will manufacture benzole from the bi-product of its coke ovens. Its completion will be approximately a year hence.

The benzole is intended for use in motor cars, trucks and hydrocarbon engines used for stationary purposes. The steel corporation has been producing benzole in limited quantities

for some time and has tested its product. While no official figures are available from these tests, it is known that the benzole can be used with the same carbureter that uses gasoline, and that the fuel is entirely successful.

This entry of the steel corporation into the manufacture of motor fuel cannot be looked upon as having any serious bearing on the motor fuel world, because if all of the possible benzole available were extracted from the bi-product ovens the amount would only be sufficient to supply approximately the demand. The steel corporation could only manufacture benzole in cities where it has coke ovens, these being Sharon, Garry, Joliet, and Birmingham.

The use of benzole in official tests gives a higher fuel value than either gasoline or alcohol. It yields 135,000 b.t.u. per United States gallon and has a specific gravity of .889 at 0 degrees centigrade.

BODY PANELLING, GOLPO PROCESS

The new idea of the clever Frenchman Golpo, has been now well illustrated and described. This is what the leading French journal says about it:

The process consists in the employment of a kind of armored cement. This substance has been called Fibromonolithe by the inventor, who claims for it all the advantages of the use of wood and metal without any of their drawbacks. No limit is placed as regards the type of body which can be constructed, since illustrations are given of complete bodies, such as a torpedo with scuttle dash and a fully-enclosed car with rounded roof and top back panel, both bodies having shaped wheel-houses. The panelling consists in first attaching a metal-woven fabric to the usual wooden framing, on which is spread the special paste, which can be easily molded, and when once dry can be planed and finished off with the same ease as a mahogany panel. Before attaching the metal fabric strips of cane are nailed on the framing. It is stated that the paste is partly composed of pulverized wood, and is of a nature which naturally absorbs paint, which gives it a distinct point in its favor over the steel panel. The dry paste will also receive pins just like a piece of wood, while it has the advantage of being strengthened by the wire mesh base. This panelling substance is claimed to be unaffected by heat or cold, or by damp, while it is also fireproof. Another point claimed is that if a panel is pierced in a street collision it can be easily repaired, as the application of fresh paste over the hole only takes 24 hours to dry.

BELTS AGAINST ROPES

Manila rope is just as strong as a solid steel bar, weight for weight, though only about 11½ per cent. as strong per equal cross section. Leather is only about 5 per cent. as strong as a steel bar of equal cross section and less than 40 per cent. as strong per equal weight of material.

The relative efficiency of manila rope and leather belting for the transmission of power is not directly proportional to their respective strengths. Manila fibres, from which the rope is manufactured, are usually from eight to ten feet in length, are composed of elongated cells that possess great strength longitudinally, but are comparatively weak transversely. Leather, on the other hand, is about equally strong in any direction, so that the wear on such a belt is mostly external. In a manila rope the wear is largely internal, the elongated fibre cells being crushed together when passing around a sheave and breaking up into short pieces.

A worn out manila rope, as far as its strength is concerned, may have the outward appearance of an excellent rope while internally its construction is but a mass of short, broken particles. The allowable working stress of a good leather belt is customarily taken as 320 pounds per square inch, or about one-tenth its tensile strength. In the course of a year or so

a manila rope will lose about 50 per cent. of its original strength, after which the weakening becomes more gradual. Under such conditions it is safe to figure on an allowable working stress of about 288 pounds per square inch, or 1/32 its tensile strength.

AUTOMOBILES ARE A CENTURY OLD

The first application of steam power for propelling carriages was made by Oliver Evans, who died in New York 95 years ago. Evans was born in Delaware in 1775, and in his youth was a wheelwright's apprentice. About 1800 he attempted to build a horseless carriage, but the result, which was an ordinary carriage with a steam engine to supply the motive power, caused so much mirth and derision that Evans abandoned the scheme. He made several improvements in milling machinery and in 1814 invented the first steam dredging machine in America. Other inventors continued to dream of horseless carriages. About half a century ago New York was convulsed with merriment over what was called the "steam man," a figure constructed to drag a phaeton. About the same time in England the Earl of Caithness invented a steam carriage in which he made a journey of 140 miles in two days. R. W. Thomson, of Edinburgh, applied india rubber to the tires of the wheels of a road steamer in 1868. The first vehicle to bear any resemblance to the automobile of today was built by Siegfried Marcus, of Vienna, in 1873. It was driven by an internal combustion motor, but it served no practical purpose other than pointing the way to later and more successful inventors.

REMOVING TOOL FOR SPLIT PISTON RINGS

It is quite a simple matter to make a piston ring removing tool for rings which are split vertically. Experience is that almost 75 per cent. of piston rings are so split, and, in order to cope with their removal when overhauling an engine, a tool is constructed of which a sketch of device is illustrated. It is made from two pieces of mild steel ½ x 5/16 in. section and 7 in. long. The joint holes are drilled about 2 in. from one end of each bar, and the handle portion is rounded, either by means of a file or in a lathe. The opposite ends are filed down, the groove in each having one vertical side, while the other slopes upward at an angle of 45 degrees. The lowest portion of the slots reaches within 1/16 in. from the bottom of each end, both pieces being made the same, as, when reversed in assembling, they fit the ring in the required manner. The metal at each end is cut back from the slotted portion, allowing a projection of about ¼ in. The tool can be finished off with a spring and adjusting screw.

ORGANIZE NUTTER GEARWOOD CO.

A new industry for Seymour, Ind., has been organized by Alonzo Nutter, with a capital stock of \$25,000. The company will manufacture carriages, buggies, and spring wagon gear woods and will be known as the Nutter Gearwood Co.

About twelve years ago Mr. Nutter organized the Zanesville (O.) Gearwood Co. and was its prime mover until January 1, 1914.

Mr. Nutter is one of the most practical and competent gearwood men in the trade. He is well qualified to control the new industry and great success is predicted for him in the Indiana field.

AN IDEA

Why wouldn't the new French fibromonolithe process mentioned in this number be a good thing for light vehicle bodies? It would be easy to create new body designs, exclusive, and good or bad, according to the taste or lack of it of the draftsman, and at least get away from the stereotyped sameness that now afflicts the light vehicle trade.

TESTING CYLINDER OILS

It is obvious that comparative tests of a number of oils could be carried out with no special apparatus by exposing in similar vessels equal amounts of the various oils to a comparatively high temperature, say, in an ordinary oven, for a considerable period and then examining the residue for quantity and properties.

Some years ago tests on a wide range of petroleum engine oils that were made by the simple heating of 1 gramme of oil to 400 degrees Fahr. for six hours. Appreciable differences were shown and gave a test of practical value.

Generally speaking, gas engine oils and the cheaper oils gave the worst results, though the thick steam cylinder oils gave results practically equal to the most expensive air-cooled oils. The viscosity of the black cylinder oils was against their use for gasoline engines, but one obtained at 22 cents per gallon and mixed with 10 per cent. of ordinary paraffin to reduce it to a reasonable viscosity, had an exceedingly low loss on the heat test, and after the addition of 10 per cent. of paraffin it was found that the total loss was only six per cent., showing that something like half the paraffin was retained by the lubricating oil even after six hours heating at 400 degrees Fahr. Five gallons of the mixture was used on two different cars, and no difference of any kind was experienced in use.

Obviously the oil which loses the least and leaves a residue most like the original oil is the most desirable sample.

There is very little connection between the flashpoint of an oil and the result of the loss test.

Experiments on the rate of loss in weight of an oil at two or three temperatures enables one to tell whether the oil as a whole is fairly homogeneous or whether it contains several constituents of very different character.

This brings us to the consideration of the influence of temperature on the viscosity, that is the thickness of lubricating oil. Most of the valuable data are those dealing with viscosity of oils between ordinary temperatures and 200 degrees Fahr., but in crank case lubrication we have to do with temperatures on the cylinder walls which much exceed these.

The differences in the viscosity are comparatively slight at higher temperatures. This is a characteristic, particularly of mineral oils. The rate of falling off in viscosity of animal oils such as sperm and lard oils, and vegetable oil such as castor oil, is not quite so rapid, and this property, conjointly with the extra oiliness of animal and vegetable oils, has led to their utilization in racing car engines. Owing to the comparatively high temperatures of crank case oil there is no danger that an oil will be too thick when once it has got into use in the crank case. We must, however, use an oil which at ordinary temperature is sufficiently fluid to pass through the constrictions of the lubricating system, and this alone marks the maximum limit of allowable viscosity.

WHEEL TESTS

The Engineering department of the University of Michigan has been testing wheels.

The tabulated results show that the wire wheel failed at about 4,000 pounds per square inch; the wood type at 5,000; and the steel at 8,940. The wheels were tested in a Riehle horizontal testing machine, with the support at the hub and the load applied at the rim, just as it would be in case the wheel struck a curb or any other lateral blow. The load was applied in the same way in each case, and in increments of 500 pounds per square inch. After every 1,000 pound application, the load was brought down again to 500 pounds per square inch and the permanent set or deflection measured.

In presenting this data the engineers first explained the construction of the steel wheel, pointing out that the spoke section is made in halves which are electrically welded together along the length of the spokes. The outer end of the spokes are then

spot-welded to the rim. The hub portion is a part of the spoke section, and here is incorporated the demountable feature, since five bolts go through this portion and fasten the wheel to the hub.

The reports of the University of Michigan, together with data and curves, were then submitted. In commenting on the data it was pointed out that the permanent deflection of the wire wheel was not measured, because, due to the spring action of the wire wheel, the deflectometer would not register it. Contrary to some tests made in England, in which the nipple heads tore through the rim, the wire wheel tested at the University showed remarkable rim strength, the spokes themselves parting, but there being no nipple heads pulling through the rim section.

In making the tests with the load applied to the rim of the wheel in the Riele horizontal testing machines it started at 60 pounds, and of which load neither the steel, the wood nor the wire wheel showed any deflection. With the weight increased to 100 pounds there was a deflection of .001 inch in the steel and wire wheels, and twice this amount in the wood wheel. With a load of 500 pounds the deflections were, steel .016 inch, the wire .024 inch, and wood .013. At 1,000 pounds the deflections were, wire .030, wood .033 and steel .041. At 2,000 pounds the deflections were, steel .068, wood .121, and wire .215.

THE DICTUM OF A SELF-SUFFICIENT DADO

We copy from the New York Times a few observations that very politely—too politely—characterize the very silly miasma that rises and disperses from what Mr. Joy thinks is his mind. The Times says:

Henry B. Joy, the Detroit automobile manufacturer, repeats with elaboration his previous assertion of his right and intention to place his advertising where he pleases, and adds that where he pleases is in newspapers and other publications which are "constructive," not "destructive."

This right is indubitable, and his intention is justifiable. As a manifestation of personal preference and judgment the propriety of his policy has never been denied. But the announcement itself, and especially its repetition, will perhaps excuse the appearance in some minds of the thought that Mr. Joy, not content with doing as he pleases, is endeavoring to lead other advertisers into making the same discrimination among "mediums" that he does himself.

Moreover, Mr. Joy apparently has not given as much attention as he should to the fact that a newspaper also has a right to decide for itself what its policies are to be, and a duty not to be influenced by the loss of revenue which, implicitly if not explicitly, he threatens to inflict should the choice offend him. The paper which does allow itself so to be influenced is doomed to a short and disgraceful career, and those who advertise in it before its demise will get but a poor return for their money.

Another thing seemingly forgotten by Mr. Joy is that there are times for destruction as well as for construction—that often the former must precede the latter to make it possible—that destructiveness is not to be condemned as such, but only when it is ill-advised, unnecessary, or harmful. Mr. Joy himself aims at the destruction of the newspapers of which he does not approve, and he will succeed in effecting it if a sufficient number of advertisers prove to be as "suggestible" as he, perhaps unconsciously, hopes.

BANKERS WANT BREWSTER

The election of William Brewster, head of Brewster & Co., as a Class B Director of the Federal Reserve Bank of New York is urged in a circular letter that has been sent out by banks.

Mr. Brewster and F. F. Peabody, the collar manufacturer of Troy, were put up by the nominating committee appointed by the conference of medium-sized banks. The insurgent candidate for the place is William B. Thompson, of Yonkers and

New York, who has large manufacturing and mining interests and is the head of the Stock Exchange firm of Thompson, Towle & Co. Only one can be elected, as only one Class B director is to be chosen by the group of banks concerned.

Mr. Brewster is 48 years of age, highly educated, and is president of Brewster & Co., a concern founded by his grandfather in 1810. He employs 1,000 men. He is a director of the Northern Insurance Co., a director of the Chamber of Commerce of Queens county, a member of the Metropolitan Museum of Art, a life member of the Museum of Natural History. He is a member of the Union League, Automobile Club of America, Piping Rock, and Sleepy Hollow clubs.

With the election of Mr. Brewster, our group is assured of a representative who will at all times be able and glad to afford the counsel and help as to the working and benefits to be derived from the Federal Reserve act.

WHAT WE USE FROM OTHER LANDS

Of great practical value to the American business man seeking information regarding foreign markets for the goods which he handles or the sources of imported raw materials and of good competing with domestic products are two publications presenting details with respect to every important article exported from, or imported into, the United States, prepared by the Bureau of Foreign and Domestic Commerce, Department of Commerce.

It is interesting to note, for example, that coffee is now supplied almost exclusively by Brazil, Central America, and other tropical countries of the western hemisphere; that sugar, formerly imported in large quantities from Java and the sugar-beet countries of Europe, is now chiefly supplied by Cuba, the Philippines, and the domestic product including Hawaii and Porto Rico; and that champagne shows constantly diminishing importations as a result of the rapidly expanding home output. American factories consume great quantities of imported materials, last year's imports including 50 million dollars' worth of fibers, 80 million dollars' worth of raw silk, and 100 million dollars' worth each of india rubber and hides. These are mere examples of the more than 500 different classes of articles whose sources are shown in Table 3 of Commerce and Navigation of the United States.

ITALIAN REGULATION AS TO WIDTH OF RIMS

Vice Consul Piero Gianolio, Turin, writes that new regulations governing the width of wheel rims are being drawn up, and will be enforced throughout all Italy within two years from the date of promulgation. They refer to all vehicles the wheels of which are furnished with rims not covered with rubber or other elastic substance.

The weight, including the load, of a vehicle with one axle, drawn by animals, must not exceed 50 metric quintals (1 metric quintal=220.46 pounds) or 80 metric quintals if with two axles. The minimum width of each rim for animal-drawn vehicles is established as follows, in relation to the load: Two-wheel vehicles weighing with load—4 to 8 metric quintals, 40 millimeters (1.575 in.); 8 to 12 metric quintals, 50 millimeters (1.969 in.); 12 to 20 metric quintals, 60 millimeters (2.362 in.); 20 to 30 metric quintals, 80 millimeters (3.15 inches); 30 to 40 metric quintals, 100 millimeters (3.937 in.); 40 to 50 metric quintals, 120 millimeters (4.624 in.). Four-wheel vehicles weighing with load—10 to 15 metric quintals, 40 millimeters; 15 to 30 metric quintals, 60 millimeters; 30 to 50 metric quintals, 80 millimeters; 50 to 80 metric quintals, 100 millimeters.

Power-driven vehicles are entitled to 1½ metric quintals gross weight for each centimeter (1 centimeter=0.3937 in.) of rim on both the front and back wheels. In no case will a narrower rim than 10 centimeters be allowed. All rims, either for animal-drawn or for power-propelled vehicles, must have a flat surface. The width will be calculated exclusive of the rounding off of

the edges when exceeding 1 centimeter on each side. Besides the number, the net weight must be marked on each vehicle.

FRENCHMAN WHO MADE ALUMINUM POSSIBLE

Word has been received of the death at Cannes of Paul Louis Toussaint Heroult, chemist and inventor, who made aluminum commercially possible and who invented the electric furnace now in use in the steel industry.

M. Heroult was born on April 10, 1863, the son of a Paris tanner. He was educated in London and Paris. His method of producing aluminum was perfected in 1886. The following year he went to Neubrausen, Switzerland, as technical manager of the aluminum works there, and two years later came to America.

In 1889 he invented the electric furnace, and retaining control of the patent, became connected with the United States Steel Corporation and other steel companies of the United States, Canada, Sweden and England. He made a survey of the mineral deposits of Canada, the report of which is the authority on the subject.

A SPRING SPREADER

The illustration shows the method of using a spring spreading device that a reader of *The Automobile* says is a very handy

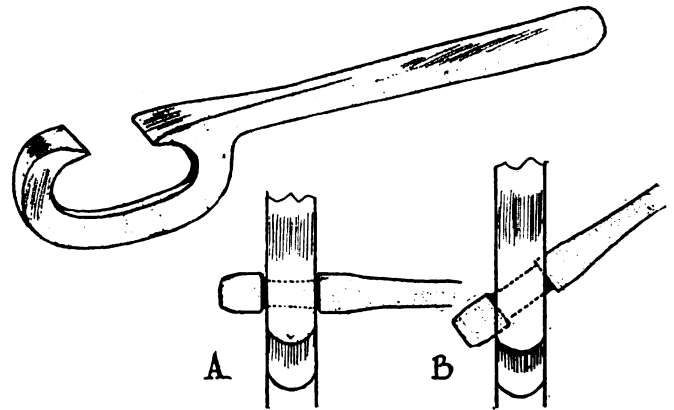

tool. It is easily forged out of soft steel and the tips may be slightly case-hardened if desired. The handle may be made of any length to suit the strength of the operator.

MOTOR TRUCK LOADING DEVICE

From Germany comes an ingenious method of loading brick from kiln to motor truck without handling individual brick, thus saving breakage. A low wall separates the truck from the track upon which the car from the kiln is run. A mechanically operated rammer at the same level as the top of the wall, which is also the level of the car platform and the floor of the truck, pushes the load of brick from the car across the wall, directly upon the truck.

DISPOSES OF SPRING BUSINESS

Lewis Spring & Axle Co. has disposed of that portion of its business devoted to the manufacture of springs to a company styled Alloy Steel Spring Co., of which Fred Keiser, vice-president of the Lewis company, is head. The other officers are, Casper Haehnie, vice-president, and A. L. Wuster, secretary and treasurer. Under the terms of the sale, the Lewis interests acquire the E. C. Clark Motor Co., Jackson, Mich., of which Lewis is treasurer. Except that springs hereafter will be produced by the Alloy Steel Spring Co., the Lewis Spring & Axle Co. will continue its business as heretofore.

LOWER RUBBER PRICES

The U. S. Consul at Rotterdam speaking of rubber, reports on lower prices as follows:

The year 1913 was characterized by large imports and continued dropping of prices. The total quantity brought on the market here was twice as large as in 1912, viz., 2,286,900 pounds in 1913, against 1,034,440 pounds in 1912, while at the beginning of the year the price was twice as high as at the end. If the large production and the downward tendency of the prices continue, rubber will be cheap enough to be used for purposes heretofore unthought of. The whole quantity marketed was sold at a fair price, at times even higher than on other markets abroad. Several kinds of rubber were sent to the Netherlands which in former years were sold elsewhere. The quality of the product marketed here is steadily improving, while the shipments are coming more regularly than before.

Forest rubber had no demand, but at the end of the year the prices improved, so that practically the whole stock was sold at a good price. Plantation rubber of good quality found a ready market and high prices were obtained. Prices of castilloa fluctuated considerably. The prices of plantation rubber fluctuated from \$1.32 to \$0.44 per pound.

Considerable quantities of balata were imported. Prices at first dropped to \$0.59 per pound, but afterwards went up to about \$0.75.

CLUB OF REPUBLIC RUBBER CO. OFFERS MANY FACILITIES

That a clubhouse intended for the working people in a factory can be operated successfully has been demonstrated during the last six weeks by the Republic Rubber Co., Youngstown, O., whose clubhouse for its employees was opened on January 15. The clubhouse is located across the street from the factory, and is a \$60,000 fireproof, concrete and brick three-story structure, built by the directors of the Republic company. It is not a clubhouse for the heads of departments or for superintendents, but for the men and women who work, and while the clubhouse and grounds are the property of the company they are placed at the disposal and for the use of everyone connected therewith.

At first it was said that the working men and working women would not use such a club, and that it would be a failure. The fact is the club in its six weeks' history has 676 sustaining members who have paid \$1 per year membership for all club privileges; in addition to this, every one of the company's employes has the privilege of lunching in the club.

Before the end of the first month, 300 of the working men and women were taking lunches and other meals at the clubhouse each day, and 300 others bringing their own lunches were using one of the dining rooms for eating their own lunches, and buying a hot cup of coffee or a bottle of milk in addition at a price which would put the rates of the average lunch counter to shame.

Other parts of the club have, in its short history, been patronized as well if not better than the dining rooms. The basement is entirely given over to recreation with its six bowling alleys, its pool tables, its reading rooms, its recreation rooms, its gymnasium equipment, and its shower baths, all of which are privileges enjoyed for the fee of \$1 per annum. The club is open until 11 o'clock each evening.

SALTING TIMBER

It was found in replacing a recently burned railroad trestle along the north shore of Great Salt Lake, Utah, that the piles were sound after 43 years of service. These were of local pine and fir, but were found to have been impregnated with salt from the lake.

The result of this investigation is what started the United States Forest Service on its recent examinations of the use of

salts as a preservative of timber. At another point on the lake, some 18 inch piles, 29 years old, have been similarly preserved with salt which has penetrated to the center. Timbers in the Southern Pacific Railroad trestles across the lake, placed in 1902, appear as good as when driven, and have been preserved above the water line by salt spray dashed upon them. The first transcontinental telegraph line, which was built before the first railroad, extended west from Salt Lake City through the then prosperous mining camps of Eureka, Austin and Virginia City. When the railroad was built the telegraph line was transferred to this right of way and the old poles were sawed off at the ground. A recent examination of the butts left in the ground in the salt desert near Fish Springs, Utah, showed that after the 50 years, since the poles were cut off, the butts were perfectly sound. It has been common practice in the Salt Lake Valley to preserve poles by putting about 75 pounds of salt in the ground around the butts.

FRANCE TO TAX AUTOMOBILES FOR GOOD ROADS

France needs a few million francs for additional expenditure on roads and is endeavoring to squeeze the amount out of automobile owners. Before its overthrow a few weeks ago, the late government had a supplementary automobile taxation bill before the house and also proposed to increase the rate of taxation under the income tax law when the person owned an automobile.

Almost as soon as it got into power the new government introduced a bill under which a supplementary tax should be put on cars. This is at the rate of \$10 for cars of not more than 12 horsepower; \$15 for 13 to 24 horsepower; \$25 for 25 to 36 horsepower; \$40 for 37 to 60 horsepower, and \$50 for each car of more than 60 horsepower. These proposed taxes are in addition to what is at present paid.

It is believed that the revenue will be \$1,600,000, and this amount will be expended entirely on the improvement and maintenance of national roads.

DAMAGE SUIT

A damage suit has been filed against the Hickory Carriage Co., of Cincinnati, O. The plaintiff is Jennie Holden, administratrix of the estate of E. P. Holden, former employe of the company. The amount asked of court is \$10,000, and the cause of action alleged is that Holden contracted consumption while in the employ of the company, causing his death. A recent decision of a local court to the effect that "occupational diseases" are "personal injuries" incurred during the employment, within the meaning of the workmen's compensation law of Ohio, suggested the suit.

ELECTRIC AUTOMOBILE BRAKE

A recent innovation is an electric brake, which takes away from the driver the actual labor of applying the brakes. A very small motor, operating at high speed and supplied from a storage battery, furnishes the power for the braking mechanism. A drum at one end of the transverse shaft carries a steel cable to the brake levers, displacing the usual rod. To increase the pressure, it is merely necessary to open and close the circuit gain with the finger lever, and the drum makes a further revolution.

OVERLAND SIX TO SELL FOR \$1,475

Although it let it be known less than a year ago that there would be but a single model, the Willys-Overland Co. now has made announcement of its entry into the ranks of six-cylinders. To supplement the four-cylinder model, a seven-passenger six-cylinder has been added. The price will be \$1,475.

SUGGESTIONS FOR SECURING TRADE IN CENTRAL CUBA, FROM U. S. CONSUL

The distance to Cienfuegos is not as great as, or at least not greater than, that of much of the western part of the United States from the eastern manufacturing centers. Hence, American manufacturers should visit the trade personally or establish agencies, whose traveling representatives, men who know the trade, the language, and the custom of the merchants, would visit the inland towns at stated intervals or as often as may seem necessary. If they will do that and can compete in the line of good required, in quality and in prices with our most formidable European rivals, they will capture the trade, as the reciprocity agreement we have with Cuba gives them the advantage of a rebate of from 20 to 40 per cent. on duties over all other countries.

It is rather difficult to work up trade by catalogs, even though printed in Spanish, while circulars, catalogs, and correspondence in English are absolutely worthless for that purpose. When advertising it should be done only in trade papers that are published in Spanish.

ARTIFICIAL RUBBER A BY-PRODUCT OF STEEL MAKING

At a recent meeting of the Iron and Steel Institute in London, the president read a paper on by-products in steel manufacture. He discussed the utilization of blast furnace gases for operating gas engines and for illumination and heating, and the later developments in making nitric acid from these gases, and also the manufacture of bricks and cement from slags. All these matters have been under discussion for a number of years, but a new idea was presented at this meeting looking toward the synthetic production of india rubber from coke oven gases. The president's words were: "It was being sought to obtain from it the hydrocarbons, the derivatives of which were found in india rubber, and experiments that had been made permitted the foreshadowing of the manufacture of artificial rubber."

MOTOR BUNGALOW

A motor bungalow, mounted on the chassis of a two-ton truck, was the uncommon conveyance built recently to carry a party of several persons on a trip in California. Although it contained three roomy apartments, the traveling bungalow was only 26 feet long, 6½ feet wide, and 6 feet high, inside. The four walls were boarded up for about 3 feet from the floor and screened above, with canvas roll curtains to cover the screens. The roof was made of oiled canvas and had an extension that could be spread over an area, 10 x 22 feet, behind the car to shelter a dining table and several folding cots. The forward compartment, back of the driver's seat, contained four sleeping-car berths. Back of this was a small dressing room and a large observation platform with lockers for cooking utensils and provisions. Folding steps at the back furnished an entrance.

THIS IS TRUTH!

"The decriptive phrase 'stream-line,' as applied to body shapes, is borrowed from England," says W. H. Emond, Franklin body designer. "The Englishman is pretty clever in coining or applying characteristic descriptives to his productions. For example, he does not call a single-compartment, closed body by the meaningless name Sedan, he calls it a Pullman, because to his mind the single compartment suggests an American one-compartment Pullman railway coach, as distinguished from the English coach made up of a series of compartments.

"The term 'stream-line' was originally applied to bodies only, but the American adapter employs it whenever he makes an attempt to run body and hood lines together. If he really

did this and did it right, he would have a truly stream-line effect, but his efforts have been confined to putting a little slant and back flare in his engine hood, and strenuously bumping his body cowl so as to get a flush joint between the hood and cowl. The rest is advertising.

"To produce a true stream-line effect from radiator to tonneau, the designing on plan and section must be done at the radiator and at the section of greatest body width, corresponding to the midship section of a boat hull. The radiator section must be free from angles. Every section can then be proportionally developed from the minimum toward the maximum width. Much of the good effect is dependent upon the curves used in these two sections, and it is in this that most of the designer's skill is shown. The fact is, a true stream-line effect cannot be worked out of any haphazard shape of hood or radiator."

GOOD TRICK FOR THE DRAFTSMAN

For small drafts, blue prints, etc., that are not put away at once a good little device is the clothespin hanger here illustrated. This wire is placed through the spring coil openings; the

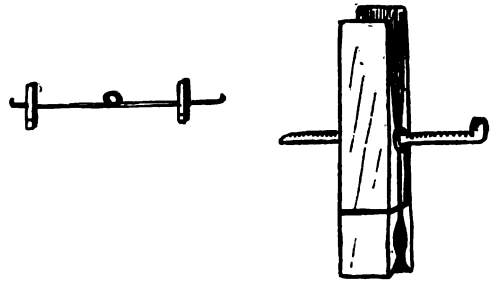

clothespin then being adjusted to desired positions by sliding them along the wire. The wire is bent at both ends to prevent the pins from coming off.

POPE HEADS MANUFACTURERS

At the meeting of the board of directors of the National Association of Manufacturers, Col. George Pope, of the Pope Mfg. Co., was reelected president. All of the other officers also were reelected, as follows: A. B. See, treasurer; J. Philip Bird, general manager and assistant treasurer; George S. Boudinot, secretary.

INVADES STATE

The Springfield Wagon Co., of Springfield, Mo., has filed a copy of its charter at the capital of Arkansas and entered the state for business. The concern will invest \$10,000 for its Arkansas business. Bert S. Lewis, of Fayetteville, is named as state agent.

"HERCULES" IS FAMILIAR NAME

The Hercules Motor Car Co. was formed in New Albany, Ind., by C. H., D. F. and A. B. Lambert, and other men, for the purpose of taking over the business and property of the Crown Motor Car Co. Its first, a four-passenger car, selling for \$495, is now ready. The new company is capitalized at \$1,500,000.

John D. Hallowel, formerly of the Moline Wagon Co., Moline, Ill., and the Winona Wagon Co., Winona, Minn., and also associated with the John Deere and Velie interests at Moline, has been appointed general manager of the Mitchell Wagon Co., a \$500,000 corporation organized recently by the purchasers of the wagon department of the Mitchell-Lewis Motor Co., Racine, Wis. The wagon works, which also builds motor car bodies, is now entirely distinct from the Mitchell-Lewis motor car works.

WHY BRITAIN DOESN'T PRODUCE MORE

The idea which seems to prevail in Britain at the present moment, among the companies which produce the better class of automobiles, is that if they went in for mass production they would lose their individuality entirely and that the automobile instead of having universal fame as a product which the highest engineering skill could produce would, by very reason of this mass production, become an inferior article. My reply to this, says D. McC. White, is that if an automobile cannot be designed without a tremendous quantity of individual and detailed skill then better far had it not been produced at all, because it must and will, by reason of its delicateness, become a nuisance to its owner and require constant skill and attention to keep it in perfect running order.

One thing that must be borne in mind is that the British engineer abhors any engineering production that appears cheap or shoddy and in many cases this is the British attitude throughout. On the other hand, the Britisher is, like the American, a man who takes a common sense view of things, and my opinion is that the British buyer demands from the British producer an article commensurate with the price he is asked to pay, and if the British producer did not demand such a high figure then he would not be asked for special types and alterations to his standard production. The man in Britain, if he buys a cheap and nasty automobile, knows it is cheap and nasty before he buys it, and makes allowances for its behavior.

In Britain manufacturers have never yet settled down to standard production. They produce in some of the largest factories no fewer than four or five different types of automobiles, and this necessitates switching over continuously, with disastrous results upon production, as well as upon prices.

If one considers the question of one of the largest producers in Britain manufacturing four different types of chassis, instead of producing the whole of one type and then switching over to the other types in sequence, the production manager is hampered by being required to produce 50 of each type, one after the other, and then perhaps he may be allowed to go on for 200 of one type before being again switched over. This is complicated, to say the least.

In addition to this, when he is half through with his year's production and has got things into full swing, the sales element will discover that they want more of another type, with the result that the unfortunate production manager must again switch over with an entire disorganization of the whole factory. Such cases as these repeat themselves right through, from department to department, and are never really got rid of.

Again, the replacement factor is aggravated because he must wait until his next batch of the same material comes through before the first batch is completed, because of the scrap which must and will occur.

OUR OWN BILLY IN NASHVILLE

This is a little late, but the president of the C. B. N. A. is very swift. It's hard to keep up. We find he has been visiting Nashville, but as president of "National Vehicle Manufacturers' Association." The distinguished visitor from the banks of the Mississippi was asked what he knew about business, and this is what he said:

"So far as they affect the buggy business, conditions are most encouraging. From all over the country come reports that lead me to believe that this will be one of the best buggy years since 1907. My friend Deeds has the dope about right when he says 'the pendulum is swinging back.' My company, for instance, has sold 28,000 buggies in the past three months. Wherever I go I find the dealers optimistic and feeling that they have no reason to be uneasy as to what the future will bring to them."

ASKED PRESIDENT TO PLEASE STOP—PROBABLY GETTING TOO CLOSE

Delegates from the Ohio Manufacturers' Association, as well as the Illinois Manufacturers' Association and the National Association of Manufacturers of Agricultural Implements and Vehicles, visited Senator Pomerene and had Pomerene take them before President Wilson who they requested to "give business a rest."

The delegations advised that the trade commission bill, which has passed the House, be enacted into law, but that no other trust legislation be taken up at this session.

"The country needs to think over these bills longer," said the manufacturers.

MOON-WILDE

The wedding of Earl Joseph Moon, Jr., of St. Louis, son of Jos. W. Moon, and Miss Dorothy Wilde, younger daughter of Mrs. M. V. Siegel, was solemnized at 4:30 o'clock Wednesday afternoon, June 24, in St. Thomas's Church, New York City, with a full choral service.

The church decorations were white lilies and peonies with palms massed in the chancel, and the ceremony was performed by the Rev. Dr. Frank German, of St. Thomas's Church, Mamaroneck, assisted by the Rev. Mr. Caswell, of St. Thomas's Church.

The wedding was the result of a pretty romance. Miss Wilde first met Mr. Moon less than six weeks ago when the guest of friends in Chicago. It was a case of love at first sight on both sides, and within four days they were engaged. They sailed the following Saturday on the Zealand, going direct to Belgium, where they will be the guests of the Prince and Princess de Croy at the Chateau Billignies, and from there will go to France to visit the Duchess de Talleyrand and the Prince and Princess Murat (Miss Stallo). On their return they will live at Washington Terrace, St. Louis.

CARRIAGE MAKERS CHANCE

That the automobile of a decade hence would show a complete change from the gasoline to the electric type was the prophecy made by Dr. Charles P. Steinmetz, expert of the General Electric Co., before delegates attending the 37th annual convention of the National Electric Light Association in session at Philadelphia. The figures given were startling to those present regarding the coming electric car.

Dr. Steinmetz predicted that ten years from now 1,000,000 moderate-priced electric vehicles, whose approximate price would not exceed \$500, with a 20-mile-an-hour speed and 30 miles or better daily range, would be in operation. He also predicted that the high-powered touring car was to be relegated to the general classification of luxuries, and the gas car of any but the most moderate-priced and compact type would be practically eliminated.

STILL ON THE SAME LAY

The Detroit Trust Co., trustee for the bankrupt Michigan Buggy Co., is now endeavoring to prove that the 50 per cent. dividend voted to Lane and Lay, should be considered an asset of the concern, and the money paid back so as to be distributed among the creditors.

ADDITION TO WORKS

The Troy Wagon Works Co., of Troy, O., is building a handsome three-story addition to its office building. This will practically double the office room. The new addition will contain a three-story fire-proof vault to which entrance may be had from each floor.

PERSONAL

A. T. Jackson has been elected president of the Emerson-Brantingham Implement Co., Rockford, Ill., the distributing house for the Emerson-Brantingham Co., of which Charles S. Brantingham is president. Mr. Jackson has served as general sales manager for the company since its organization and will continue in that capacity in addition to his new duties.

George H. Cox, who has been connected with the motor truck department of the Willys-Overland Co., Toledo, O., since February, has resigned; he will enter the employ of Dodge Bros., Detroit, assisting A. I. Philp in the sales department.

Bruce Daniels, who has been advertising manager of the Stutz Motor Car Co., Indianapolis, Ind., has resigned that position to accept a similar one with the Prest-O-Lite Co. Prior to his connection with the Stutz company, Daniels had been with the Motor Car Mfg. Co.

H. E. Garlent has assumed the duties of general superintendent of the Hupp Motor Car Co., Detroit, Mich. His former connections include service with the Brush company, the Lion Motor Car Co. and the Oakland Motor Car Co.

Maurice Connolly, Dubuque, Ia., at one time active in the Carriage Builders' National Association, has been nominated as democratic candidate for United States senator, and will make the race against Senator Cummins at the election next November.

Harry W. Anderson, who for the past three and one-half years has been affiliated with the American Motors Co., has been made assistant sales manager of the Stutz Motor Car Co., of Indianapolis.

W. H. Frise has been appointed southern Michigan representative for the Tuthill Spring Co., Chicago. His headquarters will be in Detroit.

Victor L. Palmer, formerly secretary of the Michigan Buggy Co., Kalamazoo, Mich., recently convicted of fraud in connection with the affairs of that company, has withdrawn his appeal and asked to be sent immediately to prison. He will serve two years at the federal penitentiary at Leavenworth, Kas.

Louisville manufacturers will take a prominent part in the "Made in Louisville Week," which will be held there beginning August 17. It was inaugurated last year in Louisville and did much to increase the business of the Louisville manufacturers in all lines.

WANT THREE-WHEELED "BATHTUBS" LICENSED

All of those odd little motor-driven vehicles which resemble tricycles and which carry whole families, have come under the censure of the National Highway Protective Society. The society is seeking to have these vehicles licensed just as automobiles are licensed, and Police Commissioner Woods (N. Y. City) has been asked to take measures to that effect.

Frederic R. Coudert, president of the National Highway Protective Society, and Col. Edward S. Cornell, secretary of the society, are behind the move to license the tricycles. Mr. Coudert referred to the fangles as "unlicensed derelicts." The "manufacturers' lobby" at Albany, he said, was responsible for exempting all motor cycles from license. The innovation machines, however, should not come under the exemptions of the law, according to Mr. Coudert. The fact that they carry whole families and take up as much room as automobiles puts these machines in the automobile category.

IMP ADDS FOUR-CYLINDER MODEL

For the coming season the W. H. McIntyre Co., Auburn, Ind., will place on the market a new model of its Imp cyclecar which differs radically from its predecessors. The new car, which is to be ready for delivery early in July, will have a four-cylinder 16 h.p. water-cooled motor and the transmission mechanism will include friction change speed gear and single chain drive to the rear axle, which incorporates a differential of a gearless type; the front springs will be double and the rear springs cantilever members; the wheel base will be 102 inches and with a tandem seated body the car will weigh 750 pounds. The price has been set at \$395 and this includes an engine starter, electric lights and a horn.

UPHELD

Supreme court of Oregon has sustained its former ruling on the validity of the Oregon peddler license law. Some months ago the court approved a conviction of a buggy trailer representing an Iowa concern. The trailer was fined \$150 and ordered committed to jail until the fine should be paid. This judgment was affirmed by the supreme court, but later the case came before that tribunal again on a writ of habeas corpus. It was contended that peddling cannot be predicated on a single sale; also, that inasmuch as the court had held in another case that the law did not apply to persons engaged in interstate business, the act was wholly void. This argument was based upon the theory that the legislature would not have enacted the statute if it could have foreseen that it would be applicable only to persons and property within the state. The court, however, rejected these contentions and adhered to the former decision.

REPETITION

The use of wide tires on wagons has made hauling easier and improved and packed rather than cut ruts in the roads. The farmer who still uses narrow tires for heavy loads is not only wasting time and horse energy, but is guilty of cruelty to animals and the destruction of the public highways. The relation between weight of load and width of tire and the maintenance of roads in each section should be carefully considered and fixed by local regulations. Thus speaketh A. F. Woods, of Jamestown, N. Y.

NONES NON EST

The fight for control of the Kentucky Wagon Mfg. Co., at the annual meeting of the stockholders ended in a victory for the faction led by R. V. Board, president of the concern. The Board adherents controlled the meeting by an overwhelming majority, defeating W. C. Nones, former president, and his following on every issue involved in the contest and electing eight of the nine directors. Mr. Nones subsequently sold all of his holdings.

QUICK WORK

The new John J. Delker Buggy Co. factory in Henderson, Ky., now replacing the burned premises, is ready for occupancy. The old building burned March 18 and on May 18 the formal opening of the new plant began. The new building is larger than the building destroyed.

The Firestone Tire & Rubber Co., Akron, O., is adding 95,000 feet of floor space to its present plant; two wings, one 60 feet wide and the other 140 feet wide, are to be extended 125 feet. A 4,000-kilowatt generator and steam turbine will be installed and the present switchboard will be replaced by a 70-foot gallery board. The company has added to its plant annually for several years.

PATENTS OF INTEREST TO CARRIAGE INDUSTRY

- 1,079,929—Tire preserving compound. S. R. Ball, Laporte, Ind.
 1,080,253—Resilient wheel hub. J. W. Bready, Springfield, Mass.
 1,080,259—Anti-skidding attachment for tires. W. E. Budd, Elizabeth, N. J.
 1,080,416—Tire. W. G. Chipley, Atlanta, Ga.
 1,080,101—Traction vehicle. L. S. Cushman, Los Angeles, Cal.
 1,080,004—Wheel for road vehicles. W. D. Douglas-Jones, London, England.
 1,080,337—Demountable rim. L. A. Gordon, Fall River, Mass.
 1,080,147—Carriage top. L. S. Henderson, Blairs, S. C.
 1,080,447—Tractor system for motor vehicles. A. H. Hoadley, Providence, R. I.
 1,080,361—Motor vehicle. T. F. McAllister, Prineville, Ore.
 1,080,295—Tire. J. J. Patton, New York City.
 1,079,951—Automobile attachment. R. H. Prestien, Norfolk, Va.
 1,080,377—Spring wheel for vehicles. J. F. Sipe, New York City.
 1,080,378—Spring wheel for vehicles. J. F. Sipe, New York City.
 1,080,379—Spring wheel for vehicles. J. F. Sipe, New York City.
 1,079,995—Wheel for motor cars and other vehicles. W. T. Smith, Bolton, England.
 1,080,384—Means for lifting and turning automobiles. McE. Stewart, Kansas City, Mo.
 1,080,385—Tire for vehicle wheels. H. L. Stillman, Westerly, R. I.
 1,080,128—Vehicle wheel. J. J. Van Iderstine, Kansas City, Mo.
 1,080,129—Spring tire for wheels of vehicles. C. H. Vidal, Chiswick, England.
 1,080,394—Tire chain. J. Weaver, Oakland, Neb.
 1,080,033—Storm shield for vehicles. C. F. Wensinger, Fremont, O.
 1,080,035—Wagon. E. M. Wheelock, Winona, Minn.
 1,081,192—Wheel for automobiles and other vehicles. O. H. Attridge, Montgomery, Ala.
 1,080,621—Resilient wheel. J. R. Ayotte, Chicago, Ill.
 1,080,948—Removable wagon cover. C. H. Bigbie, Lone Grove, Okla.
 1,081,010—Automobile tire. E. N. Bretung, Marquette, Mich.
 1,081,012—Blow-out patch. C. E. Brown, Los Angeles, Cal.
 1,081,013—Automobile jack. J. D. Bunn, York, Pa.
 1,081,208—Stop block for vehicles. H. Carduck, Saarbrucken, Germany.
 1,080,812—Storm front for vehicles. J. B. Cretors, St. Paris, O.
 1,080,680—Motor car attachment. A. J. Crist, Amorita, Okla.
 1,081,216—Vehicle wheel. S. A. Currin, Bristol, England.
 1,081,023—Automobile. G. DeFevre, New York City.
 1,080,624—Driving of motor vehicles and similar motor plants. R. Diesel, Munich, Germany.
 1,080,683—Tire shoe making machine. C. A. Edmonds, Akron, Ohio.
 1,080,960—Means for attaching draft bars to sleigh runners. C. M. Erickson, Clarkfield, Minn.
 1,080,818—Automobile tire. A. H. Fisher, Lincoln, Neb.
 1,080,821—Vehicle tire. C. F. Forster, Oak Park, Ill.
 1,081,109—Wagon brake. J. Gibbs, Furrh, Tex.
 1,080,631—Automobile sign holder. H. O. Havemeyer, Mahwah, N. J.
 1,081,269—Spring mounting for go-carts. F. H. Headley, Edgbaston, Birmingham, England.
 1,080,834—Resilient wheel. W. J. Jones, Martinsville, Va.
 1,080,638—Wheel assembler. O. C. Ketring, Portland, Ind.
 1,080,564—Auto jack. C. Knudson, Pontiac, Ill.
 1,081,237—Automobile wheel. J. Kolby, Ephraim, Utah.
 1,080,923—Grip tread for vehicle tires. C. J. Ohlsson, New York City.
 1,081,056—Vehicle body. C. D. Orcutt, North Tonawanda, N. Y.
 1,080,580—Automobile wheel rim. O. L. Pickard, Columbus, O.
 1,080,653—Emergency windlass for automobiles. L. O. Pillsbury, Crocker, S. D.
 1,080,581—Apparatus for raising automobiles. J. J. Preece, Potchefstroom, Transvaal, South Africa.
 1,080,782—Variable speed mechanism for motor vehicles. J. C. Riegel, Pottsville, Pa.
 1,080,591—Front wheel drive and steer for motor vehicles. J. S. Rutkowski, South Bend, Ind.
 1,080,720—Resilient vehicle wheel. L. H. Schoonover, Boise, Idaho.
 1,081,165—Device for automatically lifting and supporting automobiles and other vehicles. T. H. Sparks, Wichita, Kas.
 1,081,166—Foot accelerator for automobiles. O. Spencer, Cuero, Texas.
 1,081,167—Dumping wagon. J. R. Steele, Jr., Owego, N. Y.
 1,080,860—Device for building tires on rims. W. C. Stevens, Akron, O.
 1,081,005—Cushioning device for tires. J. E. Strong, Wilmington, Del.
 1,081,425—Cushion tire. C. E. Bright, Columbus, O.
 1,081,426—Cushion element for resilient tires. C. E. Bright, Columbus, O.
 1,081,812—Tire and rim for wheels. J. B. Crawford, Sioux City, Iowa.
 1,081,587—Vehicle wheel. P. B. Donahoe, Oakland, Cal.
 1,081,372—Vehicle. J. W. Drew, Brackettville, Tex.
 1,081,910—Vehicle gear—L. E. Hickok, Mechanicsburg, Pa.
 1,081,382—Starting means for motor vehicles. R. Huff, Detroit, Mich.
 1,081,757—Vehicle wheel. S. T. Kronenberg, Pittsburgh, Pa.
 1,081,846—Pneumatic tire. J. J. Luck, San Antonio, Tex.
 1,081,683—Automatic circuit controlling mechanism for electrical self starters for automobiles. W. A. Lurie, Chicago, Ill.
 1,081,850—Vehicle brake. R. H. Macfield, Kings Valley, Ore.
 1,081,765—Cushion tire. J. A. Mollitor, Chicago, Ill.
 1,081,551—Resilient vehicle wheel. F. A. Pearl, Madison, Wis.
 1,081,694—Automobile tire protector. F. Persic, Minonk, Ill.
 1,081,698—Vehicle tire. A. S. Richardson, Kenkintown, Pa.
 1,081,628—Cushion wheel. E. H. Schur, Hibbing, Minn.
 1,081,518—Cushion tire for vehicles. J. Seadler, Sacramento, Cal.
 1,081,415—Spring vehicle wheel. C. Warwick, Vancouver, British Columbia, Canada.
 1,081,416—Vehicle wheel. A. R. Weaver, Batesville, Ark.
 1,081,477—Sanding device for automobiles. J. F. Williams, Detroit, Mich.
 1,082,457—Self-propelled vehicle. B. F. Alba, Panama, Panama.
 1,082,479—Automobile rain protector. E. J. Armbruster, Seattle, Wash.
 1,082,299—Demountable rim. R. W. Ashley, New York City.
 1,082,396—Vehicle brake. N. Blanchet, Nye, Ore.
 1,082,410—Automatic vehicle brake. C. C. Cox, Pulaski, Va.
 1,082,415—Automobile fender. J. Didschuneit, Camden, S. C.
 1,082,122—Steering fork for vehicles. J. A. Hill, Essex, Ontario, Canada.
 1,082,026—Motor vehicle. R. Huff, Detroit, Mich.
 1,082,434—Driving wheel for motor vehicles. W. G. Miller, Tarrytown, N. Y.
 1,082,170—Wheel for road vehicles. H. A. Pryor, London, Eng.
 1,082,047—Motor vehicle. L. S. Ross, Newtonville, Mass.
 1,082,449—F. G. Smith, Fitchburg, Mass.
 1,082,367—Tire heater. A. E. Stachel, Chicago, Ill.
 1,082,453—Resilient tire. C. F. Strohm, Carthage, Mo.
 1,082,182—Device for preventing excessive pressure in pneumatic tires. W. H. Van Winkle, Newark, N. J.
 1,083,000—Cushion tire for vehicle wheels. A. Casazza, Hoboken, N. J.
 1,083,188—Tire filler. D. L. Clark, Birmingham, Ala.
 1,083,059—Resilient tire. R. Curry, New York City.
 1,082,504—Motor vehicle. J. Dain, Ottumwa, Ia.
 1,083,245—Vehicle tire. L. H. Ferguson, Ithaca, N. Y.
 1,083,009—Vehicle wheel. F. E. Glasser, New York City.
 1,082,515—Tire heater. J. Gogel, Toledo, O.
 1,082,807—Wheel scotch. H. F. Holworthy, Church Stretton, England.
 1,083,097—Adaptable motor car body. R. H. Hopkinson, Bradford, England.
 1,083,022—Vehicle spring. M. M. McIntyre, Cleveland, O.
 1,082,647—Cushion tire. N. K. Parrish, Gainesville, Fla.
 1,082,900—Resilient wheel. F. F. Patzman, Kansas City, Mo.
 1,082,906—Lock for automobiles and the like. J. E. Potts, Dayton, O.
 1,083,031—Wagon. J. C. Raum, Baltimore, Md.
 1,082,650—Crank for automobile engines. G. W. Redburn, College Place, Wash.
 1,083,143—Tire. W. L. Ross, Bellaire, O.
 1,082,706—Vehicle top raising device. R. Sato, Chicago, Ill.
 1,082,830—Electric heated steering wheel. R. S. Smith, Marshall, Tex.
 1,082,660—Inner tire. J. A. Thompson, Allentown, Pa.
 1,083,231—Making tires. A. E. Wale, Birmingham, England.
 1,083,584—Air tube for pneumatic tires. W. R. Blowers, Toronto, Canada.
 1,083,657—Clevis for whiffle trees. P. H. Boice, Franklinville, N. Y.
 1,083,797—Automobile seat. S. E. Brown, Kenosha, Wis.
 1,083,798—Automobile tire. C. U. Butts, Boston, Mass.
 1,083,273—Folding top for vehicles. A. N. Chenweth, Waterbury, Conn.
 1,083,875—Fixing rubber or other tires on wheels. T. K. Clark, Durban, Natal, South Africa.
 1,083,730—Driving mechanism for motor vehicles. F. Collichonn, Frankfort-on-the-Main, Germany.
 1,083,670—Resilient tire for vehicle wheels. D. H. Donachy, Williamsport, Pa.
 1,083,440—Tire inflating apparatus. O. Ebert, Ironton, O.
 1,083,276—Wind shield. F. J. Falter, Norwalk, O.
 1,083,399—Steering mechanism for vehicles. J. E. Hanger, Jr., Atlanta, Ga.

- 1,083,613—Starting mechanism locking means for automobiles. E. T. Hope, Philadelphia, Pa.
 1,083,330—Motor vehicle. V. Link, Detroit, Mich.
 1,083,886—Shoe attachment for automobile wheels. J. W. Martson, Jr., Mobile, Ala.
 1,083,847—System for inflating pneumatic tires. C. P. McDowell, Winlock, Wash.
 1,083,892—Resilient wheel for road vehicles. A. M. de Palacio y Garcia, Alfajar, Spain.
 1,083,293—Pneumatic tire. J. F. Palmer, Riverside, Ill.
 1,083,701—Speed control for self propelled vehicles. W. J. Perkins, Grand Rapids, Mich.
 1,083,632—Tire. P. Richter, Berlin, Germany.
 1,083,562—Non-puncturable pneumatic tire. E. F. Rolff, Sacramento, Cal.
 1,083,864—Resilient vehicle wheel. P. H. Shailer, Sydney, New South Wales, Australia.
 1,083,513—Vehicle wheel. C. F. Womeldorf, Washington, D. C.
 1,083,312—Autosled. M. Weidner, Lake Henry, Minn.
 1,083,644—Non-skidder. W. Wenom, Kirkwood, Mo.
 1,083,869—Non-skid tire shoe. H. Strongson, New York City.
 1,083,709—Vehicle wheel. G. F. Tadini, New York City.
 1,084,056—Spring tire. H. J. Augustine, Independence, Kas.
 1,084,144—Automobile wheel. E. G. Glaser, North Dover, O.
 1,084,207—Automobile sleigh. R. F. Goy, Freesburg, Pa.
 1,084,084—Transmission mechanism for motor vehicles. G. Guerra, Washington, D. C.
 1,084,430—Vehicle steering device. T. S. Harris, Waverly, Ill.
 1,084,434—Tire protector. F. Holik, Prague, Okla.
 1,084,090—Vehicle spring. C. L. Jordan, San Francisco, Cal.
 1,084,446—Automobile chassis. C. C. Keyser, Pensacola, Fla.
 1,084,283—Motor vehicle. C. B. Lord, St. Louis, Mo.
 1,084,025—Tire. J. McNamee, Amsterdam, N. Y.
 1,084,470—Pneumatic puncture proof tire. F. Newbauer, Valley City, N. D.
 1,084,458—Wagon. H. Pezzetti, Philadelphia, Pa.
 1,084,237—Lock for automobile clutch levers. G. P. Smith, St. Louis, Mo.
 1,084,302—Vehicle wheel. D. T. Timberlake, St. Louis, Mo.
 1,084,303—Spring vehicle wheel. D. T. Timberlake, St. Louis, Mo.
 1,084,567—Steering gear connection for motor vehicles. U. A. Towle, Portland, Me.
 1,084,050—Rim for vehicle wheels. H. K. Wheelock, Akron, O.
 1,084,187—Runner attachment for auto vehicles. C. A. Wiberg, Chicago City, Minn.
 1,083,976—Vehicle wheel. A. R. Wylie, Big Spring, Tex.
 1,084,844—Steering gear for automobiles. W. A. Campbell, Maricopa, Cal.
 1,084,789—Vehicle tongue. B. Claypool, Kitanning, Pa.
 1,084,731—Resilient tire. D. H. Deery, Bridgeport, Conn.
 1,084,620—Vehicle wheel. E. T. Forrester, Denver, Col.
 1,085,038—Wagon reach. S. A. Hall, Cameron, W. Va.
 1,084,644—Whiffletree attachment. J. Lee, Otterville, Ill.
 1,084,864—Tire. C. M. Lloyd, London, England.
 1,084,866—Solid tire for vehicles and the like. D. Maggiora, London, England.
 1,084,648—Resilient vehicle wheel. C. J. Malings, Easthampton, Mass.
 1,084,890—Warming device for automobile steering wheels. F. E. McCrory, Los Angeles, Cal.
 1,084,895—Pneumatic tire casing repair device. J. N. Newsom, St. Louis, Mo.
 1,084,819—Cushioned suspension for vehicles. W. L. Peltz, Selkirk, N. Y.
 1,084,820—System of transporting heavy loads by motor vehicles. T. Pescatore, Liege, Belgium.
 1,084,959—Transmission gearing for motor vehicles. J. S. Peters, Scottdale, Pa.
 1,084,976—Vehicle brake. A. J. Stetler, West Point, Pa.
 1,084,912—Transmission shaft for automobiles. W. E. Trufant, Whitman, Mass.
 1,084,997—Automobile sleigh. W. J. Wright, Manitoba, Can.
 1,085,376—Tire. F. S. Byington, Los Angeles, Cal.
 1,085,545—Tire. H. Cooney, Marion, Ind.
 1,085,324—Demountable rim. J. Craig, Bedford, England.
 1,085,113—Wind shield. P. DeAnguera, Jr., Chicago, Ill.
 1,085,408—Automobile tire. W. E. Delehanty, New York City.
 1,085,281—Wind shield. M. D. Maremont, Chicago, Ill.
 1,085,350—Vehicle body. H. H. Marker, Mount Clemens, Mich.
 1,085,154—Mud shedder for vehicle wheels. H. G. Newsom, Boyce, Tex.
 1,085,471—Latch for automobile doors. R. Ochsner, New Haven, Conn.
 1,085,501—Motor vehicle. D. M. Smith, Washington, D. C.
 1,085,176—Vehicle. J. C. Smith, Elyria, O.
 1,085,513—Vehicle wheel. G. R. Williams, Little Rock, Ark.

Designs

- 45,148—Vehicle tire. G. W. Daum, Jeanette, Pa.
 45,166—Tire casing. L. P. Destribats, Trenton, N. J.
 45,105—Motor truck body. G. B. Francis, New York City.
 45,107—Tire tread. J. R. Gammeter, Akron, O.
 45,131-2—Automobile or carriage bow separator. C. E. Titchener, Binghamton, N. Y.
 45,097—Automobile truck wheel. G. Wather, Dayton, O.
 45,092—Tire tread. A. Johnston, Edingurgh, Scotland.
 45,090—Rubber vehicle tire. W. C. Hendrie, Los Angeles, Cal.
 45,083—Automobile tire. A. K. Allen, Seattle, Wash.
 45,050—Tire tread. H. K. Raymond, Akron, O.
 45,051—Tire tread. E. C. Shaw, Akron, O.
 45,021—Vehicle body. E. H. Remde, Cleveland, O.
 Copies of above patents may be obtained for 15 cents each, by addressing John A. Saul, Solicitor of Patents, Fendall, Bldg., Washington, D. C.

NOTHING, NOT EVEN PSYCHOLOGY, STOPS THEM

The two largest employers of labor about Owensboro, the Owensboro Wagon Co., with its 300 men, and the Ames company plants, which reaches to nearly 400, have been going at capacity speed for a long time. The last named factory has been operating until 9 o'clock in the evening, except on Saturday, thus adding two more hours to the working day.

GOODRICH AIMING AT 2,000,000 TIRE OUTPUT

There is a good possibility that this year's output of tires by the B. F. Goodrich Co. will run into the second million. "Two Million Tires" is the Goodrich slogan. At present the company is producing an average of 10,000 tires a day, which is at the rate of 3,000,000 a year. The Akron plant of the company are now running 24 hours a day.

THROWING OUT IMPLEMENT, THROWING IN MACHINERY GEAR

The Greater Michigan fair building heretofore used for a carriage building will be given a cement floor and divided into 80 stalls for the display of moving machinery with electric power. The carriages will be displayed under tents on the ground.

DAMAGES WANTED

The creditors' committee of the Columbus (O.) Buggy Co. has been sued by F. S. Monnett for \$700 damages for withdrawal of certain terms of a contract for the purchase of an electric automobile, whereby it was to be kept in repair and charged with electricity for a year after its purchase.

HALE BARBECUE

Appreciation of faithful service and the breaking of all records in output for the previous month was the motive for a barbecue tendered in May by the Hale Buggy Co. to its employes, in Anniston, Ala.

NEW SELLING ARRANGEMENT

The Parry Mfg. Co. has completed arrangements with the J. I. Case Plow Works, under the terms of which the salesmen of the latter in Nebraska and western Iowa will sell the Parry line of vehicles.

VALUE OF SECOND-HAND VEHICLES

A recent ruling regarding the valuation of second-hand carriages imported into Canada requires that the amount declared on the invoice, and on which duty must be paid, shall be 50 per cent. of the original value.

Trade News From Near and Far

BUSINESS CHANGES

Carriage and Wagon

Leeds, N. D.—J. Kjelmer succeeds J. Schultz.
 Springfield, Vt.—W. S. Kimball, livery, retired.
 Concordia, Kas.—A. C. Little, retired from business.
 Creighton, Neb.—Dewey & Wilson succeed A. J. Roe.
 Miller, Neb.—Marvin Robinson succeeds I. I. Noble.
 Belsidere, Neb.—J. Reinholtz succeeds T. D. Loverick.
 May, Okla.—H. A. Smith succeeds R. J. Maurer & Co.
 Bixby, Okla.—C. Sample succeeds Sample & Henderson.
 La Crosse, Wash.—Chas. Dazell succeeds Dazell & Moore.
 Bryant, Ia.—Henry Hagge, vehicles, succeeds A. Monahan.
 Lake Odessa, Mich.—Chas. A. Lapo succeeds Fender & Lapo.
 Hickman, Neb.—D. Steel succeeded by Bachmann & Freye.
 Conrad, Mont.—Power-Wilson Co. succeeds Peterson Bros.
 Brashear, Mo.—Patterson Bros. succeed Conway & Edmunds.
 Winnebago, Neb.—Morgan & Conley succeeds L. A. Mercur.
 Camp Douglas, Wis.—J. H. Buffington succeeds C. H. Horton.
 Prescott, Ia.—T. M. Johnson succeeds Bohanan & Johnson.
 Mexico, Mo.—E. E. Cantrell, vehicles, succeeds J. W. Dry.
 Mankato, Minn.—R. Foegel, repairs, moved into new quarters.
 Pompeii, Mich.—Earl Derry, vehicles, succeeds Peters & Wood.
 Ness City, Kas.—Taylor Mercantile Co. succeeds Temple & Taylor.
 St. Johnsbury, Vt.—J. H. Ryan sold carriage shop to W. A. Wright.
 Miami, Neb.—Coleman-Harvey Buggy Co. succeeds Pierce & Harvey.
 Burlington, Vt.—G. B. Arnold bought trucking business of C. C. Niles.
 San Antonio, Tex.—Woodward Carriage Co. will move into new building.
 Dixon, Neb.—A. E. Oswald, vehicles, purchased stock of A. L. Fletcher.
 Earling, Ia.—R. Ford & Sons, implements and autos, sold to A. Stinn & Son.
 Waco, Tex.—B. Garber has bought Texas Carriage Co. business. Will run it.
 Wolfeboro, N. H.—Henry O. Trafton retires from carriage painting business.
 Maywood, Mo.—Lee Brinkley has purchased vehicle business of C. L. Spaulding.
 New Castle, Ind.—John Tuell, vehicles, purchased stock of J. C. Ferrier & Son.
 Ft. Worth, Tex.—Ft. Worth Wagon Mfg. Co. has purchased Ft. Worth Wagon Factory.
 Trenton, N. J.—Jacob S. Valentine, many years carriage builder, is retiring. Factory for sale.
 Farley, Ia.—J. Z. Benedict has moved factory to Cedar Rapids, where he will continue making "All-in-One" cart.
 Sioux Falls, S. D.—Dakota Plow & Wagon Co. Receiver appointed. Was consolidation of Sioux Falls Plow and Iowa Wagon companies.
 Peoria, Ill.—The R. Herschel Mfg. Co. has purchased the plant formerly occupied by J. A. Engel & Co., who were adjudged bankrupt. The Herschel company will make singletrees, doubletrees, wagon boxes, wagon seats and other wooden articles.

Automobile

Whitewater—W. J. Taft, garage, sold to Mason & Kraeplin.
 Ashland, Neb.—E. K. Reese, garage, sold to W. & H. Smyth.
 Toledo, O.—R. G. Howard is going to build light auto truck.
 Indianapolis, Ind.—R. H. Colburn, garage, sold to H. K. Storment.
 Grand Rapids, Mich.—Reid Auto Co. succeeds Reid-Bleckley Auto Co., dealers.
 DePere, Wis.—J. J. Hallett doing business as DePere Motor Car Co., failed; liabilities \$1,065.74, assets \$460.64.

NEW FIRMS AND INCORPORATIONS

Carriage and Wagon

Jasper, Mo.—Ellis Carnal, vehicles.
 Exeter, N. H.—H. Carter. Repairs.
 Leon, Ia.—E. W. Hamilton, vehicles.
 King, N. C.—J. H. Truelove, vehicles.
 Langdon, N. D.—Jos. Kartes, vehicles.
 Hesper, Mont.—Phelan Bros., vehicles.
 Neola, Ia.—R. J. Schierbrock, vehicles.
 Detroit, Mich.—Auto Repair Co. \$5,000.
 Amidon, N. D.—T. J. Haggerty, vehicles.
 Westhope, N. D.—D. H. Curran, vehicles.
 Fox Lake, Mont.—W. C. Howard, vehicles.
 Manhattan, Kas.—Pitman & Lowe, vehicles.
 Greencastle, Ind.—A. G. Broadstreet, vehicles.
 Hawick, Minn.—M. P. Loberg, vehicle hardware.
 South Haven, Kas.—H. T. Warrenstaff, vehicles.
 Stanton, Neb.—J. Benne, vehicles and implements.
 Strubble, Ia.—Hauff Bros., vehicles and implements.
 Hanson, Neb.—J. L. Berg, vehicles and implements.
 Bigfork, Mont.—Montgomery & Warnock. Repairing.
 Campbell, N. Y.—Joint Bros., implements and vehicles.
 Suqualena, Miss.—Holbert & Renfro. Spoke factory.
 Coffeyville, Kas.—Chas. Christ, vehicles and implements.
 Yerba Linda, Cal.—R. A. Shook and W. E. Ware, vehicles.
 Dysart, Ia.—A. C. Ryan & Co. Building vehicle repository.
 State Line, Ind.—John Q. Allison, vehicles and implements.
 Clarissa, Minn.—Morey & Nutting, vehicles and implements.
 Miami, Okla.—Coleman-Harvey Buggy Co. Capital \$4,000.
 Plankinton, S. D.—R. V. Fitzgerald, vehicles and implements.
 Bloomfield, Neb.—Lux & Colburn, vehicles and implements.
 Chicago, Ill.—Jos. Zarzembowski, Inc., livery. Capital \$35,000.
 Ansley, Neb.—E. A. Butler & Son. Again engaged in vehicle trade.
 Clo, Idaho—Star Hardware & Implement Co. Capital \$10,000. Will sell vehicles.
 Fayetteville, Ark.—Phillips Hardware Co. Capital \$16,000. Will handle vehicles.
 Mayville, N. D.—Elmer Cotton & Son, of Grand Forks, have opened new stock here.
 Mountain Lake, Va.—Mountain Lake Livery Co. Capital \$5,000. J. T. S. Hodge, T. J. Porterfield.
 Ft. Smith, Ark.—Ft. Smith Vehicle & Machinery Co. Capital \$5,000. J. B. Williams, V. Thomblin, N. C. Meals.
 Memphis, Tenn.—Schley Carriage & Wagon Co. Capital \$5,000. C. W. Schley, H. H. Honnell, W. W. Swift.
 Westchester, N. Y.—Ashley Wire Wheel & Rim Co. Capital \$50,000. Directory, N. Y. City people, names not supplied.
 Moline, Ill.—Tiger Vehicle Co. Capital \$100,000. F. G. Allen, A. C. Barber, C. R. Stephens, C. A. Bebiesler, L. C. Blanding.

Fostoria, O.—Peabody Vehicle Co. Capital \$10,000. W. O. Allen, G. E. Schroth, J. E. Wright, E. W. Allen, A. E. Wyant.
Toledo, O.—Tillotson Mfg. Co., vehicles. Capital \$25,000. R. C. Tillotson, R. R. Scott, W. Stewart, H. L. Shepler, L. C. Vanbevar.

Clarksburg, W. Va.—Jackson Carriage and Auto Co., wagons and buggies. Capital \$10,000. D. R. Michael, Anthony J. Schulte, Ed. M. Gilmore, J. M. Shields, John M. Schulte, all of Clarksburg, W. Va.

Automobile

Rising City, Neb. E. E. Reece, garage.
Holland, Mich.—Spenny Motor Car Co.
Raleigh, N. C.—Wake Auto Co. Capital \$25,000.
Buffalo, S. D.—V. E. Davis & Emil Lund, garage.
Indianapolis, Ind.—Power Car Co. Capital \$15,000.
Chicago—Duryea Motor Sales Co. Capital \$100,000.
St. Louis, Mo.—Jeffrey Motor Car Co. Capital \$4,000.
Minneapolis, Minn.—Dayton Cyclecar Sales Co. Dealers.
Liverpool, O.—Liverpool Motor Car Co. Capital \$10,000.
St. Louis, Mo.—Vesper-Buick Co., dealers. Capital \$50,000.
Kansas City, Mo.—Hall Bros. & Reeves Motor Co. Capital \$5,000.

New Orleans, La.—Acme Automobile Co., dealers. Capital \$18,000.

Hibbing, Minn.—Range Motor Service Co., dealers. Capital \$50,000.

Cincinnati, O.—Auto Livery Co. Capital \$1,000. W. C. Jungelas.

Boston, Mass.—Cadillac Auto Co. Capital \$100,000. A. L. Dafforth.

Boston, Mass.—L. M. Cotton, inc. Capital \$50,000. F. E. Crawford.

Cincinnati, O.—Main Auto Machine Co. Capital \$5,000. G. D. Haynes.

Cleveland, O.—Euclid-Penn Auto Supply Co. Capital \$20,000. E. T. Cravin.

Louisville, Ky.—Sampson Engineering Co. Capital \$350,000. Auto starters.

Newark, N. J.—Booraem-Nichols Motor Car Co. Capital \$100,000. H. H. Booraem.

Chicago, Ill.—Esplanade Garage & Supply Co., Inc. E. W. Roemer, A. Ryan, J. J. Bittourns.

St. Louis, Mo.—Car-Nation Motor Car Co., dealers. L. F. Ottofy, O. Guitar, Jr., F. B. Ottofy.

Olympia, Wash.—Olympia Garage Co. Capital \$6,000. N. W. Nottinger, J. B. Ethom, E. Mallory.

Indianapolis, Ind.—American Underslung Co. Capital \$50,000. E. Duncan, C. M. Brown, A. D. Ogborn.

Indianapolis, Ind.—Cyclops Cyclecar Co. Capital \$10,000. J. W. Smith, J. W. Ferree, C. A. Hargrave.

Indianapolis, Ind.—Gates Mfg. Co., auto parts. Capital \$20,000. F. E. Gates, F. O. Lane, R. A. Gates.

Chicago, Ill.—Flex Spring Co. Parts. Capital \$5,000. T. E. Beman, A. F. Mecklenberger. W. B. Sawyer.

Muskogee, Okla.—W. R. Lantz Car & Auto Co. Capital \$25,000. W. R. Lantz, A. E. Lantz, J. O. Humphries.

Chicago, Ill.—L. & M. Co. Capital \$10,000. Autos and accessories dealers. C. A. Larson, L. Teubner, Svea Thorsell.

Orange, N. J.—Coppinger Motor Car Co., dealers. Capital \$5,000. F. W. Coppinger, J. R. Monroe, H. G. Dechant.

Chicago, Ill.—Chicago Auto Radiator Mfg. Co.; to manufacture and repair radiators, fenders and motor car sheet metal work.

Cleveland, O.—Alday Mfg. Co., motors and engines. Capital \$10,000. H. A. Hauxhurst, M. T. Flanagan, F. X. Cull, R. Inglis, V. Svancar.

Columbus, O.—Dunlap Electric Truck Co. Capital \$20,000. T. C. Dunlap, G. R. Hedges, T. A. Hoover, H. B. Tingley, M. E. Heasley.

NEW COMPANIES

Columbus, O.—Dunlap Electric Truck Co.; capital \$20,000; to manufacture and deal in electric motor trucks, vehicles and accessories.

Nashville, Tenn.—Nashville Tire Co.; to deal in tires, tubes and accessories.

Saginaw, Mich.—Saginaw Motorcar Co.; to manufacture cyclecars.

New Orleans, La.—Southern Cyclecar Mfg. Co.; to manufacture cyclecars.

Chicago, Ill.—American Efficiency Survey of Motor Car Units; to analyze constituent parts of motor cars and pass on their efficiency. Corporators—Harry Newman, Kenyon W. Mix, David Minard Shaw and Charles S. Castle.

Columbus, O.—Auto Combination Switch Lock Co.; capital \$10,000; accessories. Corporators—H. R. Elliott, C. E. Dennis, L. A. Van Anda, L. M. Van Anda, E. B. Dennis and Edward Dennis.

Dover, Del.—Oil & Waste Products Co.; capital \$100,000; to deal in motor car supplies, oils, greases, gasoline, etc. Corporators—J. M. Satterfield, Dover; H. O. Coughlan and H. F. Kleist, both of New York City.

Esopus, N. Y.—Simpson Garage; capital \$1,500; garage, motor car supplies, tires, etc.

Keyport, N. J.—A. C. Squires Rubber Co.; capital \$125,000; rubber goods of all kinds. Corporators—A. C. Squires, C. S. Ackerson and A. E. Sculthorp, all of Keyport.

Freeport, N. Y.—Forbes Rubber Co.; tires, rubber goods, etc. Corporators—Thomas P. C. Forbes, Jr., George V. Sloat and Anna S. Sloat, all of Freeport.

Portland, Me.—China Vehicle Co., Ltd.; capital \$150,000; to manufacture and deal in vehicles of all kinds. Corporators—J. N. Pierce and R. O. Brewster, both of Portland.

New York, N. Y.—Portage Rubber Co.; capital \$1,000; motor car and bicycle tires, etc. Corporators—E. P. White, W. W. Wildman, Akron, O.; Joseph F. Curtin.

Buffalo, N. Y.—Bigger Rubber Preservative Co.; capital \$10,000; to treat rubber by "Bigger process." Corporators—A. Frank Bigger, Wm. J. Connors and Walter F. Hocheins.

White Plains, N. Y.—Ashley Wire Wheel & Rim Co.; capital \$50,000.

Gloversville, N. Y.—Auto-Comfort Robe Co.; capital \$25,000; to manufacture robes, blankets, etc. Corporators—Fanni G. Mildredth, Luzerne W. Rourk and Elysses C. Patterson, all of Gloversville.

NEWS BRIEFS

The Troy Wagon Works Co., Troy, O., is building a three-story addition to its office building.

Teatus Davis, who travels in Alabama and Mississippi for the Parry Mfg. Co., of Indianapolis, was married May 24 to Miss Erma Winter, of Water Valley, Miss.

The Tillotson Mfg. Co. has been incorporated at Toledo, O., capital stock of \$25,000, for the purpose of manufacturing vehicles. The incorporators are R. C. Tillotson, R. R. Scott, Walter Stewart, H. L. Shepler and L. C. Vanbevar.

It is reported that the Owensboro Wagon Co., Owensboro, Ky., has sold \$85,000 worth of preferred stock to people of Owensboro, resulting from efforts to induce the company to move to Evansville, Ind.

The Virginia Auto Supply Co., Richmond, has been established. Kelly-Springfield tires will be stocked.

The United Tire Co. has started at 128 East New York street, Indianapolis, Ind., for the sale of seconds tires and tubes.

The I. J. Cooper Rubber Co., Cincinnati, O., has opened a branch in Indianapolis at 219 West Vermont avenue. The company distributes Racine and Motz tires and tubes.

The Arbogast Tire & Vulcanizing Co., Toledo, O., is located at 124 Erie street and will carry a stock of tires and supplies.

The Northeastern Cyclecar Co. has been organized in Youngstown, O. It has located at 1439 Kensington avenue and is handling cyclecars.

The plant of the Eckhart Carriage Co., Auburn, Ind., was slightly damaged by fire recently. The fire did not interfere with the manufacturing operations of the company.

Plans for the establishment in Los Angeles of a factory for the manufacture of Mack and Saurer trucks are under consideration by the International Motor Co., New York City. The proposed plant would employ about 300 men and would furnish commercial vehicles for the Coast and points within a logical shipping radius of the factory.

The Keystone Wagon Co., of Keystone, W. Va., has been incorporated with a capital stock of \$10,000 for the purpose of manufacturing farm and other wagons. It will probably construct its own building and equip its plant. The incorporators are C. C. Hale, W. E. Stewart, V. M. Parker, Minnie B. Parker and B. B. Harrison, all of Keystone.

The Auto Tire & Rubber Works has been formed in Ogden, Utah. It has located at 2655 Washington avenue and will repair tires for the present, although it plans to build tires later.

MANUFACTURERS' NOTES

The Weston-Mott Co., Flint, Mich., is closing a very successful year, the volume of its business being greater than ever in the history of the concern. Not only does the Weston-Mott Co. supply axles, rims and hubs to car manufacturers in the General Motors group, of which it is a part, but it also does a big business with outside concerns.

The United Motor New York Co., the old United States Motor Co.'s New York branch corporation, has dissolved; following the taking over of the United States Motor by the Maxwell Motor Co. the dissolved corporation has been inactive.

REFEREE SAYS KELLY-SPRINGFIELD CAPITAL MAY BE INCREASED

A referee has decided that the Kelly-Springfield Tire Co. might place in operation the financial plan recently proposed to shareholders and opposed by a New York broker. The plan calls for the exchange of the company's outstanding \$2,850,500 4 per cent. debentures into 6 per cent. cumulative preferred stock and for the payment of 78½ per cent. of back dividends on the stock in shares of a new issue of 7 per cent. second preferred stock.

Counsel for the company states that almost all of the bondholders have already deposited their holdings with the Bankers' Trust Co. The company's capital will be increased to \$10,299,000 from \$5,149,000.

NEW JOB

John D. Hollowell, for the past two years sales manager for the Moline (Ill.) Wagon Co., has been named as general manager of the Mitchell Wagon Co., of Racine, Wis. Mr. Hollowell assumed his duties on the first day of June.

He is well known to the wagon trade of the country and especially around Rock Island, Ill., where he has lived the past year.

OLD KING COLE HAS A LITTLE SIX

Supplementing its larger six-cylinder model and the new four-cylinder model, the Cole Motor Car Co. has added a little six model which sells for \$1,865. At the same time, the price of the big six, which was \$2,600, has been reduced to \$2,465.

The little six is new throughout, and but one important alteration has been made in the big six.

PRINTED MATTER RECEIVED

A striking circular has been received from the Monarch Mfg. Co., of Dayton, O., describing the Dayton welding and decarbonizing plant for welding broken metal and removing carbon. From the description, this would be a most useful outfit of machinery in a carriage or wagon shop or other institutions that cater to machinery repairing.

NEW KNOX STARTS ON BUSINESS PLAN

By a decision in the U. S. District Court of Massachusetts, the last question in the transfer of the old Knox Automobile Co. to the new Knox Motors Co. has been settled. Judge Morton has confirmed the sale of the entire plant and property to E. O. Sutton, of Springfield, who is now treasurer of the new company.

ASKS FOR CATALOGS

C. B. Cozart has purchased the stock of the Dilworth Hardware Co. at Wichita, Kas., and asks for catalogs.

Keystone Wagon Co., Keystone, W. Va., want catalogs of factory supplies and accessory lines. A new concern.

The General Motors Truck Co., of Pontiac, Mich., has just issued a catalog of its line of electric trucks. This book reflects credit upon the company's new advertising manager, James E. Baird. It answers every question that might be asked by one who contemplated the purchase of an electric truck. It is a presentation of facts relating to the necessity of motor trucks, the distinctive features of the GMC electrics and the specifications of the eight sizes made by the company. The book is illustrated with photographs of trucks in use and feature parts of the GMC line.

The Garage Equipment Mfg. Co., Milwaukee, Wis., plans to go extensively into the manufacture of cyclecar parts; it is already making deliveries on wind shields, brackets, lamps, mufflers, pedals, levers, steering columns and pulleys, and is bringing out a shaft drive rear axle for narrow treads. The company has secured as factory manager G. W. Thexton, formerly with the Lewis Spring & Axle Co., Jackson, Mich.

F. L. Warrington, secretary of the Illinois Retail Implement and Vehicle Dealers' Association, announces that the board of directors has endorsed the Merchant's Underwriters of Chicago and Kansas City as the official fire insurance organizations of the association. The Merchants' Underwriters started in 1907. The business is handled on the reciprocal plan, subscribers paying board rates and receiving dividends. Mr. Warrington states that the average savings of members thus far has been about 40 per cent.

The Kindling Machinery Co., of Milwaukee, Wis., is mailing to the trade a catalog illustrating a street washing machine, showing the attachment on various styles of wagons. It is called "The Kindling Squeegee." This company also makes a sand spreader. The equipment manufactured by this concern will help solve the problem of cleaning our city streets and the promotion of good roads.

Warren D. Oakes, president of the Oakes Co., Indianapolis, manufacturer of radiator fans and automobile parts in pressed steel, sailed for Europe June 8. While abroad Mr. Oakes will call on the principal manufacturers in Great Britain and Europe, with a view of opening up business relations for his company. Mr. Oakes is a son-in-law of D. M. Parry, and well known in the carriage trade.

O B I T U A R Y

W. H. Adkinson, manager of the Florida Hickory & Wagon Works, and a prominent business man, was instantly killed by lightning during a thunderstorm in Tampa, June 14. Mr. Adkinson had just entered his office and picked up the receiver on his telephone when the bolt struck. The effect of the lightning was transmitted to Mr. Adkinson through the medium of the 'phone and he fell back dead. He leaves a wife and several small children.

Mark Washington Ball, an old-time resident of Newark and one of the oldest citizens of New Jersey, died May 21, at the home of his daughter, Mrs. Mary E. Omberson. Mr. Ball, who was in his 96th year, enjoyed the use of his faculties to the last. Up to ten days ago Mr. Ball was in perfect health. His business was that of a carriage maker and he built the first wagons and wheel-barrows that were used in California during the gold hunting days of 1849. These vehicles were sent to the Pacific Coast by ships around Cape Horn, and the trip took six months. He was endowed with a wonderful memory and often told of his meeting with General Lafayette during the French soldier's visit to this country in 1824. The meeting took place on the doorstep of Trinity Episcopal Church and the general kissed him.

W. R. Belknap, chairman of the board of directors of the Belknap Hardware and Mfg. Co., Louisville, Ky., and former president of the concern, died at his home in that city. Mr. Belknap had been ill for several weeks following the death of his sister, but had been in ill health since 1910, at which time he gave up the presidency of the company. At the time of his death Mr. Belknap was 65 years old. He held the presidency of the company for over 25 years.

James J. Drown died June 3 at the home of his brother, in Lyndon, Vt., following several months of failing health and a shock. Mr. Drown was born in Brownington 76 years ago. About 50 years ago he married Adeline Moore. They had one son, Fred E. Drown, of St. Johnsbury, who survives him. Mr. Drown early in life moved to Glover where he learned the wheelwright's trade. He worked in carriage making there, in Barton, Lyndon and St. Johnsbury for many years. He was 21 years a valued employe of the Miller & Ryan factory in St. Johnsbury.

Joel Fenn, Meriden, Conn., for many years identified with the carriage building business, died at his home, of pneumonia. He was born in Wallingford, 1851. In 1865 he went to Meriden and received his education in the Meriden schools. Later, he was associated with his father in the firm of Joel Fenn & Sons. In 1877 he married Katie J. Forbes, who survives him. The couple had two sons, Burton W. Fenn, who has been associated with his father in business, and Hamlin S. Fenn. In 1887 Mr. Fenn bought out a half interest in the carriage business of Walter J. Chalker, and a few years ago purchased the remaining half interest and has carried on the business since under the name of Chalker & Fenn.

John Hollyman, formerly a manufacturer of wagons at Hannibal, Mo., passed away at the home of his daughter, Springfield, Ill., recently. Deceased was born in Lexington, Ky., in 1833. He had resided in Hannibal about 70 years and was engaged with his son, W. E. Hollyman, in the manufacture of wagons. He retired from business in 1896. Four children survive him.

John Kaufman, aged 76, of 1206 East street, Pittsburgh, Pa., for 49 years a wagon builder of the North Side, died May 18. He leaves his widow, Mrs. Margaret Kaufmann; three sons, Louis, Emil, and John, a daughter, Mrs. Harry Westernan, and two brothers, Adam and William Kaufmann.

Henry F. Kroeger, 79, a retired carriage manufacturer, died at Cincinnati, after a lingering illness. Until his retirement he had a carriage manufactory on Central avenue. He was born in Germany and went to Cincinnati in 1852. He leaves a son and a daughter.

Deokar Laitsch, aged 69, died in Pittsburgh, June 15. He was born in Germany and went to Pittsburgh in 1872, when he engaged in business in the firm of Laitsch & Gerst, wagon makers. He is survived by four sons, Andrew, Frank, Joseph and John, and five daughters.

A. J. Meyers, member of the firm of A. Meyers' Sons, carriage and wagon manufacturers, Richmond, Va., died in Asheville, N. C., June 5, after a protracted illness. He leaves, besides his widow, a brother, Charles W. Meyers, who was his partner in business, and two sisters.

John C. Raum, senior member of the firm of John C. Raum & Son, wagon manufacturers and makers of automobile tops, 405-407 Sharp street, died at his home, 717 McHenry street, Baltimore, Md., of a complication of diseases. He had been ill for 14 weeks. Mr. Raum was 67 years old. He was a blacksmith by trade and in 1898 he established the wagon making business with his son, John J. Raum, as junior member of the firm. He remained active in the business until his illness early in the year. Besides his son, he is survived by a widow and a daughter.

Henry Shafer died at Mercy Hospital, Hamilton, O., June 9. He was born in Collinsville, April 3, 1862. In 1894 he and his brother went to Hamilton and engaged in the agricultural implement business. While he retained his interest in the partnership, he was only actively engaged for two years, having been appointed under the second administration of Grover Cleveland, June, 1895, as gauger in the United States revenue service, a position he held until the time of his death.

Garret Shover, of Indianapolis, died June 8 at his home. Mr. Shover ran a wagon and buggy shop, and for years made a specialty of building very heavy wagons. Some of these he sold to South American firms. He was a veteran of the civil war.

William C. Sunderland, 86 years old, died at Providence, R. I. He had been in failing health for the past two months. Mr. Sunderland had been connected with Allen Greene & Son, carriage builders, for more than 40 years. He was born in Pawtucket.

Emanuel Wehr died of Bright's disease at his home at Best's, Pa., aged 80 years. He was a carriage maker by trade.

NECROLOGY

E. M. Dill, late manager of the credit department of Berry Bros., Inc., Detroit, Mich., passed away recently, after an illness of only one week. Mr. Dill had been in charge of that department for six and a half years and seemed to be peculiarly fitted for the exacting duties and responsibilities of his position.

Joseph F. Firestone, vice-president and superintendent of the Columbus Buggy Co. prior to its receivership, then manager of the Columbus Auto Sales Co., Columbus, O., is dead. The precise circumstances under which he died in all probability will forever remain a mystery. That he was burned to death May 18 in his Fourth street place of business, and that it was an intense gasoline fire that killed him are facts known, but how the fire started is the mystery that likely is to remain unsolved. Mr. Firestone was 52 years old. He was financially interested in the Park Savings Bank and was vice-president of that institution. Mrs. Firestone and a daughter, Miss Anita Firestone, survive.

The Dauch Mfg. Co. has been incorporated at Sandusky, O., with a capital of \$1,000,000, taking over the business of the Sandusky Auto Parts & Motor Truck Co. The plans contemplate the manufacturing of tractors in addition to motor trucks.

CARRIAGE IN USE IS 200 YEARS OLD

In the village of Petersham, Mass., there is still in use a carriage said to have been built more than 200 years ago. Tradition says it was imported from France in the reign of Louis XIV. It is a sort of four-wheeled chaise with the body swung on leather thoroughbraces, after the fashion of the old Concord stage coaches. The top is very thin wood, covered with linen canvas and painted. The upholstering was made on a hand loom, from wool and linen. Tires, axles, hubs, bolts, and even the little tacks used to fasten the lining to the body are hand made. Linch pins hold the wheels in place.

ONE GOOD WAY TO REMOVE INSULATION

Removing insulation from electrical conductors made up of fine strands of wire is a matter of some difficulty, especially to the inexperienced "hand," if none of the strands are to be severed. It is very easily done, however, if the insulation is set on fire and allowed to burn off to the desired point. The wires will not be injured, and if there is any tendency toward brittleness the heating will remove it and leave the metal soft and pliable.

LOW BACK SEATS

The modern touring car is used more and more for long distance travel, and the comfort of driver and passengers alike demands the attention of designers. It has been predicted that a return to higher-backed seats is inevitable.

GET-TOGETHER MEETING

A meeting of implement dealers and others of southwest Missouri was held at the headquarters of the Business Men's League, in Carthage, and an organization was formed.

HAS BEEN ELECTRIFIED

Lou Sachs, for many years connected with the Columbus (O.) Buggy Co., has charge of the Electrical Auto Sales and Service Co.

BUICK ERECTING NEW PAINT PLANT

The Buick Motor Co., Flint, Mich., has commenced operations on the erection of a new building which is to be used as its enameling plant. It is expected that the structure, which will be 108 x 265 feet, will be completed by October 1.

Officers of the National Retail Hardware Association were elected as follows: President, E. E. Mitchell, Morrilton, Ark.; first vice-president, D. F. Barber, Boston; second vice-president, Charles T. Woodward, Carlinville, Ill.; treasurer, G. A. Pauly, St. Louis, Mo.; secretary, M. L. Corey, Argos, Ind. The next convention will be held in St. Paul.

H. F. Cartwright, after 17 years of service, part of the time as vice-president and sales manager for the Banner Buggy Co., St. Louis, Mo., has resigned for the purpose of engaging in the same line of work with the Regal Buggy Co.

The F. Ronstadt Co., Tucson, Ariz., has disposed of the machine shop and garage operated in connection with its business during the past five years. It is the company's intention to expand its operations in the sale of agricultural implements, wagons and related lines, and also to enlarge its blacksmith and wagon shop.

WANTS

Help and situation wanted advertisements, 1 cent a word; all other advertisements in this department, 5 cents a word; initials and figures count as words. Minimum price, 30 cents for each advertisement.

PATENTS

Patents—H. W. T. Jenner, patent attorney and mechanical expert, 606 F St., Washington, D. C. Established 1883. I make a free examination and report if a patent can be had and exactly what it will cost. Send for circular.

TUNGSTEN

In electric furnaces tungsten is used both in strips for winding coils and in tubes. Automobile manufacturers are using more and more of it for sparking points, and some are even adopting tungsten for all electrical contacts. In the form of gauze, tungsten is highly efficient for separating solids from acid baths, as the metal is insoluble in most common acids. Tungsten is slightly heavier than gold, and its use as an alloy for steel is well known, as also is its household usage as a filament for incandescent lamps.

INDEX TO ADVERTISERS

Baltimore Hub-Wheel and Mfg. Co.....	40
Cargill Company, The.....	40
Columbus Bolt Works.....	4th cover
Cumberland Hotel.....	2d cover
Dennis Hotel.....	2d cover
Dowler, Chas. L.....	40
Eccles, Richard, Co.....	2
Fairfield Rubber Co.....	3d cover
Gifford, John A., & Son.....	2
Jones & Co., Phineas.....	3d cover
Keystone Paint & Filler Co.....	3d cover
Lawson Co., F. H., The.....	3d cover
McKinnon Dash Co.....	4th cover
Masury, John W., & Son.....	2d cover
Meyer, John C., & Co.....	40
Miller Bros.	40
Mulholland Co., The.....	40
Murphy Varnish Co.....	4
National Spring & Wire Co.....	4th cover
Palm, Fechteler & Co.....	2
Payne Co., E. Scott.....	40
Porter, H. K.....	2
Schlegel Mfg. Co., The.....	40
Sheldon Axle Co.....	2
Sherwin-Williams Co., The.....	1
Skinner Bending Co., The J. M.....	40
Standard Oil Cloth Co.....	3
Technical School for Carriage Draftsmen and Mechanics..	40
Virginia and North Carolina Wheel Co.....	1
West Tire Setter Co.....	3d cover
White-Quehl Mfg. Co.....	40
Wilcox Mfg. Co., D.....	1
Willey Co., C. A.....	4th cover

BUSY BUYERS BRIEFS

Now is the time to place your orders for spring business on the
Meyer Threads and Spool Silks
 and Ready Wound Bobbins
 All sizes and colors for prompt delivery
John C. Meyer Thread Works
 Lowell, Mass.

Baltimore Hub-Wheel & Mfg. Company
 Manufacturers of
Wheels AUTO MOTOR CAR CARRIAGE WAGON
 Also **SPOKES and RIMS**
 Factory: Harford Ave. and B. & O. R. R.
 BALTIMORE MD.

CHARLES L. DOWLER
 CARRIAGE AND WAGON HARDWARE
 108 North Third St., Philadelphia, Pa.
CUSHION MANUFACTURER
 Pure Stearic Acid Candles. Wheel Stock. Snow
 Flake Axle Grease.

MULHOLLAND BUGGY SPRING
 Reduces weight of springs one-half.
 Made in one size only but will fit bodies of all widths.
 Write for further particulars and prices.
THE MULHOLLAND CO. DUNKIRK, N. Y.



White's Brazing Sleeves

For applying Rubber Tires
 Send for Samples.



WHITE-QUEHL MFG. CO.

431 E. Pearl St.
 CINCINNATI, OHIO

E. SCOTT PAYNE CO.
 Carriage and Automobile
HARDWARE
 Horse - Shoers' Supplies
 362-364 North Gay St., Baltimore, Md.

AUTOMOBILE Bodies AND CARRIAGES IN THE WHITE
 Estimates Furnished on Special Designs
MILLER BROTHERS
 Amesbury, Mass.

The Schlegel Mfg. Co.
 Rochester, N. Y.
 Manufacturers of Coach Lace
 and All Other Interior Trimmings

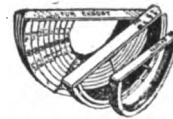

One of the oldest and largest Rim Plants in the world.

BENT RIMS

For Carriage and Wagon
 Wheels
 For Automobile Wheels

We make prompt deliveries in
HICKORY and OAK RIMS.
THE J. M. SKINNER BENDING CO.
 Toledo, Ohio

Carriage Mechanics

Desiring to improve their present
 Condition should attend the

TECHNICAL SCHOOL

FOR

Carriage Draftsmen and Mechanics

SUPPORTED BY THE

Carriage Builders' National Ass'n

The object of the School is to teach men to design vehicles and make working drawings, and to otherwise facilitate their work in the shop. Only those men employed in carriage or automobile building or their accessory trades are admitted to its privileges.

The classes are conducted in three divisions, viz.: Corresponding, Day, and Evening. The former is open during the entire year, while the day and evening classes are in session only from October 1 to April 1.

The tuition is moderate.

For prospectus and full particulars, write to the instructor,

ANDREW F. JOHNSON,
 20 West Forty-fourth St.,
 NEW YORK CITY

Cargill Service

has brought to the Cargill Company more Vehicle Catalogues than are made by any other printing house in America.

Cargill Quality is bringing The Best Automobile Catalogues to our plant for Complete production—watch for our imprint in the Season's best books.

THE CARGILL COMPANY

DESIGNERS
 ENGRAVERS



PRINTERS
 & BINDERS

Grand Rapids, Michigan



"Self-Propelled Vehicles"

Fifth Edition, Revised.

A practical treatise on the theory, construction, operation, care and management of all kinds of Automobiles.

By

JAMES E. HOMANS, A.M.

Contains 608 pages and upwards of 500 illustrations and diagrams, giving the essential details of construction and many important points on the successful operation of the various types of motor carriages driven by steam, gasoline and electricity.

This work is now the accepted standard, explaining the principles of construction and operation in a clear and helpful way. This book will be sent postpaid to any address in the United States, Mexico or Canada upon receipt of \$2.00.

Address

Trade News Publishing Co.

24 Murray Street, New York

Lawson's Sunken Panel, Twin Metal Buggy Seats

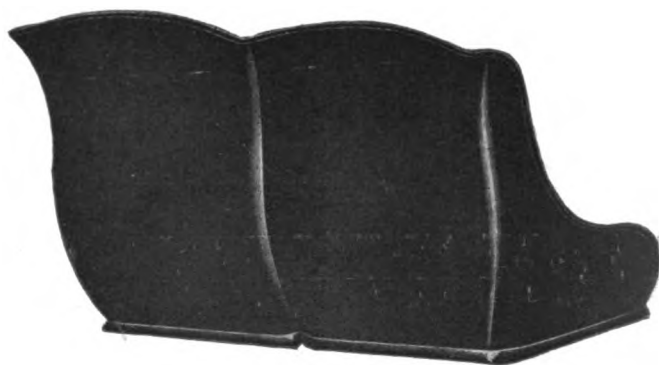

The Strongest—Neatest on the Market

Made in six sizes of 20 gauge automobile sheet metal. The Lawson seats are edged and bumped together by heavy presses.

We Use No Solder

Our seats were never known to come apart or rumble.

Write for Prices

The F. H. Lawson Co.

(Established 1816)

Cincinnati

Ohio

1855—Standard for 59 Years—1914

Jones Wheels

"Best on Earth"

The Name of Jones as Applied to Wheels Means the First, Last and All-the-Time Word in Wheels

"Kantsamore"

Buyers of vehicles should say, "Give me wheels made by

Phineas Jones & Co.

NEWARK

NEW JERSEY

U. S. A.

THE FAIRFIELD RUBBER COMPANY

Manufacturers of

**Carriage Cloth, Imitation Leather,
Automobile Cloths, etc.**

FAIRFIELD,

CONNECTICUT

The WEST Hydraulic Tire Setter WILL CUT DOWN EXPENSE

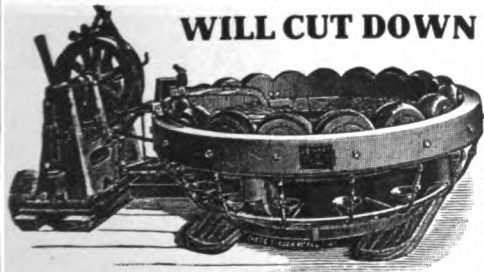

Tires set cold in one minute. This machine saves time—does the work better and quicker, does a way with burned streaks. Only necessary to measure one wheel in a lot. Does not char the rim, and thus make the tire loosen prematurely.

Saves resandpapering of wheels. This machine is now increasing the profits of many manufacturers. Send for catalog and read about it.

WEST TIRE SETTER CO.,

ROCHESTER, NEW YORK

KEYSTONE BLACK FILLER

MAKES A PERFECT

ROUGHSTUFF

For Automobile Bodies and Parts

It fills the pores of Metal and Wood perfectly. Sandpapers easily and produces a fine, smooth surface that DOES NOT CRACK, SCALE NOR PEEL.

POMEROY & FISCHER, New York
Selling Agents to Vehicle Trade

KEYSTONE PAINT AND FILLER CO., Muncy, Pa.

TROY, OHIO
CINCINNATI, OHIO

Your Vehicles will sell
against the
sharpest competition
if furnished with
McKINNON
WING
DASHES

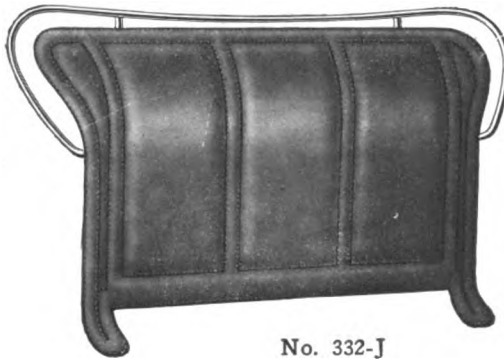

No. 332-J

ST. CATHARINES,
ONTARIO

A
WING
DASH
with Japanned Rail
that has a style and finish
to suit the
finest vehicle

McKINNON DASH CO. BUFFALO, N. Y.

"BLACK VELVET" CUSHION SPRINGS

Manufactured Only by the
NATIONAL SPRING AND WIRE COMPANY
ALBION, MICH. WINDSOR, ONT.

THE SPRING OF QUALITY.



SPRING or SOFT EDGE CUSHION FRAME
For Buggies or Other Vehicles. Built of the Highest
Grade of Steel Wire.

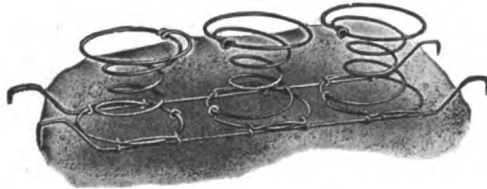

STRIP FOR WOOD OR BOX FRAME

WILLEY'S COLORS

The RECOGNIZED STANDARD



C. A. WILLEY CO.

COLOR GRINDERS

and Manufacturers of Specialties in

CARRIAGE, AUTOMOBILE AND CAR

PAINTS

COLORS, VARNISHES, ETC.

HUNTER'S POINT, NEW YORK CITY

Skewed Shaft Couplings

Regular or Oval Patterns
For High Arched Axles

Furnished in rights and lefts for any height of arch. Oval Axle
Clips $\frac{5}{8}$ or $\frac{3}{4}$ width to match Oval Couplings. Bolts, Clips,
Couplings. Carriage Hardware and Special Forgings

Catalogue "H" and Prices on Application

COLUMBUS BOLT WORKS, Columbus, O.

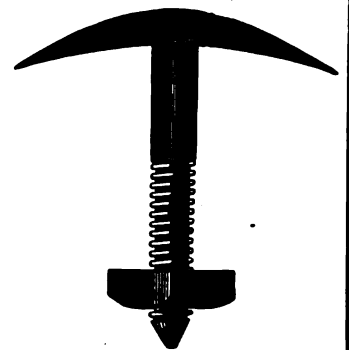
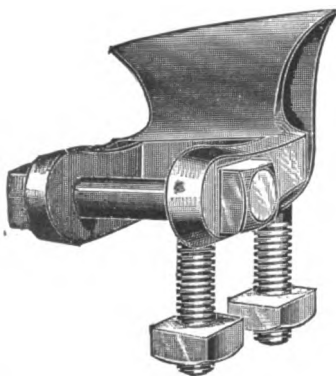

The Hub

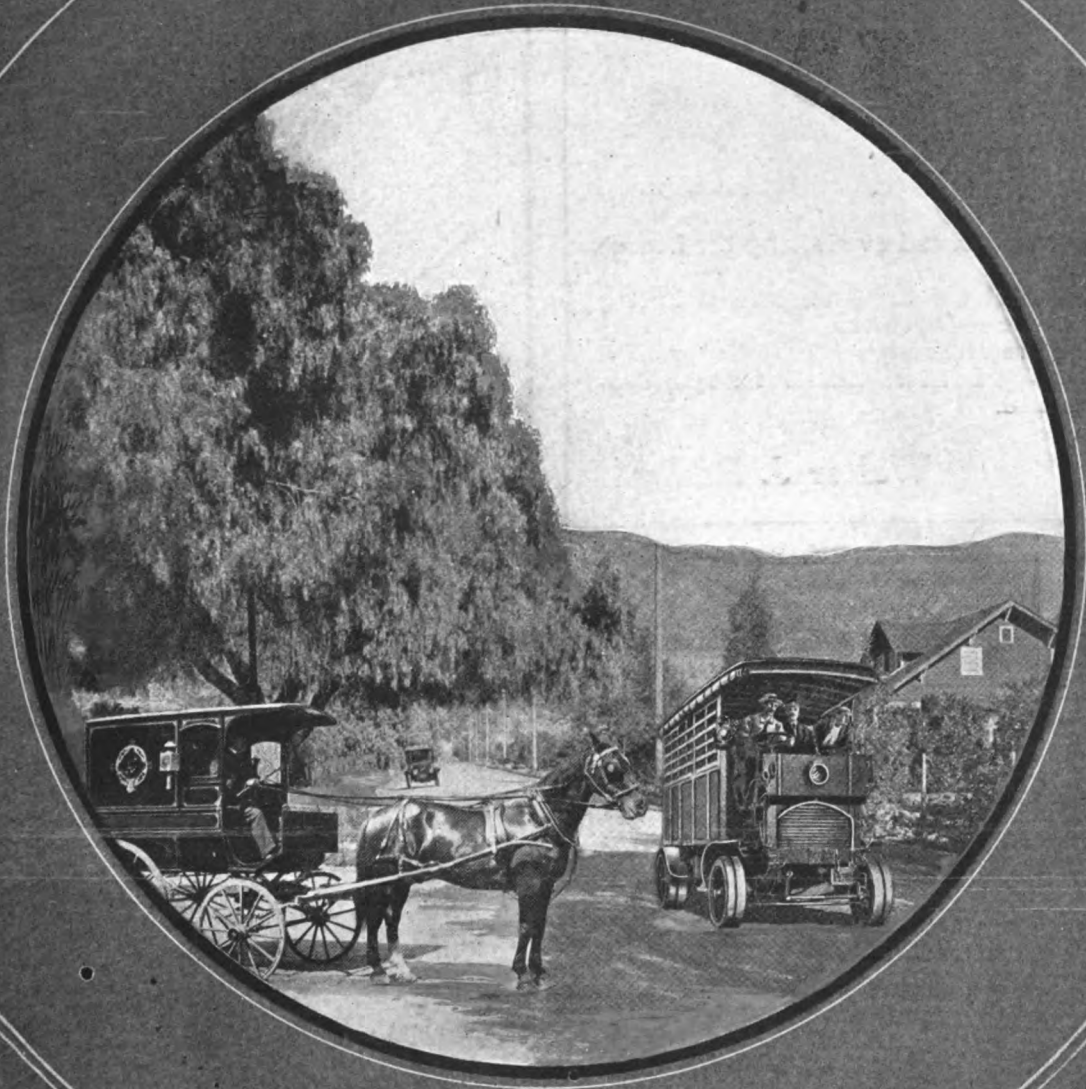

TRADE NEWS PUBLISHING COMPANY
24-26 MURRAY ST. NEW YORK.

HOTEL DENNIS

ATLANTIC CITY, N. J.

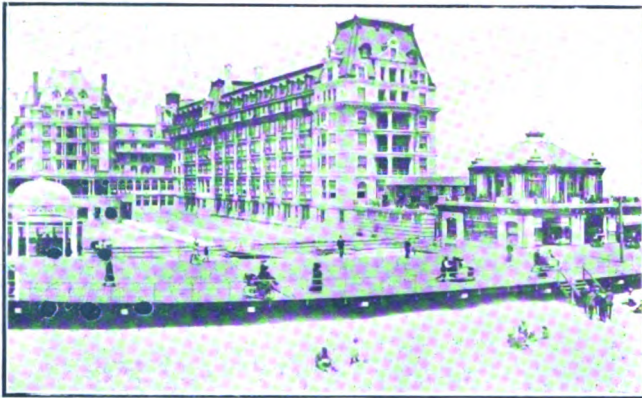

Directly facing the sea and overlooking the famous boardwalk.

Every room connected with private bath or having hot and cold running water.

Within one square of Young's Million Dollar Pier, where Carriage Builders' Exhibit for 1914 Convention is held.

Capacity 600.

Walter J. Buzby

HOTEL CUMBERLAND

NEW YORK

BROADWAY AT 54TH STREET

Near 50th St. Subway Station and 53d St. Elevated.

"Broadway" cars from Grand Central Depot pass the door, also 7th Avenue cars from Pennsylvania Station.

New and Fireproof

Best Hotel Accommodations in New York at Reasonable Rates.

\$2.50 with bath and up

European Plan

All Hardwood Floors and Oriental Rugs

Ten minutes' walk to 40 Theatres

Excellent Restaurant
Prices moderate

Send for Booklet



HARRY P. STIMSON, Formerly with Hotel Imperial

Only New York Hotel window-screened throughout

JOHN W. MASURY & SON

Originators of

Superfine Coach and Automobile Colors

Acknowledged the Standard for Fifty Years

AND MANUFACTURERS OF

Fine Carriage and Automobile Varnishes

New York,

Chicago,

Minneapolis,

Kansas City

SHERWIN-WILLIAMS
VEHICLE FINISHES

A PRODUCT FOR EVERY PURPOSE, PRODUCING DISTINCTIVE RESULTS

S-W METAL PRIMERS S-W BODY AND GEAR UNDERCOATINGS
S-W Q. D. COLORS S-W COLOR VARNISHES
S-W FINISHING VARNISHES

EFFICIENT IN QUALITY AND UNIFORMITY

THE SHERWIN-WILLIAMS Co.

CLEVELAND CHICAGO NEWARK MONTREAL LONDON, ENG.

WILCOX **F**^{FINE}_{INISHED}
ORGED

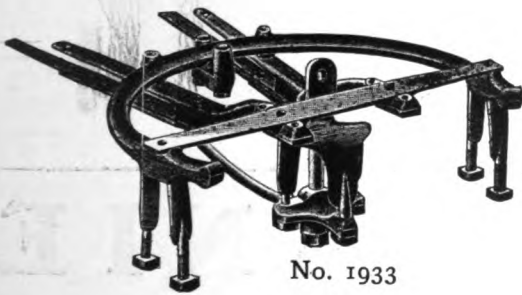

No. 1933

**Carriage Hardware
and Gear Irons**

Write us for Catalogue No. 11B

The D. Wilcox Mfg. Co.

**MECHANICSBURG,
CUMB. CO., PA.**

SHELDON AXLES AND SPRINGS

For Horse-Drawn and Power-Propelled
Vehicles of All Kinds

JUST ENOUGH BETTER THAN OTHERS TO BE NOTICEABLE

When you specify "Sheldon" you are not experimenting with experiments, but are getting Axles and Springs with years of manufacturing experience back of them—Axles and Springs that are selected for important work where conditions make reliability supremely important

SHELDON AXLE COMPANY - WILKES-BARRE, PA.

LARGEST AXLE AND SPRING FACTORY IN THE WORLD

PORTER'S BOLT CLIPPERS

"Easy" "New Easy" Allen-Randall



To Cut 5-16, 3-8, 1-2, 5-8, 3-4 Inch.

H. K. PORTER,

EVERETT, MASS.

Richard Eccles Co., Auburn, N.Y.

Manufacturers of

Forgings: Carriage, Wagon, Automobile' Special

Send for Catalogue No. 18;

Also Catalogue of Special Automobile Forgings



DECALCOMANIE

TRANSFERS FOR ALL PURPOSES

We Carry the Largest and Best Assorted Line of Stock DECALCOMANIE in the World.
Special Designs of All Kinds, Name Plates, Seat Risers, etc., etc.

DECALCOMANIE ADVERTISING SIGNS OF ALL KINDS

No Shop Complete Without Our Catalog. Write for one.

PALM, FECHTELER & CO., 67 Fifth Ave., New York

USE



MOTOR QUALITY
FOR UPHOLSTERING

REDUCE upholstery costs. Cut your covers from a Fabrikoid roll—use every inch of the material. Save the 25% waste of the irregular coated split.

MORE HASTE—LESS WASTE

in the upholstery shop where Motor Quality Fabrikoid replaces coated splits. The former has double the strength of splits—stands the pull and strain without splitting. Your upholsterers can do more, and the vehicle becomes more attractive and salable with Motor Quality Fabrikoid.

Motor Quality Fabrikoid is guaranteed superior to any other artificial leather made—including coated splits.

STATE INTENDED USE
AND WRITE FOR SAMPLES

DEPARTMENT 269
DU PONT FABRIKOID CO.
WILMINGTON, DELAWARE
TORONTO, ONTARIO

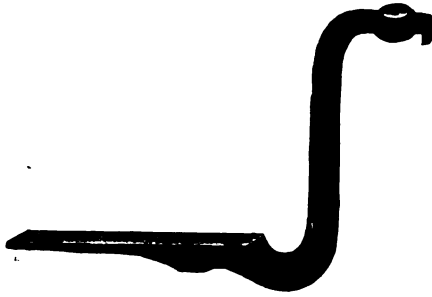

**BODY
LOOPS**

**ALL
SIZES
ALL
STYLES**

MANUFACTURED BY
The Keystone Forging Co.
Northumberland, Pa.
WRITE FOR PRICES

Established 1886

**Correspondence School of Carriage and Motor
Carriage Drafting**

A thorough, practical tuition is given through this correspondence school. The theory and practice of construction, bookkeeping, perspective. Many men now hold good positions through taking the courses of instruction.

Principal, **THOS. MATTISON,**
Hillside Avenue, Bitterne Park,
Southampton, England

Author of "The Coach Body Makers' Guide," \$3.00; a practical treatise on "The Suspension of Carriages," "Bookkeeping," and other carriage building works.

WHAT IT IS

The American Harness and Saddlery Directory The 1914 Edition

An extra painstaking revision of the names (and other information as below) constituting the Retail Harness Trade, has been completed for this year's issue of the Directory, and we think the work is so important and worthy that the

1914 Price Is \$5 Per Copy

and it is very moderate for what is offered in a work that is

Indispensable for Reference

for copying of addresses, and for all purposes usual in a directory.

Just a Sketch of Its Contents

The list of the **WHOLESALE** and **JOBGING TRADE** is so arranged as to make it convenient to separate the association members from those not so recognized.

The **RETAIL HARNESS MAKERS** of the United States and Canada comprise the principal part of the Directory, arranged by State, Town and County, and in the large cities, the street and number is given. Those rating (approximately) over \$1,000 are marked.

A list of **HARNESS DEALERS** as distinguished from retail harness manufacturers, is also given. The value of this list to those who solicit the vehicle, implement, hardware and department stores will be readily appreciated.

A list is also published of Export Commission Merchants, giving the class of merchandise they handle.

PUBLISHED BY

THE TRADE NEWS PUBLISHING COMPANY

PUBLISHERS OF "HARNESS"

24-26 MURRAY ST., NEW YORK

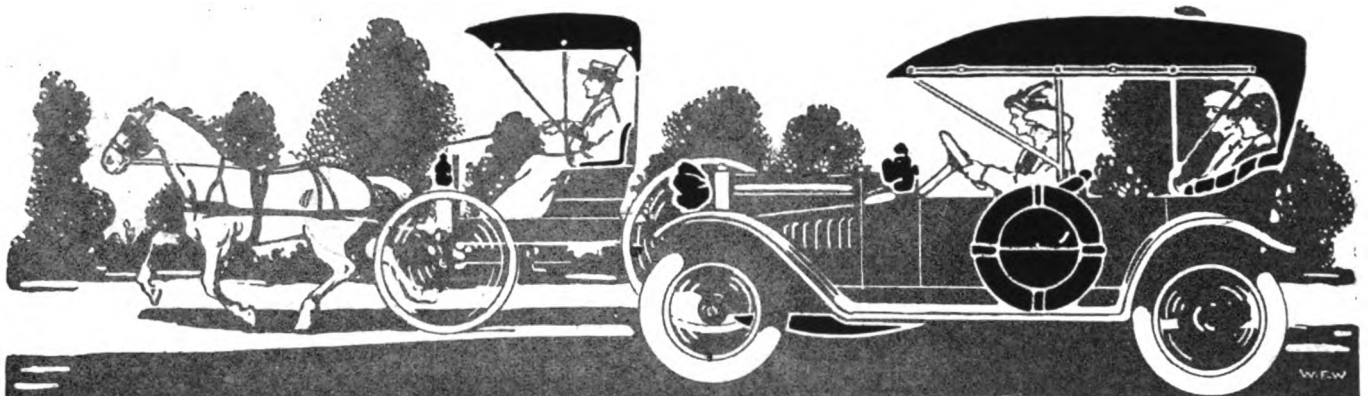

Learn More About The Leading Leather Substitute

Every carriage and automobile manufacturer—every manufacturer of carriage and auto accessories, storm curtains, aprons, lamp covers, tire cases, trunks, etc., should get and examine samples of

MERITAS

LEATHER CLOTH

Only by seeing the goods—by testing them—by noting the handsome, durable, non-cracking finish and the fine line of colors can you appreciate the high quality we have attained in the manufacture of a serviceable leather substitute.

There are styles, colors and finishes in MERITAS LEATHER CLOTH suitable for every carriage and auto trimming and upholstery purpose.

It can be had in muslin, duck and drill; dull or glazed; smooth or grained; in black and colors.

Sample book on request—write now and know more about the leading leather substitute.

Write
for
sample
book of
MERITAS
LEATHER CLOTH
NOW

Standard Oil Cloth Co.

320 Broadway, New York

The Hub

Copyright, 1914, by the Trade News Publishing Co., of New York

Entered in the New York Post Office as Second-class Matter

Vol. LVI

JULY, 1914

No. 4

THE TRADE NEWS PUBLISHING CO. OF N. Y. Publishers of THE HUB

J. H. WRIGHT, *President* G. A. TANNER, *Secretary and Treasurer*
24-26 MURRAY STREET, NEW YORK

Other Publications of Trade News Publishing Co.:

HARNESS (monthly).....per year, \$1.00
AMERICAN HARNESS AND SADDLERY
DIRECTORY (annual).....per copy, \$5.00

THE HUB is published monthly in the interest of employers and workmen connected with the manufacture of Carriages, Wagons, Sleighs, Automobiles and the Accessory trades, and also in the interest of Dealers.

Subscription price for the United States, Mexico, Cuba, Porto Rico, Guam the Philippines, and the Hawaiian Islands, \$2.00, Canada, \$2.50, payable strictly in advance. Single copies, 25 cents. Remittances at risk of subscriber, unless by registered letter, or by draft, check, express or post-office order, payable to the order of THE TRADE NEWS PUBLISHING CO.

For advertising rates, apply to the Publishers. Advertisements must be acceptable in every respect. Copy for new advertisements must be received by the 25th of the preceding month, and requests to alter or discontinue advertisements must be received before the 12th day of the preceding month to insure attention in the following number. All communications must be accompanied by the full name and address of writer.

FOREIGN REPRESENTATIVES:

FRANCE—L. Dupont, publisher of *Le Guide des Carrossiers*, 78 Rue Boissiere, Paris. Subscription price, 15 francs, postpaid.

GERMANY—Gustave Miesen, Bohn a Rh. Subscription price, 12 marks, postpaid.

ENGLAND—Thomas Mattison, "Floriana," Hillside avenue, Bitterne Park Southampton. Subscription price, 12 shillings, postpaid.

Entered in the New York Post Office as Second-class Matter

The Text—The Sermon

We are using as text an editorial note that was published in the New York Times, because it ought to interest everyone who distributes cash for advertising. We do this as much, unfortunately, for the gratification of a petty "I told you so" feeling, as for a more ethical reason. But what matters personal impulse if truth is established? No time will be lost by anyone who reads the editorial and its reply to the end:

The Text

Attention has been called by an esteemed but somewhat incautious neighbor to the fact that there has been in the past year a slight decrease of automobile advertising in The Times. Yet explanation of the phenomenon might be more interesting to the general public than is the phenomenon itself, and as to give it will present for consideration a very pretty problem under the postal laws we are moved to do so.

Certain advertisers, including some makers and dealers in automobiles, think that when they buy space in the advertising columns of a newspaper they also buy, or at least can fairly expect to get, in addition, the insertion as news of such bits of information as to their achievements and operations as they obligingly bring to that paper's attention. One should not, and we do not, blame the advertisers for wanting to obtain as much

as they can for their money, or criticise them for spending it where they please. We may have an opinion as to the sort of judgment they show in withholding their patronage from papers that accept or reject matter for the news columns on other grounds than that of getting or losing an advertisement. To express that opinion, however, is not necessary, but there is point—and right here the reader of these remarks will begin to get light on the use above of the word "incautious"—in asking this question: When the getting of an advertisement depends on giving some additional space in the news columns, and it has been accepted on those terms, explicit or implicit, is not what appears as news a real and essential part of the advertisement and, therefore, illegal unless so marked?

This inquiry deserves an answer, and if it does not get one from the able mathematician who has been measuring the automobile advertisements in The Times, perhaps some official in the Post Office Department will devote a part of his powerful intellect to the satisfying of our keen and surely legitimate curiosity on the subject. Whether he does or not, the dear public will now know exactly why some papers get some automobile advertisements and why some others do not. Also, why certain facts are not explained by those who promulgate them.

The Sermon

Your editorial in "Topics of the Times" this morning, in which you exposed the advertising methods of some of the automobile companies and the newspapers that accept copy with the mutual understanding that "free reading notices" will be given in addition to the regular advertising space, has only scratched the surface of an evil that has been growing by leaps and bounds ever since the motor car proved to be so marvelous a commercial success. There is doubtless more money spent for advertising automobiles than for any other single manufactured product, and this has led some of the "weaker sisters" among the newspapers and magazines to offer, by inference, at least, in the form of additional space what they could not offer in quantity or character of circulation.

So extensive had this practice become at one time that I know of several "agencies" formed solely for the preparation and placing of these automobile reading notices. The contract of these agencies with a client called for the publication of the name of his company in the editorial column of a specified number of newspapers and magazines. This, of course, was space for which the agent paid nothing, except, possibly, the promise of "full-page copy as soon as — make their appropriation."

Possibly the biggest farce in this connection is a so-called column or page of "Motor Notes" appearing in many of our daily papers, and to which the name of the advertising solicitor having charge of the automobile accounts is appended as the "author." I have occasion to see regularly the publicity notes issued by the leading motor car concerns, and in the majority of instances such of those as come from present or prospective advertisers are reprinted, word for word, in the "signed" column of notes. I know that now many automobile buyers or owners have come to look for the appearance of large advertising copy soon after the continued mention of some particular automobile concern, and, as a rule, the observing reader can find a close relation between the amount of space bought during the year by a cer-

tain advertiser and the number of times that his name appears in the "automobile column."

And this practice is even extended to some of our so-called high grade periodicals in their effort to interest the automobile advertisers in their publications as profitable media. Witness some of these that have issued "automobile numbers," in which a certain page of some automobile company's advertisement is followed by an editorial on some phase of motoring, signed by the writer as President or General Manager of the company whose advertisement faced the editorial article. Measured by the publicity obtained by such a procedure, the advertisers taking advantage of this offer are given two pages of advertising for the price of one. This practice not only bears out your contention in regard to unmarked advertisements, but amounts to a cut in advertising rates.

But does this pay? I believe the majority of the reliable motor car concerns are beginning to realize that it does not; and if the advertiser is not benefitted, the publication itself certainly will not be.

The sincerity of purpose of both publication and advertiser is doubted, and, while the copy and publicity material may be read, the message of neither is as convincing to the prospective buyer as is that which he sees in a newspaper or magazine concerning which he knows that the right hand of the publication knows not what advertising contract the left hand holds. Through several years' experience with both classes of publications, I am convinced that the one that best holds the confidence of its readers is the one that will win out above that which carries a greater amount of advertising obtained directly or indirectly through the offer of additional space in the editorial or news columns.

By this I do not mean that all publicity matter furnished by the automobile companies should not be published, for much of this may have a distinct news interest; but I do believe that such media as give the preference in the publication of this news to their advertisers, or which publish an item merely for the sake of introducing a trade name into the news columns, are as unworthy of patronage as are the advertisers who thus intend to take advantage of a once-gullible automobile-buying public. I have in mind the case of a one-time famous automobile company that had made a standing offer to the reporters on certain papers of \$1 for each time the company's car was mentioned in a news item—breakdowns barred, of course. This automobile company has now been out of business for several years.

And it would seem that some carriage trade journals are drifting dangerously near the brink of unmarked advertisements.

Motor Abuse

The death toll from automobile accidents is alarming. The serious part of it is that practically every accident that results in the increasing loss of life comes under the avoidable class. Literally speaking, therefore, they are not accidents. A movement must be started for a safe and sane conduct before criminal carelessness meets its just retaliation.

The dependable motor car, when driven with care and competence, is one of the safest means of transportation that human ingenuity has devised, but unfortunately a good many of these machines are in the hands of drivers who, though competent, are not careful, and by their recklessness habitually endanger the lives of others as well as their own.

Every community has its one or many terrors of the highway whether it be New York City, Auburn, Ind.,

or Podunk Xroads, who would have lost his license long ago if our law makers did their duty in defiance of "the trade," and made amateur chauffeurs amenable to the qualifying and controlling regulations to which the professionals are subjected. Little, if any, less dangerous than men of that sort are the automobilists who are careful without being competent, and then comes a group larger than either of these two, consisting of those whose only qualification for driving a motor car is that they had or could raise the money to pay for one—or somebody else did it for them. In this third division, neither careful nor competent, comes the steadily increasing number of boys and girls not far along in their teens who daily are to be seen flying along every road in cars supplied by injudicious parents.

Whoever reads the list of automobile disasters with attention must have been struck by the frequency with which the names of doctors figure in them. Perhaps that is due only to the fact that doctors are many, and that almost every one of them, nowadays, has a car as a necessary part of his professional equipment. Doctors are often in a great hurry, too, and that tends toward the production of assorted collisions about as much as does the "scorching" that is without the doctor's good excuse.

It is well to remember, while talking about automobiles, that thousands and thousands of people run these machines year after year without having a single accident. Naturally their names do not get into the papers, since it is not news when nothing happens, but they are living proofs that the automobile, in itself, is safe.

We read of very few accidents from reckless driving of horse-drawn vehicles, notwithstanding the driver of a horse, no matter how skillful, is constantly more or less at the mercy of an animal more subject than almost any other to mad panics and foolish frights.

Fortunately we have S. P. C. As. Why not a S. P. C. Motors?

How Can We Have Prosperity?

The writer made the remark at one time that if these United States were not so wonderfully rich in resources the millions of dollars that has been contributed to automobile junk piles and scrap heaps would have driven the country on the financial rocks. And we are not so sure that this factor has not added a percentage to the whole that makes for periods of stringency. Granting every argument in favor of automobiles, the deterioration is a big unrepresentative item vs. the production of wealth. Do automobiles produce prosperity, or the moving picture industry, or the liquor trade, or many others which might be put in the list? The question is whether industries of this sort, absorbing hundreds of millions in production, and requiring the expenditure of more millions to make them profitable, are of a kind which keep the country going ahead, producing prosperity instead of depression. There can be no doubt that autos are a splendid tribute to American mechanical ingenuity, and commercial initiative and organization, but are they pro-

ducers of prosperity? The fact that it is necessary to ask the question answers it. When Americans are thinking so much of their pleasures they are not giving as much sober thought as they ought to the basic causes of the cost of high living. Always the revolution of economic cycles causes earners of money to debate how they may get it rather than how they may spend it. When that time comes improving times lie ahead. When the question is how money may be spent rather than how it may be earned, deteriorating times may be expected. When a hundred million of us approach a single mind about this they will give a quick decision to the question, How can we have prosperity?

The Automobile Virtues and Vices

The railroads, good and bad, and we are not referring to the road beds, have sought every excuse upon which to lay a complaint against the people who have grown wise and refuse to invest. The "dear peepul" have discovered that the moguls who "run" railroads don't seem to own much of the stock, but are long on "proxies." The latest, and here is where the poor and much abused automobile comes in, is that concerning the responsibility of automobiles for the diversion of capital from the railroads, and therefore to that extent for the depression in the railway industry. It is a pretty question in economics, and may arouse the interest of those who otherwise would not pursue the question. The point may be illustrated by the case of the old Hartford automobile factory which has just been converted into a factory for machine tools. Assuming the amounts involved to be the same, which use of capital is more to the interest of the country?

There is no question that the country has no use for an industry which cannot sustain itself. The tariff was fought on that issue, and the country has decided that it wants no pap-fed industries, for they come too high. The question is whether the country would be better off if the \$250,000,000 of automobile output last year were a product of equal value of industrial machinery. That depends upon the product of the product, not upon the amount of wages spent in the production. Automobiles are increasingly used in industry, and to that extent they stand on the same footing as machine tools. They also produce much economic wealth in the form of health of human machines, and to that extent the product has actual value. Automobiles also give much honest and simple pleasure, within the means of those using them. In none of these aspects is there room for criticism of the automobile industry. There is, however, a remnant of use which distinguishes automobiles from machines used altogether in industry, and therefore open to no such criticism as applies to some uncertain part of capital sunk in automobiles. Railways make losses only for their owners; all others profit by them, whatever their rates. Tools may be used at a loss to their owners, but never by intention. Tools of industry always are used for reproduction of something meant to be useful. Automobiles produce no automobiles. Automobile machinery may be conceived of as producing clothes, or shoes, as

grinding grains, or producing tools to make other tools. Automobiles produce wages for chauffeurs, but that is nothing in comparison with the wages paid to industrial machine drivers. It is dazzling to imagine an output of a quarter of a billion of capital annually of machinery used to cheapen processes of industry, or products of other machinery.

This cannot be claimed for the automobile, no, but there are other trades equally as bad, and we say bad advisedly.

The Point of View

H. B. Endicott is the biggest shoe maker on earth. A customer asked his view on the situation, and Mr. Endicott wrote him a letter. We publish a part of it as a contrast to the outgivings of the Joy-rider, who let off last month wherever he could find an audience. He had a seat in our aerdrome, because we take interest in all out of the ordinary. Mr. Endicott is in that class, too, we think:

Critics, it always seems to me, have an easy job. I attended a baseball game yesterday, and sat on the bleachers, and it was surprising how much more about the game the men around me knew than the umpire or the players.

Such being the base in the baseball business, it is not surprising to find so many men that think they can improve upon the job of the President.

I am not writing you this letter to defend the President. I question whether any defense from me would do any good, but I do believe that a lot of opportunities are wasted by the country as a whole, spending too much time criticizing the present administration.

There can be no doubt but what the railroads have had a very hard time. They may have formed, in times past, extravagant habits in the way of management which, of course, are hard to change.

My belief is, that if the American people, as a whole, whether they are for or against the administration, whether they are free traders or protectionists, whether they are trust presidents or day laborers, will just stop wasting their time talking about the hard things that have come to us and realize the facts as they are, we will see the largest business that this country has ever had.

I don't mean by the above statements that I think we are going to have an easy time doing business in this country. On the contrary, I think competition will be keener than ever, but the business houses built on economical lines will be in shape to get this competition. In my judgment, the old-fashioned extravagantly managed concerns will have to fall by the way-side.

General Vehicle Tax

There is a movement, put in motion by automobile makers, to have a universal tax levied on vehicles that use roads. All sorts are to come under the provision.

This seems a fair proposition, and would do much towards the increase of funds needed for better roadways the country over.

The C. B. N. A. started the movement for "good roads" years ago, so it is fair to suppose that it would join forces for such a purpose.

Roughly speaking, highway funds aggregating \$130,000,000 a year could be raised by all the states under

such a plan. The 1,385,000 motor cars, at fees of from \$10 to \$25, would produce about \$19,000,000; the estimated 14,600,000 horse-drawn vehicles at \$5 to \$20 each would mean \$108,000,000 more, while the 2,800,000 motorcycles and bicycles now in use, paying license fees of from \$1 to \$3, would add \$3,400,000 more. The total would almost equal the aggregate of funds provided by all the counties, districts, and townships in the United States for this year, and would be more than three times the available state funds for road work.

Think of It

Only a few years ago it would have been thought absurd that an institution of learning of any class, but especially of the standing of the New York University should announce a course of study on "advertising," and arrange for instructors and lecturers such as C. F. Bacon, B.A., LL.D.; J. W. Jenks, Ph.D., LL.D., and so on to the extent of fifteen men prominent as thinkers and instructors.

This marks the stride that has been taken in the enlarged view of this subject which has been found to be full of the greatest practical importance.

This education is being passed on to the business man to his own benefit. He has a better understanding of what his object is when he makes an outlay for publicity. The vast sums yearly expended are now ably handled, compared to the almost as large sums that used to be squandered on a hit and miss plan.

The solicitor who cajoles, "jollies," begs, or resorts to any meretricious devices to part a manufacturer from his money is very nearly extinct. The man of today has a business proposition, backed with facts and figures to offer for the consideration of another business man with whom he wants to transact business.

Think of It!

The Drug Forming Habit

We are listening to so much condemnation of "drug forming habits" these days.

It seems to us the habits might be made useful. If some drug could be compounded that would form habits of common sense in "publicity managers," think of the money they would save for their indulgent bosses. Consider what a vast amount of "stuff" is "canned" in journal offices that has cost much money to prepare and mail, just on the chance of a free editorial notice. Invested in paid-for publicity in the advertising pages of a journal it would have much more "drawing" power than the editorial waste basket. There can't be a difference of opinion about that. The boss is to be pitied for his want of knowledge as to the final disposition of the matter prepared by the clever man who thinks he has a clever way of putting free advertising across. If there is another turn of the screw in general business, perhaps some of the publicity promoters will be looking for jobs in place of holding down snaps.

Different Trade—Same Tricks

When the buoyant, if not flamboyant, autocar was a monarch of all it surveyed, it was the habit of the purchaser to patiently await his turn to be served.

As time passes and cars increase, the customer is sought in the highways in order that the privilege of serving him may be acquired.

Still further along, the customer having been well loaded with cars, it becomes necessary, if a new car is to be worked off on him, to trade in his old car in part payment. That is the selling condition of the automobile trade today.

It has become quite like the trade in high grade vehicles, when they dominated the field.

It gives the buyer of second-hand cars a fine chance to get a car at about its real worth as a new car.

A Little Learning, etc.

"If the folly ended with his miserable self our grief would be short; but the business liar commits hari-kari, maiming and killing innocent competition by destroying the basis of all business," etc.

Wonder if Mr. Shuman knows as little about his subject as he does about hari-kari, its methods and strictly individual consequences?

Something Important

Sidney (Ohio) Mfg. Co. is doing some stunts in the manipulation of metal for bodies that may become epoch-making in a way. The machinery is in process of patenting, but until the patents are complete it would be obviously not the thing to enter into any description. We understand for one thing that the metal is rolled into body shape in place of being beaten into form.

True Politeness

The Briton is always so very polite in his way of putting the point of view. In place of brutally blurting, as we do, "installment plan, dollar down and dollar a week," when we want to unload unwanted motor cars, he says, "deferred payments may be arranged." Isn't it nice!

Room For One, With or Without

Of all the absurd contraptions, the blue ribbon outfit is a motorcycle with a bunch of family party clinging to it like some seaweed to a rock on the shore. What strange tastes mortals exhibit.

NEW TRUSTEES NAMED

Dan R. Hanna, of Cleveland, and W. R. Timken, of Canton, were elected trustees of the McKinley Memorial Association to fill vacancies caused by the deaths of General Henry Duffield, of Detroit, and Thomas Dolan, of Philadelphia.

RECENT WHOLESALE STYLE EXPRESSION

(See illustrations)

The Brown Carriage Co. is a Cincinnati outfit that thinks before it builds buggies, then puts these "thinks" into concrete expression; in other words, onto wheels, so it will roll around and make others think.

The concern is rather particular and fault finding as to the wheel stock. It seems to have an idea that wheels should be somewhat like a government institution—that is, permanent. And in this they have found their reward, we are told.

We find that in the small items that show concentration on detail for a purpose, like indestructibility of body (within reason) toughness of timber that has to stand stress, and such like, a little more money is wasted (!) on the work, and yet another dealer "saved," scripturally speaking.

We are showing this month on one page the obsession of the "auto" seat, and the way the Brown people treat it. We illustrate it "coming and going," so the full effect is had.

The body treatment in this case is trade-catching to a degree, and an awkward type of seat is made to look much better than it is. However it is the spooner's delight, the heaven of the one-hand driver, and sells, which is the merit of chief excellence. Every fellow puts in an auto seat, and the Brown people seem to have done so most happily.

On the following page we show two jobs as alike as two peas in a pod. We do this to show the wasteful duplication of "style" that is so expansive, and amounts to so little. It is a leather quarter top and plain leather top when one would answer all practical as well as ornamental purposes.

These two examples are made for southern trade, and an inspection of them will give another reason why the south is in love with the buggy, as a standby vehicle. It is astounding what good value is rendered for the price asked.

C. B. N. A. CONVENTION PRACTICAL INFORMATION—READ AND REMEMBER

During the month of September practically all of the railroads provide a special rate on tourist or excursion tickets to Atlantic City, covering nearly every section of the country. The agents of these roads have

Reduced Rate Tickets

on sale or will procure them when applied for. For your convention trip you can buy these tickets as early as September 1, and from then on all through the month up to the dates set for the convention. The tickets are

Good for 30 Days from the date of purchase

The conditions under which these tickets are sold are very favorable for convention visitors, not only to attend the convention and exhibition, but also to spend as many days as one likes enjoying the delights of the most renowned seaside resort in the world. Besides you get the concession from regular rates at the most favorable time of the year to visit Atlantic City.

Annual Meetings and Exhibition

As to the convention itself, the addresses and discussions will be of such a nature that no member of the association can afford to miss them. At the exhibition there will be shown the latest and best that the manufacturers of vehicle supplies can furnish for the necessities of your business.

The entertainments being arranged to accompany this year's meetings will be above the average of such affairs, and the annual reception and banquet, at the Marlborough-Blenheim, will be up to usual high standard.

Best of all, at the convention room, in the exhibition hall and at the hotels, you will meet your brother craftsmen in friendly, social intercourse. You will enjoy seeing them and hearing them talk, and you will get a great deal of information regarding the vehicle business in all parts of the country.

If you want to be instructed and amused; if you want to enjoy the sight of the old ocean and the touch of health-giving sea breezes; if you want to meet old friends and make new ones; if you are interested in the newest things that concern your business—you can get all of these, and more, by coming to the Forty-second Annual Convention and Exhibition of the C. B. N. A., at Atlantic City next September. Decide now and make your arrangements early. You mustn't miss it.

Mt. Vernon, N. Y.

HENRY C. McLEAR, Secretary.

EXHIBITORS AT THE C. B. N. A. CONVENTION

The following accessory firms (so far) signed for space at the exhibition to be held on the Million Dollar Pier, Atlantic City, in connection with the forty-second annual convention of the Carriage Builders' National Association. The convention will be held from September 28 to October 2:

Bradley, C. C. & Son, Syracuse, N. Y.
 Backstay Machine & Leather Co., Union City, Ind.
 Blacksmith and Wheelwright, New York.
 Carr Co., F. S., Boston, Mass.
 Carter Co., Geo. R., Connerville, Ind.
 Cately & Ettlign, Cortland, N. Y.
 Chase & Co., L. C., Boston, Mass.
 Cleveland Hardware Co., Cleveland, O.
 Cortland Carriage Goods Co., Cortland, N. Y.
 Cortland Forging Co., Cortland, N. Y.
 Cowles & Co., C., New Haven, Conn.
 Ditzler Color Co., Detroit, Mich.
 Eberhard Mfg. Co., Cleveland, O.
 Fabrikoid Works, Wilmington, Del.
 Fairfield Rubber Co., Fairfield, Conn.
 Fernald Mfg. Co., North East, Pa.
 Firestone Tire and Rubber Co., The, Akron, O.
 Gerhab, Jacob, Philadelphia.
 Goodyear Tire and Rubber Co., The, Akron, O.
 The Hub, New York City.
 Illinois Iron & Bolt Co., Carpentersville, Ill.
 Liggett Spring & Axle Co., Pittsburgh, Pa.
 Metal Stamping Co., Long Island City, N. Y.
 Monarch Carriage Goods Co., Cincinnati, O.
 National Carbon Co., Cleveland, O.
 National Malleable Castings Co., Cleveland, O.
 Peters & Herron Dash Co., Columbus, O.
 Rhodes & Co., James H., Chicago, Ill.
 Rielly & Son, P., Newark, N. J.
 Rodriguez, R. E., New York.
 Rogers, E. F. & Co., Philadelphia.
 Rose Mfg. Co., Philadelphia.
 Sheldon Axle Co., Wilkes-Barre, Pa.
 Smith & Co., Edward, New York.
 Standard Varnish Works, Chicago.
 Valentine & Co., New York.
 Ware Bros. Co., Philadelphia, trade journal.
 Western Spring & Axle Co., Cincinnati, O.
 Wilcox Mfg. Co., D. Mechanicsburg, Pa.
 Willey Co., C. A., Hunter's Point, N. Y.
 Crandal, Stone & Co., Binghamton, N. Y.
 Woll, P., & Sons Mfg. Co., Philadelphia, Pa.
 Raser Tanning Co., Ashtabula, O.

DANIEL T. WILSON

Mr. D. T. Wilson, so long the owner of Flandrau & Co., and so very widely known and popular, too, wherever carriage men do meet, has identified his energy and capabilities with Brewster & Co., Long Island City, N. Y.

We regard this step as a wonderful conjunction for both the parties in interest, and we tender sincerest congratulations.

Doing It Up Brown—Wholesale Trade Fashions

BACK END EFFECT OF AUTO SEAT
(See description)



AUTO SEAT IMITATION CUT-UNDER BUGGY
(See description)

Demonstrating Unnecessary Repetition

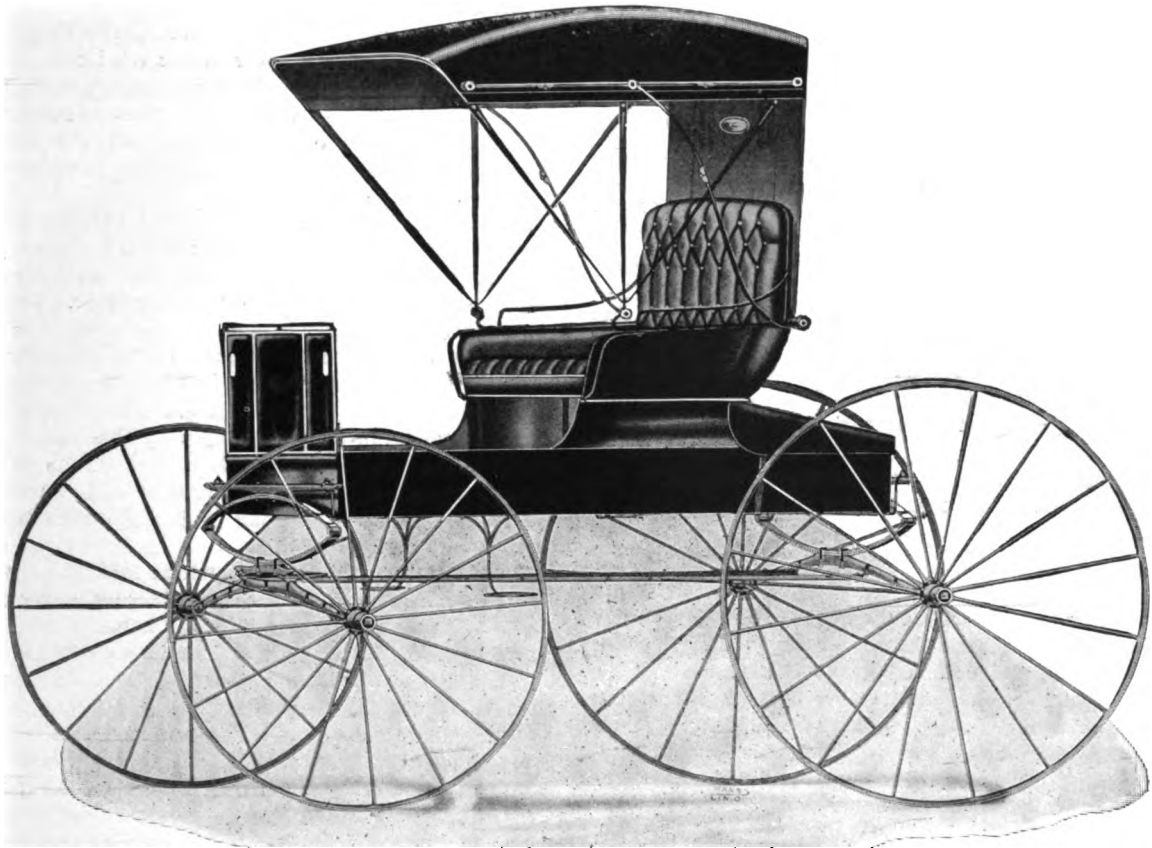

LEATHER QUARTER TOP BUGGY



LEATHER TOP BUGGY

PROSPEROUS CONDITIONS OF FRENCH AUTOMOBILE TRADE

The year 1913 was one of great prosperity for the trade. The production and home demand increased, while the foreign trade reached record figures. The value of the exports of pleasure motor cars in 1913 was \$41,978,850 as compared with \$39,970,879 in 1912. More noticeable was the increase in the foreign shipment of French motor cars for industrial purposes, the value of the shipments in 1913 being \$1,914,753 against \$944,735 during the previous year.

The use of foreign automobiles is being more and more felt in the French market, especially as regards the motor cars made in England and in the United States. The imports of passenger motor cars increased from \$2,481,980 in 1912 to \$3,617,399 in 1913. No official statistics are available which would indicate the countries from which the automobiles were shipped, but from information obtained from unofficial sources, there were 627 American motor cars imported into France in 1913 against 264 cars in 1912. The invasion of the American motor car has caused much comment in the French press and predictions have been made that the total imports of motor cars from the United States will greatly increase during the present year.

NATIONAL FOREIGN TRADE CONVENTION

The National Foreign Trade Council, consisting of 30 men of national prominence, representative of the industrial, commercial, transportation and financial interests organized in accordance with the mandate of the National Foreign Trade convention, has begun a systematic and aggressive campaign for extension of American foreign trade. Secretary Redfield said: "If there is one thing European manufacturers dread as regards the future of their own business it is that America shall awake to her privilege and her power in foreign trade."

The National Foreign Trade Council was created to do the awakening. The movement sprang from a realization by industrial leaders that prosperity largely depends upon increased export trade now that the new tariff has precipitated American manufacturers into world competition.

HUBS GO CHEAPER IN MICHIGAN

The Michigan Interstate Commerce Commission has ruled that motor car hubs are subject to fourth-class rating instead of second and third-class rating which the carriers have applied in the past. This means a considerable reduction in transportation charges, as fourth-class rates, for instance, from Detroit to Lansing are now 11 cents for less than carload lots as against 21 cents second and third-class rating. While in carload lots the new rate is 8½ cents instead of 17 cents. No decision has been rendered concerning wheels and brake-drums.

FIRESTONE FOREMEN MOTOR 150 MILES FOR A FROLIC AT THE FIRESTONE HOMESTEAD

July 11, a procession of 40 automobiles left Akron, headed for the Old Firestone Homestead, 80 miles away.

The party was composed exclusively of superintendents and foremen of the Firestone tire and rim factories and officials of the company, numbering 170. It was a Firestone factory family affair, with Mr. H. S. Firestone as host.

After dinner Mr. Firestone told "the boys" what he thought of them: then for the ball diamond, the fishing hole, the quoit games, the inspection, to say nothing of the testing of the horns and all the joys that a perfect farm home and a thoughtful host can provide.

Then more eating, and the boys were headed for home. Altogether it was an outing which no one who participated will forget.

A BUGGY BOOST

After the Manner of the Automobile Paid Publicity Gink

Mr. Pinhead Buckwheat, a noted agronomist of Alfafa township, made a tour with the writer in the Flag-four (wheels), fresh from factory, and never before tried out.

Besides the two heavy-weight passengers there was 50 pounds of lunch and 10 quarts of oats. Notwithstanding the heavy rains that nearly blotted out the road, the varnish was not even dimmed, and all the paint on the body stuck it through to the end with a perfect score.

All the grades were taken on the running gear, yet some were so steep one could see over the brow of the next hill, but never once did the tires leave the mud, and the shoes (of the horse) showed hardly any perceptible wear. The motor at no time showed signs of distress, just pointing his ears "foward," switching his tail and sweetly performing the heavy duty without the least engine noise. The gear change gait was not once touched, and the transmission didn't bust a trace.

Considering the state of the roads this may fairly be called a remarkable performance. Not once did the motor heat up enough to cause distress or trouble, and the syphon cooling system for which The Flag is justly noted, worked without hitch at the water trough.

On the return trip Mr. Buckwheat took the driver's seat, and he had no trouble at all with the steering, never once touching the whalebone accelerator with his hand. This alone was evidence of how perfectly the motor was doing his work.

We did ten miles on a quart of "benzine," but could have used two quarts with satisfaction if we had thought to buy another bottle before starting on the trip.

Mr. Buckwheat has bought a "Flag," and says that when he wants to get there and back, a "Flag" is good enough for him. One of the outstanding merits of the "Flag" is its fifth wheel, which is a spare part that it not only carries, but also makes use of. This is a feature of our engineering department that was new once, but now universally copied. Another feature is the new cooling system, the water being drawn from the springs.

CLEVER AND TO THE POINT

Charles Dana Gibson is said by an exchange to have been amused at receiving not long ago a printed circular, signed by an automobile firm, that read:

"You are cordially invited to participate in our grand \$100 prize drawing contest. Each participant may submit one or more drawings advertising our automobile, and the winner will receive a grand cash prize of \$100. Drawings must be sent prepaid, they must be original, and all unsuccessful drawings will remain the property of the undersigned."

Mr. Gibson, who can scarcely be persuaded to make drawings at \$1,000 apiece, smiled over the printed circular, then took a sheet of notepaper, and, still smiling, wrote to the automobile firm:

"You are cordially invited to participate in my grand \$10 prize automobile contest. Each participant may submit one or more automobiles, fully equipped, of his own manufacture, and the winner will receive a grand cash prize of \$10 in gold. The automobile submitted should be brand new, and must be shipped f. o. b. New York. The unsuccessful automobiles will remain the property of the undersigned.

"Charles Dana Gibson."

MEYER'S THREAD

This thread ought to be tested by the few remaining who have not fallen into Mr. Meyer's way of thinking about his silks and threads for trimmer's use. This is a good deal to say, too.

THE ADAPTABILITY OF SHEET METAL TO ALL VEHICLE BODIES

The Intricacies of a Simple Operation Clearly Explained—The Subject of Moulding Metal by Machinery Described by the Expert Who Introduced the Art to the Trade, and Who Is the Only Recognized Authority, and the Inventor of Most of the Machinery Used for the Purpose



It is a trite and true statement that white wood for body panels has been a disappearing commodity for years. Fine clear lumber suitable for the body builder has not only been hard to procure, but its cost has been a large item of the expense of body building.

With the introduction of the new styles of bodies adapted to the motor vehicle, and the weight that such construction of the larger body made necessary, it was natural that something lighter and more suited to its purpose than wood could be was sought after. The new material was at first found in its best estate in aluminum, and the European builders were very soon at work experimenting on it.

Everybody recognizes their pioneer work in all that concerns the making of the automobile, everyone in the trade in this country has had to bow to this initiative, and to get the impulse from such sources, but when it came to Americanizing the methods by which the laborious handicraft of the European workman was simplified and made more accurate as well as more rapid, machinery had naturally to come into the equation, and the first manifestation of this new departure was born on the very ground and found in the very cradle where it ought to have been found, that is in Amesbury, known for so long as the inspiration of all that was best in the lighter forms of vehicle at the moderate price.

Thus it has come to pass that this moulding of metal by the means of machinery and machine worked tools, has become one of the conspicuous industries of the Massachusetts town, and what is more remarkable there has been such development and improvement and breathless progress, due to the very remarkable ability of Mr. Bela, who has been the pioneer in this new industry, that the "cradle" has remained the home and continued the headquarters of the art, and those who needed to know about the best methods of procedure, as well as to get a clear idea of the working of the best patented machinery for accomplishing the work, had to come and talk it over with

the gentleman above mentioned. This curiosity was not confined to this country. The hand workers from the European ateliers wanted to avail of this shorter and better way, and came to the source for both information and supplies.

It has occurred to The Hub that perhaps there was more of mystery about this subject of metal working than was warranted by the facts, and that some builders have refrained from investigating, thinking cost might be prohibitive, or the technics too confusing for any but the expert. We have learned that is not the fact. That the matter of the working of sheet steel or sheet aluminum has been made very easy due to the inventive ability applied to the making of the machines adapted for the purpose, when they have been designed right, as they could only be by some man who had had a long previous experience in the working of metal under every condition, usual and unusual, such as Mr. Bela brought to the subject from his long European experience in the best establishments. It is only to be expected that as a result of such knowledge this gentleman is the best equipped man in this country today, and we feel gratified that we shall be able to give to our readers a series of articles on the subject of sheet metal working that will be exhaustive and that will continue until the subject, month by month, will have been made clear to even the reader who has not the least present comprehension of the subject.

We do this in the belief that such a series of articles, appropriately illustrated for the purpose of making the text exactly plain, will be a contribution of real value to the progressive spirits in the business. As we understand it the subject will be gone into frankly and thoroughly and the intricacies, such as they may be, will be made perfectly understandable, but if there should be occasion to need clearer exposition, that will come in the discussion of the questions that are so likely to arise as a matter of course, as who can approach such an interesting subject without wanting to ask for light about something that may have been too readily taken for granted by the writer.

This subject of metal working for bodies is fast becoming more than an interesting subject, it is becoming urgent, because we must bow to the influence of the iron age that so certainly dominates our commercial life.

We see in the larger factories devoted to the making of the horse-drawn vehicle that the steel vehicle body has already made its bow to the trade, and it is fair to presume that it may not be long before the machinery of the metal body builder will be one of the accustomed sights in the factory. Why not? Strength, durability, light weight and beauty of line are called for not only because the sense of beauty desires them, but because competition commands their presence, and it is possible to accomplish all that may be wanted by means of the clever machinery and appliances we hope to fully explain. Today we have the automobile-body buggy, but what an eyesore it is as a piece of body work, and how vastly it is likely to be improved, and how very sure such a prophecy would be if the buggy builder had his own factory fitted with the machinery capable of turning out his thought in concrete metal shape, in place of having to go to a third party for the carrying out of his idea.

Due to the plastic material worked under the hammer it is fair to say that the only limit to the variation in form, sweep, curve, is the limit of the imagination of the carriage draftsman. All the hard problems of wood working that the body worker in wood tells us about so complainingly at times are swept aside by this metal that has the acquired habit of staying put when it is hammered into shape; and it is not subject to the vagaries of dampness, swellings, bucklings, etc., such as have to be expected sometimes in woodworking.

We hold no brief, of course, for any one style of body construction, but we do desire to exploit all that is new and advanced, and to arrange to have our readers told all about it by the one man best qualified to speak on the subject. We make this statement with a perfectly fair mind. There has always to be one supreme authority in any field of endeavor,

and it is a part of our duty to try and introduce such an authority on any special subject in our trade, if it is our fortune to find him and secure his consent to collaborate with us.

As we said, and now repeat, this metal working is no bugbear, and we are as much interested in showing that to be the fact when done in the right way with machinery properly designed, as we are to point to the profit of the undertaking.

The automobile maker has pointed the way to the magic of the forms that may be produced under the light strokes of the power hammer, but there have been those who have not fared very well when they undertook to do likewise, but that is all the more reason for instruction, exposition, explanation, and the place to find that is in the experience of the man who knows how because he has blazed the path to all that is known on the subject, and has been the one that has had to be copied, if the same subject was taken up by others.

A very convincing thought along these lines is that in this new industry, where the field for the imagination must necessarily be broad, we yet have found no new forms or designs of the machinery necessary to do the work, except such as have been designed by the one who made the forms in the first place, which seems to show that there is a master mind.

We can only hope that readers of *The Hub* will enjoy this exposition that will be given from month to month by Mr. Bela, and that they will profit by the information.

Next month we will tell something about this genius of the plastic metal, A. Gottlieb Bela, that is sure to arouse an interest in his remarkable work. We want all interested in the technics of the trade to concentrate interest on the articles to follow, and get real first-hand information.

MOTOR CARS IN SOUTH AFRICA

Consul E. A. Wakefield, Port Elizabeth, says it is probable that South African motor car importations during 1913 exceeded those of any other country in proportion to the population.

Popularity of Motor Cars

There are several reasons which may be held accountable for the popularity of motor vehicles. (1) Towns are not close together, and in the case of adjoining farms the homesteads may be several miles apart. (2) South Africans are sportsmen to the core. (3) Every town of importance has its golf links, cricket and football grounds, tennis courts, bowling green, and rifle range. (4) The motor car is decidedly popular as a means of conveyance to and from the grounds. (5) The motor taxi is rapidly superseding the horse-drawn vehicle as a public conveyance in all towns of any size. (6) The agricultural shows of this year afford ample evidence of the popularity of the motor car with the farmer and gave practical demonstrations of the extent to which he relies upon this method of transport. (7) In the towns the motor car is rapidly supplanting the horse for pleasure riding and is beginning to be used for commercial purposes.

Road Conditions—Classes of Cars Used

Considering the comparatively sparse population the roads are fairly good and are being steadily improved. The country is naturally rugged, with many hills and drifts (stream crossings without bridges) and a considerable proportion of sandy roads. In other places the roads are very rocky, so that taken all together a good clearance (at least 10 inches) is a necessity. In the towns the roads are usually of crushed rock and reasonably good.

The medium to low priced American cars are decidedly the most popular and most readily sold. Much less is heard about the cheap American car at this time than formerly. They have been thoroughly tried out and apparently have been found satisfactory.

Outside the medium priced article American cars have as yet been little used in this district. The idea still prevails that if a car costing \$2,500 or more is desired the European car is

superior to the American product. It is difficult to account for this, inasmuch as none of the high priced American cars have ever been sold in the district. Undoubtedly they will come eventually, but that time has not yet arrived, nor are the conditions at present particularly favorable.

Business Conditions—Imports

South Africa is at present in an unsatisfactory position from a purely commercial standpoint. Two severe droughts in succession, coupled with serious labor disturbances and the slump in the ostrich feather market, are responsible for the present trade depression. How long these conditions will continue is a matter of conjecture. The fact that in the large commercial houses business interests are anything but optimistic should be sufficient information as to prospects for the immediate future.

The magnitude of the motor car trade in South Africa is shown by the importations for 1913, when the total imports of cars and parts totaled \$5,400,000.

FACTS KEEP COMING

In a recent circular letter from the Studebaker Corporation, of South Bend, Ind., to its sales department, the following information was included: "We have all had an opportunity to see auto trucks go to pieces faster than any other investment we have ever known. The big cities of the east, which caught the disease first, have naturally been the first to pay the price, and the first to recognize their error. In Detroit, where a dozen auto-truck manufacturer will gladly install an outfit at cost to have their trucks on the street, the user who has to pay the bills has learned how expensive the auto truck really is." They also state that there is a revival in the trade for horse-drawn vehicles, and that they are shipping a trainload of horse-drawn vehicles to one transfer concern in Detroit, the heart of the automobile industry.

This information is important, coming from such a concern as the Studebaker Corporation, which has an international reputation as makers of both wagons and motor cars.

PARRY AND PUSH

Wm. F. Habig, special traveler for Parry Mfg. Co., is making a special two weeks' trip through New York and Pennsylvania territory.

W. E. Campbell, in Alabama, has been traveling temporarily in Georgia on account of the illness of C. P. Thomas, the regular Parry traveler for Georgia and Florida. Mr. Thomas reports that he is much improved at present and will probably be able to take up the reins again himself next week.

S. A. Dinwiddie, who formerly traveled in southern Missouri, has been transferred to Kansas.

Wm. McMorrow, in Missouri, spent a few days at the factory in Indianapolis.

Mr. E. R. Parry and wife have returned from a two week's sojourn at Maple Grove Springs, near Chillicothe, O. Mr. Parry is vice-president of the company.

A. M. Parry, secretary, has taken his family for a one month's stay in Michigan during the heated season.

H. O. McDaniel, in southern Ohio, spent a few days at the home office.

Chas. T. Platte, traffic manager, who in his spare moments is a very successful fisherman, is spending two weeks pursuing the finny tribe, in southern Indiana.

TRADE BOOSTING, NEW STYLE

Trade boosting by automobile has been adopted by the Pittsburgh Commercial Club. July 16, 100 Pittsburgh merchants and dealers in various commodities started on a tour of western Pennsylvania in motor cars. Heretofore the trade boosting tours have been done on special trains.

Industrial Safety in Buggy Factories

Owing to the broad-gauge policies of Editor Keogh, of American Industries, a safety appliance supplement that it seemed to us of especial interest to wood workers, has been arranged for this issue. The National Manufacturers' Association has made liberal expenditures to teach safeguarding of life and limb in the workshop through its accident prevention department, and we think it a duty to co-operate. These illustrations are described under the title

Safeguarding the Jointer

While the circular saw is credited with causing more injuries than any other wood-working tool, this fact only remains true because of the great number of these machines in use, as the jointer is equally if not more dangerous, and the injuries inflicted, especially with the old type of machine, are usually of a more serious nature. Like the saw, the jointer is a very common and necessary tool in all shops where wood-working operations are done, and even with the most experienced operators and the best type of safeguards, the work cannot be considered safe. This is true because of the close proximity of the operator's hands to the rapidly revolving knives, also the fact that the safety of the operator rests wholly on the hands for controlling and manipulating the work. As the stock is pushed over the knives, some pressure must be exerted to keep

it in place, and to insure satisfactory work, which always brings the hands directly over the gap in the tables and very near the danger point. This requires a careful operator, one whose mind is always centered on his work, and who thoroughly understands the setting and operating of the machine.

There have been many guards devised to improve the safety of this hazardous machine, but the one that will do more to prevent accidents or decrease their severity is the safety cylinder. With the old square head type the opening between the tables and knives is very much greater than with the circular head and once the fingers are struck by the knives they are pulled further in and the major portion of the hand is usually mangled. The circular head, on the contrary, fills the opening so that there is no space left for the fingers, and the injury, except in very rare cases, does not result in more than clipping the finger ends. Another feature of the circular head is when the back table is set too low or when short pieces are being run, the knives have a tendency to cause the work to tip and throw the hand into the cutter head.

The circular head does not complete the guarding of the jointer, as it is also advisable to place a guard, either automatic or adjustable, over the knives, as a further step toward safety. There is a large variety of such guards manufactured, having more or less merit, which can be used on many classes of work,

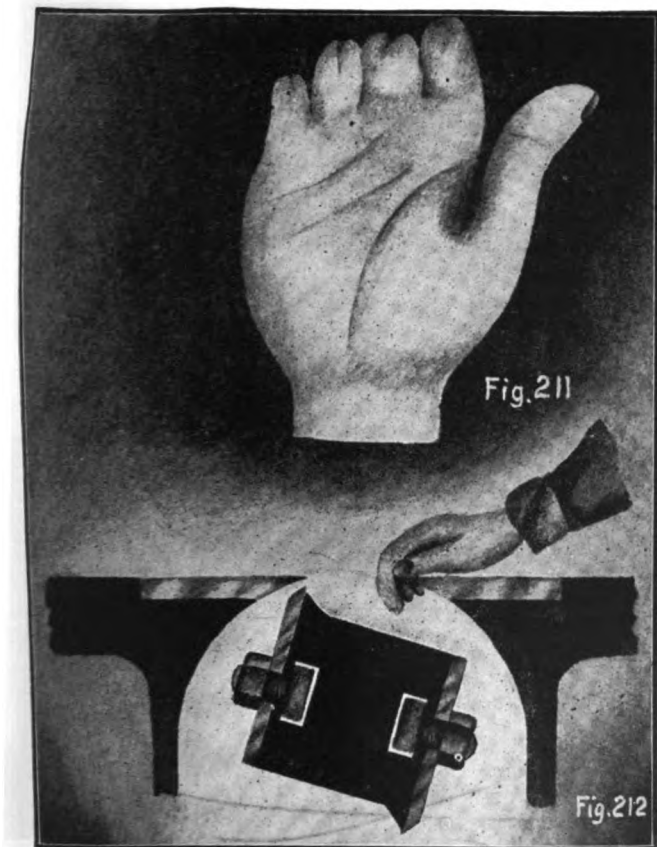
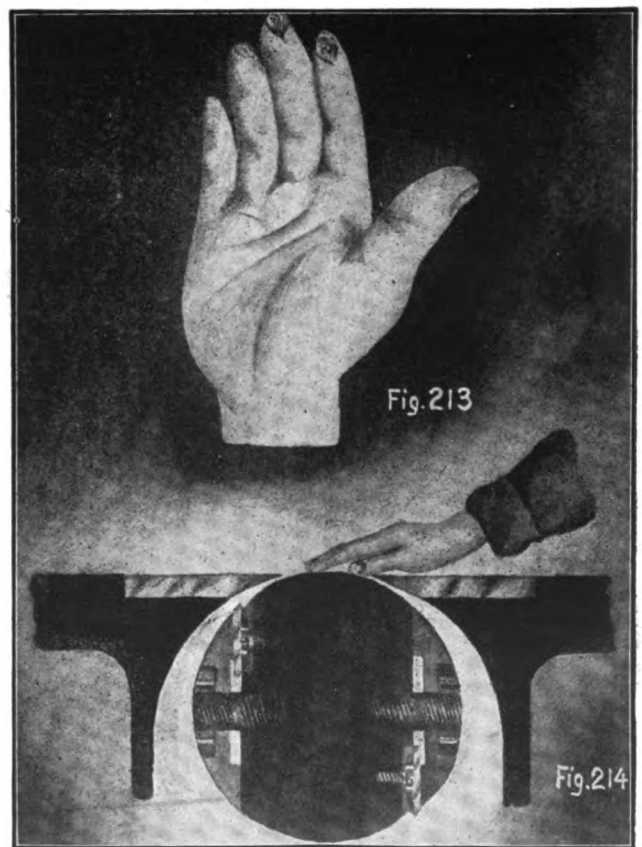

Fig. 211. (Effect) shows the disfigurement of a hand, the result of an accident on a jointer equipped with a square head. Owing to the large gap, the hand may be drawn in with the result shown.

Fig. 212. (Cause) shows the unsafe type of cutter head frequently found on older styles of machines. Note should be taken to the gap between knives and table.



Figs. 213-214. (Prevention) shows safety circular head and the finger tips of a hand that has fallen into the knives. This cylindrical cutter head does not permit the hand to be drawn in and suffer serious injury. This type of cutter head is the most efficient guard that can be placed on the jointer and will eliminate or materially decrease serious accidents on this machine.

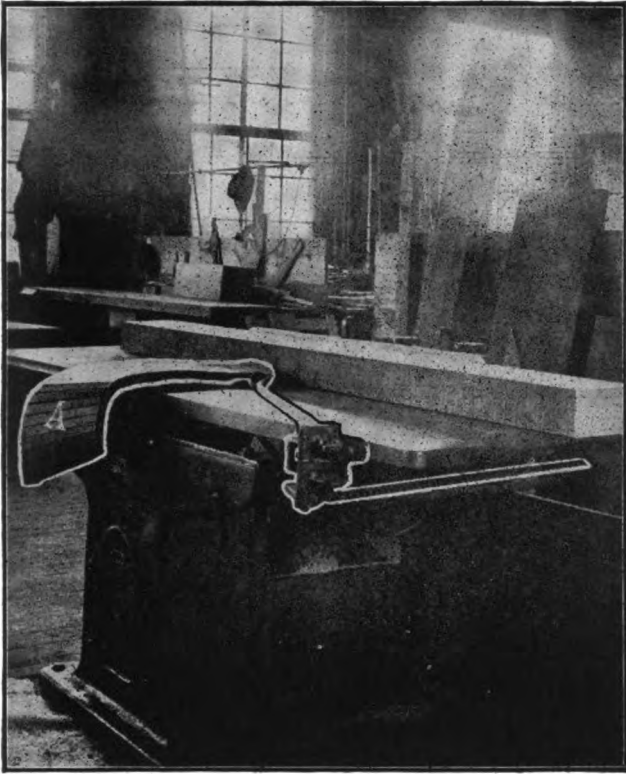

Fig. 2. Shows the application of the Champion guard, which is equipped with a spring that keeps the portion of the knives covered that are not occupied by the board. This guard is composed of flexible sections which drop over the edge of the table so as not to project and be in the way of the operator.

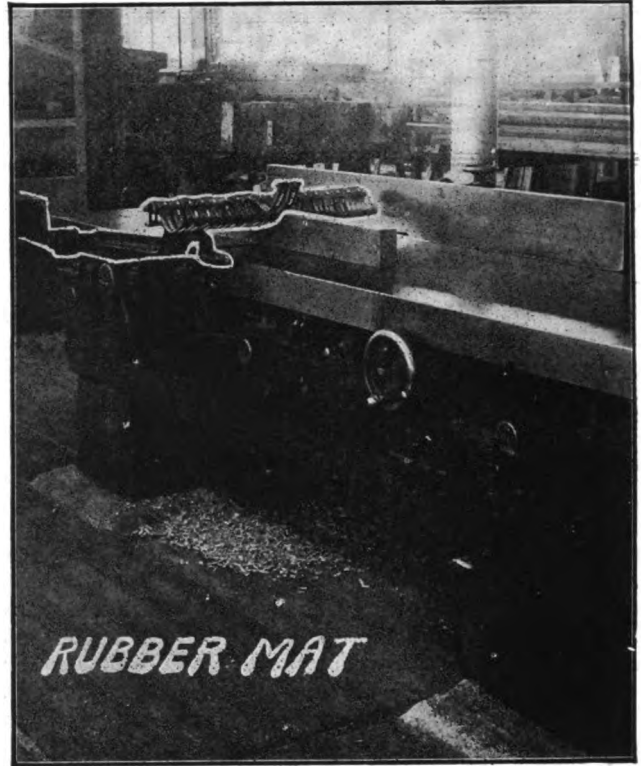

Fig. 4. Shows the Frank Howe guard, which is of very novel design. The guard is composed of a number of hinged segments that raise as shown for the admission of the board.

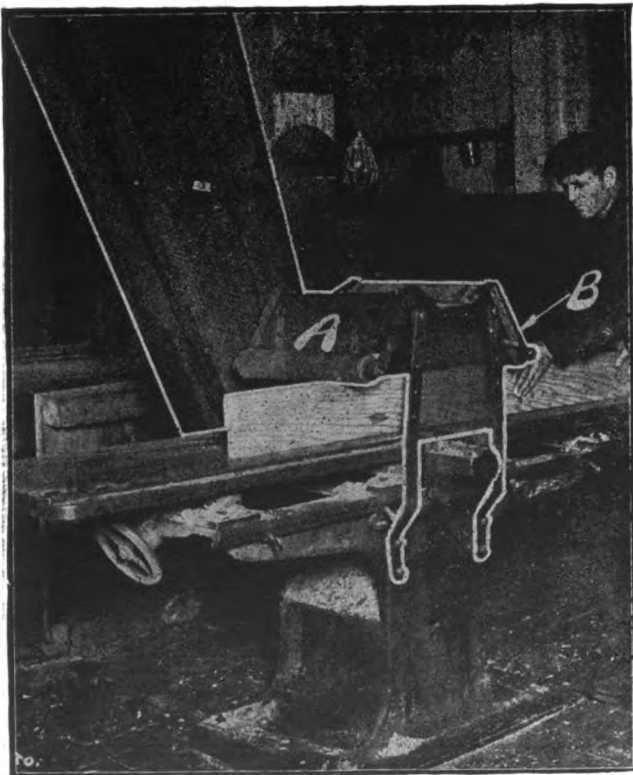

Fig. 3. Shows the most simple type of wing guard such as can be easily made in any wood shop and at a negligible cost. The guard is not automatic, but can easily be made so by the attachment of a spring or counterweight.

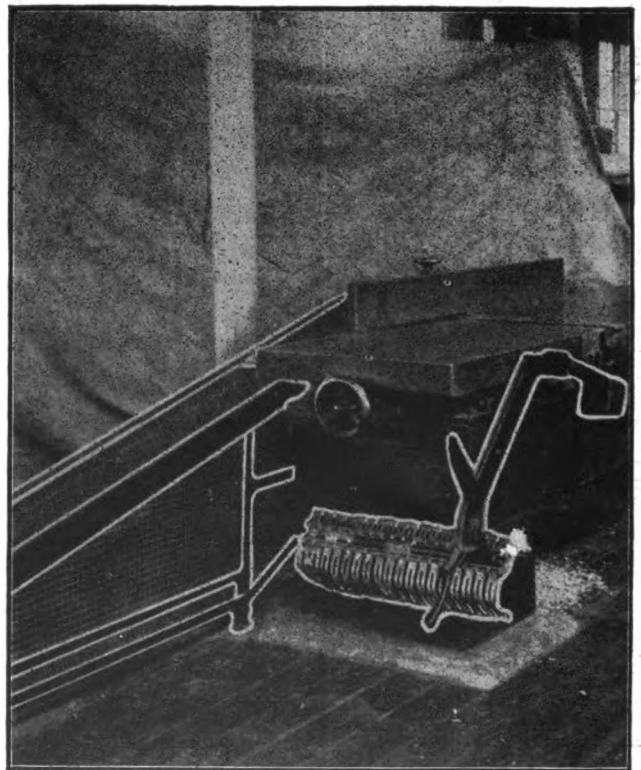

Fig. 5. Shows a method of swinging the Howe guard out of its position when it is necessary to do big work on the machine. Notice the neat construction of the belt guard, which is a good standard to adopt, being preferred to wood since it is fireproof and durable. Both of these views show the floor having a rubber mat to prevent slipping.

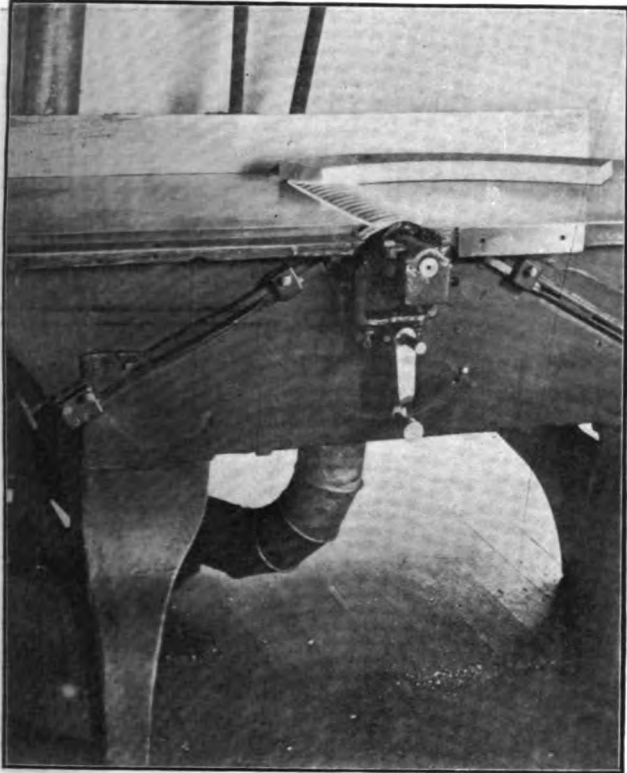

Fig. 6. Shows a guard composed of a number of fingers that cover the knives completely except that portion required for the width of the stock. The fingers when engaged by the end of the board rotate over the back table and are returned again by means of a counterweight to original position over the knives after board has passed.

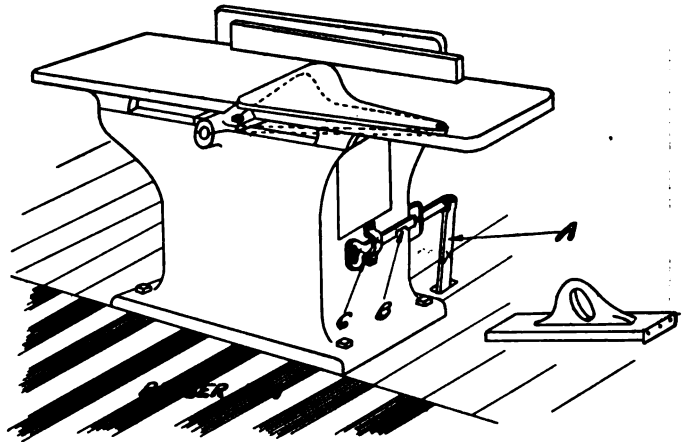
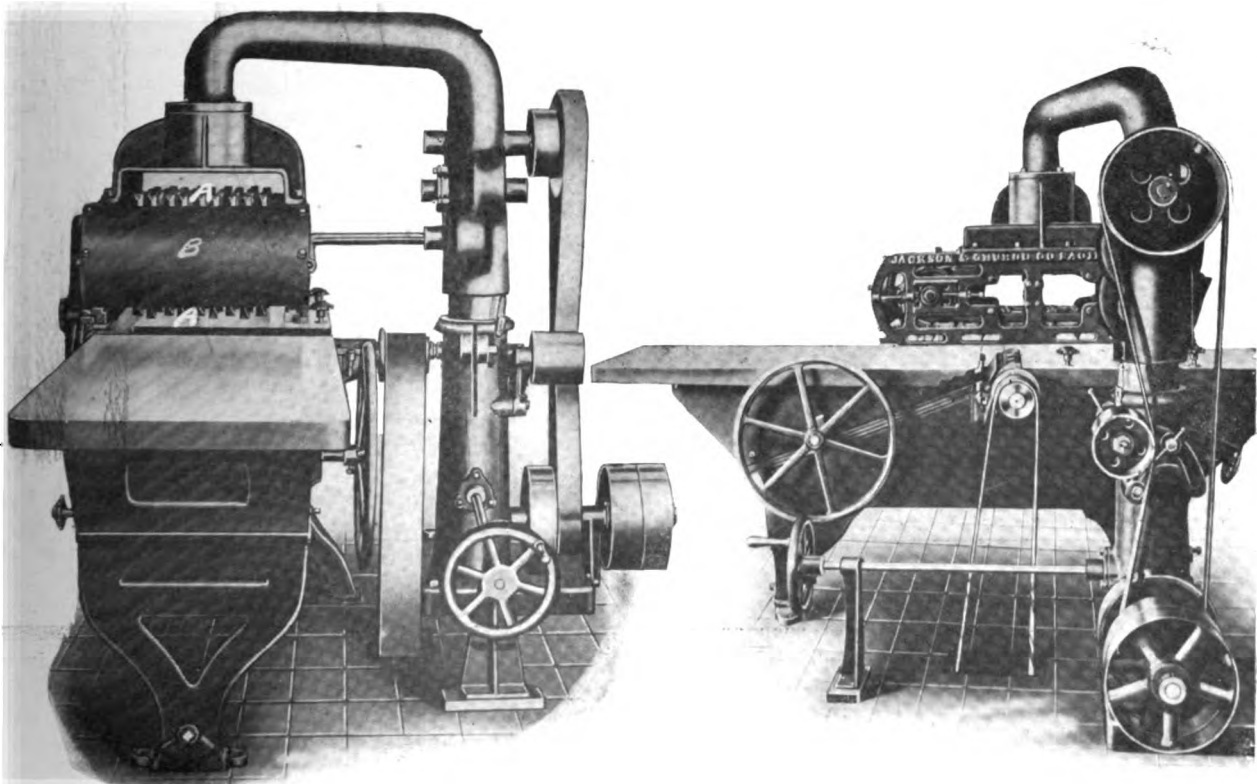

Fig. 225. This shows an adjustable guard that consists merely of a wooden wing such as can be constructed in almost any shop. It is common practice to fasten this type of guard to back of table, but in this case it is fastened to the front of the table. As the stock pushes the guard away from the guide it projects over the edge of the machine and as the operator's body comes towards the knives it exerts a pressure on the guards which forces it back into place after the board has passed through. Often an automatic guard that is actuated by either a spring or a counterweight, is objected to because of the extra pressure required to force the stock past the guard which one of this type may tend to overcome. At A is shown a locking belt shifter that locks in place by means of notches B and C. Note should also be taken of the rubber mat on the floor along the side of the machine.



Figs. 221-222. Shows two views of the self-feeding jointer attachment that will entirely eliminate the possibility of the operator getting his fingers caught in the knives while feeding material. The feeding device consists of a number of fingers as shown in A attached to an endless chain arrangement which engage the material and complete the cut. At B is shown a sheet metal guard that encloses the fingers and prevents injury to the operator from having the clothing caught and the arm thrown into the cutter head. Where a large amount of short work must be done this arrangement is extremely valuable not only in decreasing accidents but also in the increase of production.

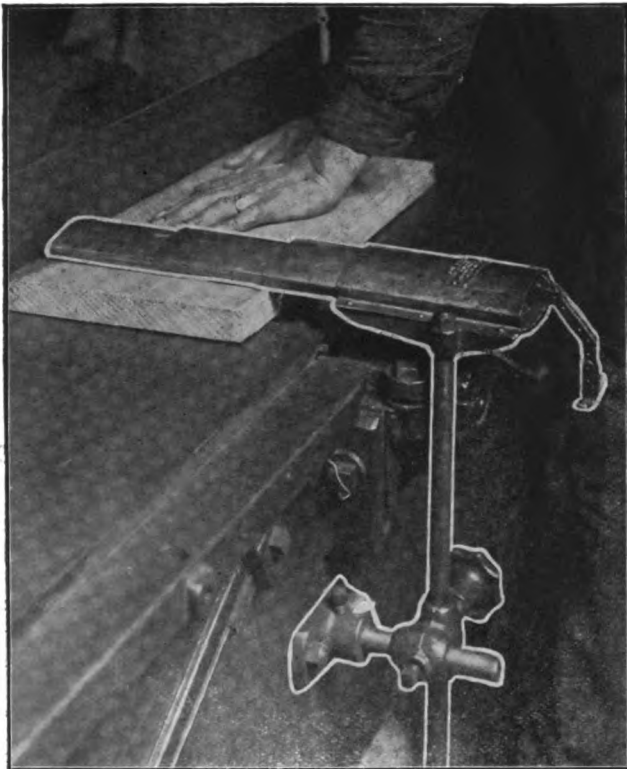

Fig. 223. Shows the well known Jones telescoping guard which covers the space directly over the knives. When edge work is being done the guard can be pulled away from the guide, the various sections telescoping into each other. When large work is done and a guard is not required it can be swung out of the way at the side of the machine.

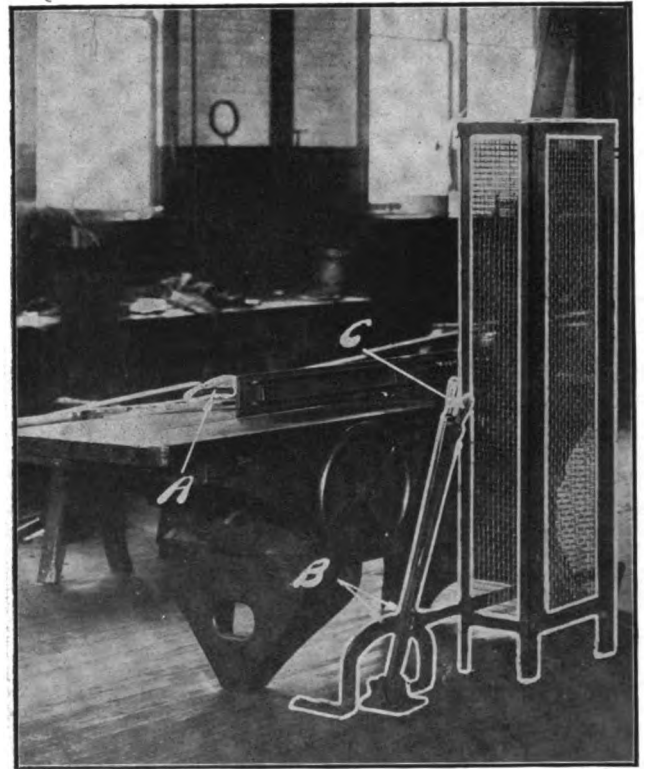

Fig. 224. Shows a jointer with a Champion guard at A. Note should also be taken of the angle iron and wire mesh belt guard and locking belt shifter, which eliminates all possibility of the machine being accidentally started while the operator is adjusting the knives. Before belt can be shifted it is necessary to raise latch at B by means of lever C.

while in some cases even the best of them are impracticable and the circular head is the only guard available. Such a guard has another feature in keeping the portion of the knives covered that is not in use, thereby preventing one unknowingly placing the hand in a position that may cause injury. When the edge of the stock is being jointed there is no need to keep the entire length of the knives exposed, as instances often occur of a workman passing a machine and laying his hand over the knife, or the operator slipping and the fingers being thrown into the knives.

A frequent cause of jointer accidents is due to the operator attempting to plane a piece that is too short to be held with safety, which results in its tipping or kicking back, throwing the hand into the cutter head. In Germany among wood-working associations, it is a rule not to permit pieces shorter than 15 3/4 inches to be jointed on a hand planer unless special precautions are taken to hold the material.

While it is difficult to set a minimum length, it is always advisable to use a push block or other holding device, should there be any possibility of an accident resulting because of short material. Where there is a large amount of short work to be done, a self-feeding attachment will aid materially in eliminating accidents from this source. With such arrangements it is only necessary for the operator to push the material to a point where it will be carried to the knives by the means of rollers, spurs or fingers, thereby not requiring him to place his fingers in a dangerous zone.

One that is familiar with wood-working operations has often noticed the slippery condition of floors around saws, shapers, jointers, and other wood-working machines and can readily understand what the result may be should an operator slip or fall while working in their vicinity. Because of the hazards connected with jointer work such a floor condition should not be permitted to exist and the danger removed by placing a

rubber mat, old belting or other non-slipping material on that portion of the floor utilized by the operator.

Table Showing Jointer Accidents Reported, by Nature of Disability

Guarded or unguarded machines.	All accidents.	Total fingers cut off.	Hand cut off.	Fingers cut off.				Lacerations or abrasions.
				Four fingers.	Three fingers.	Two fingers.	One finger.	
All accidents on jointers	77	71	1	4	2	11	27	32
On unguarded jointers	53	59	1	4	2	9	19	18
Guarded only with movable slide	22	12	2	8	12
Guarded with safety head	2	2

The Industrial Commission of Wisconsin, which has taken a very prominent place in accident prevention work, has chosen the jointer as the most necessary machine in having attention called to its dangers and has devoted the first of the shop bulletins to this subject. The following, taken from Shop Bulletin No. 1, shows the injuries credited to this machine in Wisconsin alone for a period of 15 months:

"Of all of the hazards of the wood working industry none is so great as the old fashioned square head jointer or buzz planer. The annual harvest of fingers and hands in this state alone is appalling. Four out of every 100 accidents in this industry occur on jointers. No other machine on which any number of accidents occurred—with the exception of corn shredders, and feed cutters—has caused so many permanent disabilities in proportion to the number of accidents. Of the 77 accidents reported, 44, or 57 per cent., resulted in the loss of one or more fingers. In one case the operator had his entire hand removed. In all a total of 71 fingers or parts of



CAUSE

HOW ACCIDENTS HAPPEN

Fig. 7. Shows an unguarded jointer equipped with a square cutter head and operator attempting to plane a short piece.



EFFECT

Fig. 8. Shows the result of a short piece tipping up and throwing the operator's hand into the knives.

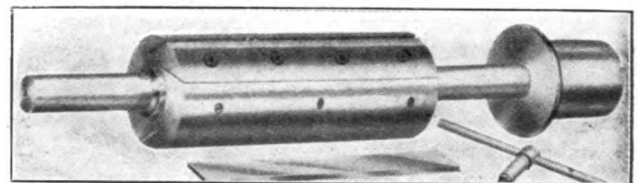
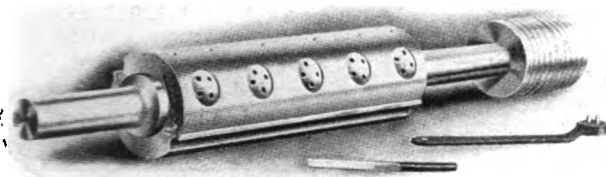

PREVENTION

Figs. 8-9-10-11. Show various designs of the circular safety heads for jointers that can be easily applied to replace the old square head type and thereby removing the greatest element of danger on this machine.

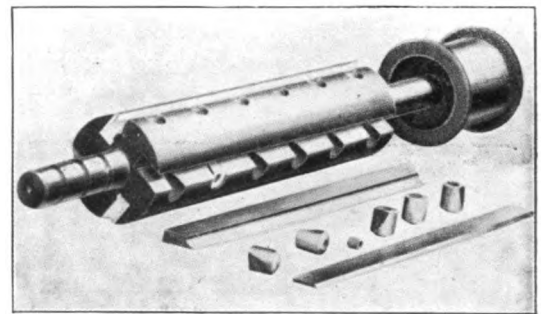
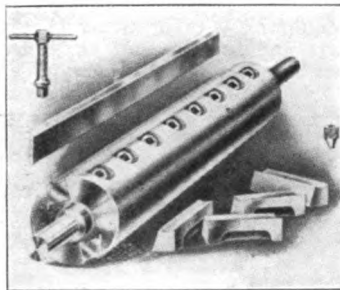

fingers, and one hand, were cut off by these machines. In four cases four fingers were cut off, in two cases, three fingers, in 11 cases, two fingers, and in 27 cases, one finger.

"All but two of these accidents occurred on the square-headed jointer. In the two instances reported, in which the machines were equipped with safety cylinder heads the injured person merely suffered a slight abrasion at the tips of his fingers. Germany has long since prohibited the use of this old type of 'head.' Order 200 of the Industrial Commission reads as follows:

All hand jointers must be equipped with safety cylinder heads, and a guard must be placed over the knives to protect the hands of the operator.

"If this order had been complied with, it is safe to say very few of these accidents would have occurred. At least 44

people would today have the use of their fingers, instead of being maimed for life. The cost of installation is comparatively cheap, the average cost being about \$50. According to the compensation payable in some states for the loss of fingers or hands, the amount of money which employers would have had to pay for the injuries sustained on jointers would have paid for the installation of new 'heads' on over 300 jointers. This guard, with the addition of the guard as required by Order 200, will make employment on these machines comparatively safe.

"The table above shows that 53 of the accidents occurred on machines without any sort of guard. In 22 cases the machine had merely the movable wing. Even this guard without a safety head furnished partial protection to the workmen. Of the 22 cases, only 10, or 45 per cent., resulted in serious



Fig. 12. Shows an automatic wing guard that is composed of three leaves and equipped with a spring so that it automatically returns to its position to entirely cover the knives after the board has passed through.



Fig. 13. Shows the same guard, but with the leaves telescoped when side stock is being worked. The feature of this guard is that it does not project beyond the edge of the table and prove a hindrance for the operator.

injury, while of the 53 un-guarded jointers, 44, or 83 per cent., resulted seriously. In the 15 months only two accidents occurred on jointers guarded in compliance with the Commission's orders. Both accidents caused only slight injuries."

The result shown in this one state is only an example of what is occurring everywhere in the wood working

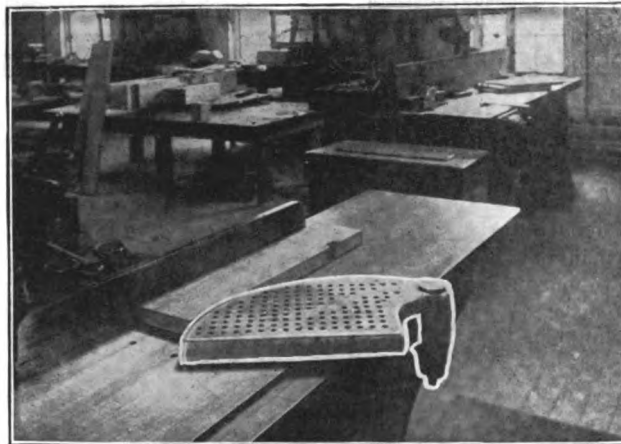

Fig. 14. Shows an automatic wing guard made of perforated aluminum in order to make its construction as light as possible. This guard is equipped with a spring that automatically returns it to the gauge and assures that portion of the knives not needed by the stock is covered at all times.

industry, and when 71 fingers and one hand are lost on one kind of machine in 15 months, it is surely cause for action. The economic loss of the above accidents based on compensation wage loss and medical aid, if expended on proper safeguards, would eliminate many further accidents, not to mention the pain and suffering that accompany them.

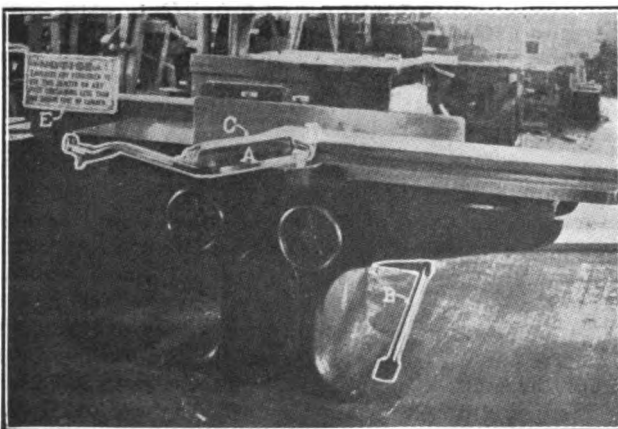

Fig. 15. Shows a spring actuated automatic wing guard A equipped with a lever B to adjust the opening of the guard for the stock when both hands must be used to hold the work. When only one hand is required the guard can be adjusted by handle C. To guard A is attached a shoe D to reduce friction and E is a warning sign to caution employes not to joint any piece on this machine containing less than one square foot of lumber.

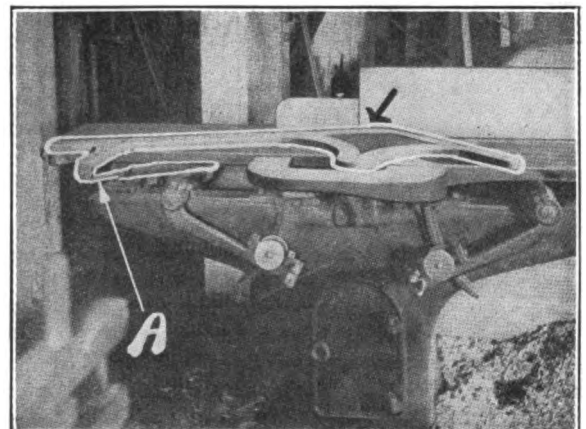

Fig. 16. Shows a home-made automatic wood guard actuated by a spring shown at A. On the curved part of the guard against which the material comes, is attached a strip of metal which aids in reducing friction between guard and stock.

Paint Shop

BRUSHES AND THEIR MANUFACTURE

The best painting brushes at the present time are costly, and will be more costly in the future, in view of which it is desirable that the painter should know as much as possible of the capabilities and characteristics of his material, in order to enable him to use it to the best advantage.

Although brushes have, from very ancient times, played so important a part in the daily life of all people, few have ever troubled to enquire into their mode of origin, and even a dictionary definition is unknown to many. Probably the word is derived from a bundle of brushwood, used as a broom or brush, and the earlier forms of brushes consisted of a bundle of some fibrous material tied onto a stick, which practically describes most brushes used at the present time, notwithstanding the several refinements introduced in the stocks or handles themselves, and in the methods of attaching the fibrous materials to them.

The most important, however, of all the materials used in brush making is of animal origin, and consists of the hairy covering of pigs, horses, badgers, sables, or Martens, oxen, squirrels, goats, skunks, bears, etc., of which the most important contributors, both as to quality and quantity are the pigs, from the backs of certain breeds of which the stout elastic hairs are obtained, which are known as bristles.

True bristles are only obtained from the swine family, which is a very widely distributed one, comprising the wild boars of Europe and Asia, and the more or less wild and domesticated varieties of pigs found in Europe, Asia and America.

In Spain, Austria, Germany, Russia, China, and India, wild boars are still found, but it is in Russia, and especially in the vast territories of Siberia where the bristle producing animals abound, and where the finest bristles are procured. Bristles of a somewhat soft and silky nature are obtained from the more or less domesticated hogs of France and Germany, but the more domesticated pig, the less bristle he grows, and the greater becomes the value of his flesh.

The quality of the bristle grown varies with the season of the year, winter growths being much stiffer and longer than those of the summer months. In the same way the better bristles are obtained from the coldest regions.

Chemically, a substance called Keratin forms the chief constituent of bristles, as well as of claws, nails, feathers, horns and wool.

A mystery envelopes the methods employed in collecting bristles from the wild boars and pigs. These animals inhabit very remote regions where there are very few people, and the possibility of the enormous quantity of bristles that are used being obtained as a result of the chase, seems out of the question. It is also hardly credible that animals of such a fierce nature could be subjected to any process of bristle removing while alive, and if the animals were slaughtered, one would expect that the race would have been exterminated long before this. One explanation suggests that the animals shed their bristles by rubbing them against the trees in the forests, and the peasants gather them in small quantities at a time. However, they are collected, there is no doubt that it is done by a large number of small collectors in the first instance, who sell to larger factors, until at length they get into the hands of the dresser, who prepares them for the market. At the present time the principal market is held at Leipzig four times a year, the most important fair being held at Easter.

Bristles are classified according to their length, stiffness and

color, the longer and stiffer the variety the higher the price, but higher still when the color is white, or Lily (as the term is), though the quality may not be in any way superior to that of black, yellow or grey. Generally speaking, the stiffness of bristles varies in proportion to their length, very stiff bristles not as a rule being found among the very short lengths, although it does not follow that all long bristles are stiff. The longest and stiffest hairs always grow on the spinal regions, sometimes reaching as much as 13 inches in length, and get softer toward the flanks.

The value of a bundle of bristles of a specified length depends on the proportion of that length contained in the bundle, for instances, bristles purchased as six inches long, invariably contain many of shorter length, thus reducing considerably the worth of the bundle.

Bristles are imported packed into casks holding from 3 to 6 cwt., partially prepared or dressed, and sorted roughly into lengths and colors, and tied up in bundles varying in many ways according to their country of origin. Siberian bristles are tied up in bundles of moderate weight with a very small quantity of bark. Those from Poland are quite differently bundled, being tied up in small knots, with a large quantity of heavy cord or bark. From some districts the bundles are very large, with a minimum of tying material, while from others large bundles are tied up with as much cord as can be used. Chinese bristles are done up in small bundles, two being wrapped in paper and packed in small cases of about 1 cwt.

The amount of dressing to which the rough bristles are subjected, differs considerably in different districts, in some being sorted and bundled by length and stiffness, while in others, lengths, colors and qualities are mixed together in each bundle.

The difference just mentioned make it quite easy to tell the district from which a particular bundle of bristle has come, but all districts are alike in sending their rough bristles with as much dirt as they can hold. This commodity, and the tying material are evidently considered by the dressers as of the same value as the bristles, and it is not to be wondered at that as much is added as their consciences will allow. A peculiarity of all bristles, and one that is met with in the hair of no other animal than the pig, is the tendency to split at the fine end. This dividing up of what is technically called "flag" of the bristle, goes on during wear, and thus continually produces in the brush that soft velvety surface which enables the paint and varnish to be evenly spread on the work, and it is owing to this peculiar quality of bristles that an old brush well worn, is so much prized by its owner. This peculiarity is an infallible test for determining a bristle.

Another characteristic of the pig's bristle, and one that is also made use of as a test, is the size of the root end in comparison with the "flag," it being thick at the root and gradually tapering towards the "flag." The taper varies in degree in different types of bristles, those from Siberia being straighter than those from China.

The sides of a bristle, which appear to be as smooth as a piece of wire, are really somewhat jagged or serrated like a saw, the teeth always sloping from the root towards the "flag." Although this is common to many hairs, it is especially valuable in the bristle from a brush maker's point of view, for it enables it to be moved more freely in one direction than another. When the roots and "flags" of bristles get mixed up heads and tails, as it were, this serration of the edge enables them to be easily turned, so that they arrange themselves all in one direction.

The actual process of turning consists in spreading a thin

layer of bristles on a flat bench, and rubbing them with a flat lath, backwards and forwards, under slight pressure.

Although bristles are among the hardest and most durable of all the hairs, and appear to be so strong and indestructible, they are, in reality, very easily destroyed by contact with certain solutions, or any matter liable to decay. Boiling water containing much common soda soon reduces them to a jelly. Lime, or caustic soda also quickly destroys bristles, altering them from being very hard and elastic to a harsh and brittle substance without any spring. Bristles kept in the damp soon decay and lose all their strength.

In the case of brushes used in glue, the rapid gelatinizing of the bristle is sometimes brought vividly to one's notice when the brush has been left boiling with the glue. It then becomes difficult to distinguish the brush from the glue, and the user lays the blame on the manufacturer for using inferior bristles.

Bristles, along with all hairs, absorb very readily, and become swollen and softened when wet. This properly accounts for what is really a source of annoyance to brush users; the knots of certain brushes becoming loose after being used in water. The bristles swell considerably in water and become exceedingly tight in their bindings, but on drying they shrink, and may get so loose that the brush comes to pieces.

Horse hair from the manes and tails, is the material most extensively employed after bristles, but when used in the manufacture of painters' brushes, it must be regarded as an adulteration, for it possesses none of the qualifications of bristles, and is used solely on the merit of its low cost.

The best quality is produced in England, but supplies are also obtained from Russia, China, South America and Australia.

The advent of the motor vehicle is having a serious effect on the supply of horse hair, which has considerably advanced in price during recent years.

The preparation for the market consists in cleaning and sterilizing and straightening, or as it is termed "drafting" the hairs, and it is this process which has given the trade definition of "Drafts" to horse hair. Drafts are sold in tails, or bundles, of about 2 inches diameter, and up to 20 or 30 inches in length.

Compared with bristle there is hardly any tapering, each hair being nearly equal diameter at both ends. Horse hairs have no tendency to split, and in wear act in much the same way as a piece of soft wire on being filed.

The length makes no difference in the stiffness, which, at its best, is much softer than common bristles. The fact of it being obtainable in long bundles, which can be cut to any desired length, makes it very tempting material to fill up the deficiencies in long bristles, which contain large proportions of short lengths. The price of horse hair being the same for any length, makes it more profitable to use in the long lengths, where bristles become so costly, but the greater the length used, the poorer the quality of the brush.

The hair of several varieties of the Martens or sables is used in artists' pencils and decorators' writers and liners, and the squirrel provides the material commonly known as camel hair.

It is the tails of the sables and squirrels that are used, and the hair comes almost naturally to that fine point which is so much appreciated.

The hair from parts of the ox is used principally for lining pencils, and it is also employed to mix with some of the softer varieties of sable.

Goat hair is a very soft material, and mixed with other furs produces the cheaper grades of camel hair.

Skunk and bear hair are of moderate stiffness and are used for very fine flat varnishes, and some artists' brushes.

The vegetable fibres used for brush making comprise the following: Mexican fibre, from the agave and aloe; manilla, a sort of hemp used in conjunction with Mexican fibre; piassava (bass), from Brazil; palmyra fibre from Ceylon, a sort of soft bass; cocoa fibre, from the outer shell of the coconut; kittool, whisk, etc. Most of these fibres come from the stems or leaves

of certain palm like plants, and are prepared for the market by being combed up to about 20 inches.

In making brushes suitable to the various uses to which they are put, the first consideration is the selection of the raw materials best fitted for the purpose, and then putting them together in right proportions. For instance, in a good varnish brush, the bristles must be very elastic and have a good substance at the "flag" end, or be, as it is technically called "solid." For heavy paint and distemper work, it is not an advantage for the brushes to be too solid at the top, but the bristles require to be nicely graduated so that they may come together in a more or less pointed manner.

When the selection of the various lengths and colors and stiffnesses has been made, they have to be thoroughly and evenly mixed together so that any portion will be the same consistency as the whole.

In the case of a job of say 10 cwt. or 6-in. distemper bristles, the proportion of all the ingredients are ascertained by counting the number of bundles of each sort, and the workman, or "hair sorter," as he is called, commences by laying out rows of the different sorts one on top of another, until the whole 10 cwt. is accumulated on the bench, forming perhaps a wall of bristles several feet long, 18 or 24 inches thick and 2 or 3 inches high. This wall contains layers of the various colors, lengths and stiffnesses, differing in stiffnesses proportionately to the quantities. Supposing there were four long rows consisting of several layers, each row will consist of the same proportion of each sort of bristle.

For the process of mixing these together, the workman proceeds to cut down through these layers from top to bottom, obtaining from one row a handful of bristles, consisting of all the ingredients in their proper proportions. These are mixed together by a method of halving the handful and combing at the same time, and by repeating this the layers gradually become thinner and thinner until they almost disappear when the handful is to be half mixed and is again laid out in rows on the bench.

This process is continued until about 50 lbs. is half mixed (made up of an equal number of handfuls from each row) and rowed down in a smaller wall when the original process is repeated, and the resultant bristles are thoroughly mixed together.—The Decorator (England).

HOW TO TEST OIL AND TURPENTINE

The successful painter is to a greater extent dependent upon the quality of oil and thinners which he uses than upon any other materials. This is due to the fact that the average paint contains a larger quantity of oil than of pigment and color, and because the durability of a paint is largely determined by the quality of the oil used in its manufacture.

The results which follow the use of paints containing grossly adulterated linseed oil, are usually very unsatisfactory. If the new oil is impure, the paint in which it has been used may show a different appearance from the paint in which the pure oil was used. Under such conditions, the painter would do well to test his oil before using it, if he has any doubts as to its purity. Although the services of a trained chemist are necessary to determine with accuracy the percentage and character of adulterants in a faked oil, there are, fortunately, a few simple chemical tests which may be made by the painter himself, and which, when properly carried out, will give him much information as to the purity of the oil he is using. For everyday practice, the following observations may be made by the painter who desires information as to the quality of the raw linseed oil he is buying.

Pure linseed oil has a peculiar odor of its own, which every user is acquainted with. This odor has been described as being similar to that of the odor of molasses. This is especially true of oil which is freshly crushed from the seed. Although the smell test is of no great value in testing an oil it is quite useful

in some cases. If a small quantity of linseed oil is briskly rubbed between the palms of the hands, it will become warmed and its odor becomes more prominent. The presence of rosin oil as an adulterant will be made known by the peculiar tarry odor of this product. Petroleum oil, if present, gives to the oil an odor which everyone is acquainted with. Corn oil has a very unpleasant smell, like that which comes from moldy, fermented grain. The smell is rather acrid and unpleasant. Gloss oil, if present, may be made known by its rosinous odor—gloss oil being made simply by dissolving rosin in benzine. Some painters place considerable value upon the taste and color of oils. Linseed oil has a pleasant taste which is sometimes greatly changed when adulterants are present. Raw linseed oil is generally of an amber color—with a slightly greenish tinge. An oil should not be called impure if it is slightly dark in color. The most common oil adulterants are often the same color as linseed oil. Rosin oil, petroleum oil or kerosene are added to linseed oil, the doped mixture always has a bluish-greenish color which is termed "fluorescence" by the chemist. The fluorescence materials in rosin oil and petroleum oil are probably similar in nature, and they become quite active when the above named oils are mixed with raw linseed oil. This fluorescence is most vivid when the mixtures are viewed by the reflected light of electric arc lamps such as are in common usage. The painter who finds his raw linseed oil strongly fluorescent when viewed in a long thin bottle under the reflected rays of an arc lamp, may suspect such oil of adulteration. He should then proceed to make a more positive test for the presence of oils such as rosin oil or petroleum, which might be responsible for the fluorescence noted. Fortunately, there is a great chemical difference between rosin oil and petroleum products, on the one hand, and vegetable oils such as linseed oil, on the other. The determination of the presence of the first named materials in linseed oil is comparatively simple. The test depends upon the fact that rosin oil and petroleum oil are acted upon very slightly when they are heated with caustic soda. In other words, they do not make nice clear soaps, but simply form milky emulsions. Linseed oil, on the other hand, is a great oil for making soap and when heated with caustic soda, immediately unites with the soda to form a beautiful clear soap. When linseed oil is adulterated with rosin oil or petroleum oil, the treatment of such a mixture with hot caustic soda forms a solution which does not get clear but remains milky, thus showing that the oil is not pure linseed oil. The greater the amount of adulterant, the greater the amount of emulsion that is formed.

Buy $1\frac{1}{2}$ oz. of caustic soda in lump or stick form, one quart of pure grain alcohol, two medicine droppers, three glass test tubes, and one alcohol lamp. Place the caustic soda in a porcelain-lined pan or cup and let it dissolve in one ounce and a half of cold water. The solution will get very hot. To this solution gradually add the quart of alcohol, stirring thoroughly until the mixture has become uniform. Pour into a glass bottle and keep well stoppered. In order to test an oil for its freedom from petroleum oil, rosin oil or kerosene, place ten drops of the oil in the bottom of one of the test tubes. Add a tablespoonful of the caustic soda solution. Heat the mixture over the alcohol lamp and boil it for a minute or two. Now add a half ounce of water and heat again. If the mixture gets white and milky, the oil probably contains a considerable percentage of adulterant, such as rosin oil or petroleum. If the mixture remains clear, the indications are that the oil is free from the impurities such as are noted above.

Although this test is a sure test to show the presence of non-soap making oils, such as rosin oil and kerosene, the test does not answer for vegetable oils such as corn oil or cottonseed oil. The determination of these oils can only be made by a chemist. Such oils would not be found, however, in a pure linseed oil at times when the price of linseed oil is lower than that of vegetable oils. Low grade rosin oil, petroleum residue oil and kerosene, all of which are low in price, will probably

remain the great asset of the oil doper. The presence of these oils may be ascertained by the painter himself.

A very simple test can be made to determine whether raw linseed oil contains any rosin compounds, by placing a few drops upon a white china plate and noting the color produced by the addition of one drop of acetic anhydride and one drop of concentrated sulphuric acid. A beautiful purple color is shown when rosin is present. This test should not be made on boiled oils, as resinates are occasionally used in the preparation of such products.

If time allows, the oil should be tested for its drying value, by pouring a small quantity upon a sheet of window glass placed in an upright position so that the excess will run off. On the same piece of glass there may be spread on another area a similar quantity of pure linseed oil from stock, and the test of the two oils conducted at the same time. The oil being tested should be touched every few hours to determine whether it is setting up as rapidly as the standard sample.

The purity of turpentine as purchased is a subject of quite as great importance as the purity of the linseed oil. Although petroleum spirits may be satisfactory for certain purposes, there is no reason why the painter should pay the prices of turpentine and obtain a mixture of turpentine with a high percentage of cheaper petroleum substitutes. Turpentine is often used by the painter to thin down expensive enamels and varnishes. The solvent properties of turpentine make it an ideal solvent to use for such a purpose. Petroleum spirits, on the other hand will cause curdling and precipitation if mixed with some kinds of enamels and varnishes. It is evident that the painter must have pure turpentine, when he buys it as such, although he may desire to keep a stock of other thinners on hand for certain purposes.

Like linseed oil, turpentine is a thinner which requires the attention of a chemist when it is to be most carefully examined for impurities. There is, however, a quick test which may be used to find out whether the product bought is fairly pure.

The test is made by placing a small quantity of turpentine (about $\frac{1}{3}$ of an ounce) in a test tube, and adding an equal quantity of aniline oil. Pure turpentine and aniline oil will mix and form a clear solution. If benzine, coal oil, or other petroleum products are present, the liquid will not be clear at first, and upon settling the petroleum will rise to the top and float upon the aniline oil. This is due to the insolubility of petroleum in aniline oil. This test should be made in a warm room.

If the sample of turpentine being tested does not give a clear solution with aniline oil, it may be regarded as suspicious.—J. Wynne, in Decorator.

LUMBANG OILS IN THE PACIFIC ISLANDS

J. F. Boomer, Manila, says investigations have proved that there is very little if any difference between the kukui nut of Hawaii and the lumbang nuts, *Aleurites moluccana* and *Aleurites triloba*, found in the Philippines. Kukui-nut oil is a valuable Hawaiian product and is in demand in the paint and varnish trade. It has been shipped to the United States from various Pacific islands for the last 75 years.

The kukui-nut oil of Hawaii, like the lumbang oil of the Philippines, has very pronounced drying properties and is said to be suitable for all purposes for which linseed oil is used. The kukui-nut press cake is rich in nitrogen, phosphoric acid, and potash, and is highly prized as a fertilizer. This is also true of the lumbang cake of the Philippines. There seems to be some difference of expert opinion as to the value of these cakes as a fodder, but most feeders consider them poisonous. The oils are generally considered as unfit for human consumption on account of their pronounced purgative properties.

An oil is made in the Philippines from the nuts of *Aleurites trisnerma*, locally called "lumbang banucalad," and the asser-

tion is made that it is practically identical with the well known Chinese tung oil.

(Considerable confusion has been caused by the great number of names applies to the oil made from several tropical species of Aleurites, notably *A. moluccana* and *A. triloba*. These trees are widely scattered over the tropics of the eastern hemisphere, which accounts for the number of local names applied to them. Among other names are the following: Bankul, Belgaum walnut, biao, candleberry, candlenut, country walnut, eboe, Indian walnut, kekuna, kekun, and Spanish walnut. It should be borne in mind that these tropical species are not the same as the temperate Chinese species, *Aleurites fardii* and *A. cordata*, from which tung oil is made.)

HINTS AS TO PLAIN LETTER SHADING, AND WHERE TO PLACE IT

Judging from appearances, there would seem to be no reason for what we commonly call the shading of letters, other than make an additional show of color on the work. It is well for the general run of letterers, that for the most part the people they work for seem to also so regard it, and it is evident that a majority of letterers never have considered the why or the wherefore of shading in an intelligent way. Letter shading is not, and could not, be done in accordance with the strict laws of perspective where all lines converge to one point, because each must be given a perspective of its own, in order to create symmetry and beauty, yet at the very outset of his career, the learner should familiarize himself somewhat with perspective, especially linear perspective, if only in order to get a realizing sense of the purpose for which shading is, or rather ought to be, done.

Many have an idea that color as shading can be stuck on just anywhere, and with but little regard to the shape of the letter itself, but that is not so. Perhaps the simplest way to begin to realize what shading should be is to imagine each letter of the word you have painted, to be cut out of wood about one inch thick, and glued to the surface; if they were so, it can easily be seen that from whatever side the light would come, the shadows would be on the opposite sides, and that the shadow shapes to be painted would be determined partly by the form of the letters, and partly by the direction from which they are lighted, also that a broad diffusive light—as daylight—would give each letter an individual shade, or perspective of its own.

Lettering is mostly shaded at the right and underneath, which supposes that the light strikes the letters from upwards and the left. We sometimes see shading to the left and upwards, and there are places where it seems to go all right that way, as on the concave lower sides of street cars, when the job is well and understandingly done.

There is a simple method of determining where shading ought to be put which may be very useful to a learner, and any one can put it to the test with very little trouble. Draw on thin cardboard, say, a 3-inch letter—any letter—cut it out cleanly, so you can use it as a pattern to mark around with a pencil. Make the outline of it on a clean piece of paper.

Now shift your pattern, say, $\frac{3}{8}$ of an inch to the right, and the same distance below, lightly pencil around outlines to right and bottom, and you will find that, with the exception of joining corners, you have marked just about where your shading ought to go, provided that is the width of shade you want to make.

Not all lettering should be shaded. The shading that will make a painted letter stand out in solid relief, or appear sunken as though cut out, is real art work, and to create the effect successfully requires much skill and long practice. A misplaced shadow will destroy any otherwise artistic effect you may have succeeded in producing.

When you start shading, never forget where the light comes from, and you will probably not go far wrong.

RED PAINT

Red running parts, and panels on certain lines of carriages and wagons painted in various shades of red, are in by far greater favor than any other color.

Liverymen say that carriages with red running parts rent easier than carriages painted in other colors.

Most of the reds have the property of furnishing a glow of color in the winter and a neutral brilliancy of effect in summer. There is a gaiety in the brighter reds that conduces to pleasure. Red is a strong color in its capacity for concealing surface defects. Surfaces that would challenge attention if coated up with blue or green or black, pass without arousing complaint when tricked out in red.

From the standpoint of the vehicle user, red is a color comparatively easy to take care of, shining on under conditions of service sufficient to completely upset most other pigments.

There is said to be more than a hundred new tones of reds introduced to the trade, although it is fair to infer that many of these new comers are merely a shade or tone removed from a lot of old friends of the family.

With these reds, as with not a few other fine colors, much depends for their richest display upon their preparation and application to the surface. A majority of them need a good strong ground color built up with plenty of resources. Then a coat of the final red, mixed to dry flat, but not flaky, is applied. Next heat up some of the color in turpentine, and add enough rubbing varnish to transform the color to a glaze preparation, flowing this upon the surface quite with the same plentousness and freedom that would be observed in applying the clear rubbing varnish.

This coat when dry may be lightly surfaced with No. 00 pumice stone flour and water. The next coat of rubbing varnish should carry enough of the red to maintain the purity of the color and to give it an increased depth of lustre.

For red effects upon panels the lakes are annually becoming more popular.

English scarlet lake is best developed over a ground of vermilion, Munch lake over a deep wine color, Chatemic lake over a deep carmine ground, and crimson, either English or American, over a Flamingo or Aurora or a similar full flush red. All these lakes depend for the brilliancy and rare lustre upon the ground color and the surface preparation for these colors. Bring these colors up very close to the lakes themselves. Then apply a coat of the flat lake thinned with turpentine and bound with a few drops of rubbing varnish. Then make a glaze by mixing in rubbing varnish, using $\frac{3}{4}$ oz. of color to each pint of varnish.

WILLEY'S COLORS

There has come to hand from C. A. Willey Co. in Hunter's Point, New York City, a box of samples of "standard carriage colors." These paste colors are really fine. If painters who receive this little box of samples, just like playing cards in a box, shall fall to playing "solitaire" with them, as we did, then would spend time most usefully in trying out harmonies and contrasts. It is a fascinating kind of solitaire.

HE "TOLD YOU SO"

The Deeds & Jordan Buggy Co., Nashville, Tenn., reports continued heavy demand for buggies, especially in the pony buggy line. "I told you, two years ago, that the pendulum was swinging back," said President J. B. Deeds. "It has more than swung back. Many people who bought automobiles have been comparing the cost of upkeep and the number of miles secured and have found that there's only one economical method of overland transportation—the horse and buggy. The country's waking up."

Wood-Working Shop

AMERICAN WHEELS FOR CEYLON RICKSHAWS

Consul Henry D. Baker, Bombay, writes: American wire wheels with rubber tires are beginning to compete seriously with Japanese wooden wheels for use on the better class of rickshaws in Ceylon. They are sold at Colombo for about \$50 per pair, equipped with $\frac{7}{8}$ -inch tires, circumference of the wheels being about 42 inches. As it is obvious that wire wheels on rickshaws are becoming popular, some Japanese firms have been sending wire wheel samples to Colombo, at cheap prices, but of such inferior quality that dealers in the best rickshaws have not given them any serious consideration. The American wheels arrive neatly packed in boxes, whereas the wooden Japanese wheels, which are merely bound up in straw covering, often arrive with wooden spokes. The wire wheels have the advantage over the wooden wheels not only in neatness of appearance, but also in creaking less on specially hot days and in creating less unpleasant vibration. For persons in Ceylon who have their own private rickshaws, and especially for ladies who value smartness in appearance, the American wire wheels are rapidly gaining in favor. For the ordinary coolie, however, who draws a rickshaw for hire, the American wire wheels are too expensive, and for this class of trade it is probable that Japanese wooden wheels, rubber tired, and selling for about \$28 per pair, will continue to hold the market.

Up to about five years ago there were no rubber-tired rickshaws in Ceylon, but at present nearly all those used are rubber tired, and the rickshaw coolies find it very difficult to get patronage unless their rickshaws have such tires. The tires are imported chiefly from England, being bought wholesale by the thousand feet, most of them being seven-eighths of an inch thick. They retail in Colombo for about \$1.90 per pound, which is twice the wholesale price paid for them by the dealers, who, however, pay the expense of putting them on the wheels, which work is done by machines.

A few years ago a local rickshaw firm imported a large number of American wooden wheels, but while the woodwork was quite satisfactory, yet the ball bearings, axles, and other metal parts gave considerable trouble and were unworkable within a very short time; on the other hand, Japanese wooden wheels, constructed much more simply, and crude in appearance, have had the reputation of running for as long as three years at an average of 30 miles a day without showing serious deterioration. At present all of the wooden wheels used on Ceylon rickshaws are of Japanese manufacture. Their mechanical details can easily be comprehended by the coolies. They have plain straight axles and simple cast-iron bushes with a nut on one side of the bush and leather washers between. All these parts are easy of readjustment and replacement, and if lost or broken are not expensive to renew. A new axle will not cost over \$2.50 and a new bush not over 36 cents.

Rickshaw bodies used in Ceylon come almost entirely from Japan, very few being made locally. They are imported from Japan, two together, encased in heavy strong matting. They are well lacquered and nearly always black in color, though sometimes red. No brakes are attached, but brakes are put on in Colombo when the rickshaws are intended for mountainous country. Generally speaking, the Japanese rickshaw meets satisfactorily two essentials, namely, that it be cheap in price, and that it will be also so light and well balanced that it is easy to pull. It is a curious fact that the rickshaw coolie can run faster drawing a rickshaw than he can run alone, because the poles are so well balanced in a well-made vehicle that they

give him support, enabling him to continue for hours his treadmill-like run.

An ordinary Japanese rickshaw with flat iron-rimmed wheels of the cheapest make, with lamps, but without bells, sells in Colombo for about \$33; the prices go upward with increased strength and style, and especially when the rickshaws are built for use on up-country mountainous roads, in which case they must be equipped with stronger axles, broader wheel rims, etc. The addition of rubber tires adds about \$18 to the cost. The finest rickshaws sold in Ceylon, known as the Geisha carriages, cost about \$85 and are much used by ladies. They have handsomely finished bodies, seats, and arm rests, are upholstered in leather, have good hood coverings, waterproof aprons, and detachable side wings, and are well sprung and fitted with American ball-bearing, rubber-tired wire wheels, plated hubs, etc. None of the rickshaws used in Ceylon can seat more than one person.

There are probably at an approximate average about 150 rickshaws sold in Colombo every month, the business being in the hands of about ten leading dealers who cater for the entire trade of Ceylon, as well as taking many orders from southern India. On rickshaw bodies their profits are said to be about 12 per cent., on wheels about 20 per cent., and on rubber tires up to 100 per cent. There is also a profitable business in rickshaw accessories, parts, and fittings, including especially mats, lamps, and bells, all of which are supplied from England. All rickshaws in Ceylon are obliged to be equipped with lamps and bells. The lamps are mostly oil burning, selling for about \$1.60 per pair, although a few use carbide and are more expensive. The bells, which cost about \$2 apiece, have loud double chimes and are worked with springs. American bells have been tried here, but it is complained that after a certain amount of bad weather they cease to give forth any effective noise.

Shrewdness of Coolies in Purchasing Rickshaws

The rickshaw coolies of Ceylon usually buy their rickshaws from local dealers on an instalment plan, paying about \$5 per month, the dealers by legal agreement maintaining a lien on the rickshaw until the debt is entirely paid. Local dealers in rickshaws state that the coolie is a most particular person to deal with and often spends hours in the observation of a particular vehicle before making up his mind to purchase it. Sometimes a faint, almost unnoticeable scratch on the lacquer is sufficient to create an adverse judgment. When well-to-do persons, employing coolies for their private rickshaws, desire to purchase new rickshaws, it is always found to be the best policy to leave the selection to the coolie himself, so that his own fancies and prejudices may be satisfied; otherwise there is likely to be constant grumbling, and the coolie whenever careless or negligent will lay the blame on his master's choice of the rickshaw.

MANIPULATING GLUE

Do not employ any more heat in melting glue than is required to reduce the soaked mass to the proper working consistency. Under no circumstances should hot, or even warm, water be poured upon dry glue. The heat, so far from facilitating the softening, actually retards it, if not preventing it altogether.

Where steam is not available for melting the glue, and the direct heat of gas or oil has to be used, the melting pot must be jacketed, as otherwise the solution will burn and char. The outer jacket should be filled with water, which, when brought to boil, will impart sufficient heat to the water of the

inner vessel to melt the glue. Once the water in the outer jacket is at the boil, the heat should be withdrawn. The facility with which the glue melts will depend upon its proper softening. If this detail is attended to, there should be no difficulty in obtaining a uniform melt at the minimum temperature.

When soaking the glue, see that the pieces are well covered with water; it is necessary that they be stirred in the water as it is added, to insure uniform wetting. If this precaution is neglected, pieces will adhere to each other and the center of such masses will be quite hard, even though the exterior is well soaked. These partially soaked masses required protracted heating at the expense of the whole solution, in order that they shall melt.

The trouble with the average small user of glue is that a few pounds will last a long time, and the glue solution is cooked time and again. Heating glue has the drawback of pulling down its strength. We cannot use the glue in the dry form, as it is in the barrel. We must change its nature and make it fluid by exposing it to the combined influences of heat and water—and the use of these two agencies costs something of the power in the glue. Heat damage is in exact proportion to the degrees of heat applied and to the length of time heated. If heat damages the glue, it is absolutely necessary to employ no more heat in melting glue than is required to reduce the soaked mass to the proper working consistency.

Bone glue does not possess the characteristics essential to the proper performance of this work. It does not have the binding quality nor the lasting quality of hide glue. Many bone glues will absorb moisture before they are put into the work at all, and they will, in damp weather or in a damp climate, absorb a certain amount of moisture, even after having been put into the work. Constant climatic action of this kind will so weaken the glue in a comparatively short time that the joints will open and the piece of woodwork need repairing in its entirety, or be of no value whatsoever.

Do not buy glue from hardware dealers or paint and glass houses; get it direct from the manufacturer. Or, if you require but a small quantity, buy it from some furniture manufacturer. By all means, use pure hide stock for wood work.

TO KEEP DIRT OUT OF THE OIL CAN

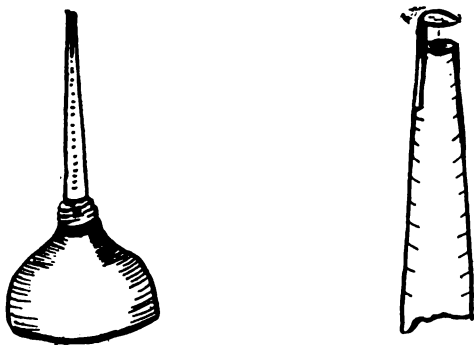

Solder a piece of tin or wire on the spout as shown in the illustration. In use this will push any dirt in advance of the oil spout, and allow a free flow of oil and prevent dirt from entering the small opening that is so easily clogged as usually used.

PREPARING GLUE

Glue cannot be prepared by any fixed rules, for the reason that there are so many different grades. Again, glues differ in the relative proportion of water and glue. For instance, a certain kind of glue taking two parts of water for every part of glue would give unsatisfactory results if three parts of water were added. Some grades require three parts of water, while others can stand but $1\frac{1}{4}$ or $1\frac{1}{2}$ parts per part of glue. The viscosity of the glue solution usually indicates the relative pro-

portions of water and glue. This test requires experience. Have the manufacturer from whom you are buying the glue inform you what proportions will give most efficient results, then weigh the water and glue and do not mix otherwise than directed.

After the glue has been properly soaked, it must be melted by the application of heat. This is the most important part of the process. The words most important are used advisedly. It is safe to say that most of the damage done to glue is done in the melting process. There are all kinds of ways of melting glue, but many of them absolutely ruin glue for practical work.

NUTTER READY FOR BUSINESS

As announced in a previous issue the Nutter Gearwood Co., manufacturers of carriage, buggy and spring wagon gearwoods, was organized at Seymour, Ind. They are busy at work now filling orders. The officers of the company are as follows: Alonzo Nutter, president and general manager; Nathan Kauffman, vice-president, and C. B. Davis, secretary and treasurer. The company was organized by Mr. Nutter, who is well known to the vehicle industry, having been engaged in this line of work for over 35 years. He formerly was general manager of the Zanesville Gearwood Co., Zanesville, O., and is a man thoroughly experienced in the gearwood manufacturing industry.

The factory at Seymour is 200 x 50 feet, two stories, in which has been installed the most modern machinery; has a capacity of 150,000 sets of gearwoods annually, with unexcelled shipping facilities, Baltimore & Ohio, Pennsylvania and Southern Railroad, they are in good position to take care of business. They are also accessible to the lumber regions of southern Indiana and Kentucky.

SOUTHERN WAGON MANUFACTURERS MEET

A meeting of southern wagon manufacturers was held recently at Washington, N. C., representatives of all the prominent concerns being present. The topics of discussion were the manufacturing cost of wagons and standardization of styles and sizes. Among the firms sending representatives to the meeting were: Auburn Wagon Co., Martinsburg, W. Va.; Thornhill Wagon Co., Lynchburg, Va.; Kentucky Wagon Co., Louisville, Ky.; White Hickory Wagon Co., Atlanta, Ga.; C. H. Russell & Co., Clarksville, Va.; Florence Wagon Co., Florence, Ala.; Chattanooga Wagon Co., Chattanooga, Tenn.; Hackney Wagon Co., Wilson, N. C.; Columbia Wagon Co., Columbia, Pa.

HARNESS DEALERS TO KANSAS CITY IN 1915

James Chambers, of Troy, N. Y., was reelected president of the National Harness Manufacturers' association at the 28th annual convention, which closed at Minneapolis, July 22.

Other officers chosen were: Vice-president, Louis J. Hack, Cleveland, O.; secretary, G. M. Scherz, Cincinnati, O.; treasurer, D. A. Hopkins, Grinnell, Ia.; executive committee, James S. Jackson, Glen Falls, N. Y.; F. J. Magin, Albany, N. Y.; Joseph Tynan, Cohoes, N. Y.; Charles S. Gibbs, Rochester, N. Y.; Conrad Hartung, Schenectady, N. Y.

The convention decided to meet in Kansas City, Mo., in 1915. Between 500 and 600 harness dealers were in attendance.

MUNICIPAL BUS LINE

The city of Pittsburgh is considering the proposal that it establish a municipal motor bus line for the accommodation of the public in the city parks. The parks cover great areas that are not accessible by trolley or other forms of transportation. A resolution calling upon automobile firms to submit some suggestions to the council was affirmatively passed in the committee on parks and libraries.

Smith Shop

ABOUT DROP FORGING

The history of drop forging dates back some 50 years or more. The early history of drop forging shows that more or less depended on the skill of the smith. He was obliged to work out the material almost to the desired shape by hand, then with the aid of portable tools which were used in conjunction with the power and steam hammer the forgings were finished to uniform size. With the development of machinery along other lines, it was only natural that the same progress should affect the forging business. And so it has, for drop forging has developed to a greater extent and in its simplicity even outstripped every other mechanical development of today.

While the railroad blacksmith deserves the credit for the original idea of drop forging, the sewing machine, shoe machinery, harvester machinery and vehicle industries have been more instrumental than any other agencies in bringing stamp or drop forging to its present simplicity. From the fact that drop forging is purely mechanical (thus eliminating the skill and artanship formerly required by the smith), the word simplicity clearly signifies the methods used, which effect a wonderful reduction in the cost of production (about 40 and in some cases 50 to 1).

Forgings can be made in greater variety and those that were most difficult or even impossible to finish over the anvil are done with apparent ease under the drop hammer. There seems to be no limit to design; they make any shape from a cocked hat to a fountain pen; and the best feature of all is that the work is done more accurately; imparting a finish to every detail.

Knocking down is a term applied to the preparing or shaping of the work before it enters the dies of the drop hammer and is an operation in itself.

Square stock is used invariably for all classes of work, it being more practical than any other shape for drop forging.

For some forgings it may be necessary to work it down diagonally and in others from the flat surface, however it answers the purpose in all cases.

No distinction is made as to grade of material; stamp forgings being made from all grades ranging from common iron to chrome nickel steel. A great amount of this work requires from one to four operations or "steps" as they are called sometimes.

That good results in drop forging depend a great deal on the location and design of the building intended for this class of work is beyond doubt, for although the men do earn exceptionally high wages they work piece-work, and owing to the nature of the work, which is so extremely hot the average man can scarcely endure it, and unless the surrounding conditions are of the very best, it is very difficult to retain the services of competent help; and a good heater is as essential in producing the goods as is the hammer-man himself.

Therefore the location should be ideal. The highest spot should always be selected for this building where it would have the greatest access possible to fresh air and by all means a building by itself. The design should be such that during the summer months the sides and ends may be entirely opened—ventilation being as important as light. Steel framework throughout, with detachable sliding doors to correspond, is best suited for this purpose and it should be at least 20 feet high from floor to girders, with a pitched roof. The building should be long and narrow, not over 70 feet wide, which will allow ample space for two rows of hammers and furnaces as well. The dies being very heavy, an overhead track system should

be provided, both in front of the hammers for the transportation of dies from the die room to the forge shop and vice versa.

A ram should be used for driving keys in and out of the hammer, and this track system could be used to great advantage in conveying it to and from the hammers and also for swinging it. The layout and equipment is also an important factor in the good results obtained in these plants.

A great many forgings go through the annealing process and a great many that happen to be scaly go to acid vats where scales and dirt are loosened. Afterwards being turned in the rattler they are cleaned and polished.

As all hammer dies must be annealed and tempered before they are fit for service, special furnaces and tanks should be provided for these purposes and care taken to see that plenty of space is allowed for the handy manipulation of this work.

The Dies

In direct relation to the forge shop is the die sinking department. The making of drop forge dies, together with the hardening process through which they are put, is a trade in itself, though closely allied to tool and die making as understood in the big shops. Each branch of shop work presents its individual problems; and a tool and die maker though skilled in other lines can not go into a forging shop and make drop forge dies without special instructions and training.

In drop forge die work, as in other kinds of tool work, there are various grades of accuracy and finish required. Some forgings must come from the hammer practically finished to size, while others are made large enough to allow considerable machining. Where only a few pieces of a rough nature are required, little skill is needed in the making or maintenance of the dies, but where small, accurate parts are to be made in large quantities, special tools for both hand and machine use and trained skillful die makers are needed, as well as a careful selection of the steel used.

Steel cast into blocks is not suitable for this work, as flaws or blowholes are likely to develop where least desired or expected, so as a general rule forged blocks of open hearth steel are used. These blocks are either purchased ready forged in various sizes from the steel manufacturers or are forged in the shop where they are used; the former plan being the usual one.

A rough estimate as to the life of a drop forging die used for medium sized work on bessemer steel was given by a foreman of long experience as about 40,000 pieces. Some dies might be broken immediately when put in operation, while others might stand for 100 pieces or even more.

The dies used in the trimming or stripping press are made of cast iron; the cutting edges of the bottom dies being inlaid with tempered cast-steel plates about one inch thick and from three to five inches wide. A clearance is left on the cutting edges to allow the forging to drop through to a convenient opening in the bottom of the dies where the forging may be slipped out. Most forgings require two or more strippings and must be handled very quickly, for if allowed to remain in the dies too long the temper is drawn in the steel plates, rendering them unfit for service. The same caution is applicable to the steel dies of the hammer.

Gray iron castings are used successfully for certain classes of light forgings where the impressions are not too deep or definite and especially for short orders. They are much cheaper; and as the impression can be molded in the die very little machine work is required; but the face and impression itself should be absolutely smooth, and sharp corners eliminated wherever possible. A great deal of work can be performed

with cast-iron dies if practically designed and kept properly adjusted. In fact, dies of any material to be used for stamp forging should be kept perfectly adjusted with the key to the dovetail slot on the base block of the hammer; not only to insure the life of the dies, but to insure a perfect forging.

Drop forging dies are made of 0.45 to 0.60 carbon steel and are usually from five to eight inches thick. The dies are marked "T" and "B" (top and bottom), to prevent their getting mixed in the laying out. The front and left hand sides are squared up, and from these sides the center lines of the impressions are laid out and the dies set up when ready for use. The edge or breaking down impression is on the right hand side of the die. It is used for breaking down the rough heated stock into something like the required shape before it goes into the finishing die. The heaviest part of the forging is always nearest the front. In deep dies, shapes which show parallel sides on the drawing are given from five to seven degrees taper on each side to prevent the forging from sticking in the die. For machining, 1/32 inch is usually allowed; and for shrinkage, 0.012 to 0.015 per inch. When the dies are finished a specimen casting of lead is made in them to ascertain whether or not they will give the desired result.

The edger or breaking down form on the right of the die is made from 1/16 to 3/16 inch smaller than the horizontal cross section of the forging and has no abrupt shoulders or curves. The idea is to get the heated stock smaller in width than the finishing impression; so that the bottom of the impression strikes the stock first and spreads it to the sides filling the dies. Cast-iron dies are also used for breaking down heavy work.

The flash, which is a recess 0.015 to 0.025 inch in depth and about 7/8 inch wide, milled around each impression, allows the surplus stock to escape from the die. This surplus is afterwards trimmed off in the trimming dies. The top die also has a groove about 1/16 inch in depth milled around the impression, 1/4 inch from the edge. The gate for clearing the stock tapers gradually towards the front from the impression, so as not to weaken the die at that point.

In dies for making small forgings in large quantities there are several impressions sunk, one of which is used for a rougher and should be about 1/32 inch narrower and deeper than the finishing impression. Some dies have to be interlocked when difficult shapes are to be forged; that is, the faces have to be shaped to suit the offset in the forging. Care must be taken to have the interlocking parts high enough so that the dies will not glance off when striking the stock and make an imperfect forging.

When the faces of the dies are curved, special cutters are made for surfacing and flashing. As a guide for machine curved impressions some mechanics transfer the lines to the side of the die blank and lay out the curve there, then clamp a surface gauge on the profiling machine, and with the needle set to the face of the cutter work out the stock by following the lines with the needle point. Dies for forging gears or similar work are finished with a broach having the teeth machined in it, which is then driven into the die.—American Blacksmith.

PROTECTING THE EYES FROM ULTRAVIOLET RAYS

A remarkable series of tests has recently been made to determine the best type of glass for the protection of the eyes from the injurious effect of ultraviolet rays in the industries. Industrial processes involving high temperatures and excessive amounts of light rays of extremely short wave lengths occasion eye troubles of more or less seriousness, and the use of clear or smoked glasses does not afford relief. Photometric and spectrometric tests resulted in the adoption of a yellow-green glass as a standard, as it appears that such glass is opaque to short wave rays of the injurious class, while colors are distorted less by it than any other tint or combination. Goggles equipped

with this yellow-green glass have been prepared for use in oxyacetylene welding, in the steel and iron industry, and in glass blowing.

TERMS APPLYING TO FILES

Back—A term commonly used to describe the convex side of half-rounds, cabinets, pitsaws and other files of similar cross-sectional shape.

Bellied—A term used to describe a file having a fullness in the center.

Blank—A term used to describe files in any process of manufacture before being cut.

Blunt—A term applied in describing files which preserve their sectional shape throughout from point to tang.

Equaling—A term applied to describe a blunt file upon which is produced an exceedingly slight belly or curvature, extending from point to tang, the file apparently remaining blunt.

Filing Block—A piece of hard, close-grained wood, having grooves of varying sizes upon one or more of its sides. It is usually attached to the work bench by a small chain, and, when grasped in the jaws of the vise, is particularly useful in holding small rods, wires or pins, which are to be filed; also in filing small flat pieces, which are held to the block by pins, or by letting in.

Float—The coarser grades of single cut files are not infrequently called floats, when cut for the plumber's use or for use upon soft metals or wood.

Hopped—A term known among the file makers, and used to represent a very coarse or open spacing of the teeth (sometimes exceeding 1/2 inch) mostly applied to the backs of half-rounds and to the edges of quadrangular sections.

Middle Cut—A term used to designate the cut of a file when it is of a grade of coarseness between the rough and bastard. It is but little used in this country.

Over Cut—A term used to describe the first series of teeth on a double cut file.

Re-cut or Re-cutting—The work over of old or worn out files by the several processes of annealing, grinding out the old teeth, re-cutting, hardening, etc., and thus again preparing them for use. This operation is sometimes repeated two and even three times, but the economy of re-cutting at all is very much questioned, and the practice is done away with in most of the best appointed shops of the present day.

Safe Edge (or Side)—Terms used to denote that a file has one or more of its edges or sides smooth or uncut, that it may be presented to the work without injury to that portion which does not require to be filed.

HEIGHT OF A VISE

For filing in a vise the work should be held as rigidly as possible and the vise jaws should be placed so as to be level with the elbow of the workman, which will be found to range from 40 to 44 inches from the floor—therefore, 42 inches may be considered as an average height, best suited for all heights of workmen, when the vise is to be permanently fixed. This position enables the workman to get the full, free swing of his arms from the shoulder; the separate movement of the wrist and elbow should be done away with as much as possible.

If the work to be filed is small and delicate, requiring simply a movement of the arms, or of one hand and arm alone, the vise should be higher, not only in order that the workman may more closely scrutinize the work but that he may be able to stand more erect.

If the work to be filed is heavy and massive, requiring great muscular effort, its surface should be below the elbow joint, as the operator stands further from his work with his feet separated from 10 to 30 inches, one in advance of the other, and his knees somewhat bent, thus lowering his stature; besides, in this class of work, it is desirable to throw the weight of the

body upon the file to make it penetrate, and thus, with a comparative fixedness of the arms, to depend largely upon the momentum of the body to shove the file.

MISUSE OF TOOLS

One of the most destructive customs is that of loosely throwing files, fine and coarse, small and large, into a drawer filled with cold chisels, hammers, turning tools, etc., and then throwing the chisels, hammers and other tools on to the files.

When we consider how small a portion of the points of the teeth is worn off by extreme wear when the file is properly used, and that to effectually dull them for some kinds of work requires but slight knocking upon a hard substance, it will be easily seen that the evils of this habit should be more carefully considered by the master mechanic, and suitable provision made to avoid its destructive tendencies.

STARTING A TAP IN A PULLEY HUB

It is not an easy matter to start a short tap in a hole drilled in the hub of a small pulley. Having a number of these to tap for setscrews, I devised the tap starter shown. It consists

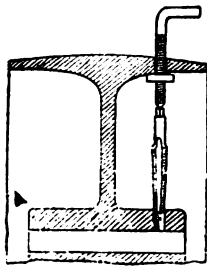

of an ordinary bolt, of a size to pass through the drilled hole in the pulley face, and with its nut placed on the inner surface. If the bolt does not have a square or octagon head, it can be turned at right angles, as shown, to make a handle. The tap can be easily started straight with the bolt.

NEW COMPOUND FOR BLACKENING METALS

For imparting a lasting black coating of mat luster to parts made of any of the reddish varieties of brass, to copper, gun metal and most bronzes, among which phosphor bronze and manganese bronze, *Elektrochemische Zeitschrift* recommends to dissolve 5 kilograms of caustic hydrate of soda in 100 liters of water, bringing the mixture gradually to the boiling point of water, 100 degrees centigrade, and then to add 1 kilogram of powdered persulphate of potash. The article is suspended in the hot solution for 7 to 10 minutes, is then rinsed in clean water and dried in sawdust.

In the case of aluminum-bronze or kindred light bronzes, the lye must be concentrated; that is, 10 kilograms of caustic hydrate of soda must be dissolved in 10 liters of water and the 1 kilogram of persulphate of potash is added to this smaller quantity.

AMERICAN AUTOMOBILES IN BURMA

Consul M. K. Moorhead, Rangoon, India, says American automobiles have become firmly established in Burma. During the year ended March 31, 1914, 149 automobiles valued at \$120,350, as against only 57 cars valued at \$49,740, during the preceding year, were imported from the United States. There were also imported during the fiscal year ended March 31, 1914, 14 American commercial motor cars, valued at \$19,080. These light commercial vehicles are used by the Rangoon post office for delivering mail to the branch offices; by the Burma railways for their parcel deliveries, and by a few of the retail stores.

The imports from the United Kingdom were 106 automobiles

valued at \$141,210, and 233 motorcycles, valued at \$52,640, and \$62,190 of parts. All other countries furnished only 11 automobiles valued at \$13,480 and 10 motorcycles, valued at \$2,110.

These statistics, however, do not give full credit to imports from the United States. Quite a number of American automobiles are purchased in England and put down as imports therefrom. There were also about 25 motorcycles shipped into Burma from the London agency of a well known American manufacturer of motorcycles.

In April, 1914, G. MacKenzie & Co. established a motor taxicab system in Rangoon; 25 four-passenger American cars (Hupmobile) were placed on the streets; 25 more of these cars are on order. The rate is 16 cents a mile. If successful, 50 more American cars will be needed.

On account of the bad roads in Burma, touring is impossible. The streets of Rangoon, while greatly improved during the past year, are still, except in the business section, rough and badly paved. The expensive touring car has very little demand. Twenty horsepower four cylinder, four or five passenger cars are the most popular, selling from \$800 to \$2,500 retail. Very few runabouts are used. Cars with left-hand steering and control can not be sold in Burma.

Recently, however, a few British-made cycle cars were imported. The demand for this type of car is not very great at present, but may increase as the cars become better known.

Automobiles and component parts imported into Burma are dutiable at 5 per cent. ad valorem. Motor cars designed to carry goods are free.

An amended list of dealers is forwarded (and may be had from the Bureau of Foreign and Domestic Commerce and its branch offices.)

SPANISH CONSULAR AND TRADE REPORT

Paints and Varnishes

From a report received directly from the representative of an American manufacturer of paints and varnishes who has traveled in Spain it is learned that an increased volume of business in these lines can be had. The usual intensive campaign will have to be made if the United States is to get its full share of the varnish trade, which is now largely in the hands of Belgium, France, and Great Britain. The same is true of colors in oil and water. Colors figure in the latest statistics for imports to the value of \$643,728 and varnishes \$246,485. Each of these specialties shows a steady normal increase in the volume of imports each year, and it is well within the power of the American manufacturer to have a more generous share of the trade.

Automobiles and Motors

Sales of automobiles, motor boats, and gasoline motors can be largely increased in Spain within the next few years. Automobiles have been largely imported from France in the past, and with about 2,000 registered in Barcelona and Madrid and many scattered through the other large cities they are in great demand. Regarding the motor car as a utility vehicle rather than a mere touring pleasure car there are great possibilities of future increases of American sales. A half dozen of the well known American makes are already represented in Spain, and as the American car is recognized as a trim, light weight, but heavily engined car it compares more than favorably with the highly refined, high-speed vehicles. The competition is chiefly with French cars, the Hispano-Suiza of Spanish make, and to a smaller extent those of Germany. Great Britain, the United States, and Belgium sent practically all the other in 1913, ranking in the order named, but recent information indicates a big gain already by at least two American manufacturers over last year. The fully equipped, self-starting, electric-lighted automobile of ample but not excessive power fits the needs of this market; but attention must be paid to such details as the use of metric-system measurements for spark plug connections, the boring of valve stem holes to the size of European valve stems,

and the making of rims in true millimeter and not in inch sizes. The small automobile of the cycle-car class would seem to have no future here, for the service it renders is much better performed by the motor cycle, of which at least two American makes are well known here, besides those of Great Britain and Belgium.

There is a demand for a good low-priced American car, and two well known American makes are both doing well here, but nothing below the real automobile classification would seem to have any chance of satisfactory sales in Spain, where the automobile is something more than a toy or a sporting vehicle.

Customs regulations favor the importation of chassis without bodies, but the fully equipped American automobile can usually compete on the ground of price. The sum total of ocean freight, crating, insurance, rehandling at the docks, and customs duties makes a heavy charge, and the American automobile must sell here at 50 to 80 per cent. over its American price. A saving can be made by uncrating the shipments at Marseille or Gibraltar and forwarding them into Spain on flat cars, or by sea unboxed, but this saving should properly be considered a perquisite of the agent as an extra encouragement for him to push the American automobile, rather than a reason for not giving him the best possible terms. Automobiles exported from all countries to Spain are subject to about the same expense except those shipped in by a comparatively short rail haul and avoiding a charge approximating \$200 for ocean freight to begin with, and perhaps another \$40 or \$50 for crating.

If a sufficient business with Spain would warrant, it would pay the American manufacturer to ship all chassis, bodies, accessories, and parts in knocked-down form as near as possible, but this would necessitate a transshipment at some near-by Mediterranean port in France, where a transfer might be made to a coasting steamer or to rail without the necessity of crating. It would all depend upon the volume of business to be done, but a real saving and a consequent reduction in price could be made by some such procedure.

Gasoline consumption should obviously be kept as low as possible, and this is a feature which seriously affects the status of the American car. (The cost of gasoline in Spain is about 400 per cent. higher than in the U. S.—Ed.)

NEW WINDSCREEN FITTING

A new design of windscreen, named "The Rex," has been introduced in London, and it has a number of features. The device can be applied to all the purposes for which a windscreen is used, irrespective of the size of the car or the position of the screen. In the enclosed drive car at the edges of the D-shaped glasses in the corners there is no pillar or metal support to carry the glass or support the roof. The framework of the screen fits closely into the woodwork, and leaves no gap whenever either glass is moved to any position, a special design of metal edge being used. This insures that the screen closes down on the quarter glass and that there is no rattling or liability to crack either glass.

A landaulet canopy is supported in the usual manner by the side rods, and these carry the windscreen, which may be in two movable parts or in one moving part, and a fixed bottom glass adapted to suit the torpedo-shaped dash. The inside-drive window has a method of attaching the two parts of the screen to the side pillars by plates and screws, so that there is facility in fixing and security.

The principle upon which the screen frame is constructed and works is novel. There are two points always to be observed in a windscreen—facility of operation and rigidity when in any position with the minimum of liability to shake. Apparently, there is but a brass or nickel tube carrying the glass frame, and a thumbscrew conveniently placed, the slackening and tightening of which enables the frame to move, and secures it when moved. The manner of building up the screen is as follows: Suitable lengths of the D-shaped tubes are acetylene welded

to the appropriate cast metal top, with its special fitting for securing the limousine front or the extension top of the cabriolet or Cape hood. To this fitting is also welded, by the acetylene process, a specially made steel tube, perfectly smooth on its two surfaces. This tube is not quite half the length of the windscreen, and has a saw-cut some 2 inches in length, running along the inner end, dividing it in two halves. As there are two supports, so there are two tubes wherever there is a moving screen. As these tubes are fixed at one end they are rigid, and over them is the tube carrying the actual glass frame. This is the exact length of the glass frame, and it is made a sliding fit. All of these tubes are of special stout metal, drawn solid and not seam-welded, or brazed, so well fitted that lubrication

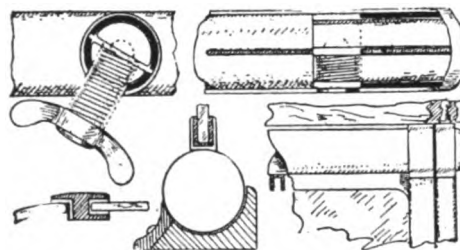

Interesting details of ingenious fittings of Godin's wind screens

is necessary. Along the tube is brazed the channel to carry the glass, and on each end a corresponding arm of suitable length. In the center or other convenient position on the outer tube there is a hole in which is inserted the thumbscrew. This engages in one of two half-round pieces of brass, which are inserted in the inner tube. These are of about 5 inches in length, and the end of the thumbscrew presses tightly against the one while it is being turned through the threaded hole in the other. Thus, on the principal of the internal brake, the two half-round pieces of brass are pressed tightly against the inner surfaces of the split inner steel tube and in turn against the outer brass tube. The sketches show the arrangement and the action by which the one tightens the other. In result, a perfectly firm hold is obtained on the center of the windscreen and one which will not slip.

The center sketch at the bottom shows how the round frame is fitted to the woodwork and a metal water guide fixed on the outside. This arrangement, without the guide, is applied to the top of all canopies and extension hoods, thus preventing any overhead draught or wind-driven rain getting over the top of the screen.

SLIDING ROOF LIMOUSINE

Labourdette, of Paris, has brought out a limousine body, known as the Prince Jaques. It has a roof which can be opened during the summer, so that a closed body for winter use is combined with a partially open car for the summer. The roof is made in sections and is operated the same as the drawers of a bureau. It is stated that the sensation of freshness which is experienced when the roof is opened is instant and exquisite, and is comparable to that experienced in a big show tent when the roof is removed. When the roof is opened, what remains of the Prince Jaques limousine is substantially a wind shield completely surrounding the occupants and protecting them against both the wind and the dust. When it is closed the limousine looks just exactly as any other vehicle of the same type.

COMMERCIAL VEHICLE MEN TO MEET

Plans are being perfected by the National Chamber of Commerce for a convention of commercial vehicle interests to be held some time in October to further advance the work that has been done during the past two years.

IS THERE A POWDER PLOT?

By E. G. Buckner, Vice-president Du Pont Powder Co.

Harper's Weekly recently printed two articles under the titles, "The Powder Trust" and "The Powder Plot," which grossly misrepresented the du Pont Powder Co. and did it great injustice.

As a matter of fact there is no statement, inference or conclusion reflecting on the du Pont Powder Co. in either article that is not wholly fallacious.

(1) It was intended that the readers of Harper's Weekly should be convinced that the du Pont Powder Co., in entering into a certain contract with German manufacturers, 25 years ago, violated the Federal statute and were guilty of a felony.

What are the facts? In 1889 Admiral Folger, Chief of the Bureau of Ordnance, Navy Department, convinced that the Brown Prismatic Powder manufactured abroad was superior to that used in our Navy, ordered the du Pont Powder Co. to secure these processes. Armed with letters from Mr. Blaine, then Secretary of State, to our Ministers abroad explaining his mission, Alfred I. du Pont went to Europe and contracted for the right to manufacture this powder, compensation to be made by the payment of a royalty per pound on the powder manufactured until the same aggregated \$100,000. Thus, our Government was not only familiar with the contract but a party to it, for it obligated itself to pay and did pay these royalties.

We did "keep the German manufacturer informed of the amount of powder manufactured for our Government." How would it have been otherwise when our Government was the only purchaser and we had to make an accounting for every pound of powder manufactured?

The records are public and I defy anyone to show from them anything justifying the astounding charge that the du Ponts in making or carrying out this contract were the "monopoly paid spies of a foreign government" and therefore guilty of treason.

This contract came to an end in 1898. It in no manner related to our present smokeless powder.

(2) It is charged that the du Pont Co., in selling to foreign governments the "identical powder used by our own Government," betrayed government powder secrets and was thereby "guilty of a criminal offense."

The utter nonsense of this will be apparent when the fact is known that the du Pont Powder Co. has never sold a pound of smokeless powder abroad without first consulting with government officials, and, in each instance, the powder sold has been tested by government officers at the Government proving ground.

There are no "powder secrets." The identical specifications on which the present Government powder is made are printed in a book published by Major Erasmus M. Weaver, of the Army, and on sale at bookstores. Likewise, the specifications on which cordite, Great Britain's powder, is made are printed and sold by authority of "His Majesty's Government." Almost any chemist could take the publications referred to and make smokeless powder, but I doubt if it would be made with economy.

Every European nation that manufactures powder sells the identical powder used by such government wherever it can, as it sells armor, battleships, guns and all other ordnance material. European nations even go so far as to detail their army and navy officers to go to other countries and assist their manufacturers in landing these contracts.

It is the accumulated experience of decades that has given the du Ponts primacy in the manufacture of explosives, enabling them to work out processes, machinery and economies so essential to commercial success; and let it be known and remembered that every process and invention perfected by the du Ponts has been turned over to the Government, practically without cost, for use in its two plants!

With the above recital in mind, every item of which can be verified by official records, if there are any smokeless powder secrets, whose are they?

I would not have any one infer that I contend that army and navy officers have not aided in the development of our present smokeless powder, but I deny, nor will they contend, that the service rendered by them justifies the claim in Harper's Weekly as to Government secrets. They have tested and criticised and suggested. The du Ponts in their laboratories and experimental plants spent money and brought results.

(3) It would be made to appear that Senator Henry Algernon du Pont, who since 1906 has been identified with the committees on "Military Affairs" and "Expenditures in the War Department" of the Senate, has been looking after the interests of the du Pont Co. in Washington. This is ridiculous. Senator du Pont is neither an officer, a director, a stockholder, or an employee of the company, nor has he been since elected to the Senate, nor has he ever made any effort to assist it in Washington. During the eight years he has been in the United States Senate the price of smokeless powder for large guns has been reduced six times, from 70 cents to 53 cents per pound; and such limitations have been placed on the bills going out of his committees as to render it impossible for the army now to purchase any powder from the du Ponts.

Now the foregoing statements, every one of which can be verified and substantiated by official records, establish the following facts:

(1) That the contract for Brown Prismatic Powder was made at the instance and with the approval of the Government.

(2) That if there are any smokeless powder secrets, they are du Pont secrets.

(3) That while Senator Henry Algernon du Pont has been Senator nothing advantageous to the du Pont Co. has come from his committees.

These facts being established, I submit that I am justified in contending that the charges carried in the two articles in Harper's Weekly are without warrant or excuse and are grossly and outrageously unjust and unfair.

STARTING CRANK STILL NEEDED

The need of the starting crank has not been destroyed by the coming of the self starting systems which are now in use on such a large number of automobiles. In fact, to start the motor by turning it over by hand is not the only use for the starting crank. Occasionally one wants to time the valves or "feel" the compression, or turn the flywheel around so that the clutch case can be cleaned and drained. With the starting crank in its usual place at the front of the motor, this can be done.

TOO MUCH BRIGHT WORK

The superabundance of brass work on the car of a few seasons ago is now no longer considered good taste. How was it that people, who in the ordinary affairs of their lives would shudder at the thought of being ostentatious, would allow their cars to have the appearance of a circus wagon? It is the more strange since the motorists of that time had nearly all been carriage owners; yet what would they have said if the carriage builder had fixed on their brougham a pair of polished brass lamps? Even a polished brass bead on the quarters looked out of place.

LOSS BY BAD ADJUSTMENT

The industrial loss from the ill adjustment of workers to their duties is only a small part of the total loss.

The value of the individual who is competent increases far more rapidly than his market price. Even in rough labor, the kind of man an eight-hour day and 35 cents an hour can secure

is more economical than the 20-cents-an-hour man, working ten hours.

If positions were filled by men fit for them, if the wages were paid necessary to secure men who were fit, difficulties between employer and employe would be inconceivable.

SIDE LAMPS DISAPPEARING

Of all unlooked for developments, none has been so wholly unforeshadowed as the sudden and pronounced trend toward the elimination of side lamps, and even the inset dash lamp, which latter only came into fairly general use within a twelvemonth. There is no mistaking the tendency, however, toward the use of what may be termed double-purpose head lamps; that is, head lamps in which are fixed a separate and smaller bulb which will serve the purposes heretofore rendered by side lamps; when this is not to be the case, automatic devices which will dim the penetrating and dazzling headlight itself apparently will be utilized.

THERMOMETER TO INDICATE MOTOR'S HEAT

As a safeguard against overheating their engines, some automobilists are using on their cars a small radiator thermometer to tell them when the motor is running hot or the water is low in the radiator. The thermometer is mounted on a small metal disk which screws into the radiator cap where the driver can always see it. When the red liquid in the tube rises above 130, it passes in front of a hole in the disk so that it can be more readily seen.

STAVERING GOOD TIME

The 16th annual picnic, given by the employes of the Staver Carriage Co., was held at Calumet Grove, Blue Island, Ill., on July 11.

The most interesting event of the day was a ball game between the paint department and the trimming department, the former winning by the score of 4 to 2. The game was well worth watching as considerable rivalry existed between the two departments, which caused plenty of excitement. In addition to the ball game there was dancing, together with races and games of all kinds.

Everybody is happy and back at work harder than ever as a result of this recreation.

SOMETHING ABOUT HOUSES—NOT TECHNICAL BUT TITTING

Houses are used to dot landscapes with, to pay taxes upon (if you scrape enough money together), and to keep rainstorms, cyclones, hurricanes, mosquitoes, book agents and callers from obtruding upon you too intimately.

Houses are composed of brick, lath and plaster, wood, nails and mortgages. A house without a mortgage is generally owned by a man without an auto. Some houses are made from cement, which is nothing but a species of glorified mud pie.

All houses began originally as caves and were used by primitive man. The only difference between a primitive man and modern man is in the architect's fee.

A house is built by contractors at the instigation of an architect, who begins by the statement that it will cost as much as he says it will. Every architect to be successful, therefore, must have two accomplishments—he must be an architect and an accomplished liar.

Houses have roofs over them to keep out the water and cellars below them to keep it in. They are usually filled with furniture, women's hats, people and unpaid bills. Sometimes they also contain servants and suffragettes—but never together.—Life.

RATES FOR CURRENT SHOW BIG DROP

The reductions in the rates charged for electricity by the New York Edison Co. during the past three years may be taken as conclusive evidence of the increasing use of electric vehicles. Prior to July 1, 1911, the rate averaged approximately 3½ cents per kilowatt-hour. Between July 1, 1911, and May 1, 1914, the rate was reduced to less than 3¼ cents, and on May 1, 1914, the minimum rate, based upon the consumption of 50,000 kilowatt-hours monthly, was lowered to 2 cents a kilowatt-hour. The new rates, which are as follows, are upon a minimum monthly bill of \$25: The first 2,500 kilowatt-hours monthly at 5 cents; next 2,500 kilowatt-hours monthly at 4 cents; next 5,000 kilowatt-hours monthly at 3 cents; next 20,000 kilowatt-hours monthly at 2½ cents; next 20,000 kilowatt-hours monthly at 2¼ cents; over 50,000, 2 cents.

TRADE AND EDUCATION

The Firestone Tire & Rubber Co. has furnished an industrial library for the use of the employes. The library is conducted on the usual plans for such institutions.

EXPIRED PATENTS

The following lists of patents, trade marks and designs of interest to our patrons are furnished by Davis & Davis, solicitors of American and foreign patents, Washington, D. C., and St. Paul Building, New York City.

- 582,323—Means for Lubricating Vehicle Spindles. Aubrey E. Streadwick, Kingston, Jamaica.
 582,374—Apparatus for Patching Pneumatic Tires. John F. Rau, Chicago, Ill.
 582,429—Thill Coupling. Thomas D. Lines, Syracuse, N. Y.
 582,438—Thill Coupling. John Scheidler, Coldwater, Mich.
 582,453—Cushion Tire for Wheels. Luther H. Carr, Canton, O.
 582,492—Spring Shackle for Vehicles. Henry C. Swan, Oshkosh, Wis.
 582,511—Pneumatic Tire. Henry C. Williams, Trenton, N. J.
 582,555—Vehicle Spring. Andrew A. Smith, Hotchkiss, Colo.
 582,584—Vehicle Brake. Forqus O. Godman, Ft. Wayne, Ind.
 582,699—Antirattling Thill Coupling. Herman W. Slater, Chicago, Ill.
 582,738—Combined Pole-Safety and Antirattler. Valentine Hartman, Yorkville, Ill.
 582,805—End Gate for Wagons. John P. Boulton and Levi E. Mark, Gridley, Kas.
 582,803—Coupling for Vehicle Poles. Carl H. Anderson, Ogden, Iowa.
 582,814—End Gate for Wagons. Frederick F. Emrich, Little Rock, Ark.
 582,824—Wheel Hub. Seth H. Leavenworth, Cincinnati, O.
 582,830—Pneumatic Tire. John Pearson, Leveoshulme, Eng.
 582,841—Dumping Wagon. Gottlieb Yung, Columbia, Pa.
 582,854—Vehicle. Charles Fournier, Danville, Canada.
 582,880—Thill Tug for Harness. John W. Salzman, Bloomington, Ill.
 583,051—Scoop Board for Wagon Beds. John Gross, Decatur, Ill.
 583,071—Vehicle Spring. Seth M. Moore, Norman, Okla.
 583,190—Wheel Hub. Neff E. Parish, Cleveland, O.
 583,195—Axle Spindle. Charles A. Ferguson, Theodore, Md.
 583,198—End Gate Fastener. Nundy Kirchner, Antioch, Mo.
 583,290—Drop-weight for Vehicles. William L. Johnson, Pico Heights, Cal.
 583,362—Elastic Wheel Tire. Edward E. Dulier, Mildenhall, England.
 583,373—Dumping Wagon. Thomas Hill, Jersey City, N. J.
 583,295—Device for Raising or Lowering Buggy Tops. James A. M. Tyler, Lexington, Neb.
 583,530—End Gate for Wagons. Charles H. Green, Swaledale, Iowa.
 583,593—Thill Coupling. Samuel B. Elder and William A. Manchester, Warsaw, O.
 583,673—Attachment for Wagon Seats. Charles F. Deplanty and Elmer E. Wilson, Coffeyville, Kas.
 583,773—Thill Coupling. Nicholas R. Shultz, Lake City, Mich.
 583,805—Axle Spindle and Box for Vehicles. Joseph Keagy and Joseph D. Wisenburgh, Coshocton, O.
 583,816—Thill Coupling. Charles T. Redfield, Glen Haven, N.Y.
 583,827—Tire. Henry R. Swindler, Jr., Mitchell, S. D.
 583,865—Tire Attaching Device for Vehicle Wheels. Robert Cowen, Cambridge, Mass.

FOREIGN TRADE OPPORTUNITIES

Further information may be obtained from the Bureau of Foreign and Domestic Commerce, Washington, D. C., by giving the number of the item referred to.

No. 13,361. Catalogs for consulate—The American consul at Dairen (Dalny) Manchuria, recently received inquiries for catalogs of American goods, which he was unable to furnish. As the consul wishes to establish a catalog filing system, he desires manufacturers of the following articles to send their latest catalogs: Automobiles and motor trucks, bells, bicycles, motorcycles, boats, boilers, brushes, carriages and wagons, chemicals and dyes, china and earthen ware, clocks and watches, dairy-men's supplies, electrical apparatus, elevators, excavating machinery, hardware, lighting apparatus, marine engines, paints and varnishes, sporting goods, vehicles, windmills, and pumps. These catalogs will be made available to business men interested in American articles.

No. 13,355. Motor cycles—An American consular officer in a European country reports that a resident of his district desires illustrated catalogs and prices of motor cycles from two to five horsepower. Correspondence may be in English.

No. 13,340. Motor street rollers—A business firm in a European country informs an American consular officer that it is desirous of hearing from American manufacturers of motor street and road rollers.

No. 13,347. Vacuum street cleaners—A business firm in a European city informs an American consular officer that it is desirous of being put in touch with manufacturers of vacuum street cleaners, such as are used in various American cities. This cleaner is in the form of a motor car of about 60 horsepower, which operates the cleaning apparatus and supplies the locomotion. It is described as being about 18 feet long and 7½ feet broad and capable of covering from 11,000 to 15,000 square yards of street per hour.

No. 13,335. Motor cars and motor cycles—An American consul reports that a local dealer in motor cars and motor cycles desires to take the exclusive agency for low and medium priced motor cars and motor cycles of American make. He wishes to receive catalogs with price lists and discounts, so as to make a selection of the kind of motor vehicles he desires to handle. Firms wishing to correspond with him may use English, setting forth whatever proposition they may have for the establishing of an agency. It will be useless to send catalogs without prices and discounts. C. i. f. prices of delivery should be given as an inducement to overcome European competition.

No. 13,435. Automobile tires—A wagon and automobile manufacturer in a European country informs an American consulate that he desires the agency of a staple make of automobile tire. The inquirer has lately opened a garage and will be well equipped to handle such a line successfully.

No. 13,370. Electric motors—A firm in Canada informs an American consular officer that it desires to be put in touch with American manufacturers of electric motors.

No. 13,371. Oil, woods, steel, copper, and brass—An American consular officer reports that a firm in his district is in the market for oleo oil, hard woods, copper and brass in sheets and disks. References are furnished.

No. 13,392. Motors for automobiles—Consul states that an automobile manufacturer desires to obtain from American manufacturers light motors for automobiles. Correspondence in English.

No. 13,394—Cycle cars—An American consul desires catalogs, price lists and the necessary literature be sent to a local business man, who desires agency.

No. 13,372. Leather—An importer, with agencies in other cities, is in the market for leather, and he would like to correspond with American manufacturers of this article. Quotations should be made c. i. f. city of destination, and payments will be made at a local bank against documents. Correspondence should be either in French or English.

No. 13,373. Leather for furniture and carriage making—A business firm in the Levant is in the market for American lumber adapted to furniture and carriage making and informs an American consular officer that it would like to hear from American exporters of this product.

No. 13,367. Leather—A local business firm would like to secure the agency for American manufacturers and exporters of leather. Correspondence may be in English, and prices should be quoted c. i. f. city of destination.

No. 13,369. Hardware and novelties—A report from an American consular officer states that a firm in his district operating a large department store desires to secure c. i. f. quotations from American manufacturers of hardware and novelties of all kinds. Correspondence may be in English.

No. 13,431. Gas engines—A communication from a foreign business house stating that it wishes to hear from American manufacturers of gas engines of from 35 to 100 horsepower. The firm desires prices, discounts, etc., with a view to representing such manufacturers in a certain territory.

No. 13,434. Agricultural implements, etc.—A business man in France who is about to open a large general store, desires to be placed in direct communication with American manufacturers of agricultural implements, tools, etc. Correspondence should be in French.

No. 13,413. Bicycles—In view of the great and growing demand for bicycles among the residents of a foreign country, a firm of importers informs an American consulate that it desires to receive catalogs on bicycles together with prices and discounts. It will greatly facilitate the placing of orders if firms sending catalogs will forward c. i. f. quotations certain port. Correspondence should be in English.

No. 13,414. Small timber frames—A business firm in the United Kingdom desires to purchase small timber frames about 12 inches square, mitered at the corners, and made of close-grained wood. The firm also wants to buy poles 4 feet long, 3 inches in diameter, turned and finished ready for polishing.

No. 13,416. Old metal—A firm in the Levant having large quantities of old metal, such as copper and copper mixed with zinc, in ingots of from 60 to 100 pounds, informs an American consular officer that it desires to correspond with American firms interested in purchasing such metals.

No. 13,418. Motorcycles—An officer in a European country is in the market for a high grade motorcycle of American manufacture. Catalogs and printed matter, in German or French, should be forwarded directly to the officer in question. It is intended to use the machine in motorcycle contests, so that the prospects for additional sales would seem to be promising.

No. 13,421. Leather, engines, tools, motor cars, and oils—A report from an American consul states that a business firm in a Mediterranean country is in the market for the following articles and solicits correspondence in Italian from American firms: Leather, engines, and machines of all kinds, machine tools, motor cars, and accessories, oils, etc. Prices should be quoted c. i. f. certain ports.

No. 13,422. Marine motors—An automobile firm of good standing wishes to take up the sale of motors suitable for sailing vessels employed for fishing, also smaller motors for launches, etc. As there are over 400 fishing vessels in the country in which motors could be used, it is believed there exists a considerable market for these motors. Information and descriptive literature as to motors, prices, and terms of sale are desired. Exclusive agency is sought for the country in which the dealer is located. References will be furnished, and correspondence is preferred in French, although English could be translated.

No. 13,423. Electric commercial cars—A telegram has been received from an American consular officer stating that a responsible person in his district desires the sole representation of American firms manufacturing electric commercial cars not represented in the country in question. Cable quotations are

desired on cars of one, two, three and four tons, with discounts, etc.

No. 13,425. Machinery—Tenders are invited by the Victorian Railways Commissioners for the supply and delivery of various woodworking and ironworking machinery for the workshops at Newport, Melbourne.

No. 13,407. Agricultural machinery and implements—An agricultural association in a European country imports annually large and increasing quantities of agricultural machinery and implements, and it would welcome descriptive matter and direct quotations for American agricultural machinery and implements for plowing and tilling the soil, for harvesting, for cleaning and sorting of grains (principally wheat), for cutting fodder, etc. The country is such that medium and small sized machinery is preferred. Correspondence should be in Italian, and quotations should be made c. i. f. certain city.

No. 13,398. Agricultural implements and machinery—A foreign ruler has stated to an American embassy that his subjects are in great need of agricultural implements and machinery of all kinds, and he desires to enter into negotiations for the purchase of such machinery. There are about 3,500 villages in his district, and he is willing to make it obligatory for the larger ones to contribute a definite sum annually toward the purchase of implements.

No. 13,402. Leather, brass, and copper—A business firm in the Near East with branches in several trade centers informs an American consular officer that it desires to get in touch with American exporters of the following articles: Calf and goat skin leather, and brass and copper in discs and sheets from 1/64 to 1/8 of an inch in thickness. Prices should be quoted c. i. f. port of entry. References are furnished.

No. 13,405. Rubber goods of all kinds—A business firm of wholesalers and importers of rubber goods, doing a considerable business throughout Italy, informs an American consular officer that it desires direct connections with American manufacturers of rubber goods and machinery of all kinds. Correspondence is preferred in Italian, though French is understood. Prices should be quoted c. i. f. Genoa or Venice, weights and measures should be in the metric system.

No. 13,406. Machinery for cleaning horses—A European firm wishes to be placed in communication with American firms making machinery for cleaning horses. This firm informs an American consular officer that it has 500 horses in daily use and is anxious to acquire machinery which will clean them.

No. 13,444. Agency for importing American goods—An American consular officer in the Far East reports that a local firm has decided to enter the importing business and is about to establish an office for that purpose. The prospects for a large increase in trade in the region in question are very bright, and the time is opportune for American firms to get a foothold in this region. Copy of the complete report, giving further detailed information, can be obtained from the Bureau of Foreign and Domestic Commerce.

13,256. Leather Belting—A business firm in a European country has requested to be put in touch with American exporters of leather belting.

13,259. American Goods for Norway—A Norwegian business man, who is now in the U. S., would like to get in touch with firms desiring to do business in that country.

13,261. Horse Covers—A business firm in Canada desires to be put in touch with American manufacturers of horse covers.

13,263. Hardware—A hardware merchant in a European city wishes to be placed in direct communication with American manufacturers of such products.

No. 13,285. Motor cars and motor trucks—A report from an American consul states that the use of automobiles is increasing in his district, and there are now more cars of American make used than of any other make. There appears to be an opening for the use of motor trucks to convey products from the farms and villages to the ports and to bring back supplies needed. A municipality is advertising for bids to supply motor

sprinklers and motor garbage carts. Further details, as well as a list of dealers in automobiles and supplies, will be furnished to interested American manufacturers.

No. 13,288. Leather—A report from an American consular officer in a European city states that a commercial agent with considerable experience in the leather trade desires to get in touch with American leather concerns. Correspondence may be in English.

No. 13,278—A business man in South Africa informs an American consulate that he is anxious to ship to the United States hides and skins, and would like to hear from American firms importing these articles. Correspondence in English.

No. 13,245—An import agent with a well established business in a European city informs an American consular officer that he desires to hear from American exporters of buffalo leather, such as hand buff and machine buff, sizes 50 to 55 feet, in brown and green. Prices, term, and samples should accompany first letter.

No. 13,256—A business firm in a European country has requested to be put in touch with American exporters of leather belting, with a view to purchasing on the American market. The firm is interested in beltings of the following widths, in inches: 2, 2½, 3, 4, 5, 6, 7, 8, 9, 10, 12, 15, and 20. The firm states that it consumes an average of about 200 meters of each width annually. The firm would be glad to have samples of leather submitted, together with prices and terms; quotations c. i. f. city of destination are especially desired. The firm states that it will pay against bill of lading at a local bank. The consular officer who submitted the report states that the demand for leather belting is increasing, and the firm making the inquiry is one of the largest dealers in his consular district.

DOMESTIC TRADE OPPORTUNITIES

Norman & Co., Columbus, Ga., will move into a new building and add modern equipment for blacksmithing and carriage making, and handle harness.

A. G. Hall & Sons, San Antonio, Tex., will resume business after fire loss is adjusted.

CATALOGS WANTED

Consul Geo. A. Bucklin, Jr., Bordeaux, France, writes, manufacturers and exporters seeking a market in southwestern France are requested to send copies of their latest catalogs, preferably in French, to his office, giving at the same time the address of any branch office or agent which they may have in Bordeaux or in any other part of France. In many lines, such as automobiles, agricultural machinery, lumber, tools, hardware, etc., a good market can be developed. American exporters should notify consular officers of agencies or branch offices established so that there may be full co-operation.

MACHINERY WANTED

Folbert Bros., Middletown, O., manufacturers of carriages, whose plant was recently destroyed by fire with a loss of \$50,000, are preparing plans to rebuild. Woodworking machinery will be required.

CAN'T IMPROVE ON WEST CHESTER

Hoopes Bros. & Darlington, according to reports in daily prints, were "incorporated in New Jersey to build carriages in Pennsylvania," which is a fair average sample of the kind of news (?) that gets by daily in the public prints.

Fact is, the corporation chose New Jersey for a legal birth-place for business reasons, but wheels will continue to be made in the best manner at West Chester, Pa., as they have been these many years.

THIS AND THAT

Artificial light in foundries should have a yellow cast. Yellow rays penetrate smoke and fumes and dust better than others, and the powerful yellow-flaming arc light has been found to be adapted to every requirement.

One manufacturer selling wagons in nearly every state in the union reports that in order to ship one wagon it is necessary to have a stock of 4,800 wagons.

The 900,000,000 bushel wheat crop will be harvested from approximately 52,000,000 acres, bringing the average yield per acre for the whole country up to 17 bushels. This figure is unsurpassed. To harvest the crop within 14 days, 247,333 binders will be required. To purchase this number of machines the farmer invested something like \$30,000,000.

In order to conserve its resources in view of the fact that it will shortly place on the market a popular priced car, which will be an addition to its present line of higher priced vehicles, the Peerless Motor Car Co., Cleveland, O., has deferred the payment on its 7 per cent. cumulative preferred stock.

A new spring wheel from Glasgow, the invention of Elwood Ellis. This wheel is beyond the paper stage. Mr. Ellis relies upon the resilient qualities of a steel ribbon in tension, and the impression obtained is that the solid tire is nearly the equal of the ordinary pneumatic. For those who want freedom from tire trouble and who do not desire the highest speed, this wheel offers improvement on the solid tire.

The wheel consists primarily of three parts, the inner rim carrying the steel ribbon, the outer rim carrying the tire and floating on the ribbon and the side ring, which covers the working parts. The wheel is not clumsy in appearance, and contains no parts likely to give trouble, while even if the steel ribbon fails the wheel can be driven without mishap, the actual free movement being small. The ribbon is stretched in a series of tangents, and at four points there are straining bolts adjustable from outside the wheel, by means of which the tension of the ribbon can be adjusted. The outer rim carries inward projections with slots through which the ribbon passes, the tangent arrangement of the ribbon taking the drive. It might be thought that considerable creeping would occur, but experience shows that this is not the case.

It is evident that with the ribbon at proper tension the outer rim carrying the solid tire is floating on the ribbon. Also the resilience of the wheel does not depend upon any one section of the ribbon, but any shock is spread over the whole ribbon, while there is very little variation in the effective radius of the wheel.

The adoption of the two-speed rear axle by the Cadillac Motor Car Co., Detroit, has resulted in a patent suit against it by W. S. Austin, head of the Austin Automobile Co. He charges in a suit in the United States District Court in Grand Rapids, Mich., that patent number 1,091,618, issued March 31, 1914, which he holds, has been been infringed.

Of the thirteen different makes of cars in big French race, nine were designed with four valves in the head of each cylinder, two intakes and two exhausts, the only two companies of note using but two valves per cylinder being Fiat and Schneider. Where the valves are inclined at 45 degrees or thereabouts, two camshafts are generally used, but where the valves are mounted vertically in the cylinder head, one overhead cam shaft suffices.

All entrants have recognized the superiority of the overhead valves and firms which a year ago raced with L or T-head motors have been obliged to come out boldly for the overhead type.

CARRIAGE BUILDERS', WHEELWRIGHTS' AND MOTOR CAR BUILDERS' NAT'L ASSN. OF NEW ZEALAND

The second annual convention of the above took place in Auckland. It was a success, and an advance upon the inaugural meeting held at Wellington twelve months previously. Auckland is the largest city in the Dominion, and is an important carriage building center, some of the oldest and best known firms in the Dominion being located there. Almost every part of New Zealand was represented, and the convention was the means of bringing out a few enthusiasts who will no doubt play an important part through the medium of the association in influencing the future of the trade.

The work already done by the association, as set out in the reports of the president and the executive justifies its existence. On no previous occasion has the whole trade of the Dominion been so thoroughly and earnestly canvassed with a view to its organization, and although the present membership may appear small in comparison with the total number affected, it is a satisfactory beginning. The list includes many well known names in the trade.

The business sheet presented to members included some important matters.

The new president, William Atkin, is one of the best known men in the New Zealand trade. He is one of three sons of the late Charles Atkin, one of the founders of the business of the Cousins & Atkin Carriage Factory, Ltd., which dates back to 1864.

Timaru was selected as the place for the next convention which is to be held at Christmas time, 1914.

THE ACCOMPLISHED FACTS

The Society of Automobile Engineers at Cape May convention finished the following work:

1. Iron and Steel Report adopted. 2. Report of Broaches Division. 3. Report of Motor Testing Division. 4. Standard Rim Tests accepted. 5. Insulation Tests are adopted.

Papers—6. Seventeen papers are presented. 7. Valuable discussions resulted. 8. Papers of instructive value. 9. Papers follow standards work.

Business—10. New Constitution is adopted. 11. New members added number 207. 12. Student enrollment is accepted.

BIG TRADE OPPORTUNITIES**1914 Implement and Vehicle Shows**

National Implement and Vehicle Show, Peoria, Ill., Sept. 4-12.
Tri-State Vehicle and Implement Dealers' Association show, Cincinnati, O., October 19-24.

Iowa Implement Dealers' Association show, Des Moines, Ia., November 30-December 5.

Wisconsin Retail Implement and Vehicle Dealers' Association show, Milwaukee, Wis., December 7-12.

1914 C. B. N. A. Convention

Atlantic City, September 28-October 2.

DEALERS' CLAIMS NOT PREFERRED

Claims held by retail dealers against the Michigan Buggy Co., of Kalamazoo, Mich., are to be treated the same as the claims of other creditors, according to a ruling of the referee in bankruptcy. These claims were created by the giving of notes in advance for goods which were never delivered. The claims aggregate \$17,000. The holders thought that they would be classed as preferred claims and paid in full.

The receiver of the company has distributed the fourth dividend of 5 per cent. Whether any further payments will be made is problematical.

PERSONAL

Manley Mix-up

Every effort is being made by Mr. and Mrs. Guy Barnett, who eloped and were married at Union, Mo., to bring about a reconciliation with the bride's father, J. D. Manley, president of the Manley Carriage Co., St. Louis. Barnett just obtained a divorce from his first wife. After their marriage the couple sent a telegram to Mrs. Barnett's parents, but it was unanswered. Manley objected to his daughter marrying so soon after Barnett had obtained a divorce. Before her marriage Mrs. Barnett was Miss Bernardette Manley.—St. Louis Globe-Democrat.

Will Hit the Buggy Trail

J. G. Blount, son of B. M. Blount, head of the White Hickory Wagon Mfg. Co., Atlanta, has been placed on the sales force. The new traveler will handle a south Georgia territory. He has several years' experience in the office and factory and goes on the road equipped with knowledge of the business.

Sells Buggies in Automobile

Salesman Hawkins travels about in Georgia (when not stuck in the mud) in an automobile. It is his way of selling buggies. Hawkins is a White Hickory product.

Wildflower Aquatics

Employees of the Woodward Carriage Co., headed by Harold Armstrong, in charge of the parts department, have organized the Wildflower Aquatic Sports Association, which has for its object the perfection of the efficiency of the members in swimming and diving. The San Antonio river, in the rear of the Woodward Carriage Co., provides the necessary "swimming hole." The members do the rest after 6 o'clock each evening. Armstrong has been elected "Exalted High Life Preserver," while W. A. Wavery, chief electrician of the Woodward Carriage Co., has been selected as "Most Noble Regulator of the Bath."

Formerly With Michigan Buggy

George Edwards, Jr., formerly connected with the Michigan Buggy Co., in the capacity of assistant purchasing agent, has accepted a position with the recently formed Dodge Motor Car Co., of Detroit.

Prison Bookkeeping

Victor L. Palmer, former financial head of the Michigan Buggy Co., recently sentenced to two years in Fort Leavenworth for violation of the postal laws, is now a bookkeeper in the prison. Palmer got his start in Kalamazoo as a bookkeeper. A country boy, he went to Kalamazoo, graduated at a business college and kept books for the buggy company, being promoted finally to its head.

"White Hickory" Crop Report

A report of crop conditions, being secured by the White Hickory Wagon Mfg. Co., Atlanta, Ga., from their customers throughout the south and now partially completed, indicates the average reply will show crops 15 to 20 days earlier this year than last. The White Hickory Co. has been gathering these reports from its customers each year for many years, making use of the information in routing their salesmen and in a broader sense in shaping their general policies for the year.

Big Drop in Wheels

Forty thousand wheels, owned by the Hayes Wheel Co., Jackson, Mich., and stored in an old frame building, caused the partial collapse of the building. The second floor, where the greater part of the wheels were stored, first gave way, which was followed by the collapse of the side of the building adjoining. A building in the rear prevented the rear wall from

going down altogether, and the collapse of the side wall was blocked by a freight car standing on the track and filled with wheels, and had it not been for this car the entire side of the building would have gone out.

Big Thing—Million Big

New Orleans is to have a \$1,000,000 automobile manufactory employing 2,000 men. The plant will turn out motor cars of all descriptions, as well as freight trucks, gasoline engines, motors and kindred products. This announcement was made by the stockholders, who elected J. Bart Davis president; A. C. Vreeland, vice-president; John Merkel, Jr., secretary, and the Citizens' Bank and Trust Co., depository. According to the prospectus the factory will take advantage of the excellent base for supplies such as rubber and hardwoods from Central America, and steel from Alabama, afforded by New Orleans, and from this central port defy competition for the sale of the finished product in Mexico, Central and South America, as well as the southern United States.

J. B. Childe has been made the general manager of the Cleveland Axle Mfg. Co. and the Cleveland-Canton Spring Co., Canton, O. Mr. Childe has had a splendid experience in the industry, having been formerly with the Hess Spring & Axle Co., Carthage, O., also serving in the capacity of auditor for the Western Spring & Axle Co. He is a young man of ability and his promotion is no surprise to his many friends.

Walter Scott, for many years associated with the Hercules Buggy Co., Evansville, Ind., is now representing the International Rubber Co., New York City, manufacturers of rubber carriage cloth. He will travel west.

A new factory and store building is to be erected by the Sherwin-Williams Paint Co., at Dallas, Tex. It will be of concrete, four stories high and estimated to cost \$30,000. E. F. Myers is the Dallas manager of the company.

A storm buggy catalog has been issued by the Parry Mfg. Co., Indianapolis, Ind., giving full description of their "storm proof" buggies for 1915. It is an attractive book, and is filled with good information.

Frank Smith Alive

Frank C. Smith, shall we say of Columbus, O., has returned to the services of the Banner Buggy Co. He is the youngest feller in the buggy trade whose memories go back to the long time ago. He's alive—you bet he is.

GOOD BUSINESS

The West Tire Setter Co., of Rochester, N. Y., reports business in the tire setter line to be very good so far this year. They have recently installed two of their larger machines, one in the plant of Geo. W. Garrett & Son, of Philadelphia, and the other in the shop of J. A. Shephard & Son, Brooklyn, N. Y. At present they are busy getting ready for shipment other machines which they have orders for.

HERE'S THE END AT LAST

"My intention in purchasing the Michigan Buggy Co. buildings," states T. Willard Reedy, the buyer, "is to bring to Kalamazoo many small factories, putting them all in this big plant. I hope to increase it to two or three times its present size and have twice as many people working there as were ever employed there before." The Niles capitalist purchased the Michigan Buggy Co. buildings, real estate and machinery for \$40,000.

The M. J. Grove Co., Lime Kiln, Md., want prices on a second hand wagon.

Trade News From Near and Far

BUSINESS CHANGES

Tiffin, O.—H. Sinhooner (repairs).
 Exeter, Neb.—N. P. Scott succeeds Spitz Bros.
 Ida Grove, Ia.—C. Hellman succeeds H. White.
 Shelton, Neb.—A. J. Ulrich succeeds C. S. Bailey.
 Summit, S. D.—Olaf Melby succeeds J. N. Shuber.
 Calhoun, Mo.—C. L. Vivian succeeds H. L. Redford.
 Dixon, Neb.—E. H. Oswald succeeds A. L. Fletcher.
 Columbus, O.—Justus & Parker Co.; capital \$15,000.
 Bowdle, S. D.—C. L. Roy succeeds Merkle & Meile.
 Bayfield, Wis.—W. J. Bassett succeeds R. J. Nelson.
 Metz, Mo.—S. J. Gregg & Son succeed E. L. Clelland.
 Inavale, Neb.—R. E. Strong & Co. succeed Wickwire.
 Waterford, Wis.—John Peters succeeds Hannin Bros.
 Earling, Ia.—A. Stinn & Son succeed R. Ford & Sons.
 Guthrie Center, Ia.—Reith & Clark succeed F. C. Webb.
 New Castle, Neb.—Maskell & Hayden succeed Johnson.
 Milbank, S. D.—W. W. Harper succeeds Farley Bros.
 Higginsville, Mo.—J. W. Rissler succeeds Edw. Freese.
 Merna, Neb.—Pirnie & Gordon succeed E. M. Coleman.
 Sioux Center, Ia.—J. Hudseth succeeds De Pree & Co.
 Cleveland, O.—Trenton Motor Sales Co.; capital \$5,000.
 Paxton, Neb.—John Campbell succeeds Chris Thorning.
 Whitewater, Wis.—John Grant succeeds Grant & Brown.
 Pleasanton, Tex.—H. C. Walker succeeds Allen & Smith.
 Lancaster, N. H.—H. Wells succeeds O. Haynes (livery).
 Menominee, Mich.—Auto Service Co. bought Poyer garage.
 Random Lake, Wis.—W. C. Mertz bought Altenhofen garage.
 Ravenna, Mich.—Griswold & Conklin succeed F. R. Griswold.
 Stromsburg, Neb.—Buick Auto Co. succeeds Olson & Granere.
 East St. Louis, Ill.—L. Edlich Wagon & Carriage Co. dissolved.
 Greencastle, Ind.—Cassidy & Browning succeeded by G. Coons.
 Essex, Ia.—L. Morgan bought half interest in A. D. Drake garage.
 Dell Rapids, S. D.—Dell Rapids Auto Supply Co.; capital \$20,000.
 Boone, Ia.—F. G. Peterson has gone in with Boone Carriage Works.
 New Lison, Wis.—Sanderson & Little sold to Sanderson & Bunker.
 Cambridge, Neb.—C. E. Correll sold interest in Cole & Correll to L. Yutzy.
 Stromsburg, Neb.—O. Olson sold interest in Olson & Granere to J. Ostblom.
 Sedalia, Mo.—Hampton-Wood Merc. Co. succeeds A. M. Hampton & Co.
 Olivet, Mich.—G. C. Alden of Grand Forks, N. D., succeeds A. H. Cover at Olivet.
 Silver City, N. M.—H. Gietz and J. W. Pinkerton purchased interest in E. Cosgrove, Inc.
 Cincinnati, O.—Cincinnati Velie Motor Sales Co. changed name to Wagner Automobile Co.
 Plymouth, Wis.—Maxwell Co. (hearse bodies) failed with \$19,595 liabilities, assets \$35,196; filed voluntary petition.
 Marshfield, Wis.—John McDonald and Bob Herrick, doing business as Hub City Auto Co., dissolved partnership; John McDonald continues.

NEW FIRMS AND INCORPORATIONS

Erwin, S. D.—P. Q. Tulp.
 Marcus, Ia.—C. C. Iverson.
 Spencer, Neb.—John Chore.
 Carson, Ia.—Fox & Chaney.
 Axtell, Neb.—J. H. Downer.
 Fairview, Kas.—Louis Miller.
 Mapleton, Minn.—J. H. Dee.
 Walhalla, N. D.—N. Tetrault.
 Olsburg, Kas.—E. Lohmueller.
 Coffeyville, Kas.—Chas. Christ.
 Wales, N. D.—Wales Imp. Co.
 Nashua, Minn.—B. F. Buettner.
 Nashua, Minn.—B. F. Buettner.
 Kearney, Neb.—Roy Tonkinson.
 Johnstown, Neb.—Ralph Walsh.
 Fleming, Colo.—Chas. O'Rourke.
 Talmage, Kas.—D. J. Smith & Co.
 Washburn, N. D.—Everson Bros.
 Superior, Neb.—O. Bagley (garage).
 Vivian, S. D.—Albert Boal (garage).
 Washington, Kas.—W. J. Dunnuck.
 Chippewa Falls, Wis.—Biboltz Bros.
 Minneapolis, Minn.—Regal Motor Co.
 Eau Claire, Wis.—H. Storley (garage).
 Minneapolis, Minn.—J. P. McGuire Co.
 McGregor, Ia.—Zimmerman Hotel Co. (garage).
 St. Louis, Mo.—Weiss-Boslev Co.; capital \$5,000.
 New Orleans, La.—Acme Auto Co.; capital \$18,000.
 Joliet, Ill.—Middle West Auto Corp.; capital \$1,000.
 Detroit, Mich.—Savage Motor Car Co.; capital \$5,000.
 Detroit, Mich.—Aetna Motor Truck Co.; capital \$5,000.
 Greensboro, N. C.—R. G. Sloan Motor Co.; capital \$25,000.
 St. Louis, Mo.—Champion Motor Car Co.; capital \$50,000.
 Ft. Smith, Ark.—Ft. Smith Vehicle & Mch. Co.; capital \$5,000.
 White Bear, Minn.—White Bear Imp. Co. will handle buggies.
 St. Matthews, S. C.—Fairey-Bates Motor Co.; capital \$2,500.
 Chattanooga, Tenn.—Forstner-Shackelford Co.; capital \$5,000.
 Orange, Tex.—Orange Buggy and Imp. Co.; capital \$30,000.
 Ellensburg, Wash.—Reliable Motor Car Co.; capital \$20,000.
 McClellan, Gallup & Denman will open for business in Abbott, Neb.
 Muskogee, Okla.—W. F. Lantz Carriage & Automobile Co.; capital \$25,000.
 Carlisle, Ky.—J. Archdeacon, Sr., sold interest in J. Archdeacon & Sons.
 Chicago, Ill.—Chicago Wheel Co.; capital \$2,500; wheels, tires and bodies.
 A. R. Tomlinson Co., a new institution at Charleston, S. C., to sell buggies, harness, etc.
 Bedford, Ind.—M. C. M. Motor Co.; capital \$10,000; W. M. Mathews, L. Cobb, E. Morris.
 McGeorge & Bevar will engage in vehicle, hardware, and harness business in Attica, Ind.
 J. J. Grady, Mechanics street, Worcester, Mass., is a new wagon repair and blacksmith shop.
 The Howle & Mellon Hardware Co. is a proposed concern in Dadeville, Ala., to handle vehicles, harness, etc.
 Milwaukee, Wis.—Simplex Demountable Rim Co.; capital \$150,000; M. and M. H. Rosenheimer, W. J. Sarres.

New York City—New Ideal Wagon Works, Inc.; capital \$10,000; M. D. DeWitt, J. T. Sturdevant, C. Frelloehr.

South Bend, Ind.—Overland-South Bend Co. (dealers); capital \$5,000; E. A. Bennett, W. Stewart, J. E. Kepperly.

Columbus, O.—Tesseyman Auto Co.; capital \$20,000; J. E. & I. A. Tesseyman, F. N. Boyd, J. F. Galloway, M. Heinrich.

Cleveland, O.—Kelley Sales Co. (auto); capital \$10,000; E. R. Gross, L. W. Kelley, F. T. Beaumont, D. V. Fisher, H. C. Luff.

Painesville, O.—Vulcan Carriage Co.; capital \$1,000,000; make motor cars; E. D. Hartwell, E. E. Lawrence, F. H. Murray, H. E. Hammar.

Cleveland, O.—Simplex Dis. Co. (autos); capital \$10,000; F. S. McGowan, E. A. Fotte, A. R. Manning, Jr., S. Chestnutt, M. N. Job.

Detroit, Mich.—States Cyclecar Co.; capital \$150,000; C. Valade, president; S. E. Jones, vice-president; Victor Valade, secretary and treasurer; G. W. Merideth, superintendent.

EXTENSIONS AND IMPROVEMENTS

Flint, Mich.—Walker-Weiss Axle Co. building addition.

Pawtucket, R. I.—M. J. Cavanaugh is in new carriage repository.

Detroit, Mich.—Canfield Garage Co. increased capital to \$12,000.

Detroit, Mich.—Fisher Closed Body Co. increased capital to \$500,000.

Bucyrus, O.—Seeger Bros. are enlarging carriage and blacksmith shop.

Kansas City, Mo.—Packard (K. C.) Motor Co. increased capital to \$40,000.

Preston, Ida.—Consolidated Wagon & Machine Co. will put up new warehouse.

Champaign, Ill.—Martin Metz is putting motor machines and electricity in wagon shop.

The Tampa (Fla.) Harness & Wagon Co. will increase room for display and warehousing.

Freeport, Ill.—The Henney plant has started up after shutting down for improvements.

Lowell, Mich.—Lowell Cutter Co. is about to reopen factory B of its plant at full capacity.

Wilson, N. C.—Hackney Bros. are building new factory addition; capacity, 25 vehicles daily.

Rapides Hardware Co., Alexandria, La., will soon move into a new building of increased room.

Seeger Bros. are remodeling and enlarging their carriage and blacksmith shop at Bucyrus, O.

Columbus, Ga.—Newman & Co. will have a new brick structure for carriage and blacksmith shop.

Hopkinsville, Ky.—Mogul Wagon Co. is moving machinery into new brick building addition to plant; shop is 84 x 100.

Milford, N. H.—Stable of Endicott Imp. Co. is being enlarged and will be operated by Russell & Moulton; W. M. Moulton in charge.

St. Johnsbury, Vt.—Thomas, Gray & Nichols have leased a new building and are to use it for a carriage repair and paint shop, using electric power.

A new building will be erected for the Schaefer Wagon Co., at its plant, 4170 to 4200 Lorain avenue, Cleveland, O. The structure will be four stories high. This building is planned to be fireproof. The first floor will be used for blacksmithing, the second floor for wood work and the two upper floors will be made into an ideal paint shop suitable for painting carriages, wagons, automobiles and heavy motor trucks. Motor truck work has been especially provided for by installation of a 15,000-pound electric elevator, heavy concrete floors and special high ceilings. The Schaefer wagon factory was established by Gustav Schaefer 34 years ago. Doing only hand-made work he has built up a big business. In April, 1913, The Gustav Schaefer Wagon Co. was incorporated. It employs 50 skilled mechanics, and its factory floor space is about 60,000 square feet, devoted

exclusively to making wagons and motor truck bodies and repairing, painting and trimming of carriages, wagons and automobiles.

FIRES

Watertown, N. Y.—L. E. Brown; slight.

Florence, Ala.—Robinson & Smoot; slight.

Carlyle, Ill.—Edler & Heithouse; loss \$1,500.

Antler, N. D.—Antler Implement Co.; loss \$1,000.

Langdon, Kas.—C. A. Henry; loss severe; has restocked.

Garden City, Mo.—Garden City Buggy Factory; loss \$50,000.

South Bend, Ind.—South Bend Wagon & Carriage Co.; loss slight.

San Marcos, Tex.—Sam Kone (repository); loss estimated at \$5,000.

August, Ga.—Lowery Wagon Works set afire by lightning; damage slight.

Harriman, Tenn.—N. C. Blanchard spoke factory; heavy loss, partly covered.

Boise, Idaho—Mitchell, Lewis & Staver concern destroyed; loss estimated at \$75,000.

Port Huron, Mich.—Havers Motor Car Co.; plant practically destroyed; loss about \$60,000.

The John J. Delker Buggy Co.'s plant at Henderson, Ky., was damaged by the tornado which plowed through the city recently, and flooded by the rain which followed the wind.

SEND CATALOGS

From various sources this department learns that the following concerns are branching out, increasing lines, erecting new and larger buildings and will welcome catalogs of vehicles, harness, side lines, novelties, sporting goods, etc.:

Hinckley (Minn.) Hardware Co.

Illinois Hardware Co., E. St. Louis, Ill.

Ehlers & Nique, Shabbona, Mich.; opening branch at Decker, Mich.

B. J. Keppers, Avon, Minn.

Garden City (Minn.) Hardware Co.

Cherry Mercantile Co., Fauland, Okla.

B. C. Knolle, DeKalb, Ill.

The Kraus Co., Port Washington, Wis.

Giese & Noonan, E. Grand Forks, Minn.

W. E. Austin, Kankakee, Ill.

C. E. Cowdry, Orleans, Vt.

Ernest Villwock, Swanville, Minn.

Wm. B. Leo, St. Clair, Minn.

Watson & Kuntz, Geneva, Ind.

F. R. Stadel, Scales Mound, Ill.

T. W. Doyle, Kingston, Pa.

Rockville (Ind.) Hardware Co.

Most of the above concerns handle vehicles and are good, live prospects.

PROPOSALS FOR GOVERNMENT SUPPLIES

Correspondence should be direct with the offices named, and specifications can usually be obtained at the points where the goods are to be delivered or the work is to be performed.

Navy Department Supplies—The Bureau of Supplies and Accounts, Navy Department, Washington, D. C., will receive bids for furnishing the following supplies. Firms interested therein should make application to the Bureau of Supplies and Accounts, giving the schedule number desired.

6909—Cotton web straps, white oak railroad ties; 6906—Rubber tubing, bags, gloves, etc. 6924—Oak tanned leather, pump leather, rigging leather, heavy linoleum; 6903—White oak, cedar, hickory, maple, pine, oak and spruce; 6932—Beeswax, rosin, turpentine; 6901—Dry red lead, white lead, zincs dry and in oil.

OBITUARY

William C. Barker, New Bedford, Mass., formerly a superintendent of the George L. Brownell carriage factory, died June 30, at North Rochester, at the home of his wife's parents. Mr. Barker had been in failing health for some months. For the past five or six years he had made his home at Montclair, N. J., while his business had been as New York and New England representative of James Cunningham Sons Company, who purchased the Brownell business in 1908. He had spent his entire life in the carriage business, having worked his way to the position he last held from boy's duties, advancing through all the various departments of the factory.

F. W. Denton, 62 years old, for many years engaged in the wagon manufacturing business in Winona, Minn., was stricken with heart failure July 4. Mr. Denton was a 40-year resident of Minnesota.

Jno. Esper, Sr., aged 84, a retired wagon manufacturer, has died in Bowling Green, Ky., June 23, from a complication of diseases, after a lingering illness. He was born in Germany and went to Bowling Green when 18 years of age. He leaves one daughter and two brothers.

William H. Hinds, a native of Gardner, Mass., died at age of 47, June 25, caused by a hemorrhage. He had much to do with vehicles as buyer and seller.

Philip Muhlich, aged 79, died at his home in Pittsburgh, in June. He was born in Germany and came to this country in 1857, locating in Pittsburgh. For many years he conducted a wagon works, retiring from business about a month ago. He leaves, besides a widow, three sons, six daughters, 17 grandchildren and four great-grandchildren.

John Ward, 51 years of age, of Arctic, R. I., died at his home in June. Mr. Ward was very well known as proprietor of one of the largest automobile, carriage, and sign painting establishments in Rhode Island. He conducted a paint shop in Arctic for a great many years until he was burned out about a year ago. Mr. Ward is survived by a sister, with whom he lived.

HENRY H. BECHTEL

Henry H. Bechtel, first vice-president of the American Oak Leather Co., died July 13, at his home, Cincinnati, O. Mr. Bechtel was in his 75th year. Shortly after the serving of the evening meal, he was taken with an attack of heart trouble, and death followed. He is survived by a son, John Bechtel, and a daughter, Miss Nellie Bechtel. Mr. Bechtel went to Cincinnati from Newport, Pa., in 1893, at the request of James E. Mooney, president of the company. He was elected vice-president and secretary of the concern on account of his knowledge of the tannery business. From 1893 until January 1, 1914, Mr. Bechtel served in the capacities to which he was elected. The first of the present year he was promoted to the position of first vice-president. His thorough knowledge of the tanning and leather business placed him among the experts of the country.

CONSULAR TRADE CONFERENCES

Consul Kenneth S. Patton, at Cognac, France, will be in the United States on leave of absence until about September 18, 1914. His permanent address while in the United States will be University, Charlottesville, Va.

Consul Alfred A. Winslow, at Valparaiso, Chile, is now in the United States on leave of absence. His headquarters will be at Crown Point, Ind., and he will call often at the branch office of the Bureau of Foreign and Domestic Commerce, 629 Federal Building, Chicago, Ill. He will be in the United States until about September 15.

WANTS

Help and situation wanted advertisements, 1 cent a word; all other advertisements in this department, 5 cents a word; initials and figures count as words. Minimum price, 30 cent for each advertisement.

PATENTS

Patents—H. W. T. Jenner, patent attorney and mechanical expert, 606 F St., Washington, D. C. Established 1883. I make a free examination and report if a patent can be had and exactly what it will cost. Send for circular.

CAR FRAME AND SPRING SUSPENSION

Something new is before us. The frame of the car (front end) has a snub nose, in place of the Hebraic droop. Pivoted to the frame is a bar that fastens direct to the axle, and again to the frame at its near end by means of a short spring.

The shocks of the road are eaten up as a cat laps milk. This is right, all others are wrong. We haven't time to explain, perhaps we can't, but write National Bar Spring Co., in Pittsburgh, and get the news at first hand.

INDEX TO ADVERTISERS

Baltimore Hub-Wheel and Mfg. Co.....	40
Cargill Company, The.....	40
Columbus Bolt Works.....	4th cover
Correspondence School of Carriage and Motor Drafting...	3
Cumberland Hotel.....	2d cover
Dennis Hotel.....	2d cover
Dowler, Chas. L.....	40
Du Pont Fabrikoid Co.....	3
Eccles, Richard, Co.....	2
Fairfield Rubber Co.....	3d cover
Gifford, John A., & Son.....	2
Jones & Co., Phineas.....	3d cover
Keystone Forging Co., The.....	3
Keystone Paint & Filler Co.....	3d cover
Lawson Co., F. H., The.....	3d cover
Masury, John W., & Son.....	2d cover
Meyer, John C., & Co.....	40
Miller Bros.	40
Mulholland Co., The.....	40
National Spring & Wire Co.....	4th cover
Palm, Fechteler & Co.....	2
Payne Co., E. Scott.....	40
Porter, H. K.....	2
Schlegel Mfg. Co., The.....	40
Sheldon Axle Co.....	2
Sherwin-Williams Co., The.....	1
Skinner Bending Co., The J. M.....	40
Standard Oil Cloth Co.....	4
Technical School for Carriage Draftsmen and Mechanics..	40
Virginia and North Carolina Wheel Co.....	4th cover
West Tire Setter Co.....	3d cover
White-Quehl Mfg. Co.....	40
Wilcox Mfg. Co., D.....	1
Willey Co., C. A.....	4th cover

BUSY BUYERS BRIEFS

JOHN C. MEYER & CO.
THE
LOWELL THREAD
MILLS
 HIGH GRADE SEWING THREADS AND SPINNING
 BEST IN THE WORLD
LOWELL, MASS. U.S.A.

Baltimore Hub-Wheel & Mfg. Company
 Manufacturers of
Wheels AUTO MOTOR CAR
 CARRIAGE
 WAGON
 Also **SPOKES and RIMS**
 Factory: Harford Ave. and B. & O. R. R.
 BALTIMORE MD.

CHARLES L. DOWLER
 CARRIAGE AND WAGON HARDWARE
 108 North Third St., Philadelphia, Pa.
CUSHION MANUFACTURER
 Pure Stearic Acid Candles. Wheel Stock. Snow
 Flake Axle Grease.

MULHOLLAND
BUGGY SPRING
 Reduces weight of springs one-half.
 Made in one size only but will fit bodies
 of all widths.
 Write for further particulars and prices.
THE MULHOLLAND CO. DUNKIRK, N. Y.

 **White's Brazing Sleeves**
 For applying Rubber Tires
 Send for Samples.
WHITE-QUEHL MFG. CO.
 431 E. Pearl St.
 CINCINNATI, OHIO
 UNLINED

E. SCOTT PAYNE CO.
 Carriage and Automobile
HARDWARE
 Horse - Shoers' Supplies
 362-364 North Gay St., Baltimore, Md.

AUTOMOBILE
Bodies AND CARRIAGES
 IN THE WHITE
 Estimates Furnished on Special Designs
MILLER BROTHERS
 Amesbury, Mass.

The Schlegel Mfg. Co.
 Rochester, N. Y.
 Manufacturers of Coach Lace
 and All Other Interior Trimmings

 One of the oldest and
 largest Rim Plants in
 the world.
BENT RIMS
 For Carriage and Wagon
 Wheels
 For Automobile Wheels
 We make prompt deliveries in
 HICKORY and OAK RIMS.
THE J. M. SKINNER BENDING CO.
 Toledo, Ohio

Carriage Mechanics

Desiring to improve their present
 Condition should attend the

TECHNICAL SCHOOL

FOR

Carriage Draftsmen and Mechanics

SUPPORTED BY THE

Carriage Builders' National Ass'n

The object of the School is to teach men to design
 vehicles and make working drawings, and to otherwise
 facilitate their work in the shop. Only those men em-
 ployed in carriage or automobile building or their acces-
 sory trades are admitted to its privileges.

The classes are conducted in three divisions, viz.: Cor-
 responding, Day, and Evening. The former is open during
 the entire year, while the day and evening classes are in
 session only from October 1 to April 1.

The tuition is moderate.

For prospectus and full particulars, write to the instructor,

ANDREW F. JOHNSON,
 20 West Forty-fourth St.,
 NEW YORK CITY

Cargill Service

has brought to the Cargill
 Company more Vehicle
 Catalogues than are made
 by any other printing
 house in America.

Cargill Quality
 is bringing The Best Auto-
 mobile Catalogues to our plant for
 Complete production—watch
 for our imprint in the Season's
 best books.

THE CARGILL COMPANY

DESIGNERS
 ENGRAVERS



PRINTERS
 & BINDERS

Grand Rapids, Michigan



"Self-Propelled Vehicles"

Fifth Edition, Revised.

A practical treatise on the theory, construction, operation, care and management of all kinds of Automobiles.

By

JAMES E. HOMANS, A.M.

Contains 608 pages and upwards of 500 illustrations and diagrams, giving the essential details of construction and many important points on the successful operation of the various types of motor carriages driven by steam, gasoline and electricity.

This work is now the accepted standard, explaining the principles of construction and operation in a clear and helpful way. This book will be sent postpaid to any address in the United States, Mexico or Canada upon receipt of \$2.00.

Address

Trade News Publishing Co.

24 Murray Street, New York

Lawson's Sunken Panel, Twin Metal Buggy Seats

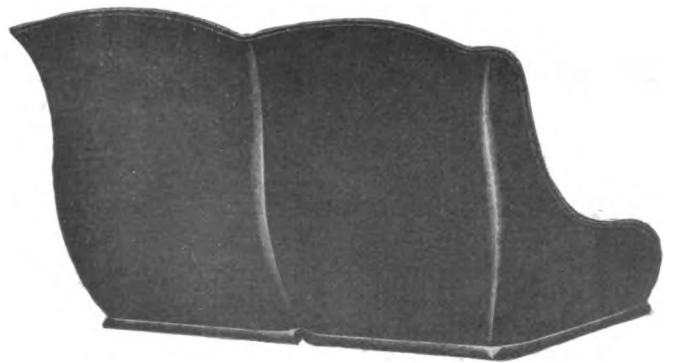

The Strongest—Neatest on the Market

Made in six sizes of 20 gauge automobile sheet metal. The Lawson seats are edged and bumped together by heavy presses.

We Use No Solder

Our seats were never known to come apart or rumble.

Write for Prices

The F. H. Lawson Co.

(Established 1816)

Cincinnati - - - Ohio

1855—Standard for 59 Years—1914

Jones Wheels

"Best on Earth"

The Name of Jones as Applied to Wheels Means the First, Last and All-the-Time Word in Wheels
"Kantsamore"

Buyers of vehicles should say, "Give me wheels made by

Phineas Jones & Co.

NEWARK

NEW JERSEY

U. S. A.

THE FAIRFIELD RUBBER COMPANY

Manufacturers of

**Carriage Cloth, Imitation Leather,
Automobile Cloths, etc.**

FAIRFIELD,

CONNECTICUT

The WEST Hydraulic Tire Setter WILL CUT DOWN EXPENSE



Tires set cold in one minute. This machine saves time—does the work better and quicker, does a way with burned streaks. Only necessary to measure one wheel in a lot. Does not char the rim, and thus make the tire loosen prematurely.

Saves resandpapering of wheels. This machine is now increasing the profits of many manufacturers. Send for catalog and read about it.

WEST TIRE SETTER CO.,

ROCHESTER, NEW YORK

KEYSTONE BLACK FILLER

MAKES A PERFECT

ROUGHSTUFF

For Automobile Bodies and Parts

It fills the pores of Metal and Wood perfectly. Sandpapers easily and produces a fine smooth surface that DOES NOT CRACK, SCALE NOR PEEL.

POMEROY & FISCHER, New York
Selling Agents to Vehicle Trade

KEYSTONE PAINT AND FILLER CO., Muncy, Pa.

BENT RIMS Hickory Second Growth and Forest Hickory
All Grades

OAK—STAR BRAND

SPOKES Second Growth Hickory—Finished and Club Head
SUITABLE FOR ALL VEHICLES, INCLUDING AUTOMOBILES

VIRGINIA AND NORTH CAROLINA WHEEL CO.

8 Bridge Street, New York City

RICHMOND, VIRGINIA

"BLACK VELVET" CUSHION SPRINGS

Manufactured Only by the
NATIONAL SPRING AND WIRE COMPANY
ALBION, MICH. WINDSOR, ONT.

THE SPRING OF QUALITY.



SPRING or SOFT EDGE CUSHION FRAME
For Buggies or Other Vehicles. Built of the Highest
Grade of Steel Wire.

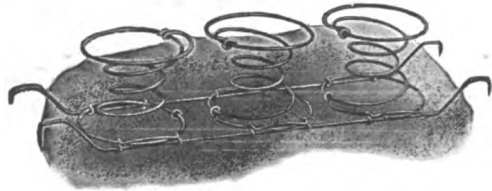

STRIP FOR WOOD OR BOX FRAME

WILLEY'S
COLORS

The **RECOGNIZED STANDARD**



C. A. WILLEY CO.

COLOR GRINDERS

and Manufacturers of Specialties in

CARRIAGE, AUTOMOBILE AND CAR

PAINTS

COLORS, VARNISHES, ETC.

HUNTER'S POINT, NEW YORK CITY

Skewed Shaft Couplings

Regular or Oval Patterns
For High Arched Axles

Furnished in rights and lefts for any height of arch. Oval Axle
Clips $\frac{5}{8}$ or $\frac{3}{4}$ width to match Oval Couplings. Bolts, Clips,
Couplings, Carriage Hardware and Special Forgings

Catalogue "H" and Prices on Application

COLUMBUS BOLT WORKS, Columbus, O.

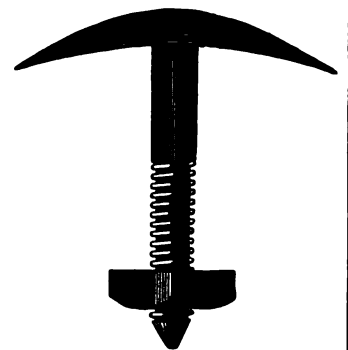
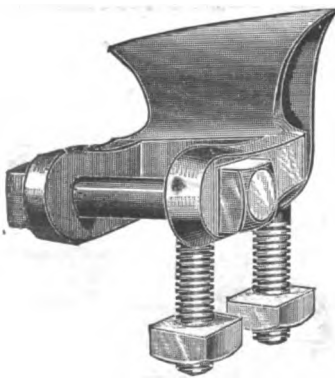

The Hub



TRADE NEWS PUBLISHING COMPANY
24-26 MURRAY ST. NEW YORK.

HOTEL DENNIS

ATLANTIC CITY, N. J.



Directly facing the sea and overlooking the famous boardwalk.

Every room connected with private bath or having hot and cold running water.

Within one square of Young's Million Dollar Pier, where Carriage Builders' Exhibit for 1914 Convention is held.

Capacity 600.

Walter J. Buzby

HOTEL CUMBERLAND

NEW YORK

BROADWAY AT 54TH STREET

Near 50th St. Subway Station and 53d St. Elevated.

"Broadway" cars from Grand Central Depot pass the door, also 7th Avenue cars from Pennsylvania Station.

New and Fireproof

Best Hotel Accommodations in New York at Reasonable Rates.

\$2.50 with bath and up

European Plan

All Hardwood Floors and Oriental Rugs

Ten minutes' walk to 40 Theatres

Excellent Restaurant
Prices moderate

Send for Booklet



HARRY P. STIMSON, Formerly with Hotel Imperial

Only New York Hotel window-screened throughout

JOHN W. MASURY & SON

Originators of

Superfine Coach and Automobile Colors

Acknowledged the Standard for Fifty Years

AND MANUFACTURERS OF

Fine Carriage and Automobile Varnishes

New York,

Chicago,

Minneapolis,

Kansas City

Sidney Metal Buggy Seats and Metal Bodies

The Best in the World

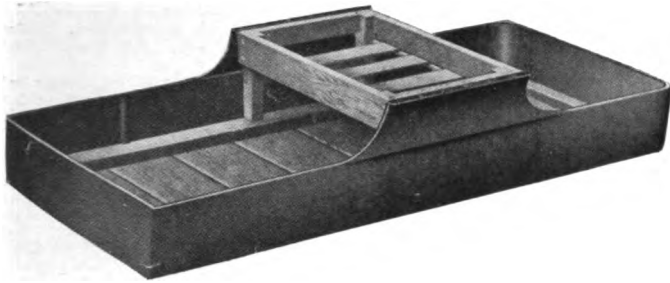

The Largest and only exclusive Metal Buggy Seat and Metal Bodies builders in the world. Daily capacity expectancy, 400 seats.

We know how to make them. Your own design if desired

We are adding new and attractive styles for 1915 to an already large line of Metal Seats, which will be ready for your approval in a few weeks. Write for catalog and prices.

We use no solder

Before contracting your wants in Buggy Seats for 1915 write us to see the largest line of Metal Seats.

Every Seat Guaranteed.. Have stood the test for years

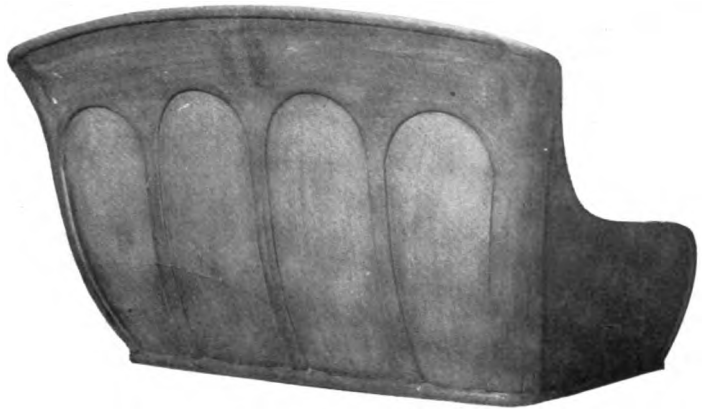

The Sidney Manufacturing Co., Sidney, Ohio

WILCOX FINE FINISHED FORGED

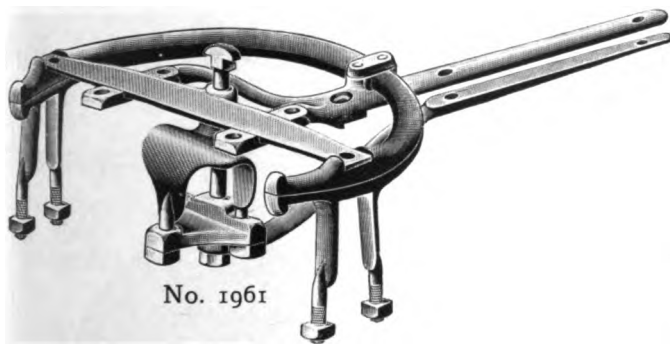

Carriage Hardware and Gear Irons

Write us for Catalogue No. 11B

The D. Wilcox Mfg. Co.

MECHANICSBURG,
CUMB. CO., PA.



ATLANTIC CITY'S Finest, Largest and Most Popular Hotel at Moderate Rates
HOTEL MONTICELLO

5 Minutes Walk From Million Dollar Pier
 Headquarters for Carriage Builders' Convention
 Kentucky Ave., Near Beach and All Attractions. Modern, High Class, Home-like; Capacity 500. An Exceptionally Good Table.

Choice, well furnished rooms, private baths, brass beds; elevators to street level; splendid location, opposite finest bathing section. Guests can dress in hotel for bathing. Unusually attractive lobby, parlors and reception rooms, spacious, cool verandas. Three dining rooms, courteous, white help. Good music; frequent entertainments; automobile coach meets trains. An illustrated, descriptive folder of the house mailed free on request. Hotel is under liberal ownership management; 10th year; same house. Open all year. Rates, \$2 up daily. American plan. Write now for reservations. Any further particulars desired cheerfully furnished.

Address A. CONRAD EKHOLM, Private Office,
 Atlantic City, N. J.

Kindly mention The Hub.

SHELDON AXLES AND SPRINGS

For Horse-Drawn and Power-Propelled
 Vehicles of All Kinds

JUST ENOUGH BETTER THAN OTHERS TO BE NOTICEABLE

When you specify "*Sheldon*" you are not experimenting with experiments, but are getting Axles and Springs with years of manufacturing experience back of them—Axles and Springs that are selected for important work where conditions make reliability supremely important

SHELDON AXLE COMPANY - WILKES-BARRE, PA.

LARGEST AXLE AND SPRING FACTORY IN THE WORLD

PORTER'S BOLT CLIPPERS

"Easy" "New Easy" Allen-Randall



To Cut 5-16, 3-8, 1-2, 5-8, 3-4 inch.

H. K. PORTER,

EVERETT, MASS.

Richard Eccles Co., Auburn, N.Y.

Manufacturers of

Forgings: Carriage, Wagon, Automobile' Special

Send for Catalogue No. 18;

Also Catalogue of Special Automobile Forgings



Please mention "The Hub" when you write.

LIMOUSINE STEEL SEAT

READY FOR THE SEASON OF 1915

NOT A WELD, JOINT OR SEAM—ONE PIECE; ALL STEEL

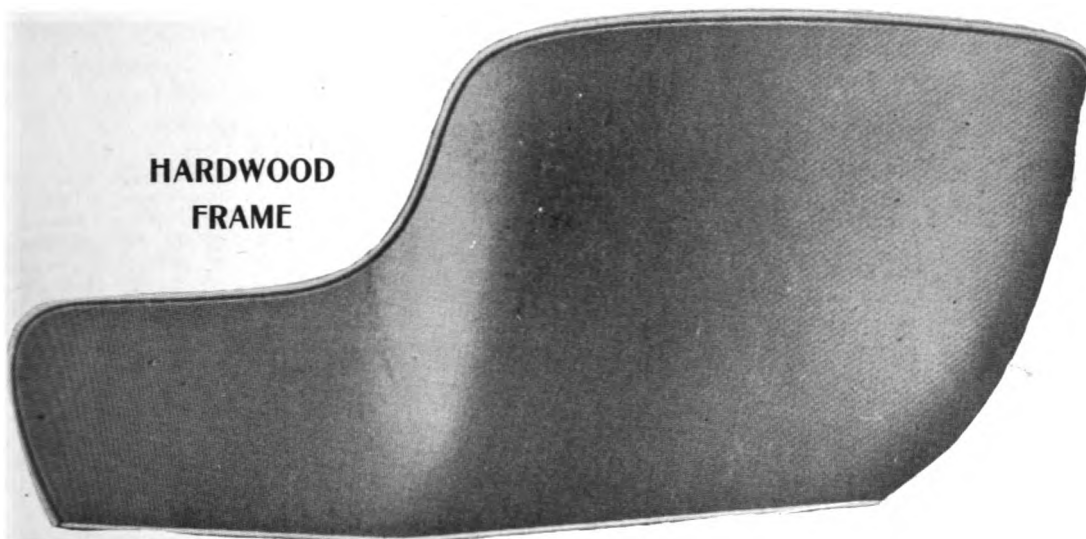

HARDWOOD
FRAME

SEND
FOR
OUR
CATALOGUE

DESIGNED AND MANUFACTURED EXCLUSIVELY BY US

METAL PIANO BODIES

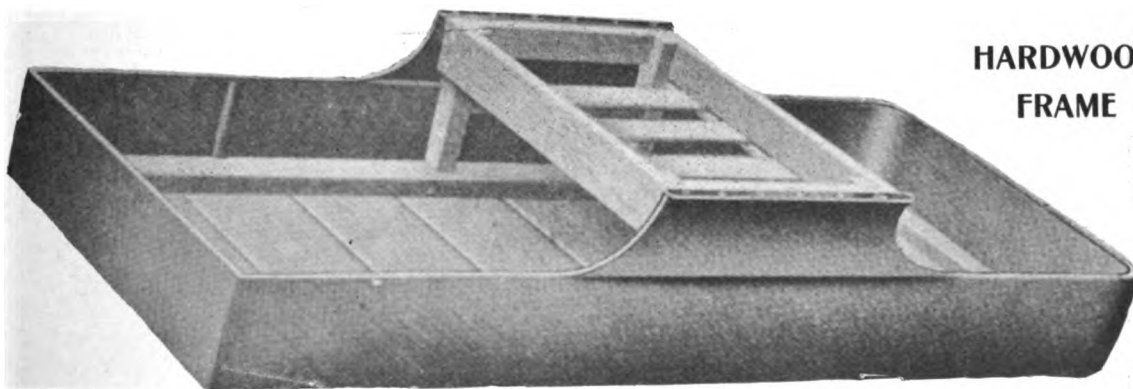

HARDWOOD
FRAME

MADE IN
6 1/2 OR 7 IN.
PANELS.
AT A
PRICE

TAKE THIS OPPORTUNITY TO INQUIRE

CENTRAL MANUFACTURING CO. CONNERSVILLE, IND.

Quality
Is
Economy

*Quick Motor Car Gear Special
does exactly what they want*

Motor Car and Carriage Owners
are delighted to see
that it is untouched
by the chemical action of soap.

They are enthusiastic over
the way it holds its luster
after mud and grease
are cleaned off it.

They are perfectly satisfied
with its resistance to grits
and vibration; with its endurance
of heat and cold.

The Varnish
That Lasts
Longest

Murphy Varnish Company

FRANKLIN MURPHY, President

Associated with Dougall Varnish Company, Limited,
Montreal, Canada

NEWARK
AND
CHICAGO

THE TRADE NEWS PUBLISHING CO. OF N. Y. Publishers of THE HUB

J. H. WRIGHT, *President* G. A. TANNER, *Secretary and Treasurer*
24-26 MURRAY STREET, NEW YORK

Other Publications of Trade News Publishing Co.:

HARNESS (monthly).....per year, \$1.00
AMERICAN HARNESS AND SADDLERY
DIRECTORY (annual).....per copy, \$5.00

THE HUB is published monthly in the interest of employers and workmen connected with the manufacture of Carriages, Wagons, Sleighs, Automobiles and the Accessory trades, and also in the interest of Dealers.

Subscription price for the United States, Mexico, Cuba, Porto Rico, Guam the Philippines, and the Hawaiian Islands, \$2.00, Canada, \$2.50, payable strictly in advance. Single copies, 25 cents. Remittances at risk of subscriber, unless by registered letter, or by draft, check, express or post-office order, payable to the order of THE TRADE NEWS PUBLISHING Co.

For advertising rates, apply to the Publishers. Advertisements must be acceptable in every respect. Copy for new advertisements must be received by the 25th of the preceding month, and requests to alter or discontinue advertisements must be received before the 12th day of the preceding month to insure attention in the following number. All communications must be accompanied by the full name and address of writer.

FOREIGN REPRESENTATIVES:

FRANCE—L. Dupont, publisher of *Le Guide des Carrossiers*, 78 Rue Boissiere, Paris. Subscription price, 15 francs, postpaid.

GERMANY—Gustave Miesen, Bohn a Rh. Subscription price, 12 marks, postpaid.

ENGLAND—Thomas Mattison, "Floriana," Hillside avenue, Bitterne Park Southampton. Subscription price, 12 shillings, postpaid.

Entered in the New York Post Office as Second-class Matter

Trade From a Traveler's Point of View

In going about that somewhat misty locality called the middle west, an observer has called at the big and little factories to an extent sufficient, we suppose, to give a line on how business is shaping up.

The conditions in the smaller buggy factories seemed to be rather good. The work in the spring and summer has been moving freely, and the prices appeared to be, at least, sufficient; no price ever satisfactory from a maker's point of view.

These smaller factories were supplying the anticipated needs of the dealer in radii that were not many miles from each factory, as their limits, and some of the thinkers seemed to find in this a reason for the good business.

With the leviathan concerns, where the output must be prolific to make the turnover satisfactory, the news was not so good.

It seemed to be harder to market buggies when the field comprised almost the four points of the compass.

It looked as if there were going to be more of this class of manufactures on hand at the season's close than is comfortable to have around.

We mention these two trade aspects more in a spirit of curious interest than not.

It seems that the smaller, well-in-hand factory, with not too much product to be absorbed, is not so liable to become product soaked as the big quantity proposition, when the power of absorption of the country is not at its highest.

The class of work does not differ materially, if at all, in either case. The price corresponds closely in both kinds of distribution, but the smaller business, closely and well handled, seems to be a neater proposition than the very big outfit, in some conditions of trade.

So many are obsessed by the quantity idea in all classes of manufacture that it would seem the good points of the smaller business are overlooked.

What the sudden checking up of business may have done to both classes of builders is something on which we have no data at the time of going to press, but without question the pressure of the brakes must be in operation on all the wheels rather than on some of them only.

The War Movies

At the moment the great upheaval in Europe is the uppermost topic, and its angles are almost confusing. The humanitarian, the peace professional, the man in the street, and lastly the merchant and manufacturer, seem to have opinions that are everything by turns and nothing long.

It is so self-evident to say that its outcome no one can forecast, that all catch themselves repeating that very thought. Whatever way it ends, the map of Europe will have to be redrawn, and it may also be necessary to entirely reconstruct the lines of world trade; it probably will be. The very important trade changes will come in colonial traffic. Many of the colonies built up, stolen or acquired by other enterprising means will change owners, and as it looks now, Germany will be a great loser in this direction, come what may, otherwise.

We are looking wistfully at present for what is to fall into Uncle Sam's market basket. If he goes to market abroad, as would seem he ought to do, he should come home with an assortment of world trade that would last him for years. This opinion is the one unanimous idea discoverable, but how Uncle Sam is to go about it on his journey is causing all the doctors much thought, and there is a confusing difference of opinion.

It is quite like picturing a man with an appetite standing before a table loaded with all that is desirable, and not knowing just where to fork in to the provender.

To be sure, the opportunity is still young, and much preliminary work must be done before a start can be made. There is hardly a trade that can be classified that does not see its possible gain vaguely, but no coordinated move in any direction has yet been made. Perhaps the time isn't quite ripe.

From our own point of view, we only see opportunities to the south of us that are really worth while in the horse vehicle industry, but as the chances are not new, we have hard work to pump up enthusiasm or faith that they will be availed of.

The automobile, on the contrary, has already exploited the export field where the pickings seemed to be the richest, and those fields are just now war zones.

But the accessory or parts makers may see new and brilliant chances.

Has the Cyclecar Squashed?

We hear all sorts of mixed reports from makers of car parts that the rage for the cyclecar was of short duration, and that the future prospects for a vehicle of this kind are not rosy.

The explanations are almost as numerous and different as the thoughts of men, but the main conclusion seems to be derived from the fact that the call for parts with which to assemble this class of vehicle has fallen off very abruptly.

It was gathered from most of the talk that \$395, or even \$385 for the cyclecar and the light car was too close to the \$440 of a "real" automobile to create a desire for the newer type. Also it was said that a prolific Detroit factory was ready to shell out the automobile goods at any price that would be competitive, if it was shown that the cyclecar was making ground, and that plans were ready and pigeonholed for a cyclecar if such should be indicated as a trade winner.

We don't know how this is, as our information comes from only one side, but we do know that street observation fails to discover as many of the new type of vehicle as we think ought to be in evidence if the idea is popular and the car is something that is worth the figure put upon it.

The low-priced automobile is everywhere seen, and so plentifully that it seems almost to the exclusion of the higher-priced type, hence we conclude the light car maker or the cyclecar must have fallen down somewhere in the fitness of the product, as there appears to be plenty of money ready for something low in price, but that will stand up.

There is nothing in the vehicle line more meretricious in design and in looks than the one low-priced car at present so popular. There is hardly a body on a car with less to commend it from any point of view: there is hardly a car whose springing so soon makes the rider aware that Jordan is a hard road to travel—but it goes, and goes without much annoyance to the driver, therefore it is as plentiful as blackberries in August.

We had supposed that the cyclecar would duplicate this success, but it seems not to have done so.

The Tri-State Association

It would seem that the "Try"-State Alliance that has been such a source of well-being to Kaiser Rathbun, is being attacked in its flank by the forces of the Implement Age with suggestions that it would be well to split up the territory and thus secure more efficient state, and even still more local, organizations. The Age puts no censorship on its plan of campaign, but lines it out in the open.

General Grant Wright, at the head of the Eastern Dealer army (a most amusing ally of the Age, all considered), has thrown the forces of his attack at the Kaiser's center, hit him under the midriff, so to speak, and plainly uncovers the real position of the Kaiser and the Fried-State, that has been so long and so successfully trying the fat out of the manufacturer-exhibitor.

As General Wright knows all about it, we will just copy his burning words:

The Tri-State has been an injury rather than a help to the cause of dealers' associations, for their effort has always been mapped around a show, at which manufacturers have been maced for space and charges, the profits from which have not been used in the cause of the dealer.

No dealer association will ever succeed that does not cooperate and work with the manufacturer, and this the Tri-State has not done, but instead it has used its force to compel manufacturers to spend money that they did not receive returns on.

The Tri-State was originally formed by a trade paper in Cincinnati for two purposes only. One to help their advertising, and the other to make money from the exhibit space sold. The so-called sessions of the convention were jokes.

When the trade paper could no longer handle the graft, some dealers took it up, but there has never been a convention of the Tri-State that merited the name.

Ohio ought to have an organization of dealers for the right purpose, and that would be the education of the dealers to the end that they would benefit as would the manufacturers and jobbers. This might put Secretary Rathbun out of a job, but it would benefit every other part of the industry.

Storm Buggies

We have exploited the popular storm buggy this month. We think it will be most interesting to readers, whatever their status, to compare the variations of one style of vehicle.

This construction is as distinctive an American type as the buggy itself. We call to mind no country where its like is to be found.

And aside from this the type is, on its merit, a very serviceable, comfortable and weatherproof one that is a credit to its originator whoever he may have been.

A Paragon of a Dealer

The National Implement and Vehicle Association has issued a little book, just a little one, and it contains "a few facts about agriculture" that the association Bojum thinks the dealer ought to absorb.

We have read along until we find this:

The dealer should know the farmer's factory; he should understand its construction; the phenomena of plant life; how to manage farm operations in order to secure the best results

and the best methods to pursue in order to maintain the fertility of the soil.

Until we found that this is what the dealer should know, we had supposed he was a mere ordinary man, very ordinary in most instances, but it is not true. He should know according to the association what Darwin, Prof. Law, all the departments of all the kinds of agriculture, and all the professors of agronomy, have not yet found out to their satisfaction. We except from the list Darwin and Law, as they are where all is known.

It is such sapient advice uttered by those who are not careful of their words, and less careful of their thoughts, that makes the kindly efforts of the promotor of the public good seem so much like a first cousin to the faithful brute that spoke out aloud to Balaam instead of publishing a little book.

Sick 'Em Tiger!

It seems the Moline Plow Co., that has so many irons in the fire, has determined that the fire is hot enough to heat at least one more.

Like all those many-jointed big concerns, the plan has been to market product through jobbing houses (incidentally the jobbing house has also been the private property of the main company).

In this way the Moline outfit has been accustomed to strew its buggies around among the dealers, but an additional stunt is now effective. It is to attack the dealer direct in place of trying to turn his flank. Probably the catalog house buggy factory with some left over for direct dealers trade has not been the most comfortable competition in the world, so the Tiger Vehicle Co. has been thought of and is now out of its lair and prowling around the dealer jungle for direct trade. Perhaps Hercules in his seven labors, never met a Tiger.

Apparently Going Down

A concern in Fenton, Mich., is out with a cyclecar for \$285. This is the low price mark so far, but the cagey maker adds that equipment will cost \$100 extra, which puts him back in the \$385 class with the others. The tendency, however, is towards the \$250 mark.

OUTLOOK ACCORDING TO A MANUFACTURER

That the business opportunities offered to American manufacturers as a consequence of the European war are no fanciful speculation, but actual fact, is already shown by the correspondence received by many manufacturing concerns. At first glance, the automobile trade would appear to be one of the most likely to suffer from the effects of the European situation, but even in the motor car line signs of the world-wide demand for American made cars are beginning to be conspicuously in sight.

English and French colonies are already showing an interest never shown before in American made cars. It's too early, of course, for receiving the first reports from distant territories such as India, Australia or South Africa, posterior to the war declaration, but inquiries from nearby territories such as the West Indies, right after the war was started, are most significant and hopeful.

A characteristic inquiry received from a Scandinavian country and written by the managing director of one of the most important automobile concerns clearly expresses the situation in the following terms: "We have been dealing in French cars exclusively, but owing to the war and the following late deliveries, either I personally or my company will take up an American car."

In the automobile line, the situation developed by the European conflict will not only bring a large increase in trade, but it is likely to cause a change in the quality and price of the cars exported. It is a well known fact that, so far, the only American machines that have found their way abroad are the low and medium-priced makes—the average invoice price for export cars is below \$1,000—while very few expensive American cars are sold abroad, with the only exception of Canada.

ST. LOUIS TAKES ITS PEN IN HAND

S. D. Capen, president of the Business Men's League of St. Louis, has forwarded to Secretary of Commerce Redfield replies received by the league from St. Louis firms respecting business conditions, also opinions as to whether a pilgrimage to Washington to see President Wilson was thought advisable.

P. B. Ebreuz, of Reliance Buggy Co., spoke right out. We quote:

"Replying to your letter requesting our opinion as to the advisability of a committee going to Washington to confer with the President on present business conditions and pending legislation.

"We believe this idea is being overworked, as Mr. Wilson is receiving and has received voluntary delegations daily, who have this one purpose in view. While the President is willing and anxious to lay his views and to some extent his plans before the business men of the country and any others who may be interested, the sending of a committee to Washington without invitation from the President himself would not meet with our approval.

"Our business has been pleasantly normal this season. We have just completed ten months of our fiscal year with very satisfactory results so far. From our point of view, the feeling on the part of some business men that business is unsettled is not borne out by our own results. We are inclined to believe that a great deal of this calamity stuff is imaginary and mischievous.

"If his business is unsatisfactory to the business man, the most effective remedy is to dig in and remedy it. We stated that our business is pleasantly normal. We can truthfully add that our business is increased almost 20 per cent. to date over last year.

"Sitting around dinner tables criticising the government, and the President in particular, on subjects, the fundamentals of which we might know little about, did not bring these results, but, instead, consistent work directed in the field we cover, and we are inclined to believe that this remedy is in the hands of every business man if he will pay less attention to the troubles of the railroads and leave the affairs of the government in the hands of those who are placed there to look after them."

MR. MAXIM MAKES A FORECAST

Maxim, the inventor of silencers for guns and things, has been asked by a journal how about the light car. He, with extraordinary foresight, fully equal to that of the man in the street, says it is coming and it will be priced at \$250. Incidentally, but as a matter of no particular moment, we might range ourselves about eighteen months ahead of Maxim in the forecasting business, only our figure was and is \$200. We give parts of the Maxim views:

"I think we are decidedly in a position to be able to revise our automobile engineering knowledge so as to produce a commercially successful light motor car. In looking forward from

a standpoint of established fact to what seems to be a logical possibility, we must take past history as our chief guide. Let us briefly analyze automobile engineering history as it relates to this particular question:

"We begin by concerning ourselves exclusively with what was necessary in order to "keep the machine going," regardless of any other consideration. Breakdown was the great nightmare before us. Cost to manufacture and market were subordinate questions.

"Then came the middle period, when the most skillful of us saw clearly beyond dispute that we had the knowledge of how to produce a machine which would "keep going indefinitely." This conviction developed a new school of automobile engineering. It was evident that with this knowledge of how to produce a motor vehicle which could be absolutely depended upon inspired certain of us to see how cheaply we could produce this reliable motor car. The low price astonishingly successful vehicle appeared forthwith. This is where we stand today.

"Now, there are certain of us who realize two big facts—that we have the knowledge necessary to build a thoroughly reliable machine, and that we also have the knowledge necessary to build this machine and sell it for \$500. This has inspired certain of us to take the third step: To alter our original engineering practice enough to accommodate the new manufacturing possibilities, and to produce a motor vehicle for \$250. There are a lot of us who are convinced that this can be done, just as there were some of us in 1903 who were convinced that a successful car could be made and sold for \$500.

"This idea is fixed in men's minds, and we know that once an idea is positively fixed there will be a man come along who will carry out the idea successfully. The light cheap car will come, and nothing can hold it back, in my judgment."

A CONSIDERATION OF THE STORM BUGGY

We illustrate a large and comprehensive "line" of storm buggy styles in this August Hub.

It is a good time for all interested to take stock of what the builder has to offer, to compare, classify, set one against another for style and workmanship, and conclude what one or ones will best meet trade conditions in any stated locality.

There has been a marked advance in volume of manufacture of this interesting vehicle. It has emerged from its first state of crudity into a finished state that is to all intents storm proof, and comfort has been thrown in as good value measure.

While the type must, of course, discover a certain sameness of line and design, yet an inspection of detail will show many individual features that carry merit that is particular and personal. For this reason the exhibition ought to be full of interest for readers.

The type is American, out and out, the comfort is Yankee through and through; and the vehicle is useful to such extent that there is no substitute for it.

It is more properly a weather-proof buggy, because it contemplates protection from the temperature as well as from the storm. It is a "comfy" vehicle at a time when such ability is most highly appreciated. There is no "just as good" vehicle when the buyer wants what it gives. The open buggy is a joke at the time the weather-proof buggy is an argument.

From the point of view of the dealer who is mainly interested in the storm of dollars that come to him by reason of its sale, we quote what a writer has to say as to his idea of the right way to exploit its sale:

"Dealers who have had considerable experience in handling storm-proof buggies have hit upon a plan of procedure that pays handsome returns on the money invested. These dealers say that the way to sell storm buggies is to partition off a space in the front of the salesroom large enough to be suitable for a comfortable rest room with easy chairs and a sofa and as much of a library as it is possible to get together. There should also

be a reading table with a number of the standard magazines and metropolitan newspapers. In this room have a storm-proof buggy full panoplied to go forth in the teeth of the severest storms of winter. When customers or friends come to town in the winter time they are quick to appreciate any attention shown them, and especially so when they are invited to see how it feels to sit in a storm-proof buggy. With a magazine or newspaper in hand they become snugly ensconced out of the range of the bitter winds, and the psychology of the situation is so persistent in its human appeal that the visitors either buy the buggy outright then and there, or they arrange to purchase at a later date.

"Another strong point in favor of storm-proof buggies is that the demand for them comes when business on the ordinary lines is quite, if not altogether at a standstill. During the fall and winter the dealer can push sales on storm-proof buggies, for then is when they are needed most of all. At that time of the year the progressive vehicle dealer should have some strictly seasonable line of buggies to offer his trade, otherwise his buggy business will not show a full order book at the end of the year. Storm-proof buggies afford larger profits than are to be realized from the sale of ordinary buggies, and this should be incentive enough to induce all vehicle dealers to handle them."

All the points made are cogent and money-getting and should be studied along with a consideration of the designs.

It will be noticed that the best buggy builders in the land have mixed in some storm buggy along with the more or less ventilated and open styles that they offer, so the "goods" are necessarily first class all the time.

Each one has thought out his little improvement, and they differ, all, just as the ideas of men may differ who are thinking and working along a given line of thought, but the type persists in all circumstances.

We think what we have gathered together in this issue will be a presentment of great reference value, and ought to be preserved on that account.

It is a rare chance that we offer for a dealer to step into a repository of all the trade, and view, criticise and favor individuals from one type. No fair, no dealer's show, no anything, anywhere offers a similar treat.

FIFTEENTH ANNUAL MEETING FEDERATION CONVENTION TO BE HELD IN CHICAGO, OCT. 13, 14 AND 15—SECRETARIES MEET OCT. 12

The annual convention of the National Federation of Retail Implement and Vehicle Dealers' Associations will be held in Chicago, October 13, 14 and 15. This will be the fifteenth annual meeting. It will be a delegate convention, composed of representatives from the 15 constituent associations.

The Sherman House will be headquarters, and all sessions will be held there.

The annual meeting of the Secretaries' Association will be held on Monday, October 12. This association is composed of the secretaries of the organizations represented in the Federation.

All of these meetings will take place one week ahead of the annual convention of the National Implement and Vehicle Association, the manufacturers' organization.

IMPLEMENT AND VEHICLE SHOWS

National Implement and Vehicle Show, Peoria, Ill., September 4-12.

Tri-State Vehicle and Implement Dealers' Association show, Cincinnati, O., October 19-24.

Iowa Implement Dealers' Association show, Des Moines, Ia., November 30-December 5.

Wisconsin Retail Implement and Vehicle Dealers' Association show, Milwaukee, Wis., December 7-12.

THE HUB STORM BUGGY STYLE PORTFOLIO

LIST OF CONTRIBUTORS

The Butler Co., Butler, Ind.
 Parry Mfg. Co., Indianapolis, Ind.
 Moline Plow Co. (Henney), Moline, Ill.
 Anchor Buggy Co., Cincinnati, O.
 Zimmerman Mfg. Co., Auburn, Ind.
 The Cook Carriage Co., Bloomville, O.
 The Geo. Delker Co., Henderson, Ky.
 C. R. Patterson & Sons, Greenfield, O.
 Harper Buggy Co., Columbus City, Ind.
 T. T. Haydock Carriage Co., Cincinnati, O.
 The Defiance Carriage Co., Defiance, O.
 Seidel Buggy Co., Richmond, Ind.
 Staver Carriage Co., Chicago, Ill.

Luth Carriage Co., Cincinnati, O.
 Page Bros. Buggy Co., Marshall, Mich.
 H. H. Babcock Co., Watertown, N. Y.
 The Ligonier Carriage Co., Ligonier, Ind.
 D. M. Sechler Imp. and Carriage Co., Moline, Ill.
 The Brown Carriage Co., Cincinnati, O.
 The Storm Buggy Co., Fostoria, O.
 Lull Carriage Co., Kalamazoo, Mich.
 Peters Buggy Co., Columbus, O.
 Velie Carriage Co., Moline, Ill.
 The New Columbus Buggy Co., Columbus, O.
 The Mier Carriage and Buggy Co., Ligonier, Ind.

AUGUST, 1914

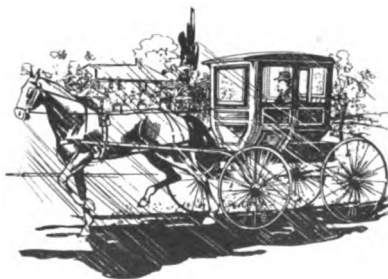

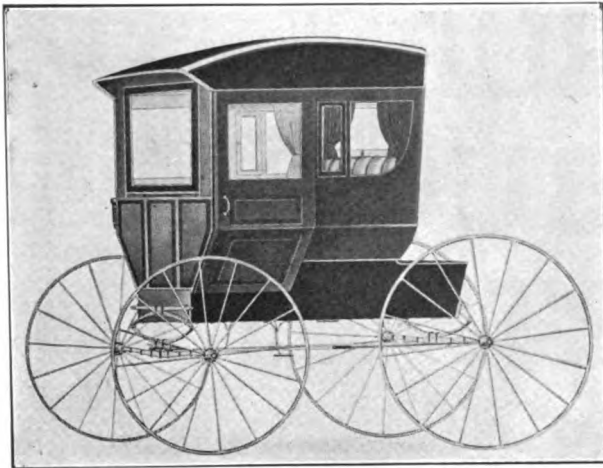

THE BUTLER CO.,
Butler, Ind.



ANCHOR BUGGY CO.,
Cincinnati, O.

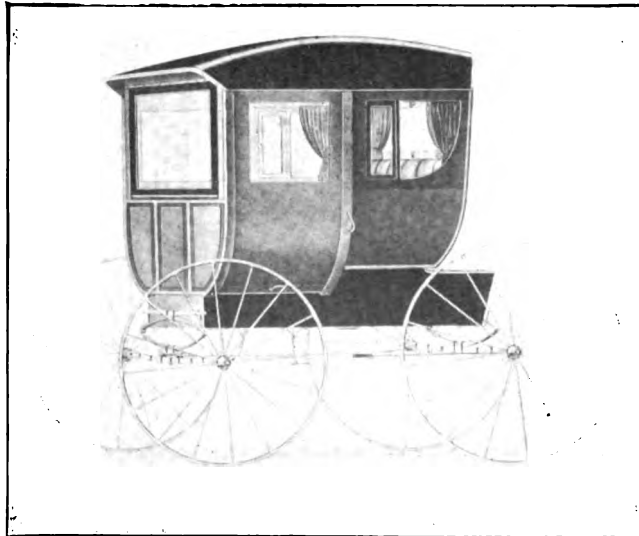

THE BUTLER CO.,
Butler, Ind.

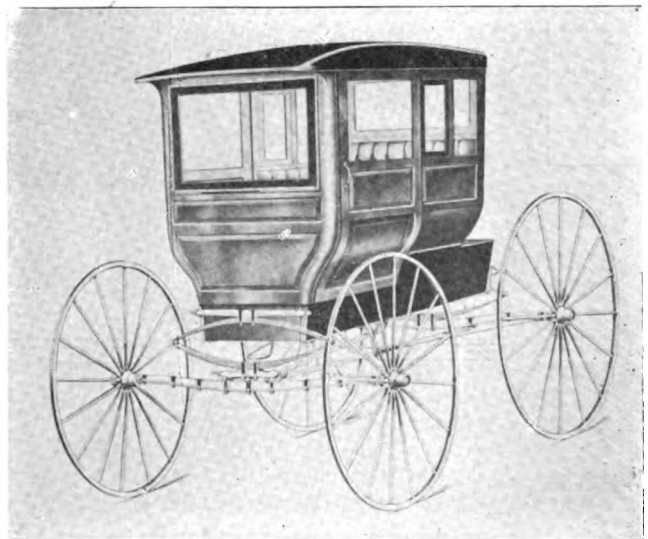

PARRY MFG. CO.,
Indianapolis, Ind.



ZIMMERMAN MFG. CO.,
Auburn, Ind.

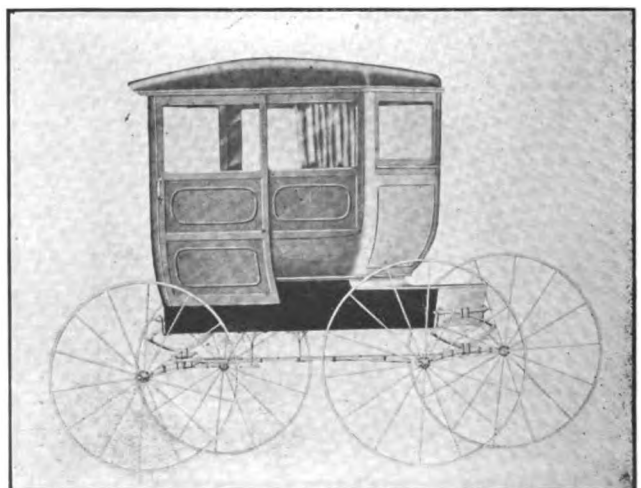

MOLINE PLOW CO. (HENNEY)
Moline, Ill.

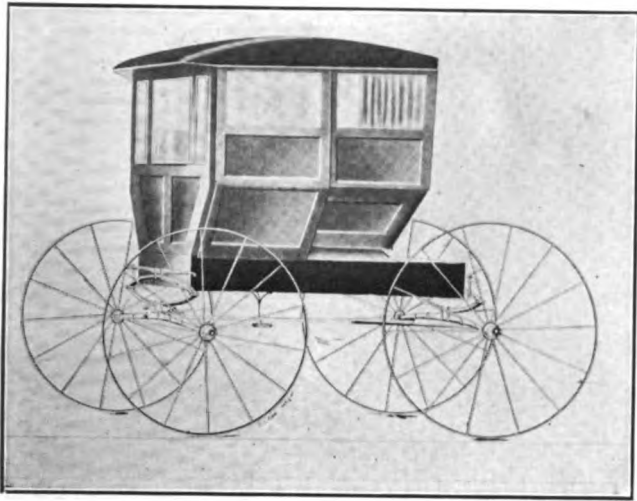

THE COOK CARRIAGE CO.,
Bloomville, O.



THE GEO. DELKER CO.,
Henderson, Ky.

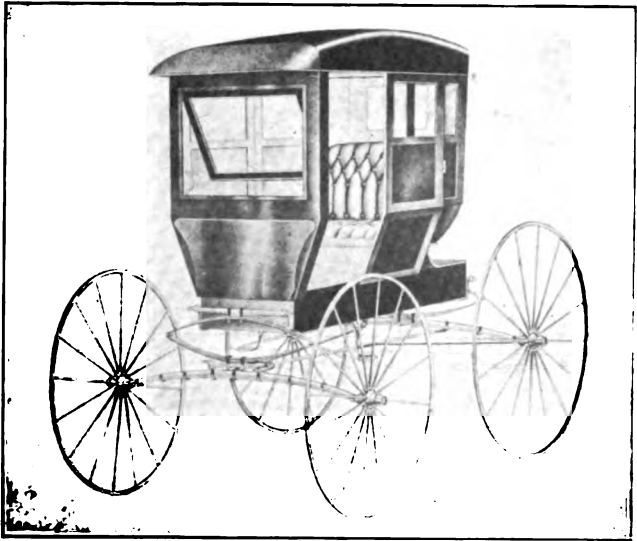

C. R. PATTERSON & SONS,
Greenfield, O.

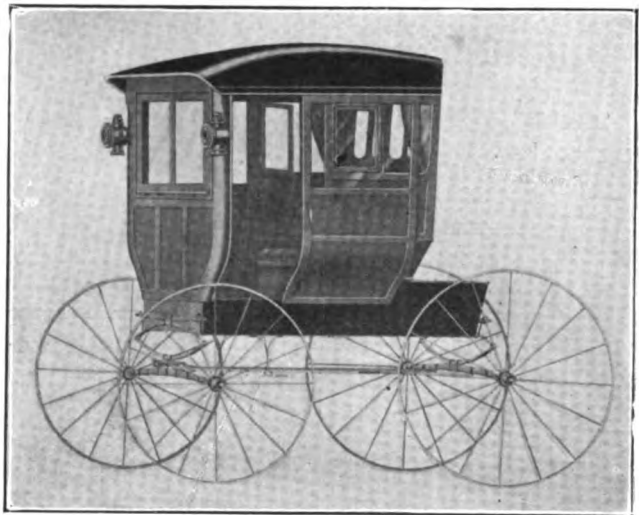

HARPER BUGGY CO.,
Columbus City, Ind.



T. T. HAYDOCK CARRIAGE CO.,
Cincinnati, O.

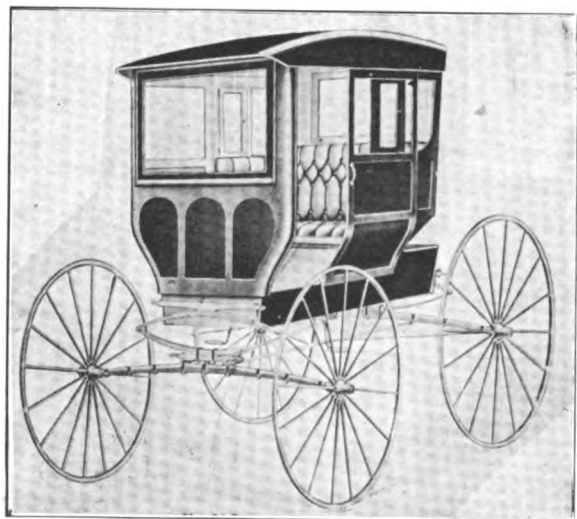

THE DEFIANCE CARRIAGE CO.,
Defiance, O.

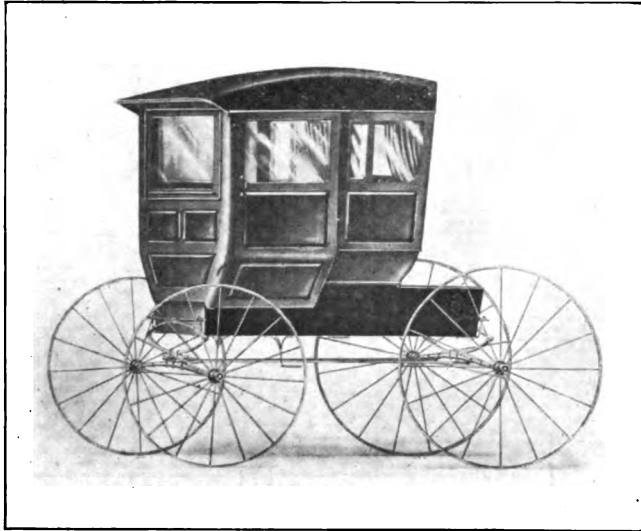

SEIDEL BUGGY CO.,
Richmond, Ind.

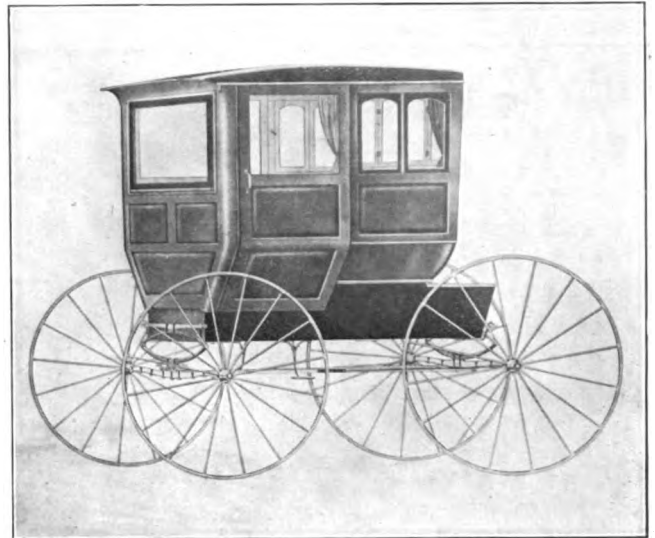

SEIDEL BUGGY CO.,
Richmond, Ind.

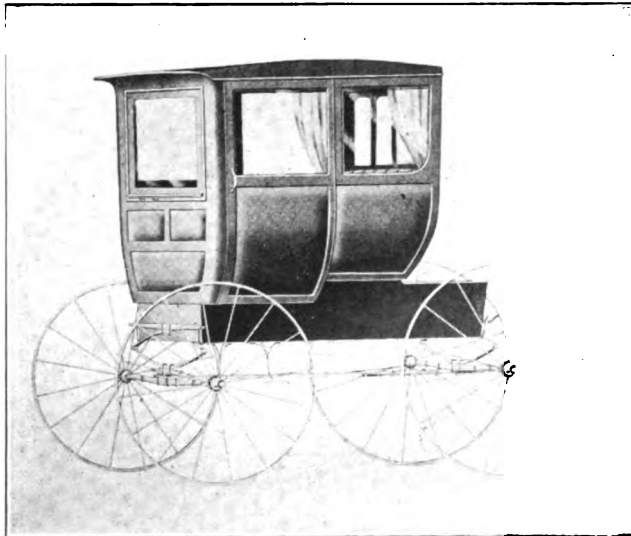

SEIDEL BUGGY CO.,
Richmond, Ind.



STAVER CARRIAGE CO.,
Chicago, Ill.

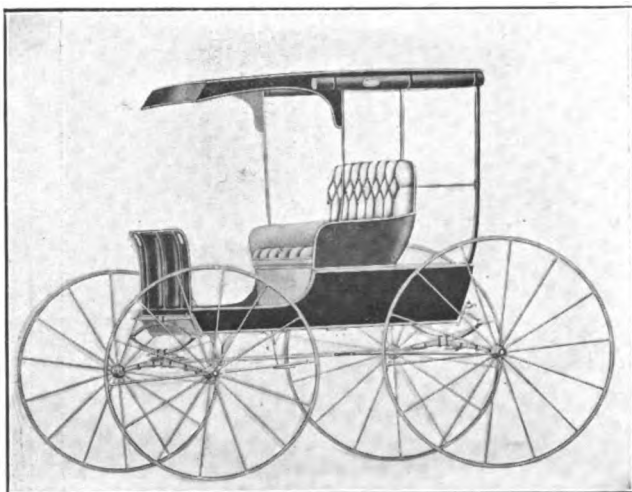

LUTH CARRIAGE CO.,
Cincinnati, O.

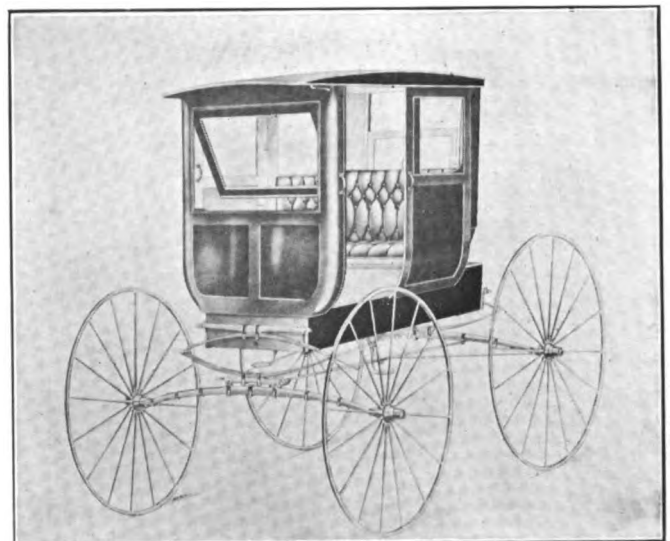

LUTH CARRIAGE CO.,
Cincinnati, O.

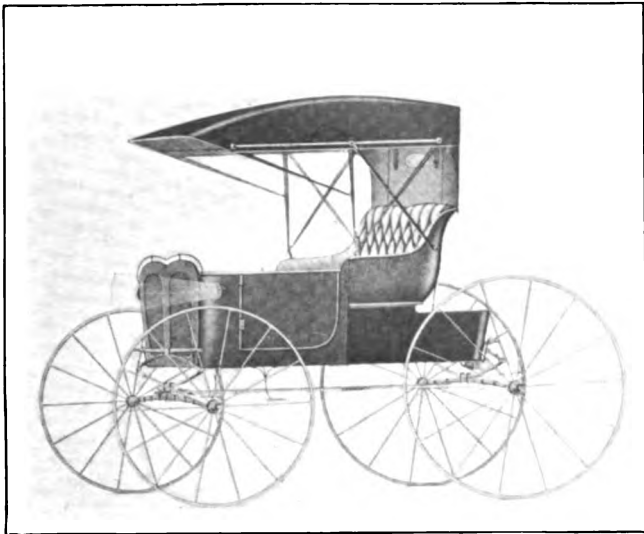

PAGE BROS. BUGGY CO.,
Marshall, Mich.



PAGE BROS. BUGGY CO.,
Marshall, Mich.



H. H. BABCOCK CO.,
Watertown, N. Y.



THE LIGONIER CARRIAGE CO.,
Ligonier, Ind.

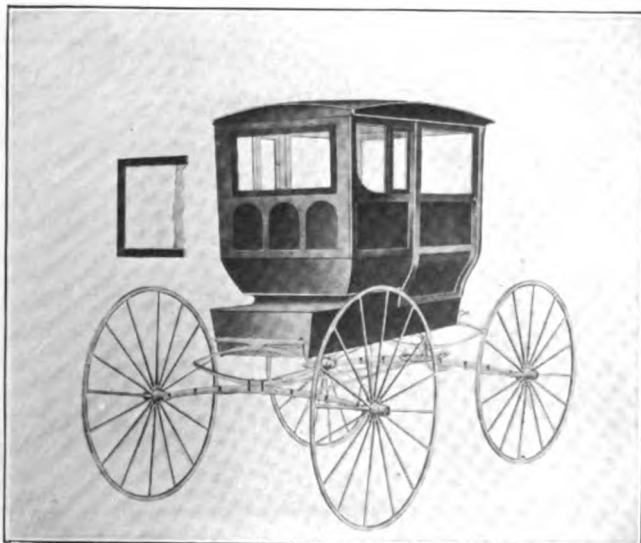

THE BROWN CARRIAGE CO.,
Cincinnati, O.

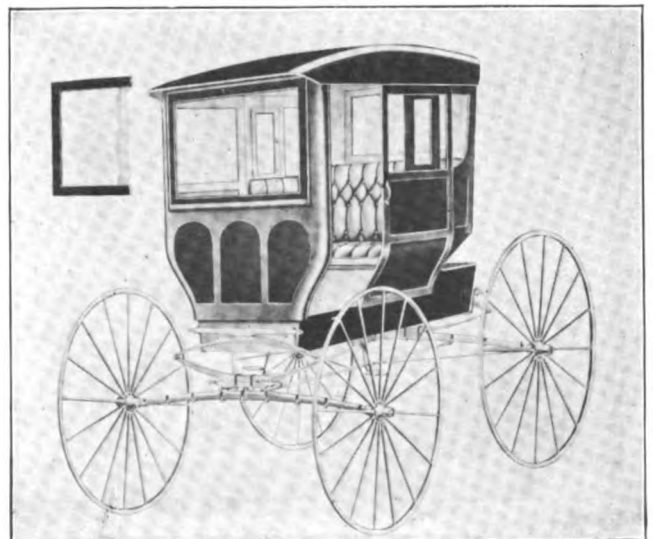

THE BROWN CARRIAGE CO.,
Cincinnati, O.



LULL CARRIAGE CO.,
Kalamazoo, Mich.

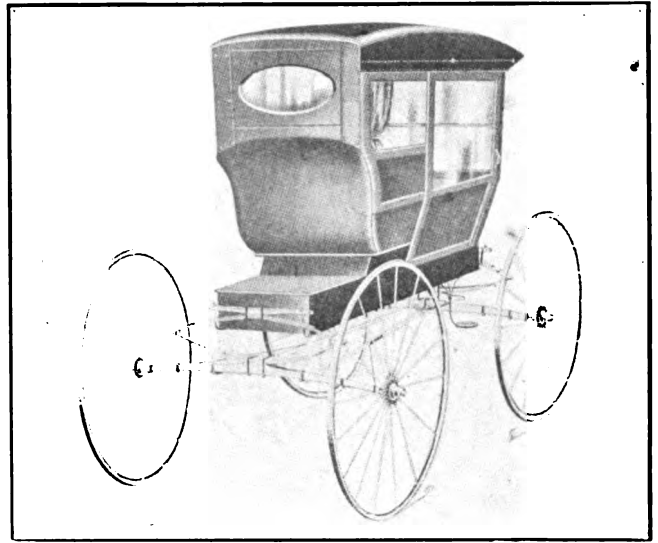

THE STORM BUGGY CO.,
Fosteria, O.

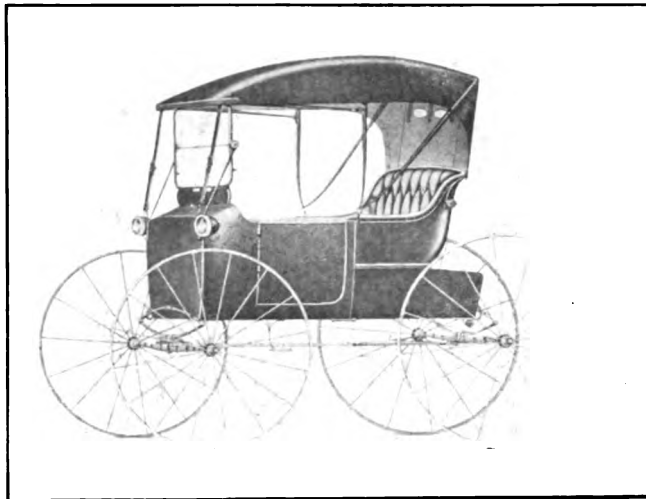

D. M. SECHLER IMP. AND CARRIAGE CO.,
Moline, Ill.



THE STORM BUGGY CO.,
Fosteria, O.

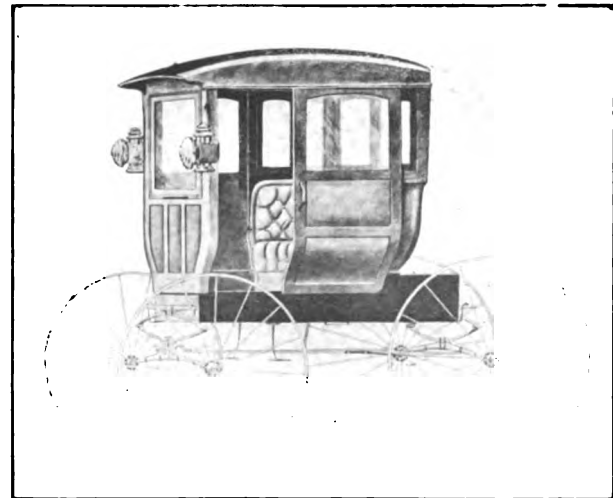

PETERS BUGGY CO.,
Columbus, O.

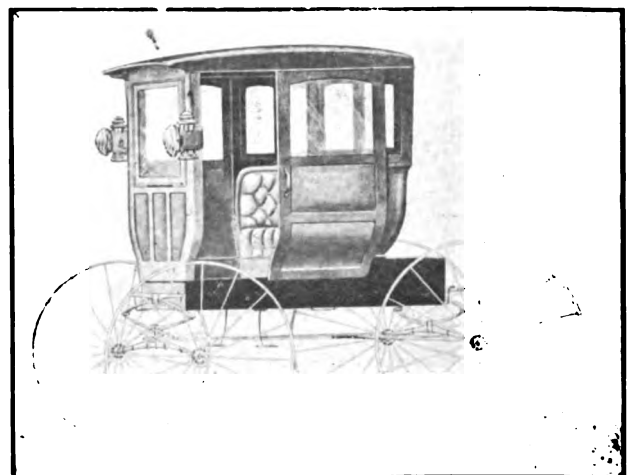

PETERS BUGGY CO.,
Columbus, O.

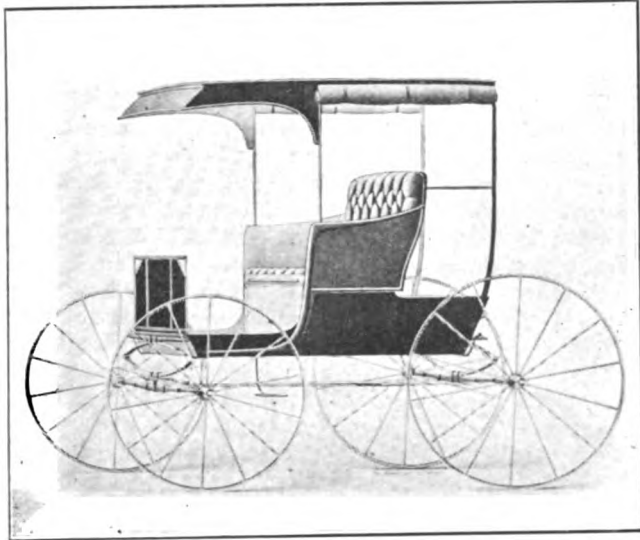

THE NEW COLUMBUS BUGGY CO.,
Columbus, O.

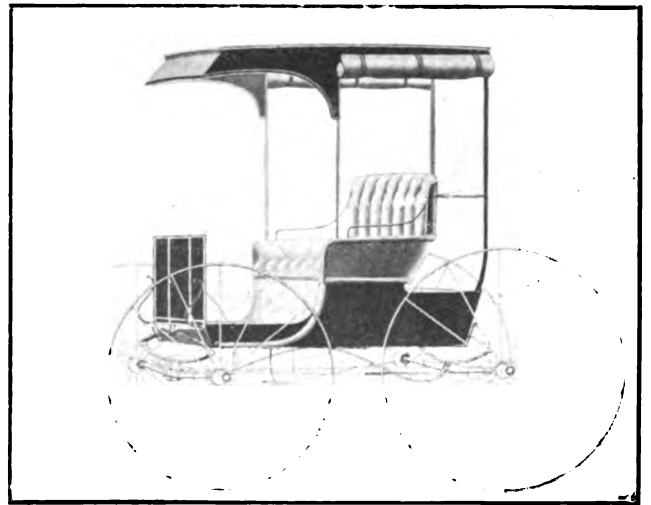

THE NEW COLUMBUS BUGGY CO.,
Columbus, O.

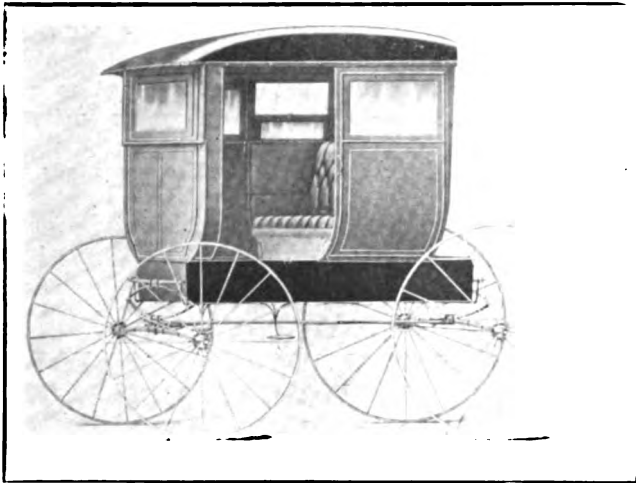

VELIE CARRIAGE CO.,
Moline, Ill.

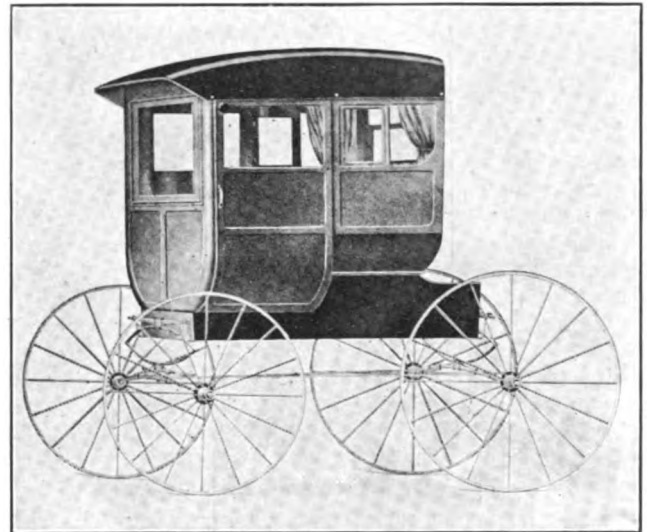

THE MIER CARRIAGE AND BUGGY CO.,
Ligonier, Ind.

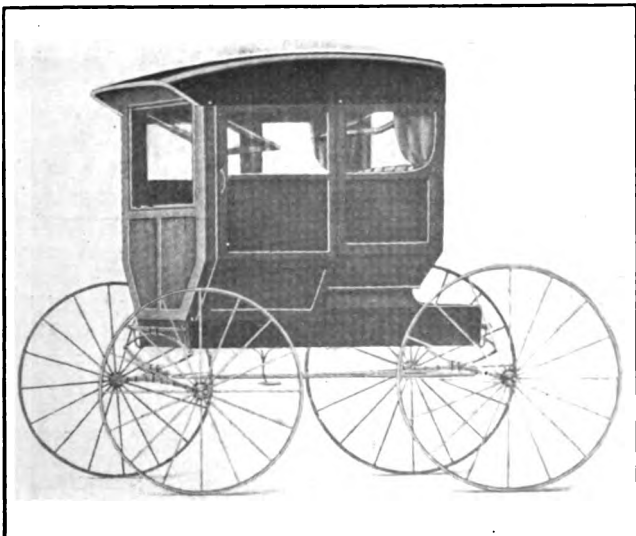

THE MIER CARRIAGE AND BUGGY CO.,
Ligonier, Ind.

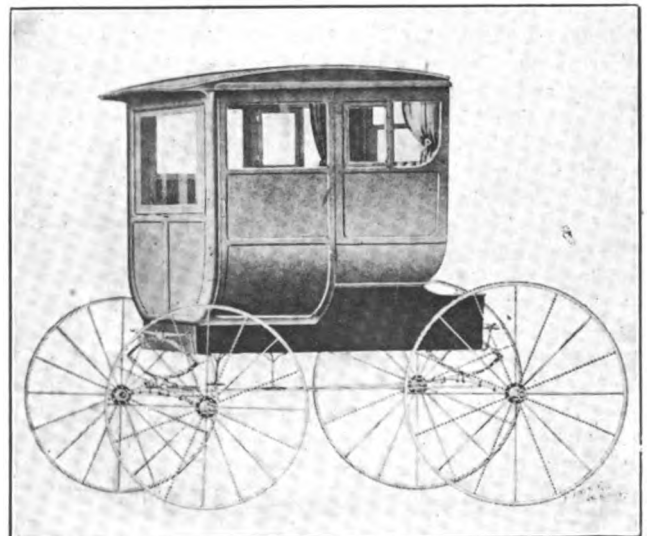

THE MIER CARRIAGE AND BUGGY CO.,
Ligonier, Ind.

PUSHING FOR GOOD ROADS IN CONNECTICUT

An urgent appeal to the business men and taxpayers of Connecticut to assist in solving the highway problem of the state is being made by the Connecticut Good Roads Association, which has begun an energetic campaign to secure the construction of permanent roads.

In a circular letter issued from its office in New Haven, the association says that although good roads are a necessity and pay a large percentage of profit, the highway appropriation, which is the largest on the list, is in danger of being reduced unless business men take concerted action.

"In the trunkline system of Connecticut," says the letter, "we have 1,420 miles of highway. On October 1, 1915, a total of 900 miles . . . will have been improved. . . . This leaves 520 miles uncompleted. . . . Unfortunately, only a very small part of the 900 miles improved has a hard surface. The greater part of our roads are water-bound macadam. As long as we maintain water-bound macadam we shall have an annual expense of \$1,000, or \$1,200 a mile for repairs. If another 500 miles of water-bound macadam is built, the repair expense alone will be tremendous. Under present day traffic water-bound macadam is the most expensive road that can be built, if original cost and maintenance are both considered."

The state highway commission has asked for an annual appropriation of \$500,000 for renewals and reconstruction of trunk lines and equal amount for trunk-line repairs, all to be used, wherever necessary, in placing a hard surface of some kind on the road.

"This plan will result in an important saving," continues the letter, "as every mile of hard surfaced road built will cut down the repair account. A concrete pavement six inches thick laid on worn out macadam costs \$10,500 a mile 18 feet wide, not including grading or ditching. New water-bound macadam surface costs \$7,400 a mile exclusive of grading and ditching. Maintenance of macadam is \$1,000 to \$1,200 a mile per year, while the cost of upkeep of the concrete road is not more than \$50 a mile. At the end of five years the macadam, repairs included, has cost \$12,400 a mile, and you have nothing for it but a wornout road and growing cost of upkeep. The concrete road, on the other hand, has cost \$10,750, upkeep included, and is still in good condition."

CRUDE RUBBER SHORTAGE

A prominent tire maker, speaking of crude rubber shortage, says in part:

"Over 60 per cent. of the crude rubber used in the United States comes from the Far East, via the Red Sea and the Mediterranean. No merchant ships are passing through these seas now, and we don't know when they will start. Shippers could divert the shipments via the Pacific Ocean to our western coast, but this change would require time and we have no word that such a course is under advisement.

"London has always been the transfer point, but the high grade rubber in stock there would not supply the American rubber manufacturers more than a week. Naturally at this point there are also big accumulations of "off grades" available) that is, cheap rubber usually unsalable for the making of tires), and there has been recent activity in this grade.

"Being shut off from the east, we must look to South America for our supply. Here we find only a few hundred tons in stock, because the Brazilian district has a steady market for all they make during their open season. Just now this country is flooded with torrential rains and the gathering of crude rubber cannot start until October. So we find but little immediate relief there.

"When shipments start to come in from the east, crude rubber prices will probably decline sharply, although it has been reported unofficially that when navigation stopped, the plantation owners laid off their men and ceased tapping the trees."

HORSE-DRAWN VEHICLES MUST HAVE TAGS AND ARE SUBJECT TO SAME TRAFFIC RULES AS MOTOR CARS

New traffic regulations are in force in Washington, D. C. One of the new rules is that no vehicle, except a commercial vehicle, loading or unloading, shall stand for more than 15 minutes at any place on Fourteenth and Fifteenth streets between Pennsylvania avenue and I street, the most congested section in Washington, between the hours of 8 in the morning and 6 at night. Exception is made of government vehicles.

Another regulation is that every horse-drawn vehicle shall have a metal tag so affixed on the right side as to be visible 20 feet. No vehicle horse drawn or motor propelled will be allowed to approach within 15 feet of any car while the same is stopped or stopping for the purpose of taking on or unloading passengers, nor within such distance of the place where a passenger shall have left the street car until the passenger shall have reached a place of safety. Vehicles moving north or south will have right of way over those moving east or west.

The regulations also prohibit the use of a motor muffler cut-out as well as unnecessary or excessive smoke. Electric or acetylene headlights are prohibited on the street unless the rear reflectors are removed or the front glass is either ground or covered with some material of sufficient density to prevent dazzling or blinding to persons using the streets.

The new regulations expressly set forth that pedestrians should avoid interference with traffic and to this end should not step from the sidewalk without first looking to see what is approaching. They are further admonished to cross the street at a right angle, preferably at a regular crossing at the end of a block and, where a traffic policeman is stationed, wait for his signal. Under the old law, which has never been enforced, pedestrians were compelled to cross a street at a regular crossing, but under the new regulations it is optional where they cross, although the regulations ask pedestrians to use the regular crossings instead of crossing at any point. Penalties varying from \$5 to \$40 are provided.

MOTOR CARS FALL UNDER CLASS RATES ON WHICH FULL INCREASE ASKED IS ALLOWED

The Interstate Commerce Commission has made its decision with regard to the application of the railroads for a horizontal 5 per cent. increase in freight rates. In the main an increase of 5 per cent. has been allowed on class rates, under which designation motor cars are shipped; the rates on commodities have not been advanced, nor will there be any increase in the rates on lake and rail shipments. Such increases as have been made will apply only in the Central Freight Association territory, which lies between Buffalo and Chicago. It is in this territory that most of the motor car production centers.

The increase in freight rates will not apply to shipments going to points east of Buffalo but a large percentage of the shipments going south will bear a part of the 5 per cent. increase; the increase will not apply to shipments going to the Pacific Coast, however, due to the existence of a through rate.

Taking the case of a freight rate which is 50 cents per 100 pounds, the net increase amounts to 5 per cent., which on first class merchandise brings the figure to 52½ cents. Motor cars, however, are classed at 110 per cent. of first class rates, which brings the figure to 57¾ cents per 100 pounds.

ANNUAL CONFERENCE OF STAYER MEN

The annual conference of the salesmen of the Stayer Carriage Co. was held in Chicago the week of July 27.

The company enjoyed a very successful business during the past year—the volume of sales being largely increased. The travelers were enthusiastic over the new styles and new features for 1915.

C. B. N. A. CONVENTION

Atlantic City, September 28-October 2

Atlantic City Pictorially Presented to the Appetite of the Man Wanting a Good Place to Have a Good Time, Meet His Business Friends (and Incidentally) Do a Little Turn of Business

The C. B. N. A. convention will, as usual, establish itself in the Marlborough-Blenheim Hotel as the headquarters, and the meeting place as well as the exhibition will be found on Young's Million Dollar Pier. The exhibiting arrangements are much improved over previous times. Space, light, air, protection from sudden storms, are all superior to any previous experience.

Reports are flattering as to attendance. They are also good for as fine an exhibition of accessories as has ever been had.

The strategic position of the place is strong as a puller-in of attendance, because it is so appealing to the southern builder; likewise all other sections find it easy of access. It is a point all seem to like, so attendance is representative. The creature comforts that appeal to man cannot be surpassed, so there you are! There is but one answer. Go to the convention.

As to Atlantic City itself we add a few words for which its Publicity Department is sponsor, and the illustrations are credited to the same source.

Atlantic City is a city of hotels, cottages and shops. Its sole business is to give rest, health and pleasure to the people. On every day of the year, guests are accommodated with the comfort and



Low Tide on the Beach

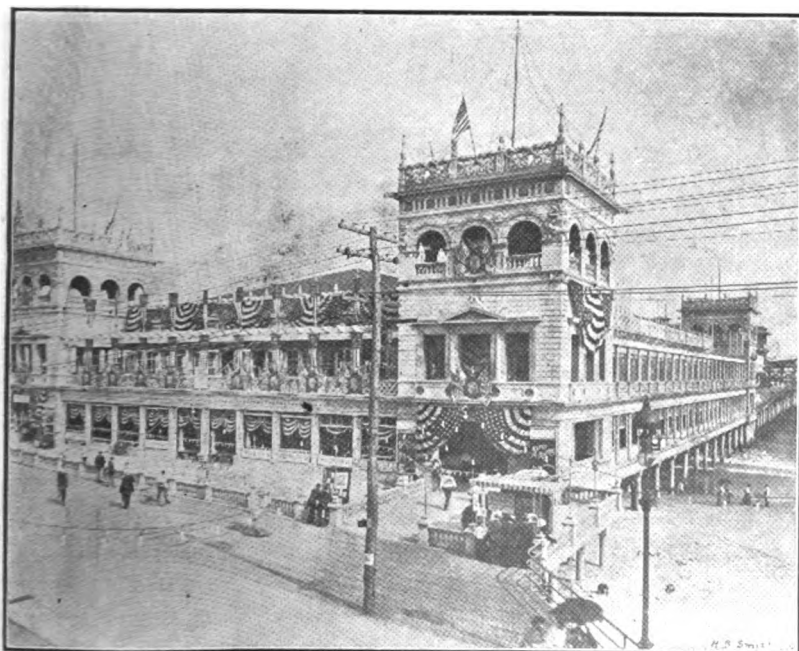

Young's Million Dollar Pier

elegance of the best metropolitan hotels, as well as the most varied facilities for recreation and amusement. The prominent hotels possess every modern convenience and luxury.

The city is one of the most interesting places in America, not only because as an all-the-year-round resort it enjoys a practically never-ending season, but also because it is a city of importance among the municipalities. It is governed by five commissioners. Its public buildings are handsome; its mercantile interests are numerous.

In order still further to enhance the city's attractiveness, a general plan has been made to which its future public works may conform. The plans as outlined include an improved boardwalk and approaches, a civic center, enlarged railroad terminals and the abolition of all grade crossings, additional boulevards and parks, and many other important improvements. Electric light standards, equal or superior to any in use on this side of the Atlantic, have already, in accordance with these plans, been placed on the boardwalk and Atlantic avenue, and the same system of illumination will be gradually extended into other portions of the city. A splendid entrance to the city for automobiles and other vehicles in accordance with these plans has been



MARLBOROUGH BLENHEIM

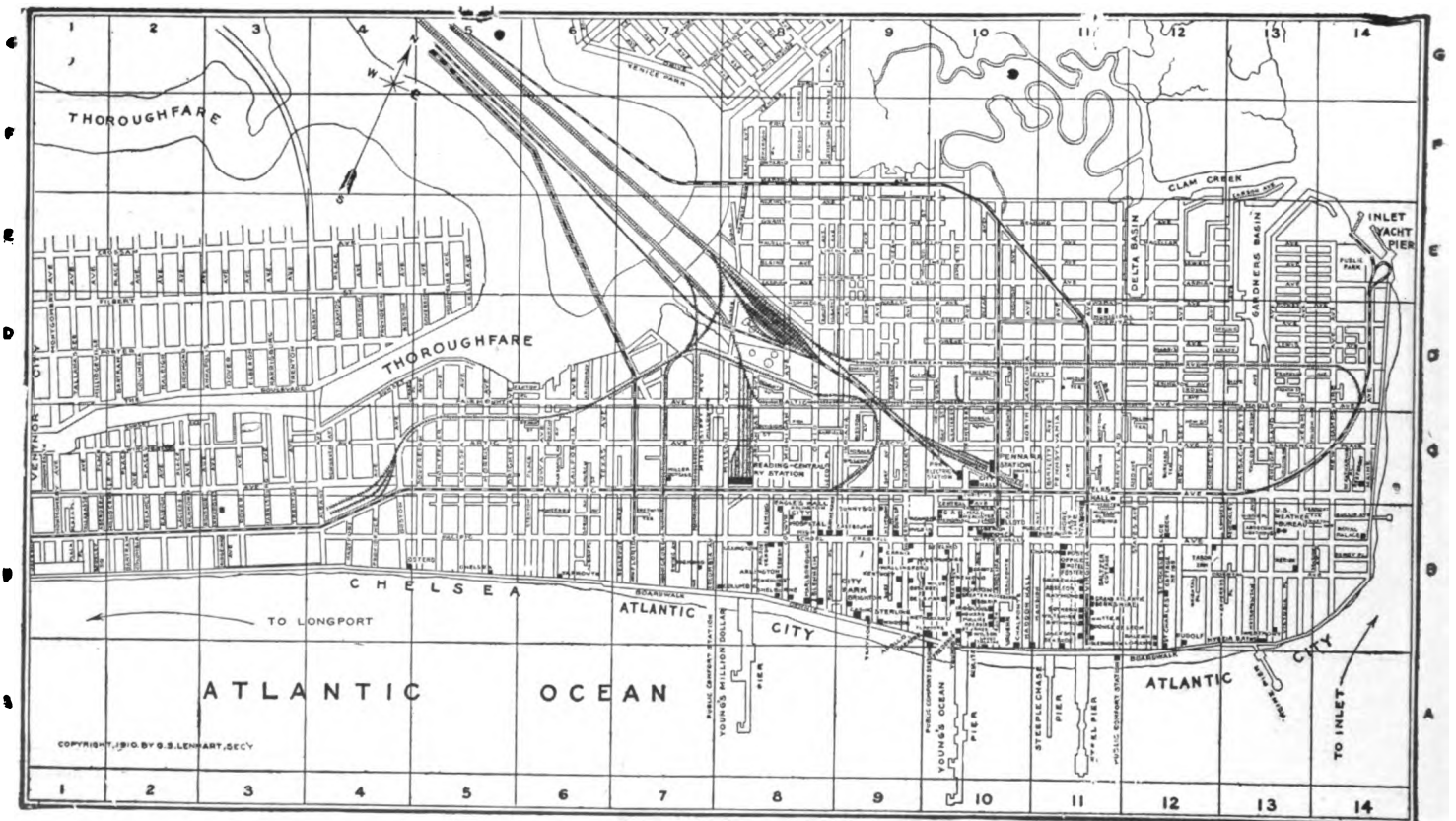

made at Albany avenue. A large tract of land has been purchased for the Inlet Park.

The superior train service to Atlantic City contributes to the comfort, pleasure and safety of the visitor.

A superior trolley service connects Ventnor, Margate, Longport, Absecon, Pleasantville, Somers Point and Ocean City with Atlantic City and affords many interesting excursions for the day. The Ocean City cars cross the bay on a long trestle, affording a unique ride.

The Boardwalk

Visitors find that the most distinctive feature of Atlantic City is the boardwalk. It now extends eight miles along the beach, with a practically unobstructed ocean view. In its central portion it is 60 feet wide, and at no point less than 20 feet. It is a substantial structure, erected from 10 to 15 feet above the strand, upon piling, at a cost of half a million dollars. It is brilliantly lighted every evening in the year.

Along the land side of the boardwalk the shops not only act as a shelter from the occasional north winds, but are one of its charms. There are many excellent stores of a general character in the center of city.

Extending seaward from the boardwalk are six great ocean piers—in all the world the greatest series of piers devoted exclusively to recreation. Concerts by noted bands, theatres, dancing, net hauls, bowling and other amusements, interesting in themselves, have added zest when enjoyed over the ocean. Along the boardwalk are playhouses and other forms of entertainment.

Bathing and Yachting

The bathing beach is the most perfect on the Atlantic coast. Fifty thousand bathers are often seen in the surf at one time in the summer months. For the protection of this multitude is a municipal beach patrol, equipped with boats and other apparatus and under the direction of an experienced surgeon.

Pure Water

The water supply of Atlantic City comes from 21 artesian wells and an auxiliary lake in the midst of an inland sandy forest far from civilization. Numerous tests prove that its high



Cottage Section, Atlantic City

quality never varies. The waters are of unusual purity, very soft and with no indication of pollution.

Good Roads

New Jersey is famous among motorists for its good roads, none of which are more used by them than those which lead from New York and Philadelphia to the splendid boulevard across the meadows to Atlantic City. The garage accommodations in Atlantic City are excellent.

Convention City

Atlantic City is a fine convention city. In addition to being near to New York, Philadelphia, Baltimore and Washington, it has excellent train connections with all parts of the country. It has everything that goes with a large city except great manufacturing establishments and similar commercial interests.

FORTY-SECOND ANNUAL CONVENTION CARRIAGE BUILDERS' NATIONAL ASSOCIATION

Atlantic City, N. J., September 26 to October 2, 1914
Program of the Meetings, Business and Social

PROGRAM FOR FIRST DAY

Tuesday, September 29, at 10 a. m.

It is the desire of the president and the association that the proceedings shall open promptly at the hour named.

And to this session all the ladies visiting the convention are most cordially invited.

The meeting will be called to order by the president, William H. Roninger, St. Louis, Mo.

Address of welcome.

Response on behalf of the association by Homer McDaniel, Cleveland, O.

Opening address by the president, William H. Roninger, St. Louis, Mo.

Address by Adrian D. Joyce, Cleveland, O., on "Modern Business Tendencies."

Address by C. W. Shipley, Cincinnati, O.

Address by E. M. Galbraith, Cincinnati, O.

Nomination of president for the ensuing year.

Appointment of a Committee on Resolutions.

Appointment of a Committee to Recommend Officers for the ensuing year.



Children's Playground

Appointment of a Committee on the Exhibition.
Appointment of an Obituary Committee.
Adjournment.

On this Tuesday evening, September 29, the reception to the members and their families will be held at Marlborough-Blenheim. All members and their families attending the convention are invited to be present. Tickets for this occasion will be furnished free to members and their families.

PROGRAM FOR SECOND DAY

Wednesday, September 30, at 10 a. m.

Meeting will be called to order by the president, William H. Roninger.

Address by H. Collier Smith, Detroit, Mich., on "Sheet Metal Work as Applied to the Horse-drawn Vehicle."

Address by Louis H. Rogge, Dayton, O., on "Vehicle Advertising."

Address by William H. McCurdy, Evansville, Ind.

Address by H. A. White, High Point, N. C.

Report of the Executive Committee, Charles A. Lancaster, South Bend, Ind., chairman.

Report of the Secretary and Treasurer.

Report of the Committee to Recommend Officers for the ensuing year.

Election of president.

Adjournment.

PROGRAM FOR THIRD DAY

Thursday, October 1, at 10 a. m.

Meeting will be called to order by the president, William H. Roninger.

Report of the Committee on Statistics, O. B. Bannister, Muncie, Ind., chairman.

Report of the Committee on Cost Schedules, W. A. Sayers, Cincinnati, O., chairman.

Report of the Trustees of the Technical School, Daniel T. Wilson, New York, chairman.

Report of the Committee on Freight and Classification, Theo. Luth, Cincinnati, O., chairman.

Report of Committee on Abuses in the Carriage and Accessory Trades, Perrin P. Hunter, Cincinnati, O., chairman.

Report of the Committee on New Members, William H.



One View of the Beach

McCurdy, Evansville, Ind., chairman, central division; C. O. Wrenn, Norfolk, Va., chairman, southern division; L. E. Hickok, Mechanicsburg, Pa., chairman, eastern division.

Report of the Committee on the Press, G. A. Tanner, New York, chairman.

Consideration of the report of the Executive Committee.

Unfinished Business.

New Business.

Election of Officers.

Report of the Committee on Resolutions.

Report of the Committee on Exhibition.

Report of the Obituary Committee.

Selection of the place for the next convention.

Adjournment.

ANNUAL BANQUET—Marlborough-Blenheim

Thursday, October 1, at 7 p. m.

Tickets for the banquet can be obtained from the secretary at Atlantic City.

At the annual convention, held in New York, October 9, 1907, a resolution was passed "that the secretary be required to charge for all extra tickets the cost of the same per plate." As this banquet will cost slightly over \$7 per plate, the extra tickets will be \$7 per ticket.

This does not concern the members' own tickets, as they are all entitled to one ticket free. Only applies to the extra tickets any one may wish to have. Please note this so there will be no misunderstanding.

For the accommodation of the members of the association, the secretary will be at the Exhibition Hall on the afternoons of Tuesday, Wednesday and Thursday, September 29, 30 and October 1, from 2 until 5 o'clock, for the reception of new members, giving out banquet tickets, and such other business as may be required of him. The members are earnestly requested to procure their banquet tickets as early as possible, so that we can tell who will be present at the dinner.

To prevent mistakes and misunderstandings, the Executive Committee has adopted the following rule:

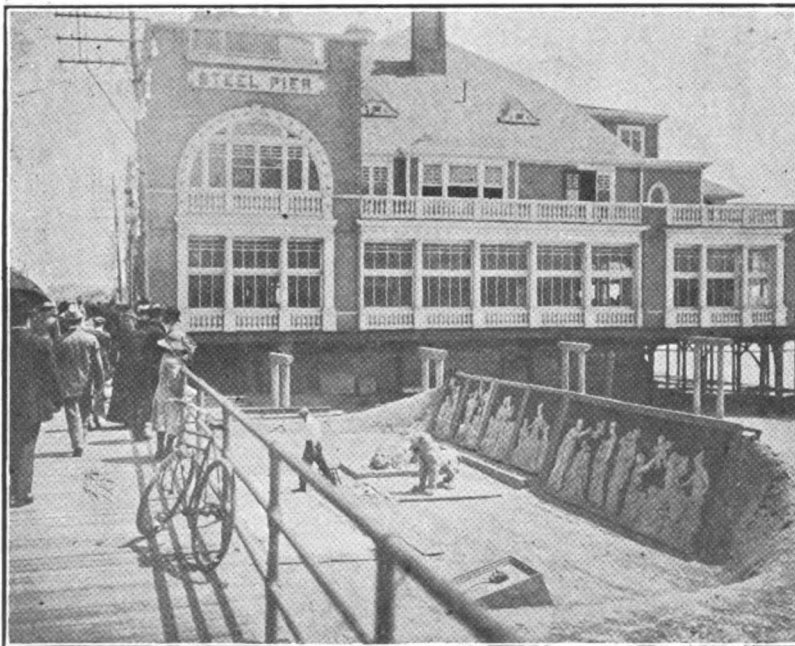

Sand Sculpture on the Beach

Members of the association who desire their representatives to use their banquet tickets must give an order for the same in writing to the secretary.

SPECIAL NOTICES

Business Meetings and Exhibition

Both the business meetings and the exhibition will be held on Young's Million Dollar Pier, Atlantic City.

The Reception

The annual reception will be held on Tuesday evening, September 29, from 8 to 11 o'clock, at the Marlborough-Blenheim.

The Banquet

The annual banquet will be held at the Marlborough-Blenheim, Thursday evening, October 1, at 7 o'clock.

Letters to the Secretary

As the secretary has to be in Atlantic City some days before the convention dates, all letters to him requiring an answer should be mailed so they will reach him at Mount Vernon, N. Y., on or before September 22.

After September 23, the address of the secretary will be the Marlborough-Blenheim, Atlantic City, N. J., until after the convention.

The president and the association most respectfully request all members and visitors, especially the exhibitors and their attendants, to be present at the meetings, to aid in making them successful. There will be many things discussed on Tuesday and Wednesday that will be interesting and profitable to all.

The meetings will be short, not over two hours, from 10 a. m. to noon.

By order of the Executive Committee.

September 1, 1914. HARRY C. McLEAR, Secretary.

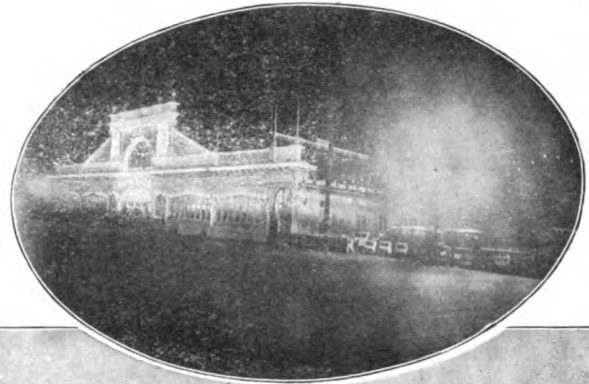

Ocean at Atlantic City



Absecon Lighthouse

EXHIBITORS AT THE C. B. N. A. CONVENTION

Up to the time of going to press the following accessory firms had signed for space at the exhibition to be held on the Million Dollar Pier, Atlantic City, in connection with the forty-second annual convention of the Carriage Builders' National Association. The convention will be held from September 28 to October 2:

- Backstay Machine and Leather Co., Union City, Ind., leather.
- Blacksmith and Wheelwright, New York, trade journal.
- Bradley, C. C. & Son, Syracuse, N. Y., shaft couplings.
- Carr Co., F. S., Boston, Mass., artificial leather.
- Carriage and Wagon Builder, Philadelphia, trade journal.
- Carriage Dealers' Journal, Troy, N. Y., trade journal.
- Carriage Monthly, The, Philadelphia, trade journal.
- Carter Co., Geo. R., Connerville Ind., trimmings.
- Cately & Ettling, Cortland, N. Y., automatic top bows.
- Chase & Co., L. C., Boston, Mass., artificial leather.
- Cleveland Hardware Co., Cleveland, O., forgings and hardware.
- Conneaut Leather Co., Conneaut, O., leather and bows.
- Cortland Forging Co., Cortland, N. Y., vehicle forgings.
- Cowles & Co., C., New Haven, Conn., mountings and lambs.
- Crandal, Stone & Co., Binghamton, N. Y., vehicle hardware.
- Ditzler Color Co., Detroit, Mich., paints.
- Du Pont Fabrikoid Works, Wilmington, Del., artificial leather.
- Eberhard Mfg. Co., Cleveland, O., vehicle hardware.
- Fairfield Rubber Co., Fairfield, Conn., artificial leather.

Ferrel Brake and Mfg. Co., Cleveland, O., brakes.
 Fernald Mfg. Co., North East, Pa., shaft couplings.
 Firestone Tire and Rubber Co., The, Akron, O., tires.
 Gerhab, Jacob, Philadelphia, vehicle hardware.
 Goodyear Tire and Rubber Co., The, Akron, O., tires.
 Herbrand Co., The, Fremont, O., vehicle forgings.
 Hub, The, New York, trade journal.
 Illinois Iron and Bolt Co., Carpentersville, Ill., axles.
 Kelly-Springfield Tire Co., New York, tires.
 Keystone Forging Co., Northumberland, Pa., vehicle forgings.
 Liggett Spring and Axle Co., Pittsburgh, Pa., axles and springs.
 Metal Stamping Co., Long Island City, N. Y., forgings.
 Monarch Carriage Goods Co., Cincinnati, O., carriage hardware.
 National Carbon Co., Cleveland, O.
 National Malleable Castings Co., Cleveland, O., vehicle castings.
 Peters & Herron Dash Co., Columbus, O., dashes.
 Raser Tanning Co., Ashtabula, O., leather.
 Rhodes & Co., Jas. H., Chicago and New York, sponges, etc.
 Rielly & Son, P., Newark, N. J., leather.
 Rodriguez, R. E., New York, brushes.
 Rogers, E. F. & Co., Philadelphia, carriage materials.
 Rose Mfg. Co., Philadelphia, lamps.
 Scranton Axle and Spring Co., Scranton, Pa., springs and axles.
 Sheldon Axle Co., Wilkes-Barre, Pa., axles and springs.
 Sherwin-Williams Co., Cleveland, O., paints and varnish.
 Simplex Short Turn Gear Co., The, Anderson, Ind.
 Smith & Co., Edward, New York, varnish.
 Spokesman, The, Cincinnati, O., trade journal.
 Standard Steel Spring Co., Coraopolis, Pa.
 Standard Varnish Works, Chicago, varnish.
 Standard Wheel Co., Terre Haute, Ind., wheels.
 Straus & Sons, M., Newark, N. J., leather.
 Valentine & Co., New York, varnish.
 Wade Manufacturing Co., Brockton, Mass., imitation leather.
 Ware Bros. Company, Philadelphia, trade journal.
 Western Spring and Axle Co., Cincinnati, O., springs and axles.
 Wilcox Mfg. Co., Mechanicsburg, Pa., gears and vehicle hdwe.
 Willey Co., C. A., Hunter's Point, N. Y., paints and varnishes.
 Woll & Sons Mfg. Co., Peter, Philadelphia, hair.

COME ONE AND ALL

The Carriage Builders' National Association extends to the carriage, wagon and sleigh builders of the United States and Canada a cordial invitation to attend the forty-second annual convention of the association at Atlantic City, N. J., on September 29, 30, and October 1 of this year.

A visit to the convention and the exhibition of the materials used in the construction of your productions and in your business, and a few days spent by the sea in that delightful city cannot help being of benefit in every way.

The association will be happy to see you, and you will be welcome whether a member or not. The convention and exhibition are free to every vehicle builder, as our sole purpose is to benefit all builders of vehicles.

By direction of the association. HENRY C. McLEAR,

Secretary.

C. H. A. T. WILL CONVENE IN ATLANTIC CITY SAME DATE AS C. B. N. A.

The twenty-fourth annual convention of the association will be held September 28 to October 2, at Atlantic City, N. J. As this is the week of the Carriage Builders' National Association convention there is an excellent opportunity to attend both, thus combining business and pleasure. The annual meeting will be held at Marlborough-Blenheim Hotel, Tuesday evening, September 29, at eight o'clock. Wednesday night, September 30, will be known as C. H. A. T. night, when the shore dinner will be served at the Marlborough-Blenheim.

Following are association officers: President, E. B. Williams,

New York City; vice-presidents. F. J. Johnson, Los Angeles, Cal.; J. H. Wilber, Cripple Creek, Col.; B. S. Amos, Baltimore, Md.; W. H. Digges, Fort Worth, Tex.; Chas. A. Quigley, Salt Lake City, Utah; Max Robinson, Martinsburg, W. Va.; M. S. Bottume, New Haven, Conn.; H. F. Kircher, Peoria, Ill.; George A. Small, Woodford, Me.; J. F. Hutcheson, Covington, Ky.; F. S. Collins, Amesbury, Mass.; Oscar Becker, Jackson, Miss.; N. D. Allen, Kansas City, Mo.; Mark Reeks, Newburgh, N. Y.; W. P. Lippincott, Merchantville, N. J.; G. O. Ballantine, Cleveland, O.; R. A. Bittong, Philadelphia, Pa.; Charles G. Ranno, Manchester, N. H.; J. M. Palmer, Brooklyn, N. Y.; secretary and treasurer, Jesse L. Nelson, 1172 Bedford avenue, Brooklyn, N. Y.; board of directors, E. A. McGrew, chairman, New York City; W. W. Wood, Philadelphia, Pa.; F. D. Reed, Boston, Mass.; Grant Wright, Philadelphia, Pa.; P. D. Randall, Springfield, Mass.; F. H. Gowen, Little Falls, N. Y.; H. E. Copeland, West Newton, Mass.; Geo. W. Huston, Cincinnati, O.; John F. Galvin, New York City; W. J. Sohlinger, Dayton, O.; James R. Swan, Indianapolis, Ind.

THE TIGER OR THE HERCULES?

This is a paraphrase of "the tiger or the lady." It tells about a significant move. It is from the Freeport Bulletin:

The Moline Plow Co. branch, known as the Freeport Carriage Co., will cease to exist after August 1, and the Tiger Vehicle Co., of Freeport, will take its place. Thereby hangs quite an interesting story.

The factory will close down until August 1 to take inventory and make necessary repairs and a number of changes.

The Tiger Vehicle Co. will still be a branch of the Moline Plow Co., but instead of being under the direct management of the Moline Plow Co., as has been the case in the past, the reorganized concern will have an entire new set of officers representing the factory in Freeport, also between 30 and 40 salesmen on the road, with the Freeport factory as headquarters.

The change is being made on account of the mail order houses going into the vehicle business so extensively. Last year the cash was sent into the catalog houses for 60,000 vehicles, and the mail order business has grown to such an extent in the last few years that to compete with the factories that make vehicles for the catalog houses, it is necessary for the vehicle factories to get busy and reach out to get the trade of the retail dealer and put the vehicles to him at a price which he can retail them at, and compete with the mail order business.

In the past, the Moline Plow Co. has confined its business to the large jobbers and the large retailer who could purchase vehicles in quantities. This method of doing business will be changed, and the Tiger Vehicle Co. will sell its product direct to the retail dealer in quantities to suit his convenience.

The catalog business which the Freeport Carriage Co. conducts will be handed to the Henney plant, this amounting to between 15,000 and 20,000 jobs each season.

TAKES IN MANY

Parry Mfg. Co. has arranged to exhibit at Iowa, Minnesota, Indiana, Wisconsin and Texas state fairs this season.



EXPLANATION AND ANNOUNCEMENT

The article that was to have begun in this issue of *The Hub*, from the pen and experience of A. Gottlieb Bela, the leading, and only original exponent of working metal by machinery for vehicle bodies, will appear in the October issue, and continue monthly. The pressure on space this month due to our exploitation of the storm buggy necessarily crowded out this other important feature.

OFFICIAL ANNOUNCEMENT 1914-15 TECHNICAL SCHOOL FOR CARRIAGE DRAFTSMEN— ESTABLISHED 1880

The classes in carriage, wagon and automobile drafting and construction, carried on under the auspices of the Carriage Builders' National Association and the Automobile Chamber of Commerce, will open in the last week of September, under the direction of Prof. Johnson, as usual. Autumn term closes at Christmas. Winter term opens in the first week of January and closes in the second week of April.

Requirements for Admission to the Day or Evening Classes

1. The applicant must be engaged in the manufacture of pleasure or business vehicles.
2. He must be 16 years of age or more.
3. Be able to speak, read and write English, and to write a fairly good business letter.

Day Class

This class is to accommodate pupils who wish to devote their whole time to the study of vehicle drafting. This class will meet each week day except Saturday during the term. Hours: 9:30 a. m. to 4:30 p. m. Instruction is free.

Evening Classes

Monday, Wednesday and Thursday from 7:30 to 9:30 o'clock. Instruction is free.

All communications relating to the Technical School for Carriage Draftsmen and Mechanics should be addressed to Andrew F. Johnson, 20 West Forty-fourth street, New York City.

Courses of Instruction

The pupils will be divided into three distinct classes, namely: The introductory or free-hand class, the class for the study of descriptive geometry, and the class for scale and full-size working drawings, and the following gives a general outline of the proposed studies: I. Linear designing, including free-hand, scale, and full-size drawings. II. Geometry applied to carriage, wagon and automobile construction and known as the "French rule" of drafting. III. Complete carriage and wagon drafting and automobile body drafting. IV. Principles involved in the suspension and draft of carriages and wagons. V. Perspective and colored drawings of carriages, wagons and automobiles.

Drawing Instruments

Drawing instruments, drawing boards, and other things necessary for the work, may be had at the school at very low prices.

Certificates

At the close of the term Certificates of Graduation will be given to such pupils of the day and evening classes as pass the necessary examinations.

The following conditions govern the graduation of pupils: No pupil will be entitled to a certificate of graduation unless he can pass, in the judgment of the trustees, a satisfactory examination in all the branches taught. He must, upon examination, evince a thorough knowledge of geometry as applied to carriage building, known as the "French rule of drafting"; show facility in making free-hand drawings, be able to make scale and full-size working drawings of carriages and wagons com-

plete and automobile bodies. A knowledge of perspective and colored drawings is also required.

He must also have a knowledge of arithmetic through square root, to work out the problems connected with draft and suspension, and thus determine the proper sizes of wheels, axles and springs, and he must be able to write clearly and correctly the orders for the same to the manufacturers of these special parts.

Graduates are in demand, and are holding good positions in the leading automobile and carriage factories.

Correspondence Department, Managed on the Chautauqua System—Instructor, Mr. Andrew F. Johnson

Correspondence School is open the whole year round.

Instruction in this department costs \$5 per term or \$15 for the full course of three terms.

Instruction is given by correspondence to the employes of carriage, wagon and automobile builders and members of the accessory trades, at their homes, by means of the so-called "Chautauqua system."

This system consists in giving instruction to out-of-town pupils through the mail, by lesson paper, on making free-hand, geometrical, scale and working drawings, each paper calling for responses in the form of drawings or written replies, which are afterwards examined and corrected by the instructor, Mr. Andrew F. Johnson.

Three terms are required in order to complete the full course of corresponding lessons, which are 98 in number, as follows:

First Term

First Series—Free-hand drawing. Eleven lessons.

Second Series—The use of arithmetical instruments and curves, and mode of sketching a carriage. Ten lessons.

Third Series—Geometry applied to carriage construction; projection of points, lines and surfaces, laying out working draft of a phaeton body, and generation of surfaces illustrated on a phaeton. Eight lessons.

Second Term

Fourth Series—Movements of triangles and lines in space; rules applicable to plane faces illustrated on a trestle, a phaeton pillar, a cabriolet pillar and bottomside of a landau, showing the method of finding the true size and shape of a pattern, and the bevel of shoulders of the cross bars. Thirteen lessons.

Fifth Series—On finding the dihedral angle, or in work-shop parlance, finding the bevel of the leg of a trestle, phaeton pillar, cabriolet pillar, and landau bottomsides. Six lessons.

Sixth Series—On the choice and disposition of joints. Three lessons.

Seventh Series—On the development of the outside surfaces of carriage and automobile bodies, including round corners with wheel-house. Nine lessons.

Third Term

Eighth Series—Laying out square and round-cornered stick seats, and round-paneled seats; generation of double-curved surfaces, illustrated by a barouche with round bottomsides, including the study of different forms of bodies, such as drop-center landaus, and broughams with ogee turn-under; ogee front-quarter, bottomsides of coaches and barouches; cheat line and proportional triangle illustrated on a Clarence body and on a C-pillar hack-quarter. Twenty-four lessons.

Extra Series—The draft of vehicles and division of weight, displacement of center of gravity, and objectionable modes of suspension. Four lessons.

Miscellaneous Series—New methods of determining the cheat line; locating the joints in top braces; developing outside surfaces having different side sweeps and turn-unders; developing mud guard surfaces by means of radial lines and by triangulation. Ten lessons.

On the receipt of tuition fee, all lesson papers for the term will be mailed to the pupil at once, in order that he can see to what the lessons are tending, and any pupil who has finished the study of the full term lessons, will, by sending tuition fee

for the next term to the instructor, receive the whole number of lessons for that term.

Written examinations will be required at the end of each series of lessons, in order to test the progress and proficiency of pupils, and at the close of the course diplomas will be awarded to those deserving such recognition.

All employes of manufacturers of carriages, wagons and automobiles, and the trade accessory thereto, doing business within the United States and Canada, are eligible to membership in these classes of "Corresponding Pupils," the only conditions of entrance being the remittance in advance, by postoffice money order, of \$5, which will cover all fees of instruction during one term.

Each pupil will be expected to provide himself with necessary drawing instruments, papers, etc., and to pay postage on all communications sent to the teacher.

Works of reference and text books will be recommended to pupils who show the need of such help; and, if desired, these, as well as drawing instruments, papers, etc., will be supplied at cost price by the teacher.

This department is kept open during the entire year, and pupils may join at any time.

Special

Day students in this school may enter the evening classes conducted in the Mechanics' Institute and take up subjects not taught in the Technical School for Carriage Draftsmen and Mechanics, such as machine drawing, mathematics, physics, decorative design, modeling, etc.

Instruction is free.

Board of Trustees of the Technical School: Charles J. Richter, chairman, Hon. Franklin Murphy, W. W. Ogden, D. T. Wilson, Wm. R. Innis, secretary. Honorary trustees: Charles Clifton, Herbert E. Rice.

KELLY TIRE PAYING BACK DIVIDENDS

All conditions precedent to the payment of the 78½ per cent. cumulative dividends upon the present outstanding issue of the 6 per cent. cumulative preferred stock of the Kelly-Springfield Tire Co. have been complied with, and the directors have ordered that the cumulative dividends be paid. June 15 was fixed as the date of payment of these cumulative dividends in second preferred stock to preferred stockholders of record May 6.

Over 90 per cent. of the 50-year four per cent. income debenture bonds have been deposited with the Bankers Trust Co., New York City, under the terms of deposit agreement of April 15. Directors of the tire company have adopted resolutions authorizing the Bankers Trust Co. as depository under the deposit agreement to exchange 50-year debenture bonds for 6 per cent. cumulative preferred stock on a basis of one share of preferred stock of a par value of \$100 for each \$100 face value of bonds.

AIR-COOLED GERMAN PRACTICE

In Germany parcel cars of various sorts are growing in favor. Three-wheelers are much in favor in Berlin and other German cities.

As typical of another class of construction, we have an air-cooled light car chassis which is from Markranstadter Automobil Fabrik.

After much experience of this type in hard service, this small machine practically never shows signs of overheating, although its air-cooled engine, together with its fan accessories, is totally enclosed in a bonnet. The exhaust valves never show any signs of unduly hot working conditions.

It is principally in respect of the engine that interest centers. The cylinders are of the twin-block type, and the exhaust valves are unusually large in diameter, the latter being set in the tops of the cylinders and operated by overhead rocker valves, the push rods for which are entirely enclosed in grease baths.

The inlet valves are on the same side of the cylinders as the exhausts, and are operated from the common cam shaft. The top of each valve pocket carries the sparking plug. The cooling itself, which is apparently so very efficient, is effected by two powerful fans, one mounted on each side of the engine, and each of these is driven by a flat belt kept taut by an adjustable jockey-pulley.

WHAT DO YOU KNOW ABOUT A WHIPPER?

Here is an illustration that will appeal to drivers who hate to get wet in a shower.

The picture is of a "storm" buggy, and the whipper is shown so its workings may be understood. It's a neat idea, well

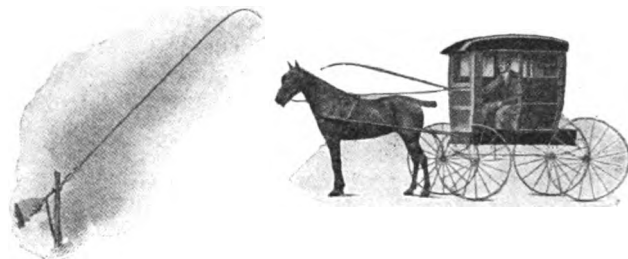

worked out and would sell in about all stores that sell whips, and where is any harness dealer who does business without a stock of whips?

C. R. Patterson & Sons, of Greenfield, O., who make the "whipper," describe its points this way:

This whipper has been tested for twelve months, giving perfect satisfaction; it is a ball and socket arrangement; it permits no air holes for draughts nor leaks; it is automatic and returns always into position ready for use; it is noiseless, no rattle whatever; it can't get out of fix; you can whip a horse as hard as you desire; the whip is retained with set screws and therefore it can not be lost, and is not easily stolen; you can whip a team as easily as one horse, you can whip in any direction; it is cheap in price; it is simple and easily attached; it fits any thickness of panel, ½, ¾ or 7⁄8 in.; it is patented in every feature, but the plan of its distribution is to supply them at cheapest possible price over the cost of manufacture.

A DISAPPEARING TOP

Each year there is added to the considered almost perfect pleasure motor car, some new features of practicability. So it is with one most striking feature embodied in the new type of Stevens-Duryea roadster now being marketed. This company is the first to put into operation a serviceable, durable and attractive top combined with a handsome type of body, which will allow concealment of the top when lowered. The top is supported by rigid joints which cause it always to follow a certain path in folding into and being withdrawn from the body. It is self supporting and when up requires no braces of any kind, being fastened in front to the windshield supports in the same manner as in the Stevens-Duryea touring cars. When the top is folded the concealing compartment is covered by the upholstery. The opening is also covered by the upholstery when the top is in use.

TIRE PRICES

The tire and rubber situation is acute. The principal tire companies have advanced prices from 12½ to 20 per cent.

Practically all have reached the higher level, but none have advanced beyond the first increases.

The crude rubber situation, according to rubber importers, is unchanged. The high price of \$1.10 for plantation and \$1.12 for Para still holds without an advance.

Paint Shop

HOW TO AVOID HOT WEATHER VARNISH ROOM DEVILTRIES

Now, and from this time on, varnish room difficulties, due to weather changes and humidity are, and will be, painfully in evidence in many shops. In some of these shops it is an impossibility that any varnish, at any season, could do its best, but in some of the sweltering days we must encounter, the varnisher must be prepared for strenuous combat with the evil spirits.

Eternal vigilance is the price of good varnishing under even the most favorable circumstances, and if some of the fraternity, who by circumstances and environment are heavily handicapped, will heed what follows they may be spared a good deal of worry and perhaps unprofitable work. Now, no matter what size or where situated the varnish room is, there must be found a way to ventilate it. Fresh air, and plenty of it, is a vital necessity to good varnish, and we have confidence enough in the craft to believe that any man who can do a good job of varnishing, has ingenuity enough to devise some means of ventilation for even the poorest located varnish room, and to do it in such a way as not to create a current of air that will keep every particle of dust in the room in motion. No matter what kind of strenuous efforts you have made to get rid of dust, don't ever take it for granted that there is none present. Like the poor, dust will always be with us.

The time to get rid of it is when the varnish room is empty, and it should be empty just as soon as the last job varnished is hard enough to be moved out, then blessed is the man who has a good, big platform out doors where the job can sit in real, fresh air, but never in sunshine, and it will do its best and harden clear through in a way it could never have done in foul air.

Don't fail to have the varnish room made thoroughly clean at every opportunity, and as nearly as possible kept so. Let nothing be in the room that can harbor dust. A hair broom is about the only thing that can be relied on to clean overhead and the side walls. Glass in the windows should be kept clean. One cannot well have too much light when working with varnish. Around the window sash and casings dust loves to linger. Get it out if you have to turn a hose on it. Do not, if by any means you can avoid it, rub varnish in the varnish room. If you must do so, use a mop to clean up the floor, and just here make a note of it that the varnish room floor that is not mopped occasionally is not clean, and if you are one of the unfortunates whose body truck is a barrel, and you have to keep turning it around as you work, only mopping the floor can do anything to help you in getting free from floor dust. Cleanliness is about the biggest thing in good varnishing always, but in such weather as we may now expect, when neither paint nor varnish will dry reliably in schedule time, and yet cannot be given an extension, one must be exceedingly careful. The chamois and sponge, and pail and water cannot be too clean and free from every suspicion of grease.

The effect of a half clean chamois on a rubbed surface at all inclined to be sweaty cannot be but disastrous to some parts of it. Keep a sponge, chamois and pail, for varnish room use only. Never, never wipe the hands with a chamois as though it were a towel, and see to it that no one else does. If anywhere prevention is better than cure, it is surely in the varnish room. Fresh air and cleanliness are mighty factors for good work there, but there are some other things we must see to, to make them effective. From bare wood up, first know that each

coat is thoroughly dry before another is applied. Don't take it for granted that because it has been on so many hours it must be dry, better to lose a day's time in the doing of a job and have it come out right, than to risk having to do it all over again for nothing. In this weather don't aim too much at elasticity.

I don't believe that as a binder for superfine color there is anything as good as pure, raw linseed oil. At the same time in such weather, oil is a dangerous thing in the hands of a careless man, or in any hands when time to thoroughly dry cannot be given. No superfine color should be applied directly on rubbed out rough-stuff without a binder of some sort, especially if a second coat of superfine color is to be used.

These two coats of color could be applied, the first one in the morning, carrying not more than six or eight drops of oil to as much color as will do a piano box buggy body. The second coat might follow at about 3 p. m. without adding any binder, and at 5 p. m. would be fit for color varnish. Personally, I would prefer one good coat of color well beat up, then turps added to make it of brushing consistency, then not more than one-eighth as much oil as turps added and given at least one hour to assimilate, then applied and given all night to dry.

I have never known this to cause trouble in any weather, neither should it, provided the rough-stuff has thoroughly dried out before applying it. Using a good color varnish, there is not, in the case of black especially, any reason for two flat color coats. The cause of many an otherwise nice job going wrong at the last is the practice of rubbing the varnish on one day and varnishing on the next, without re-rubbing. One might once in a while get away with it in the nice cool weather, when things dry and harden as they ought to, but in the good old summer time always do your varnishing the same day you rub the job if you would be safe. Just one thing more; for months to come, on nearly every grade of work, especially on all re-painted jobs that are not liable to get high grade care, a harder and quicker drying varnish will give better results than the extremely elastic high grade varnish will, and can be put into use sooner and without the fear of mud spotting and other calamities due to the innocence and ignorance of the man that cares for them.

REPAINTING PROCESSES

The painter meets with a difficult problem generally when the automobile with the metal body comes in for repainting, or touching up and revarnishing, because the metal body—and we are now speaking specifically of aluminum—during the process of its first painting has been faced down, not infrequently, so close that but comparatively little color, or other material, is left upon some parts of the surface. This is due to the fact that some builders apparently fail to observe the filling up practices in vogue upon surfaces of wood, and as a result there is an insufficiency of foundation coats over which to do the facing down. The hard knocks of service do the rest, so that when the painter is called upon to handle the job there may be both patches of bare metal and patches of thin, fragile pigment, to be treated so that at least a fairly durable piece of surfacing may be established.

Practically the same results are experienced in connection with sheet steel panels, in which case the exposed spots of metal are more than likely to rust before getting to the paint shop. The aluminum, while not rusting, does, however, show the effects of a disease known to metal workers as "dry rot," markedly

when for any considerable time exposed to dampness. All such spots should be thoroughly gone over with emery cloth until the rust is well cleaned off, and then they should be touched up either with a bit of red lead or of graphite paint, or with lampblack and keg white lead mixed with one part raw linseed oil to three parts turpentine.

In case of the thin, pigment films which by virtue of a scaly condition or of a shattered, fractured face may be recognized upon a close examination, hard sandpapering should be resorted to and then touching up with the lead and lampblack mixing.

Metal bodies show bad effects of service around the mouldings where the paint and varnish has fractured and scaled, and all such places should, of course, be scraped and sandpapered thoroughly and given a strong touching up with some one of the pigments above mentioned.

When automobile bodies come to the shop with these conditions present, touching up and varnishing is quite out of the question. The spots having been touched up properly, the general condition of the surface should lead the painter to judge accurately whether a coat of lead should be applied over all, with some necessary surfacing upon it, or whether the color applied directly upon the old foundation will suffice. Of course, if the price to be received for the work will admit, it were better always to apply the surfacing coat of pigment.

In the repainting of the sheet steel and aluminum bodies from the metal up, after removing the old paint structure, we believe a thorough coating up with the regulation surfacing pigment, including roughstuff, should be done. There is nothing so directly contributing to the durability of the paint and varnish structure as a primary and filling up foundation, possessed of well balanced strength and stout proportions.

Another point not to be overlooked in repainting is in the wings and bonnet and such parts of the under gearing as show prominently. Good protection and an excellent finish should be provided for such parts. They are conspicuous, and unless well finished give the job, as a whole, an ill-balanced effect. In cleaning up the chassis, especially if coming direct from the machinist or engineer, and therefore more or less saturated with oil and grease, paraffin has recently been found exceedingly effective as a preliminary cleansing medium, to be followed by a saturation and wiping up with turpentine. While somewhat more expensive than other fluids, turpentine is safer and possesses the property of assimilating and removing greasy substances with greater rapidity and completeness than other known mediums.

All pipes and under parts which are not, or scarcely at all, discernible save when specially looked for, may be adequately finished, after a thorough cleansing, by applying a single coat of jet black and one coat of black japan.—Cooper's Journal.

LOOK TO YOUR SIDE LINES AS WELL AS YOUR FRONT LINES

No matter where a mechanic may be located, how constant his employment and certain his pay day, he cannot afford to neglect the cultivation of any talent he may possess for other work of some kind, no matter how different it may be from his trade.

There is nearly always something that every man could do, as well as, if not better, than his regular work, which simply means that for some peculiar line of work he has a natural aptitude. Fortunate is the man whose business in life is to work at the thing he is naturally adapted to, and can put his whole soul into his work without wishing it was something else. As regards professions and trades to which men have been trained, probably 3 per cent. would total all that are in the niche they were ordained to fill.

Reference is not being made to what we familiarly term square pegs in a round hole, nor to misfits of any kind. Millions of men have mastered arts and trades, who really never should have had any connection with them, and their mastery

of them has been attained through hard study and hard work conscientiously done, done too in uncountable cases with a full knowledge of the fact that there was other work—congenial work—they would delight to do, but circumstances put it beyond their reach. We all know such people. They are mostly nearing middle age, or elderly. They never had your chance, young man. There isn't today a profitable profession or business, all the way from law to plumbing, that a young man cannot now get posted on sufficiently to give him a start, if he has the grit to work, and he can in time get into the business he is best adapted to, but, go it while you're young; it's hard uphill work to change your business after you have got into a settled way.

This is being penned with a view to being helpful to those who have got into the settled way, and must by force of circumstances continue in it, yet need some addition to their earnings to enable them to live as they ought to and bring up a family respectably. The carriage painter, located in the country shop to whom the suggesting of some profitable side line of work that can be carried on in connection with his regular business, is the individual in mind. Throughout the whole country there are carriage painters making use of all sorts of side lines. They have to. Work at their trade is an uncertain quantity. They know as well as did the philosopher who uttered it, that "all things come to him who waits," but, wiser than he, they also know that the only way to make them come in time to be of any use in this world, is to hustle while you wait. Therefore, they use side lines. Wonder who coined the expression. We all seem to know intuitively that what is meant by a side line is some business or occupation one carries on in addition to his regular business, or as we may say, his "specialty."

Here's a query, can any man really be said to make a specialty of anything, if he engages in any other business quite distinct from it? Lots of room for discussion there, but little profit in it. There's a whole army of people who make a specialty of discussion, and to whom their regular business is but as a side line, and we can't possibly risk inviting profitless discussion. If you know of any profitable business that can be carried on in connection with the trade of carriage painting, no matter what it is, we shall be glad to have you tell us of it. Our sole aim in the matter is to be helpful to any who need help in that way. You need not write for publication unless you want to, but if you do, and the matter you send is available to publication you will be paid for it, at any rate if you will let us know of any such, it will be appreciated.

Queer things are used as side lines by some of the fraternity, for instance, tuning pianos, rag carpet and rug weaving, shoe making. Now, these are things totally dissimilar from the trade. The weaving and shoemaking we can easily understand could be carried on in the shop or some outbuilding connected. Piano tuning would be mostly done at peoples' homes, hence in a measure objectionable, yet good money should be made at it, if in a locality where pianos were plentiful, and it seems to us piano tuning might become the real business, and painting the side line, yet, the man on the ground is the best qualified to say. Among the things we would judge most suitable for side lines would be sign writing, ticket and show card writing, house painting and paper hanging, bicycle repairing and painting, carriage trimming and furniture repairs. There is not the demand now for bicycle repairs or painting there once was; almost everyone who owns a bicycle can paint it with ready mixed dope good enough to suit himself, and the matter with ordinary carriage and wagon painting is that a majority of people outside the big cities hold similar opinions.

There is always a lot of carriage trimming in every town that ought to be done, and no doubt some of it would be, if people were properly approached and kept continually reminded of it, and it is not so difficult to do as it mostly appears on the surface. The repair, painting, varnishing and even upholstering of furniture is simple and goes good, and there is nearly

always some to be done. The simplest of tools only are necessary, and are mostly to be found in every shop, the one really particular thing is, that the work be well done and neatly.

Women folks are particular, and consider every cent they spend, but to get just what they want are really more generous paymasters than men. The thing most important and absolutely indispensable is advertising in some form or other. Occupy a small space in your local paper. Get some neat cards printed and see that they get into every house; tell your little story plainly and in the fewest words possible. Don't forget that once telling is not enough. Keep at it. You won't have been long enough at it until whatever your line is, and whatever your name is, people can't hear or read about either without thinking of you. Don't look at advertising as an expense; it's an investment and if judiciously done and persisted in, returns its cost many times over so that really nobody may be said to pay for it. It has created all business, and being persisted in sustains all. Don't expect people to remember you just because you once had dealings with them. Force them to remember by keeping your name and business where they must necessarily see it.

Hardly a man, woman or child who reads, but thinks soap, when they see the word "Pears," but it has taken over a hundred years to get there, and there isn't a doubt but that if they quit advertising for twelve months, the next most persistent advertiser would own the business. All the trade left them would be from those who had once "got the habit." It would be the old story, "a King arose who knew not Joseph." Do not let people forget you.

STRAINED AND UNSTRAINED PAINT

The straining of paint is sometimes considered a needless task. The idea seems to exist that paints being so finely ground nowadays, straining is only necessary when fine work has to be done. Such, however, is a mistake, for a strained paint will not only be finer, it will also be more protective, and easier to work than an unstrained one. The fact is, straining a paint really mixes it better than it otherwise would be mixed—it is a sort of double mixing, with the result that the pigment and media are amalgamated closely, and thus rendered more durable. As far as the extra ten minutes taken to strain a potful of paint is concerned, we are sure it is more than atoned for by the fact, not only of the paint's increased durability, but by the speed at which it may be applied. This last fact is too often lost sight of, too. The strained paint being better mixed, and consequently smoother, slips along without any little bits of skin and odd unmixed particles eking from the brush, and hindering progress, as almost invariably happens with the other paint. When both paints are considered, then, there cannot be much question that the strained material is in reality the time saver, so that this fact, combined with its superior protective property, should surely convince in regard to the virtue of straining even for the most ordinary jobs.

TIMBER SAWYER

Example of Italian Renaissance Lettering

RACK TO HOLD AUTOMOBILE-ENGINE HOOD WHILE PAINTING

When repainting or revarnishing an automobile it is very difficult to have the hood stand upright without falling over and spoiling the paint. To have it fall would mean doing the

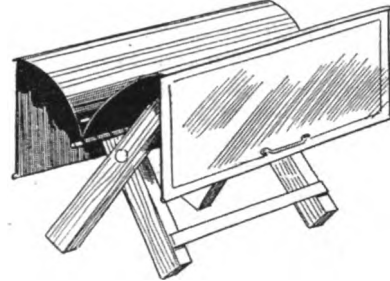

Shape of the Sawhorse Holds the Hood in the Right Position for Painting

work over. A simple way to overcome this trouble is to secure a wood sawhorse and lay the hood on it, as shown in the illustration.

LEAD COATS

The lead coats in their consecutive order of first, second, third, and, if necessary, fourth, lead coats, have always created more or less confusion in the minds of the paint shop beginners, but they need not, and, in fact, will not, if the clear distinctions between the various mixtures are properly maintained.

The first lead is, technically speaking, the primer, and may be composed of various ingredients, the chief and indispensable one being raw linseed oil. Whatever pigment ingredients may be employed—white lead, ochre, etc.—are merely for the purpose of checking the excessive penetration of the oil.

The second lead is composed of more pigment and a decidedly diminished quantity of oil. In fact, the oil no longer plays the chief part. This lead, generally speaking, to meet modern conditions, should be composed of white keg lead, as the basic pigment, and whatever other supplementary pigment, or pigments, local conditions may invite. The percentage of oil should be 25 per cent., with the remaining 75 per cent. covered by turpentine. A few drops of coach japan will serve to balance and cure out the mixture and give it the right drying ambition.

The third lead consists of white keg lead, and the other necessary pigments, thinned out to a working consistency with turpentine, and then given the elastic and binding element through the addition of a teaspoonful of raw linseed oil to each pint of the thinned mixture. Add by way of an insurance item—insurance against a possible check of the drying by virtue of weather conditions—a few drops of coach japan.

The fourth lead, in case such a body of lead becomes a necessity, should be mixed in quite the same way that we have provided for the third lead, except that the quantity of oil may be cut in two.

In the mixing of these lead coats there are two important, and, we might say, vitally essential factors to be observed. First, thoroughness in mixing. Second, accuracy of proportions. Inattention to either of these virtually defeats the purpose of the designer of the lead system of surfacing. We were taught, and we believe respect for the teaching has stood us in good stead many times since, to mix the lead to a stiff paste at least 24 hours ahead of actual use, after which the mass was tightly enclosed and set away to settle out and shape together. Then, when ready to use the lead, it was beaten out smooth and thinned to the desired consistency.

A pair of canvas gloves on the hands is better than a rag for washing a vehicle, as difficult parts and spokes may be easily reached.

GARDNER'S BRIDE AT "MOVIES" AS HE KEEPS OPEN HOUSE

The portals of the home of Russell E. Gardner, of the Banner Buggy Co., were thrown open for the celebration of his marriage under unusual circumstances in Alton, Ill., to Mrs. M. A. Simpson.

While Mr. Gardner entertained his men friends the bride passed the evening at a picture show.

The celebration was as impromptu as the wedding. One by one the bridegroom's friends dropped in and the host, with coat and formality thrown aside, entertained them with the details of the wedding.

"I just figured it out," said Mr. Gardner, "that it was not good for me to remain single any longer. You see, it has been several years since I was divorced, and here I had this large house and my three boys living here, and, as a matter of fact, I should have been married before.

"I had no such idea as getting married when I arose this morning. But I began thinking about it, and the more I thought the more I became satisfied I would be better off.

"I called Mrs. Simpson on the telephone and told her what I had decided, and I asked her if she would meet me in Alton today and marry me. She thought I was joking, but I assured her I was not, and she then told me she would.

"I went to my office, but I did not take any of my associates into my confidence. The only person in the factory to whom I spoke of the approaching wedding was my private secretary, and I bound her to secrecy before I told her.

"Then I directed her to write 25 telegrams, telling of the wedding, and I cautioned her not to send them until late in the afternoon, and to permit no one to know anything about it.

"Then I went to Alton, where I met Mrs. Simpson and we went to the new Mineral Springs Hotel, where we were going to be married. The hotel is not finished. We looked over the place, then went to the swimming pool.

"It was cooler here than any place in the hotel, and we concluded that was just the proper spot. And there we were married. And then we came home, and that is all there is to the story."

Mrs. Simpson lived at Clifton Terrace, near Alton, for ten years. She has been married before, but has no children. She gave her age as 31 and he gave his as 49 when they obtained their marriage license.

"The first Mrs. Gardner is married again," he continued, "and I hope and believe, happily. She is touring Alaska with her husband and I only hope she is as happy as I am."

Mr. Gardner's first wife, to whom he was married in 1885, obtained a divorce from him December 31, 1908. It was understood at the time that he had settled \$100,000 on her in lieu of alimony. Later she married Edward W. Greer.—St. Louis Republic.

WILSON SUCCEEDS HILLS

At a meeting of the directors making up the different boards of the Hercules companies, buggy, body, wheel, paint and gas engine, Mr. Fred Hills' resignation as director and secretary and treasurer, was accepted, and in his place was elected Frank R. Wilson as director and secretary and treasurer of each of these companies.

In regard to the resignation of Mr. Hills the following statement was made by Mr. McCurdy:

"The question as to why F. M. Hills has severed his connection as secretary and treasurer of the Hercules Buggy Co. has, on several occasions been put to us for answer, and to settle these inquiries, I desire to say that it is with deep regret that Mr. Hills has deemed it expedient to be relieved from his duties, and to further say, in this connection, that Mr. Hills' retirement is fully voluntary upon his part.

"He has been closely associated with us for over 20 years,

and all during that period has been a most loyal and efficient member of our organization.

"Two years ago, upon my return from Europe, Mr. Hills told me that he was not feeling physically up to normal and had about made up his mind to retire. I told him that I would not listen to such a course and that he should take a vacation for several months, with full pay, and when he felt fully recovered, to return and reassume his duties.

"He spent six months in California and returned in perfect health. The climate in California seems to have been just to his liking, and it is his desire to return there to live, consequently he has requested that he be fully relieved of his duties as secretary and treasurer of the company.

"He goes to his new home with the very best wishes of every official of the company."

HOTEL MONTICELLO

This hotel is exceptionally well equipped for the comfort of convention visitors demanding high class accommodations. Under the liberal ownership management of A. Conrad Ekholm during the past seven years, a reputation for efficient service, superior accommodations and fair treatment has been established for this hotel which has made it famous as Atlantic City's best and most popular hotel at moderate rates, celebrated for its elegant home comforts and cuisine of exceptional excellence.

The hotel is new throughout and accommodates 500 guests, is handsomely furnished and equipped with all conveniences, such as steam heat, elevator to ground floor, electric lighting, brass and enamel beds, local and long distance telephones, etc. Fifty of the front rooms are connected with private baths. The plumbing is exposed and of the most modern and sanitary character.

The table and service form a special feature and are already favorably known. The appointments of the dining room are dainty and elegant. Experienced white help is employed exclusively. Evening dinners are served.

It is a five minute walk from the pier where the convention and exhibition are held.

KNIGHT ENGINES FOR TRADE

The Moline Automobile Co. is going to build Knight sleeve valve motors for sale to the motor trade. The Moline company, while extending its activities in this way, will not drop its car manufacture, but will utilize the capacity of its plant, which will be 20,000 motors per year without any additions.

For the present, Knight sleeve valve motor activity will be confined to one model, a four-cylinder design, 4 x 6 in. bore and stroke, this being the same motor that so successfully went through the 336-hour test in January at the laboratory of the Automobile Club of America, New York. It is reported that a smaller size is at present going through the engineering department. Deliveries will be made practically immediately on the 4 x 6 in. size.

MOTOR WAR STATISTICS

In contemplating the possibilities of a European war, a lot of attention is paid to the use of aeroplanes and airships. While the former will doubtless be an important factor, it is certain that motor vehicles will play an even more important role, says an English publication. There are 100,000 pleasure cars in France, every one of which figures on the military registers, and about 75,000 of which are eligible to be called upon for military service at a moment's notice. In addition, there are probably 30,000 to 40,000 motor omnibuses, motor lorries, etc., many of which are already maintained under an army subsidy system, and all of which could be requisitioned if required. Further, there are about 37,000 motorcycles, all of which figure on the military registers, and three-quarters of which are eligible for service.

SIMPLE CIRCULAR SAW TABLE

The village builder and repairer can make use of machinery if it is simple, doesn't cost much, or if he can make most of it with his own labor. The description and illustrations that follow are from the American Blacksmith and should prove helpful.

In constructing the circular-saw bench, shown by Figs. 1 and 2, oak is the most suitable timber to use.

The frame is made as follows: Four legs, each 5 or 6 in. square, are planed up and mortised to receive the tenons of the side rails and end rails. A mortise is also made in the two top end rails, to receive tenons of a bearing piece that carries one of the spindle blocks. The four top rails are each 6x3 in., and the bottom rails are 4x3 in. All the stuff having been planed, and all the tenons made, glue and knock the frame snugly together. Bore a hole in each leg and drive four 3/4-in. bolts, A, through them, and tighten up by means of nuts as shown in Fig. 2. These bolts, passed inside the rails, tend to make the bench rigid. The saw spindle, B, runs in bearings C. The pulleys are shown at D, and E indicates the saw.

It will be seen that the saw end of the spindle runs in a bearing secured to a bearing piece. A long screw is also shown at F, for adjusting the fence. Three bearings are shown. The outside bearing is secured to a small horse, G. By adopting the third bearing the pull of the belt will not have such a wearing effect on the bearings, and it will also reduce the racking strain in the saw bench. The bearing piece referred to is shown in Fig. 3. The tenons fit snugly in the mortises made in the end rails, and are well wedged. The bearing block, C, is let down in this piece as shown, so as not to interfere with the table. The center bearing, Fig. 2, is let down likewise. Of course, the outside bearing may be dispensed with, but is preferred. If the third bearing is adopted, which is advised, a small horse, Fig. 4, should be framed together to carry the bearing. The bearings are secured by means of bolts passed down through the rails and screwed up from underneath, as shown in Fig. 3. Care should be taken that the bearings are in perfect line, or there will be trouble with the working of the saw, etc.

A plan of the table is shown by Fig. 5. The handpiece, H, is removable, and rests on two cleats secured underneath the table. The slot, J, receives a cleat secured to the base of the

fence. Underneath the handpiece and the table rabbetted pieces, Fig. 6, are secured for the length of the fore half of the saw. On these pieces are packing rests. The sawgate is indicated at K. The holes receive screws to secure the table to the frame. A saw spindle shaft may be 2 1/2 in. in diameter, and the total length (with three bearings) will be about 3 ft. 1 in., Fig. 7. The shaft should be turned down at C, so as to fit nicely in the bearings, and to prevent end-play.

At L, Fig. 7, a collar-washer is shrunk on the spindle, and a hole is bored and tapped in this washer to receive a steady-pin, M. This pin passes through a small hole in the saw-plate. A thread is cut at the end of the spindle shaft to receive the nut, N; the washer, W, being removable. To secure the saw on the spindle, remove the nut and the washer, pass the eye of the saw over the end of the spindle, then screw the washer tightly against the saw-plate. Care should be taken that these washers are turned perfectly true and slightly concave. If the washers are in the least degree convex, trouble will ensue. Fast and loose pulleys are shown respectively at O and P.

A front elevation of the fence is shown by Fig. 8, and may be made from 1 1/4-in. beech. By securing the fence to a base-piece by means of butt hinges it may be set to any angle. The two holes shown in the fence are to receive bolts to secure a false fence when smaller saws are being worked. The base-piece of the fence is shown by Fig. 9. To the underside of this piece a small cleat, as denoted by the dotted line, Q, is secured with screws. This cleat should fit nicely in the slot, J, shown in the table. See that the cleat is fixed perfectly square. A hole, shown in Fig. 9, is to receive a bolt that works on the adjusting screw. A winged nut screws on this bolt securing the fence to the table.

An enlarged end view of the fence, with an appliance for supporting it, is shown by Fig. 10. This appliance will also allow the fence to be set at any angle. The small iron bracket, R, has holes in it to receive screws securing it to the fence. The standard, S, is secured to the base of the fence with strong screws. A small bolt is passed through holes in the bracket and in the slotted piece, T, which secures it to the bracket. A bolt with a winged nut secures it to the standard. Two of these appliances are attached to the fence as described.

A bolt, Fig. 11, is passed through holes bored in the top rails, see Fig. 2. Iron plates are let in around these holes to prevent the wood wearing. A hand wheel, U, is keyed at one end; at

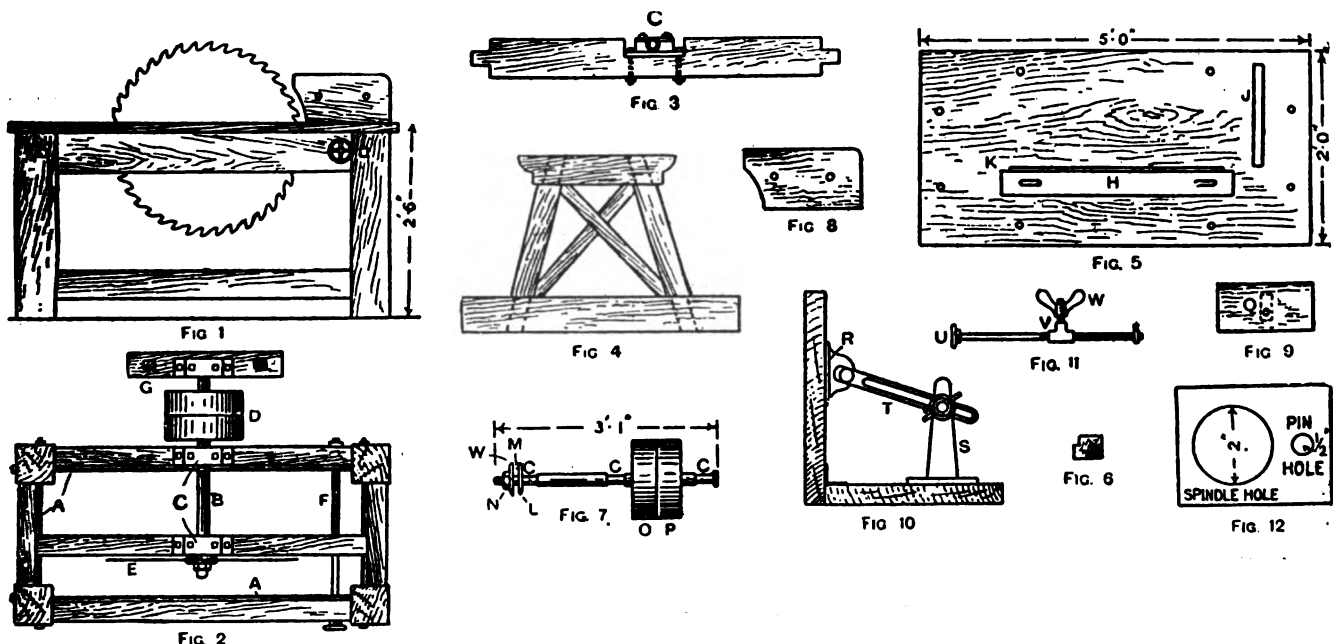

FIG. 1—SIDE ELEVATION. FIG. 2—PLANS OF FRAME. FIG. 3—BEARING AND BEARING SUPPORT. FIG. 4—END SUPPORTING HORSE. FIG. 5—TABLE. FIG. 6—PACKING PIECE. FIG. 7—SPINDLE. FIG. 8—ELEVATION OF FENCE. FIG. 9—BASE-PIECE OF FENCE. FIG. 10—ENLARGED VIEW OF FENCE. FIG. 11—ADJUSTING SCREW. FIG. 12—PIN AND SPINDLE HOLES

the other end a collar is secured as shown. A bolt, V, works on the thread of the long bolt. This little bolt is passed through the slot, J, in the table, and through the hole in the base of the fence shown by Fig. 9. A washer is then passed down over this bolt, and screwed down firmly by means of the winged nut, W, securing the fence to the table. By easing the winged nut and turning the hand wheel, the fence may be adjusted for cutting stuff of various thicknesses. Another method would be to use a piece of iron securely fastened to the base-piece and turned down over the front end of the table with a long tapped hole to receive a long bolt, Fig. 11, which is suspended in iron brackets secured to the legs of the bench. This method allows the fence to be thrown back when cross-cutting is being done.

When ordering circular saws, the exact sizes of pin and spindle holes should be sketched, as in Fig. 12, and the sketches sent with the order. A good speed for a 30-in. saw will be 1,050 revolutions per minute. If the first motion is very slow, put in a counter shaft, by which means the speed can be increased.

The dimensions of the bench here illustrated are suitable for saws up to 30 in. in diameter. If a drag motion is desired, bearings may be secured to the bottom rails to carry two small shafts, and brackets secured to the front and back legs of the bench to receive two small rolls to carry the timber that is being fed to the saw. The surface of these rolls should be a little above the surface of the table of the bench.

BODY WORK

One of the skillful operations in the construction of a motor body is that of making the doors and doorways. Those of the ordinary flush-sided touring cars are very conveniently made on the bench separate from the body and fixed in position when complete.

Design the working drawing of the job, showing the bottom-side on the transverse section square on the outer edge and reduced in width to allow the pillars to stand about $\frac{5}{8}$ in. thick at the extreme bottom.

Get out a template or pattern $\frac{3}{4}$ in. thick accurately to shape and size of pillars. See that the part that bears against the bottomside is plumb when the pillar has the correct layout and cut off the bottom to the true horizontal line with bottom of the body. Cut the half flap at the top for the elbow rail and mark the point of rocker. The pillars may then be marked out by the template dressed, and checks formed where required, and the recesses cut out for the rockers. A $\frac{1}{2}$ in. template is made for the rocker. The ends are square, the bottom flush with bottom of body, and the length $1\frac{1}{2}$ in. longer than the width of door way to fill the $\frac{3}{4}$ in. recesses in bottom and pillars. Cut out the rockers neatly to this template from 2 in. timber, face the ends and screw on the pillars in line with one another, then dress off to the pillars on all sides and continue the check to the bottom of doorway opening where it dies out. Ease off some of the bevel in the center of doorway to a suitable pitch and bore screw holes for fixing to bottomside.

The doorway is now complete. Begin the door by making a template of the bottom rail. It will take the same shape as the rocker. When accurately dressed mark and cut out the rails from 2 in. timber, fit to the rocker, put a cramp on at the center and mark the shape of the doorway inside and outside on to the rail and dress off.

Fit the door stiles in the same manner, and, while the cramp holds them, apply a straightedge on the inner face and strike lines on the face of the rocker. Remove the stiles and replace the rail and return the lines off the rocker up the face of the rail. Gauge for the half flap off the face of both rail and stiles. Cut away outside of rail and inside of stiles. Cut the half flap at top, also top rail, then put together with four cramps. Correct the shoulders with the tenon saw, and the door frame should be ready for glue. Clearance for the door is readily

made by cutting past the shoulder marks $\frac{1}{8}$ in. at the joints. If this is done the bottom clearance is simply a matter of keeping the door up while marking the position of the hinges. Locks and hinges can be fitted and the panel and lapping put on with safety. The door is made true, and the fact of the body being about 1 in. narrower at the front than the back gives to the doorway, when in position, the correct amount of wind to cause the door to strike at the bottom first when being closed.

Now the templates are made and a pair of doorways and doors to be built, it is simply a matter of selecting a 2 in. plank and marking out four pillars, four stiles off the same template. Two rockers and two door bottom rails (these cut into one another). Two top rails to length required ($1\frac{1}{2} \times 1\frac{1}{2}$ in.). Do all dressing and shaping to the templates.

TROUBLES NOT LAY-ED YET

F. B. Lay, Sr., former president of the Michigan Buggy Co. and one of the original owners of that concern, has been adjudicated a bankrupt by the U. S. district court at Grand Rapids.

A referee to take charge of affairs was not appointed by the court and it is understood that an effort will be made by Mr. Lay to effect a compromise. The former head of the Kalamazoo company fought against going into bankruptcy, but the creditors demanded a settlement.

Mr. Lay's name appears on much of the paper issued by the bankrupt company and his personal notes were given to protect the finances of the concern.

It is claimed that Mr. Lay will be forced to settle with the creditors where his endorsement appears on the back of the notes issued by the company prior to the crash.

VEHICLES IN CARTHAGE

A very well thought out folder that we have received from the Tyson & Jones Buggy Co., in Carthage, N. C., tells "A Business Story." The story is about the vehicle building industry in that thriving town, the history of this particular company.

We are glad to see such intelligent enterprise in the trade, as so few vehicle builders have awakened from a Rip Van Winkle advertising sleep.

IOWA CONVENTION DATES

Announcement is made by the implement and vehicle bureau of the Des Moines Chamber of Commerce that the dates for the annual convention of the Iowa Implement Dealers' Association this year are December 1, 2, 3 and 4. Secretary E. P. Armknecht, Donnellson, Ia., is arranging the program and the entertainment is being prepared by the local committee, who promise the best ever offered for the big annual gathering.

S. A. E. EUROPEAN TRIP POSTPONED INDEFINITELY

The Society of Automobile Engineers has postponed its second European trip indefinitely. The sailing date had been set around October 10 and the first stop was to have been Paris, but present war conditions have brought forth the postponement. The trip, as outlined, extended through France, Italy, Switzerland, Germany and England.

METZ EARNS \$1,000,000 IN 1913

One million dollars net was earned by the Metz Co., Waltham, Mass., last year, 10,000 cars at a profit of \$100 per car having been produced and distributed through dealers.

ARE WE OVER-PRODUCING?

A little satire can be detected in an editorial appearing in *The Automobile & Carriage Builders' Journal* under the above title and between the lines can be detected a prophecy that appeals. Read:

It would appear that the motor car manufacturers of the world have decided that it is the duty of all with the price of an automobile in their pockets to hasten to the nearest show room and possess themselves of one of the modern annihilators of distance. It is but a poor excuse to plead that one has already a car, or a dozen, since it is more than likely that the motor vehicles already owned are out of date, not speedy enough, or lacking in some function which makes the need for a new motor car an almost tragic necessity. Perhaps the salesman may take pity in the buyer who ventures the argument that he is really hard up, and that a new car may mean selling up his home, or going without cigars and wine, and will allow him to sell his old car so as to relieve the financial situation. But a new car must be acquired at all costs, for are not thousands of new ones being produced daily, and anything in the nature of a slump must be avoided at all costs? Irrepressible optimists may point out that these taunts are out of place, since there are still a far greater number of persons able to afford a car than there are cars on the market, and that over-production, even in the matter of more expensive types, is still a matter of the very dim future. The accessory manufacturer, who supplies hundreds of pounds' worth of fittings a month to his larger customers, and gets paid regularly for them, is naturally not inclined to be pessimistic, but some of those on whose shoulders rest the responsibility of selling the complete car may wonder occasionally if turnovers can be maintained in the years to come. The bicycle rose from obscurity to popularity in a short time, suffered a slump, and, at the present time, sells in ever-increasing numbers, in spite of other traveling facilities which have appeared in the meantime. The bicycle, however, is but a matter of a few pounds, and of late years it has become cheaper and anyone may possess a new mount for the outlay of a few shillings a month. The motor car, however, entails a more serious expenditure, and it must prove a mild shock to those who are wont to estimate the proportion of those in comfortable circumstances to discover that garages are almost as common as "sweet-stuff" shops. We think that the next few years will see the increase in popularity of cheap cars, while certain makes of a more expensive character will still receive a full measure of support, but there will be other makes of cars which will be lost sight of, since there will not be a sufficient number of buyers to go round, unless, of course, a scale of prosperity becomes established which will enable everyone to become a motorist and excite as little comment as if one possessed a garden roller or silver teapot. Other expensive articles, such as a grand piano, a house, or a brougham, are expected with care to last a lifetime, but a car is a well-tried veteran when it is ten years old, during which time one has saved a vast amount of traveling expenses such as occurs to the non-motorist, but also spent larger sums in upkeep. Still, we believe that the trade in motor cars has yet to expand, for there is always the commercial vehicle to consider, and it is quite likely that firms now devoting their attention largely to the pleasure side of the industry will manufacture vans and lorries. There was a time when a considerable percentage of manufacturers periodically announced large extensions to their factories. Today this particular form of excitement is for the favored few, but, at the same time, additions are being made to the number of firms engaged in some branch of the industry, which may not be a wise step in every case, or, on the other hand, a successful venture often leads to the downfall of a neighboring concern. It is everyone's business to make hay while the sun shines, and it is to be hoped that most of us will be able to see far enough ahead so that we may be well prepared for the probable altered conditions of trade.

S. A. E. A GREAT BODY

The Society of Automobile Engineers is nine years old. Compared with other technical organizations of its kind it is a mere infant in years, and yet a conservative and fair-minded appraisal of its accomplishments during these short years will convince any observer that it belongs to the class of infant prodigies.

In the number of members it compares favorably with societies decades old; in the quality of its membership it has no cause for apology. For the vigor with which the objects of the organization are pursued, its committees deserve the highest praise, and for the large benefits which have accrued to the industry as a whole, the society merits the heartiest thanks of automobile manufacturers.

When we speak of the accomplishments of this body, says Vice-president Zimmerschied, those who know anything at all of its history think immediately of standardization; and I believe we are all agreed that it is indeed fitting that standardization should have been first and foremost among its activities. Standardization is pre-eminently an American conception. It is indissolubly connected with the whole broad subject of efficiency, and certainly we American manufacturers accept no mean estimate of our ability to produce efficiently.

I have always had a keen personal interest in this subject of standardization—even for the bearing which it has on efficient production, but far more have I encouraged it on behalf of the user. The savings in time, money, trouble, and use of his car, which come to the owner through his ability to get standardized and interchangeable parts are simply enormous. If matters were still in the chaotic state that obtained when this society was formed, we can easily imagine the pygmy proportions that the automobile industry would have attained today!

I believe that a larger field awaits the Standards Committee in the elements of our cars. Bolts, clevises, carbureter fittings, and the like have already been standardized to excellent advantage.

The committee should not rest here, thinking its work done, but should consider the progress it has made in the light merely of a successful experiment. There are scores of other parts which may be considered elements in the mechanism, amenable to standardization. Choosing as typical of such parts, I would say that we all use pistons, piston pins, connecting rods, and crank shafts—can we not have standard types of all or some of these?

I do not mean to say that we will all use the same identical parts, but I do believe that standard type parts are feasible, provided these are based upon correct theory and successful experience. Of course, the standardization of such parts requires a large amount of intensive labor, but it ought to be labor well spent, because every hour spent at it will save many hours at a hundred drawing boards—if draftsmen will use these parts when standardized.

Exit Bootless Individuality

This brings up a phase of standardization work which should receive aggressive attention in the future—the enlarged use of standard parts, and the discouragement of bootless individuality. We hear at times of engineers who do not use standard fittings because they have something better. The committee is always glad to hear of such cases because it is made up of men big enough to admit that if some design is better than their standard they will be glad to consider it for a new standard.

But how many more engineers refuse to use standards simply because they want their design to be different! Why do not such engineers realize that meritorious individuality has to do with larger issues than original threads?

I submit that the automobile engineer would make far faster and better progress if he were furnished with many more standard parts and left free to bend his energies toward the larger issues in automobile design. He ought to realize that a sane and logical program of standardization does not mean a shack-

ling of his initiative, but rather that it would spell emancipation from the drudgery of too much detail. Henry Souther, chairman of the Standards Committee, puts it very tersely when he says that an engineer's value to a manufacturer consists to no small degree in his ability to use standards.

DONT'S TO AUTOISTS ON TOURS

Here are a few "don'ts" that are put down, which are likely to be valuable:

Don't wait till the gasoline is nearly gone before filling up. There might be a delay.

Don't allow the water can to be other than full of fresh water, and fill it every chance. You might spring a radiator leak or burst a water hose.

Don't allow car to be without food at any time. (List of eatables given.)

Don't buy oil in bulk. Buy one gallon original cartons.

Don't fail to have warm clothing. High altitudes are cold and dry air is penetrating.

Don't carry loaded firearms in the car, except possibly a small pistol.

Don't fail to put out your campfire when leaving.

Don't forget the yellow goggles.

Don't ford water without first wading through it.

Don't build a big fire for cooking. The smaller the better.

Don't drive over 25 miles an hour. Unexpected, small, dry washouts in the west will break springs.

Don't carry good clothes—ship them.

Don't wear leather puttees. Canvas is better.

Don't drink alkalai water.

Don't wear new shoes.

The above prepared by F. H. Trego, engineer Lincoln Highway Association.

OLD OIL AS GOOD AS NEW

Undoubtedly many engineers and those using lubricating oils are of the firm belief that when lubricating oils have been used for some time they are of little or no value. They frequently speak of oil wearing out and state that after it has been used for a time it should be thrown away and new oil substituted. A series of experiments was recently made to determine the worth of used oils.

Results of the tests showed that the purified oil from the filter has a slightly higher coefficient of friction at light loads, and slightly lower at heavy loads than the new oil. Similarly, the temperature, in which the user will no doubt be particularly interested, was practically the same for both oils. The difference between the two in no instance amounting to more than two degrees.

The question of physical change in the oil that has been used naturally arose. The tests showed that the flash point remained constant at 410 degrees F., the burning point decreased from 460 to 440 degrees; the specific gravity increased from 0.895 for new oil to 0.903 for the used oil. This rise in specific gravity was to be expected as some of the more volatile constituents were doubtless driven off when passing through the bearings. The viscosity test showed a higher viscosity for the old oil than the new, indicating that the oil gains in body as it is used over and over again, provided the filter thoroughly removes the entrained water. The general conclusions drawn from the test are that the used oil is as good a lubricant as the new oil.

INSTALLATION OF SPRINKLER SYSTEMS

The insurance committee of the National Implement and Vehicle Association has issued a circular announcement relative to the installation of sprinkler systems. In the circular the committee says that it is estimated by authorities that the average insurance rate on non-sprinkled risks average \$1 per

\$100, all over the country, and running up as high as \$100, or 10 per cent., while plants that have an approved sprinkler system installed are able to secure a rate of from 7 to 15 cents per \$100 on like property, so that the average plant can pay for the cost of installing a sprinkler system by the saving effected in from 3½ to 5 years.

The implement and vehicle business is of such a character that large amounts of finished stocks accumulate at certain periods of the year. This excess stock, of course, can be protected, as is the usual custom, by extra insurance. In case of fire, however, the insurance received would not compensate the owner for the loss of trade, due to his inability to replace his stock in time to supply the season's demand, while in a sprinkled plant it is practically impossible to have a conflagration, and the protection afforded is worth far more than the mere saving in the premium.

Companies that have had difficulty before their plants were sprinkled in keeping their lines full, and who at times were forced to accept policies in insurance companies of a second and third grade, will find that after installing the sprinkler equipment their insurance is sought after by companies of the highest grade, both stock and mutual.

The committee is prepared to place manufacturers in touch with the various companies that install the sprinkler equipments.

For the benefit of the companies that do not care to pay for the equipment at the time of installation, there are a number of companies who make it a business of financing such propositions, accepting for their pay the saving on the insurance premiums. The committee can put members in touch with those companies, which are thoroughly reliable.

COULDN'T PROVE IT

Claiming to have been maliciously prosecuted in the bankruptcy court, the Williams Wagon Works, of Macon, Ga., has brought suit against the Cottrell Saddlery Co.

It is alleged that the Cottrell Saddlery Co. employed the lawyers named in the suit to institute involuntary bankruptcy proceedings against the Works when it was known to them and to the attorneys that the company was solvent. At the time the wagon company owed the saddlery company \$800.

The Williams Wagon Works alleges that the bankruptcy case did much damage to its business, causing a loss of trade and the loss of credit at the banks. The bankruptcy petition was afterwards dismissed in the United States court, it is asserted, upon solvency being shown.

JOBBER OPENS RETAIL BRANCH

The Anderson Vehicle Co., Fond du Lac, Wis., implement and vehicle jobbers since 1875, has decided to open a retail branch in the same city. A full line of implements, vehicles and heavy hardware will be stocked. The retail store will be maintained entirely separate from the wholesale, and retail prices will be maintained. The new store will be under the management of J. L. Roblee, and the quarters will measure 80 x 200 feet, a full stock of samples to be displayed all year round. The company will be ready to make retail contracts in about 30 days.

WARSHIPS TO SOUTH AMERICA AS SAMPLE CASES

A resolution was introduced recently at Washington, D. C., by Senator Weeks, calling upon the Secretary of Commerce for information as to the cost and feasibility of sending six vessels of the United States navy with samples of American products to South American ports for the purpose of encouraging trade between the United States and the South American republics.

LEST YOU FORGET

Joseph Berg says the properly informed mechanic should know:

That sandpaper is graded numerically, the average being No. 1.

That a block should be used when sanding flat unfinished surfaces.

That sandpaper should be torn into rectangular pieces to fit the block.

That a sandpaper block should always be of soft wood.

That no sanding should be done until all tool work is finished.

That worn sandpaper becomes useful later.

To call a bit by name and size.

That a bit is not a bore.

That a bit is not a drill.

That the figure 9 on a bit means 9/16 inch, not No. 9.

That a brace it not an auger or borer.

That bits should never be filed on outside.

That direction should not be reversed when drawing out bit.

That a properly filed bit needs little pressure.

That holes are generally measured center to center.

That the use of a file be avoided wherever possible.

That grinding without water heats to a blue and destroys temper.

That sharpen does not mean grind.

That flat side of plane blade or chisel should never be raised when whetting.

To lay the plane on its side to avoid dulling blade and cutting the bench.

That a modern iron jack-plane is not a scrub-plane, as the old wooden one was.

That a rip saw differs from a cross-cut saw.

That the number on a saw indicates number of teeth per inch.

That a rip saw is not always numbered 8 and a cross-cut saw, 10.

That the back saw be reserved for close work.

That it is necessary to have a line squared across two adjacent faces to cut off square.

That no time or labor is saved by sawing around the piece.

That a large chisel will do better work than a small one.

That chiseling across the grain is possible and correct in many cases.

That a mallet should not be used except for heavy work.

To watch the chisel edge, not the handle, when using mallet.

That a bevel should not be called bevel square.

That gauge and square are useless if not used properly.

That the gauge point should be filed like a knife edge and should cut a line.

That the gauge should be tilted slightly in direction of motion.

That a screwdriver should never be sharpened like a wedge.

That screws should never be driven without first boring through the top piece.

That a vise will hold the work without placing entire weight on the handle.

That shellac does not dry in half hour as is generally believed; it merely sets.

That a loose joint with much glue is weaker than a tight one with less glue.

That a thick glue is worse than none.

That shellac must be thin and applied quickly.

WOOD-WIRE WHEEL TEST

Completing 60,772 tire-miles, the test held by the Automobile Club of America for the purpose of denoting the relative merits of wire and wood wheels, as related to tire wear, has ended with little actually determined except the staying qualities of the pneumatic tires employed. The test was held under the supervision of the laboratory engineer of the club.

The test started on March 31 when two automobiles left the Automobile Club of America, one equipped with wood wheels and the other with wire. The cars were operated over the roads of New York City and vicinity until the vacuum cup tires with which they were fitted, wore out. Altogether there were nine tires used in the test, one of which did duty on both the wire wheel and wood wheel car, and therefore cannot be considered in making up resulting figures.

On the wood wheels the four tires which went throughout the test made 5,700, 7,500, 8,940 and 10,164 miles, an average of 8,078.

On the wire wheels the tires made 5,820, 4,300, 9,220 and 6,540 miles. This gives an average of 6,107 miles. The tires were frequently changed from wheel to wheel on both cars.

On the surface this would seem to give an enormous difference in favor of the wood wheels, but such is not the case, as the tires on the wire wheels were subject to accident in the early periods of the run, thereby causing them to blow out sooner than would have been the case were they subject to ordinary wear. In fact, out of the nine tires used, but two perished through being worn out, one of these traveling 10,164 miles and the other 9,228. One of these was on the wood wheel and the other on the wire, showing a difference that cannot be compared owing to the fact that it was a single isolated instance, offering no basis for accurate comparison.

The ninth tire traveled 2,660 miles, at which time it blew out, owing to a cut it had received at the end of the 1,040th mile. As this tire had traveled this distance on the wood wheel, and after being repaired had been transferred to the wire wheel car, it cannot be reckoned in the comparison of mileages.

LIDLAW OPENS DETROIT OFFICE

So that it may keep in closer touch with its growing Michigan business, W. R. Laidlaw, Inc., New York City, has opened a branch office in Detroit. It is located in the Goldberg building. J. H. Johnson, who long has been with the Laidlaw company, will be in charge.

BLEEG TRUSTEE

John Blegg has been appointed trustee of the South Dakota Plow and Wagon Co., at Sioux Falls, by the court and now has the property in hand. The troubles of this company have been in court for some time and instead of throwing the property into a receiver's hands it was decided to appoint a trustee.

GET NEXT THE CHAMBER OF COMMERCE

Consul Nathan in Turkey is sure that in a number of cases orders for American goods have resulted from the connection of local business houses with the American Chamber of Commerce for the Levant. While the American consulate co-operated in two specific instances, the chamber was directly responsible for the orders; one was an order for a dozen buggies.

RUTHERFORD TIRES

Middleton & Sharpe, Rutherford, N. J., will build a plant for the manufacture of rubber tires.

BAY CITY CO. ERECTING

Stroud, Bridge & Connors, Bay City, Mich., will erect a two-story factory, 90 x 110 feet, for the manufacture of automobile accessories.

Prather Bros., Georgetown, Ky., have leased a building and will equip it with wood and metal working machinery for the manufacture of a demountable automobile wheel.

CHANGES IN FREIGHT RATES

Changes in freight rates on farm wagons, vehicles, etc., filed by various transportation lines with the Interstate Commerce Commission, together with dates on which they take effect, follow, the rates named being in cents per 100 pounds.

Central Freight Association, supplement 2 to I. C. C. No. 471, August 25, farm wagons, to shipside at Algiers, Gretna, New Orleans, Port Chalmette and Westwego, La., Port Arthur, Port Bolivar, Texas City and Galveston, Tex., Gulfport, Miss., and Mobile, Ala. (when designated to South America), from La Port and Richmond, Ind., 27c.

M. & St. L. Railway, supplement 10 to I. C. C. No. B-18, September 1, wagons (not pleasure or passenger vehicles) and parts thereof, when loaded in box cars, farm wagons and parts thereof; farm trucks and parts thereof; shoveling boards, wagon seat springs; from Oskaloosa, Ia., to Sioux Falls, S. D., 27 3/10c.

Great Northern Railway, supplement 18 to I. C. C. No. A-3640, September 1; wagons (not pleasure or passenger vehicles) and parts thereof; farm wagons, trucks, seat springs, shoveling boards; from Beaver Dam, Beloit, Evansville, Fort Atkinson, Horicon Junction, Stoughton, Watertown, Wis., Byron, DeKalb, Dixon, Forreston, Freeport, New Boston, Rochelle, Rock Falls, Rockford, Rockton, Sterling, Stillman Valley, Sycamore, Ill., and points of origin subject to same rates to Aberdeen, S. D., 42c; Breckenridge, Minn., 37c; Fairmont, N. D., 35c; Fargo, N. D., 37c; Graceville, Minn., 35c; Hutchinson, Minn., 26 1/10c; Moorhead, Minn., and Wahpeton, N. D., 37c. From Ottumwa, Ia., to Fairmont, N. D., 35c; Ellendale and Forbes, N. D., 41c; from Winona, Minn., to Duluth, Minn., and Superior, Wis., 23c; from Chicago, Ill., and Brulington, Ia., to Albee, S. D., Bellingham, Danvers, Holloway, Minn., La Bolt, S. D., Louisburg, Nassau, Minn., and Stockholm, S. D., 35c.

RETURNED GOODS

At a recent meeting of the National Implement and Vehicle Association, consideration was given to the promiscuous returning to the factory or branch house of goods not defective without order or consent. From the standpoint of economy in the costs of distribution and justice it was considered that rules should be formulated to cover this practice. A committee was appointed to investigate and report later with the expectation of bringing the matter to the attention of the Federation of Dealers' Association.

TRAILED TO GOSHEN

Through the efforts of the Commercial Club of Goshen, Ind., the American Auto-Trailer Co., formerly of Waterloo, Ia., is

moving its plant to Goshen. The firm manufactures a two-wheeled truck. S. C. Cook, of Philadelphia, and H. E. Over-smith, of Brooklyn, Mich., are the controlling stockholders of the concern.

PARKER AND THE TIGER CO.

F. M. Parker, well known to Iowa and Wisconsin dealers, has joined the selling organization of the Tiger Vehicle Co., of Freeport, Ill. Mr. Parker will work in Wisconsin for the coming season. He was formerly with the Durant-Dort Carriage Co., of Flint, Mich., for whom he traveled in both Iowa and Wisconsin. Mr. Parker for the last year has been in business for himself in Chicago, but disposed of it.

FINE METAL GOODS

The Central Mfg. Co., Connersville, Ind., is one of the concerns that has done and is doing fine work in seats and bodies, and the one-piece work is being widely popularized by the examples turned out by this shop. Just the designs the wholesaler hankers after, and just the goods that have the everlasting stamp on them.

Look them up, and see something nice and workmanlike.

REMOVING TIRE VALVE WITH A COTTER

Where a valve cap is lost on a pneumatic tire the valve may be easily removed by the use of a small cotter. The cotter is placed in the valve and turned with the fingers. In case of a tightly fitting valve, insert a nail in the eye of the cotter for a handle.

FACTORY EXTENSIONS

J. E. Rhoads & Sons, tanners and manufacturers of leather belting, Wilmington, Del., will soon begin an addition to the main building of their tannery.

The Auburn Wagon Co., of Martinsburg, W. Va., have issued an office poster for dealers that will be found of value, from the fact that it is attractive. Customers in looking at it will be bound to see some vehicle that appeals to them.

The Tiffin Wagon Co., of Tiffin, O., makers of farm wagons, dump wagons and municipal wagons, such as sprinklers and flushers, have added motor trucks to their line.

The Eureka Company, Rock Falls, Ill., announces the engagement of Glen Nelson, Lena, Ill., to handle the company's line of vehicles in southern Wisconsin.



Hotel Dennis, Atlantic City, N. J.

EXPIRED PATENTS

The following list of patents, trade marks and designs of interest to our patrons are furnished by Davis & Davis, solicitors of American and foreign patents, Washington, D. C., and St. Paul Building, New York City.

Expired June 8, 1914

- 583,887—Automatic Wagon Brake. Cassius C. Calhoun, Windsor, Mo.
 583,909—Thill Coupling. David C. Kitching, Gatesville, Tex.
 583,919—Vehicle Step. Sylvester S. Mohrman, St. Louis, Mo.
 583,971—Thill Coupling. Charles Barr, Ashland, O.
 583,988—Ball-bearing Axle. Andrew C. Farnsworth, Chicago, Ill.
 584,090—Farm Wagon. Benjamin F. Kent, Franklin, Ore.
 584,108—Wheel Tire. William Corliss, Providence, R. I.
 584,115—Pneumatic Tire. Thomas B. Jeffrey, Chicago, Ill.
 584,125—Vehicle Gear. William Atkins, Auburn, N. Y.
 584,125—Vehicle Axle. George Greenslee, Jr., Belvidere, Ill.
 584,141—Wheel Hub. Jean B. Garand, Montreal, Canada.
 584,163—Manufacture of Pneumatic Tires. James F. Lawrence, Chicago, Ill.
 584,167—Attachment for Delivery Wagons. Calvin Shanklin, Des Moines, Ia.
 584,193—Pneumatic Tire. John C. Raymond, New York City.
 584,277—Wooden Felly for Vehicle Wheels. George Tyler, Clarksburg, Can.

Expired June 15, 1914

- 584,347—End Gate. Patrick O. Gorman, Jerseyville, Ill.
 584,468—Thill Holder. John Fatka, Racine, Wis.
 584,498—Pneumatic Tire. Samuel F. Ettinger, Little Rock, Ark.
 584,680—Vehicle-axle Box. Cornelius S. Felumley, Nashport, and Rodolphus M. Fink, Irvile, O.

Expired June 22, 1914

- 584,786—Wagon Dump. George D. Langdon, Homer, N. Y.
 584,838—Ball-bearing Vehicle Hub. Charles M. Andrews, South Bend, Ind.
 584,486—Wheel and Axle Lathe. Harry C. Bocquet, Hereford, England.
 584,881—Safety Attachment for Pole Yokes. Bessie Larsen, Ruthven, Ia.
 584,884—Carriage-bow Support. Charles F. Lydon, James R. Lydon and James B. Perkins, Lewiston, Idaho.
 584,935—Cushion Tire. Rebecca H. Hayes, Galveston, Tex.
 584,971—Vehicle Seat and Top Support. Herman H. Uckotter, Cincinnati, O.
 584,995—Storm-apron Case for Vehicles. William Fetzer, Sheldon, Ia.
 585,148—Thill Coupling. Humphrey B. Young and John N. Young, Brockville, Canada.

Expired June 29, 1914

- 585,180—Thill Coupling. William V. Breene and Edward W. Brown, Port Chester, N. Y.
 585,209—Vehicle Brake. Charles H. Inman, Batchtown, Ill.
 585,278—Hub-securing Device. Alexander C. Morris, Moab, Va.
 585,363—Vehicle-wheel Bearing. Charles E. Roberts, Oak Park, Ill.
 585,388—Wheel Rim. John H. Kydd and John B. Mitchel, Bowmansville, Canada.
 585,391—Neck-yoke Lock. George A. Marquet, Troy, N. Y.
 585,396—Road Vehicle. Joseph A. McNeil, Boston, Mass.
 585,418—Pneumatic Tire. Charles F. R. A. H. Bagot, London, England.
 585,615—Pneumatic Tire. Charles F. R. A. H. Bagot, London, England.

Expired July 6, 1914

- 585,654—Thill Coupling. James E. Cryderman, Troy, Wis.
 585,660—Thill Coupling. Victor Dumas, Jr., and Adam Knapp, Jr., Java, N. Y.
 585,745—Whiffletree. Chancy A. Gaylord, Bassett, Ia.
 585,768—Wagon or Other Vehicle. Edgar W. Loomis, Elgin, Ill.
 585,997—Old Tire Setting Machine. Edward N. Zeller, Portland, Ore.
 585,948—Dumping Wagon. William Beckert, Reserve, Pa.
 586,026—Spring Wheel for Vehicles. Ellis D. Greene, Barry, Ill.

Expired July 13, 1914

- 586,138—Means for Fastening Spokes to Vehicle Wheels. Alexander P. Morrow, Elmira, N. Y.
 586,267—Wheel for Vehicles. Mark D. Goodwin, Philadelphia.
 586,271—Buggy-top Attachment. Willis W. Krutsch, Coffeyville, Kas.
 586,300—Machine for Shaping Wooden Rims. Charles H. Cowdrey, Fitchburg, Mass.
 586,440—Wagon Standard. Julius G. Kernek and Henry E. Kernek, Poplar Bluff, Mo.
 586,542—Vehicle Spoke. Emery Brule, Neillsville, Wis.

- 586,548—Hub for Vehicle Wheels. Harry L. Eaton, Manlius, N. Y.

Expired July 20, 1914

- 586,670—Fifth Wheel for Wagons. Matthew M. Sherwood, Scranton, Pa.
 586,765—Means for Securing Tires to Vehicle Wheels. Albert B. Friedrich and David O. Eustice, Livingston, Wis.
 586,777—Elliptic Spring. Targe G. Mandt, Stoughton, Wis.
 586,911—Fifth Wheel for Vehicles. James McLaughlin, Ovid, Mich.
 586,969—Automatic Wagon Brake. Henry A. Hibbard, Evergreen, Pa.
 587,009—Pneumatic Tire. Louis J. M. Loisel, Tergnier, France.
 587,035—Tire-setting Machine. Phillippe D. Dupont, St. Johnsbury, Vt.

Expired July 27, 1914

- 587,075—Pneumatic Tire. Alfred H. Crockford, Dartford, Eng.
 587,078—Draft Attachment for Vehicles. Archie MacAlpine, Williscroft, Canada.
 587,175—Seat for Vehicles. John Q. Black, Lone Rock, Wis.
 587,180—Wagon Brake. Abraham W. Burkholder, Pleasant Hall, Pa.
 587,191—Vehicle Wheel. William T. Faizey, Astley Abbots, England.
 587,238—Tire Tightener. John G. Sarter, Fort Logan, Mont.

Expired August 3, 1914

- 587,307—Wheel. Emanuel Griffith, Trion Factory, Ga.
 587,355—Antirattling Thill Coupling. William Abraham, Fairchild, Wis.
 587,411—Hub-attaching Device. Adoniram J. Walker, Dalton, Mass.
 587,440—Thill Coupling. Andrew C. Kane, Peoria, Ill.
 587,513—Neck-yoke Coupling. Charles Shuman, St. Louis, Mo.
 587,544—Elastic Tire. Bernard H. Chameroy, Le Vesinet, France
 587,566—Wagon End-gate. John Windler, Jr., and Louis Windler, Canton, Kas.
 587,596—Vehicle Brake. John F. Murphy, Adrian, Mich.
 587,644—Thill Support. John C. Coffee, Decatur, Ind.
 587,671—Rawhide Tire and Process of Making Same. Otto A. Hensel, Pittsburgh, Pa.

W. A. EBBERT WITH KENTUCKY COMPANY

W. A. Ebbert, well known in the farm wagon industry, has been engaged by the Kentucky Wagon Mfg. Co., Louisville, Ky., as manager of the dump wagon department. He has devoted his business life to the wagon line and has a wide experience in both the manufacturing and selling ends of the business.

FORD BUYS PLOT IN BROOKLYN

The Ford Motor Co., Detroit, has purchased a site in Brooklyn, on which will be erected a six-story brick and steel sales-room and service station. Plans have been filed for enlarging the Long Island City plant by an eight-story addition, to cost \$650,000. When the dicker was on for this real estate it was rumored that Ford was to build a cheap electric car.

TO BUILD LARGEST PLANT IN U. S.

The American Aluminum Co. has announced the purchase of a \$400,000 strip of land in Edgewater, N. J., as a site for a \$2,000,000 plant to be erected. It will be the largest aluminum manufacturing plant in the United States, it is said, and will employ from 2,000 to 3,000 men.

HOLIHAN CO. MOVES

The Holihan Mfg. Co. has removed to its new plant on Jefferson avenue, west, and 21st street, Detroit, Mich. This concern manufactures radiators, hoods, tanks and fenders.

RIM CONCERN BUILDING

The Lookout Bending Co., Chattanooga, Tenn., will erect a plant at Sulphur Springs, Ga., to manufacture automobile wheel rims and spokes.

Trade News From Near and Far

BUSINESS CHANGES

Kearney, Neb.—W. Madgett sold out.
 Thurston, Neb.—T. J. Colligan sold out.
 Ulysses, Neb.—C. Field sold to W. Spelts.
 Glidden, Ia.—E. O. Potter sold to O. Mundt.
 Summit, S. D.—J. N. Shuler sold to O. Melby.
 Centuria, Wis.—J. Elliott sold to Levi Lumsden.
 Louisville, Neb.—D. Devries sold to J. L. Wells.
 Shelton, Neb.—C. S. Bailey sold to A. J. Ulrich.
 Olivet, Mich.—A. H. Covey sold to G. C. Adams.
 Pecatonica, Ill.—W. J. Bucklin sold to H. Meyer.
 New Sharon, Ia.—J. A. Watland sold to D. Shelly.
 Eagle Grove, Ia.—O. F. Gunderson sold to Ed. Hirt.
 Mansfield, Wash.—Leslie & Robbins sold to Z. V. Leslie.
 Duncan, Neb.—Thomas & Thomas sold to Frank Thomas.
 Hancock, Ia.—R. J. Martin sold to Van Beck & Everhart.
 Washburn, N. D.—C. W. McGary sold to Frank Swanson.
 Osakis, Minn.—Anderson Bros. sold interest to W. Baker.
 Forman, N. D.—Wallock & Dyste sold to Wallock & Dada.
 Wilboux, Mont.—Chappell & Co. sold to Rife & Vanluchane.
 Cleveland, O.—Winton Motor Carriage Co. changed to Car Co.
 Freeport, Ill.—Tiger Vehicle Co. replaces Freeport Carriage Co.
 Painesville, O.—Vulcan Carriage Co. changed to Vulcan Car Co.
 Beltrand, Minn.—J. O. Hannessohn sold to E. W. Johnson & Co.
 Omaha, Neb.—Opper-Van Fleet (autos) sold to Noyes & Clark.
 Oregon, Mo.—Burrier & Ramsey bought R. Smith buggy stock.
 Clarksville, Mo.—Middleton & McGinn sold to G. W. Middleton.
 Sherry, Wis.—Sherry Hardware Co. sold half interest to Henry Osenga.
 Laurel, Mont.—G. Lourie purchased vehicle stock of Laurel Implement Co.
 Salem, Mass.—G. Andrews carriage factory sold for machinery plant to Merrow Machine Co.

NEW FIRMS AND INCORPORATIONS

Avoca, Ia.—T. H. Straub.
 Fairview, Kas.—L. Miller.
 Marcus, Ia.—C. C. Iverson.
 Leon, Ia.—E. W. Hamilton.
 Bluemound—H. A. Schnelle.
 Merkel, Tex.—G. F. West Co.
 Nassau, Minn.—David Woulfe.
 Belvidere, Neb.—J. E. Reinholtz.
 Savannah, Ga.—Atlantic Motors Co.
 Nebraska City, Neb.—Jno. D. Ford.
 Central City, Neb.—Chas. Anderson.
 Maple Plain, Minn.—O. Styner & Sons.
 Charleston, S. C.—A. R. Tomlinson Co.
 Detroit, Mich.—Walker Wagon Co.; \$3,000.
 Columbus, O.—Capital Motor Co.; \$10,000.
 Charlotte, N. C.—Auto Supply Co.; \$10,000.
 Ft. Wayne, Ind.—Overland Auto Co.; \$15,000.
 Persia, Ia.—Becker, Sedden & Brown (garage).
 Detroit—Aetna Motor Truck Sales Co.; \$5,000.

St. Louis—Laclede Auto & Supply Co.; \$50,000.
 Clarissa, Minn.—G. T. Morey and J. T. Nutting.
 Birmingham, Ala.—Brownell Auto Co.; \$10,000.
 Covington, Ky.—U. S. Motor Truck Co.; \$25,000.
 Alexandria, Va.—Palace Automobile Co.; \$15,000.
 Dade City, Fla.—E. E. Henderson, wagon factory.
 Orange, Tex.—Orange Buggy & Imp. Co.; \$30,000.
 St. Joseph, Mo.—National Spring Wheel Co.; \$100,000.
 Detroit, Mich.—Spranger Rim & Wheel Co.; \$100,000.
 Kansas City, Mo.—Standard Motor & Mfg. Co.; \$10,000.
 Hot Springs, Ark.—Acme Device Mfg. Co., (vehicle top raiser).
 Chicago—Chicago Wheel Co.; \$2,500; to make and repair wheels.

IMPROVEMENTS AND EXTENSIONS

Bucyrus, O.—Seeger Bros. enlarging plant.
 El Paso, Tex.—S. Brown erecting \$10,000 building.
 Cleveland, O.—Gustav Schaefer Wagon Co.; new four-story factory.
 New York City—A. Scholl is erecting four-story factory for \$25,000.

FIRES

Ottawa, Can.—Watson Carriage Co.; \$15,000.
 Los Angeles, Cal.—Drew Carriage Co.; \$4,000.
 Hubbell, Neb.—Thomas Bros. stock destroyed.
 West Elkton, Pa.—Talbert Carriage Co.; \$20,000.
 Harriman, Tenn.—N. C. Blanchard, spoke factory; \$10,000 loss, partly insured.

MARSH TO MAKE LIGHT CAR

A. R. Marsh, Anderson, Ind., formerly connected with the Vulcan Mfg. Co., Painesville, O., maker of the Vulcan car, has disposed of his interests in that company, which he organized and whose product he designed. He will enter the field of lighter, lower-priced cars. The new car will be called the Caesar.

FROST GEAR AND BAKER FORGE MERGER

The Frost Gear & Forge Co., Jackson, Mich., has increased its capital stock to \$300,000, nearly all of which is paid in. Arrangements have been made to take over the affairs of the Baker Drop Forge Co., Jackson, and the two concerns thus merged will be known as the Frost Gear & Forge Co.

HAGERMAN QUITS HERCULES

W. M. Hagerman, for several years traveler in Iowa for the Hercules Buggy Co., with headquarters at Des Moines, reports that he has tendered his resignation to take effect August 1, after which time he will be in the service of the Tiger Vehicle Co.

NEW KANSAS CITY BUILDING

The Republic Tire Co. is completing new quarters at 1813 Grand avenue and the Federal Rubber Co. is preparing to move into its new building at 1825 McGee street.

OBITUARY

William White, well known to the vehicle trade, and a resident of Rock Island, Ill., died August 12, age 68 years. He had been confined to the hospital since early in May. The deceased went to Moline in 1887 where he was for five years actively engaged in the manufacturing department of the Wilson-Moline Buggy Co. After the organization of the Rock Island Buggy Co. he was the principal sales representative for Iowa. Since leaving that concern he had been the sales representative in the same territory for the George White Buggy Co. He was one of the best known men in the Iowa territory and was highly regarded by all with whom he came in contact.

WILLIAM W. ECCLES

William W. Eccles, treasurer of the Richard Eccles Company, of Auburn, N. Y., died August 16 at his summer home on Owasco Lake, after a long illness. Mr. Eccles was connected with the Richard Eccles Company for about 20 years, having charge of the manufacturing department of the plant.

William W. Eccles was the son of Richard Eccles, who founded the company. He received his earlier education in the public schools of Auburn and finished his studies at Yale. Later he became associated with his father and after a short time, became a member of the firm.

Besides his wife, a daughter and two sons, he is survived by his parents, Mr. and Mrs. Richard Eccles, two sisters, and one brother, Edward H. Eccles, of Auburn.

PIONEER POLE AND SHAFT ADDS

The Pioneer Pole & Shaft Co., of Piqua, O., has acquired the W. H. Gillette Mfg. Co., of Louisville, with a plant covering about four acres. The consideration is said to have been in the neighborhood of \$120,000. Negotiations for the transfer, it is said, have been on for some time between W. H. Gillette, president of the Louisville company, and representatives of the Pioneer company.

E. B. Freeland, formerly manager of the Cincinnati branch of the Pioneer company, and who resigned that office to come with the Gillette company, has been placed in charge of the Louisville plant.

The W. H. Gillette Mfg. Co. was established in Louisville some twelve years ago by Mr. Gillette, who began in a small way. Mr. Gillette has not announced his plans for the future.

FLINT EMPLOYING MORE MEN

According to an investigation made in the Flint, Mich., plants there were about 2,700 more men employed in these plants July 1, of this year, than on July 1, 1913, and judging from the increasing business there will be more men employed by the end of the year than during any previous year. In January there were about 170 less men employed in the various plants than in January, 1913; in February there were about 200 more than last year; in March the increase had reached about 900 men, and it has been increasing ever since, until now when about 12,000 to 12,500 men are being employed all told. In most of the factories it is stated that the season is about 60 days ahead of last year's.

U. S. TRUCK IN COVINGTON

The United States Motor Truck Co., Covington, Ky., has filed articles of incorporation. It has a capitalization of \$250,000. R. C. Stewart and others are the incorporators, and it is understood that the plant of the Stewart Iron Works in Covington will be used temporarily for the manufacturing operations.

WANTS

Help and situation wanted advertisements, 1 cent a word; all other advertisements in this department, 5 cents a word; initials and figures count as words. Minimum price, 30 cents for each advertisement.

PATENTS

Patents—H. W. T. Jenner, patent attorney and mechanical expert, 606 F St., Washington, D. C. Established 1883. I make a free examination and report if a patent can be had and exactly what it will cost. Send for circular.

SITUATION WANTED

Situation wanted as carriage painter, by an all round man in paint shop; wishes job in small custom shop in country town. Box 29, care The Hub, 24 Murray street, New York.

MOVES CHICAGO OFFICE

The Sheldon Axle Co., Wilkes-Barre, Pa., has removed its Chicago office to the People's Gas Building, Michigan Boulevard.

INDEX TO ADVERTISERS

Baltimore Hub-Wheel and Mfg. Co.....	40
Cargill Company, The.....	40
Central Mfg. Co.....	3
Columbus Bolt Works.....	4th cover
Correspondence School of Carriage and Motor Drafting...	39
Cumberland Hotel.....	2d cover
Dennis Hotel.....	2d cover
Dowler, Chas. L.....	40
Du Pont Fabrikoid Co.....	39
Eccles, Richard, Co.....	2
Fairfield Rubber Co.....	3d cover
Gifford, John A., & Son.....	2
Jones & Co., Phineas.....	3d cover
Keystone Forging Co., The.....	39
Keystone Paint & Filler Co.....	3d cover
Lawson Co., F. H., The.....	3d cover
Masury, John W., & Son.....	2d cover
Meyer, John C., & Co.....	40
Miller Bros.	40
Monticello Hotel	2
Mulholland Co., The.....	40
Murphy Varnish Co.....	4
National Spring & Wire Co.....	4th cover
Payne Co., E. Scott.....	40
Porter, H. K.....	2
Sheldon Axle Co.....	2
Sidney Mfg. Co., The.....	1
Skinner Bending Co., The J. M.....	40
Standard Oil Cloth Co.....	38
Technical School for Carriage Draftsmen and Mechanics..	40
Virginia and North Carolina Wheel Co.....	4th cover
West Tire Setter Co.....	3d cover
White-Quehl Mfg. Co.....	40
Wilcox Mfg. Co., D.....	1
Willey Co., C. A.....	4th cover

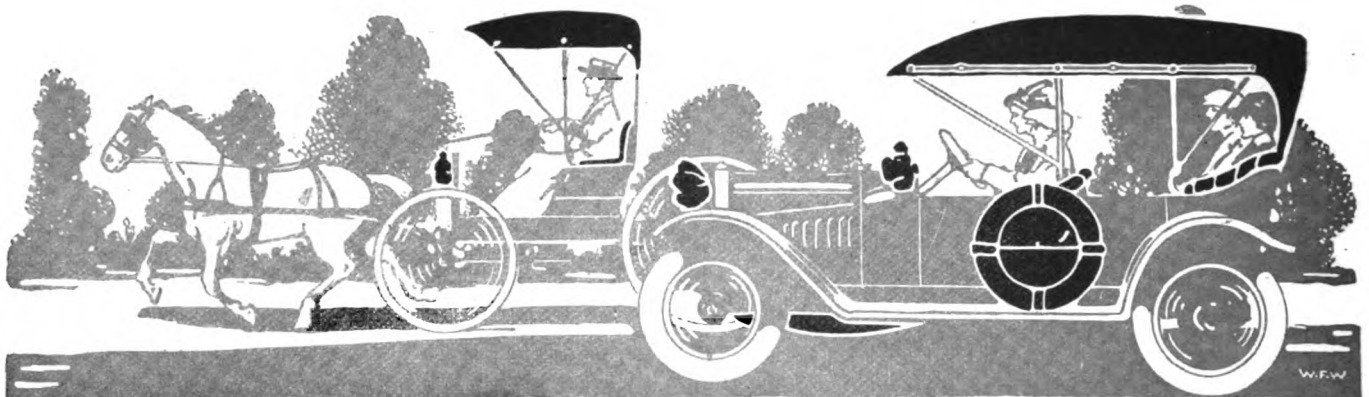

Learn More About The Leading Leather Substitute

Every carriage and automobile manufacturer—every manufacturer of carriage and auto accessories, storm curtains, aprons, lamp covers, tire cases, trunks, etc., should get and examine samples of

MERITAS LEATHER CLOTH

Only by seeing the goods—by testing them—by noting the handsome, durable, non-cracking finish and the fine line of colors can you appreciate the high quality we have attained in the manufacture of a serviceable leather substitute.

There are styles, colors and finishes in MERITAS LEATHER CLOTH suitable for every carriage and auto trimming and upholstery purpose.

It can be had in muslin, duck and drill; dull or glazed; smooth or grained; in black and colors.

Sample book on request—write now and know more about the leading leather substitute.

Write
for
sample
book of
MERITAS
LEATHER CLOTH

NOW

Standard Oil Cloth Co.

320 Broadway, New York

USE

F. DU PONT FABRIKOID
REGISTERED

MOTOR QUALITY
FOR UPHOLSTERING

REDUCE upholstering costs. Cut your covers from a Fabrikoid roll—use every inch of the material. Save the 25% waste of the irregular coated split.

MORE HASTE—LESS WASTE

in the upholstery shop where Motor Quality Fabrikoid replaces coated splits. The former has double the strength of splits—stands the pull and strain without splitting. Your upholsterers can do more, and the vehicle becomes more attractive and salable with Motor Quality Fabrikoid.

Motor Quality Fabrikoid is guaranteed superior to any other artificial leather made—including coated splits.

STATE INTENDED USE
AND WRITE FOR SAMPLES

DEPARTMENT 269
DU PONT FABRIKOID CO.
WILMINGTON, DELAWARE
TORONTO, ONTARIO

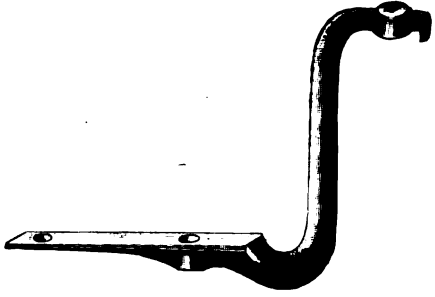

**BODY
LOOPS**

**ALL
SIZES
ALL
STYLES**

MANUFACTURED BY
The Keystone Forging Co.
Northumberland, Pa.
WRITE FOR PRICES

Established 1886

**Correspondence School of Carriage and Motor
Carriage Drafting**

A thorough, practical tuition is given through this correspondence school. The theory and practice of construction, bookkeeping, perspective. Many men now hold good positions through taking the courses of instruction.

Principal, THOS. MATTISON,
Hillside Avenue, Bitterne Park,
Southampton, England

Author of "The Coach Body Makers' Guide," \$3.00; a practical treatise on "The Suspension of Carriages," "Bookkeeping," and other carriage building works.

WHAT IT IS

The American Harness and Saddlery Directory **The 1914 Edition**

An extra painstaking revision of the names (and other information as below) constituting the Retail Harness Trade, has been completed for this year's issue of the Directory, and we think the work is so important and worthy that the

1914 Price Is \$5 Per Copy

and it is very moderate for what is offered in a work that is

Indispensable for Reference

for copying of addresses, and for all purposes usual in a directory.

Just a Sketch of Its Contents

The list of the **WHOLESALE** and **JOBGING TRADE** is so arranged as to make it convenient to separate the association members from those not so recognized.

The **RETAIL HARNESS MAKERS** of the United States and Canada comprise the principal part of the Directory, arranged by State, Town and County, and in the large cities, the street and number is given. Those rating (approximately) over \$1,000 are marked.

A list of **HARNESS DEALERS** as distinguished from retail harness manufacturers, is also given. The value of this list to those who solicit the vehicle, implement, hardware and department stores will be readily appreciated.

A list is also published of Export Commission Merchants, giving the class of merchandise they handle.

PUBLISHED BY

THE TRADE NEWS PUBLISHING COMPANY

PUBLISHERS OF "HARNESS"

24-26 MURRAY ST., NEW YORK

BUSY BUYERS BRIEFS

JOHN C. MEYER & Co.
THE
LOWELL THREAD
MILLS
MANUFACTURERS OF
HIGH GRADE SEWING THREADS AND SPOOL SILKS
BEST IN THE WORLD
 LOWELL, MASS. U.S.A.

Baltimore Hub-Wheel & Mfg. Company
 Manufacturers of
Wheels AUTO MOTOR CAR CARRIAGE WAGON
Also SPOKES and RIMS
 Factory: Harford Ave. and B. & O. R. R.
 BALTIMORE MD.

CHARLES L. DOWLER
 CARRIAGE AND WAGON HARDWARE
 108 North Third St., Philadelphia, Pa.
CUSHION MANUFACTURER
 Pure Stearic Acid Candles. Wheel Stock. Snow Flake Axle Grease.

MULHOLLAND BUGGY SPRING
 Reduces weight of springs one-half. Made in one size only but will fit bodies of all widths.
 Write for further particulars and prices.
THE MULHOLLAND CO. DUNKIRK, N. Y.

White's Brazing Sleeves
 For applying Rubber Tires
 Send for Samples.
WHITE-QUEHL MFG. CO.
 431 E. Pearl St.
 CINCINNATI, OHIO

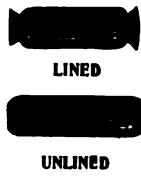

AUTOMOBILE Bodies AND CARRIAGES IN THE WHITE
 Estimates Furnished on Special Designs
MILLER BROTHERS
 Amesbury, Mass.

E. SCOTT PAYNE CO.
 Carriage and Automobile **HARDWARE**
 Horse - Shoers' Supplies
 362-364 North Gay St., Baltimore, Md.

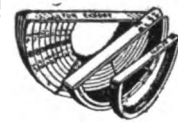

One of the oldest and largest Rim Plants in the world.
BENT RIMS
 For Carriage and Wagon Wheels
 For Automobile Wheels
 We make prompt deliveries in HICKORY and OAK RIMS.
THE J. M. SKINNER BENDING CO.
 Toledo, Ohio

Carriage Mechanics

Desiring to improve their present Condition should attend the

TECHNICAL SCHOOL

FOR

Carriage Draftsmen and Mechanics

SUPPORTED BY THE

Carriage Builders' National Ass'n

The object of the School is to teach men to design vehicles and make working drawings, and to otherwise facilitate their work in the shop. Only those men employed in carriage or automobile building or their accessory trades are admitted to its privileges.

The classes are conducted in three divisions, viz.: Corresponding, Day, and Evening. The former is open during the entire year, while the day and evening classes are in session only from October 1 to April 1.

The tuition is moderate.

For prospectus and full particulars, write to the instructor,
ANDREW F. JOHNSON,
 20 West Forty-fourth St.,
 NEW YORK CITY

Cargill Service

has brought to the Cargill Company more Vehicle Catalogues than are made by any other printing house in America.

Cargill Quality is bringing The Best Automobile Catalogues to our plant for Complete production—watch for our imprint in the Season's best books.

THE CARGILL COMPANY

DESIGNERS
 ENGRAVERS



PRINTERS
 & BINDERS

Grand Rapids, Michigan

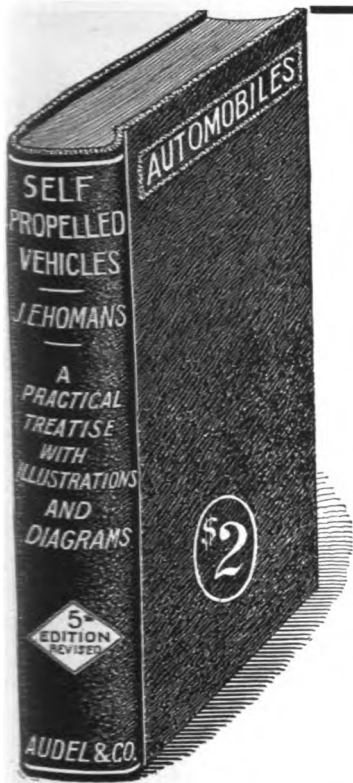

"Self-Propelled Vehicles"

Fifth Edition, Revised.

A practical treatise on the theory, construction, operation, care and management of all kinds of Automobiles.

By

JAMES E. HOMANS, A.M.

Contains 608 pages and upwards of 500 illustrations and diagrams, giving the essential details of construction and many important points on the successful operation of the various types of motor carriages driven by steam, gasoline and electricity.

This work is now the accepted standard, explaining the principles of construction and operation in a clear and helpful way. This book will be sent postpaid to any address in the United States, Mexico or Canada upon receipt of \$2.00.

Address

Trade News Publishing Co.

24 Murray Street, New York

Lawson's Sunken Panel, Twin Metal Buggy Seats



The Strongest—Neatest on the Market
Made in six sizes of 20 gauge automobile sheet metal. The Lawson seats are edged and bumped together by heavy presses.

We Use No Solder

Our seats were never known to come apart or rumble.

Write for Prices

The F. H. Lawson Co.

(Established 1816)

Cincinnati - - - Ohio

1855—Standard for 59 Years—1914

Jones Wheels

"Best on Earth"

The Name of Jones as Applied to Wheels Means the
First, Last and All-the-Time Word in Wheels
"Kantsamore"

Buyers of vehicles should say, "Give me wheels made by

Phineas Jones & Co.

NEWARK NEW JERSEY U. S. A.

THE FAIRFIELD RUBBER COMPANY

Manufacturers of

Carriage Cloth, Imitation Leather,
Automobile Cloths, etc.

FAIRFIELD, CONNECTICUT

The WEST Hydraulic Tire Setter

WILL CUT DOWN EXPENSE

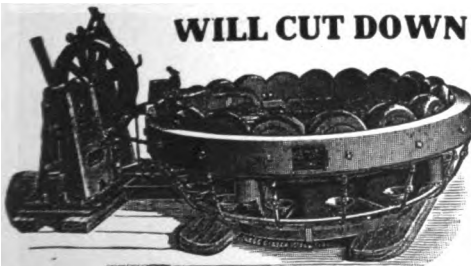

Tires set cold in one minute. This machine saves time—does the work better and quicker, does a way with burned streaks. Only necessary to measure one wheel in a lot. Does not char the rim, and thus make the tire loosen prematurely.

Saves resandpapering of wheels. This machine is now increasing the profits of many manufacturers. Send for catalog and read about it.

WEST TIRE SETTER CO., ROCHESTER, NEW YORK

KEYSTONE BLACK FILLER

MAKES A PERFECT

ROUGHSTUFF

For Automobile Bodies and Parts

It fills the pores of Metal and Wood perfectly. Sandpapers easily and produces a fine smooth surface that DOES NOT CRACK, SCALE NOR PEEL.

POMEROY & FISCHER, New York
Selling Agents to Vehicle Trade

KEYSTONE PAINT AND FILLER CO., Muncy, Pa.

BENT RIMS

Hickory Second Growth and Forest Hickory
All Grades

OAK—STAR BRAND

SPOKES

Second Growth Hickory—Finished and Club Head

SUITABLE FOR ALL VEHICLES, INCLUDING AUTOMOBILES

VIRGINIA AND NORTH CAROLINA WHEEL CO.

8 Bridge Street, New York City

RICHMOND, VIRGINIA

"BLACK VELVET" CUSHION SPRINGS

Manufactured Only by the

NATIONAL SPRING AND WIRE COMPANY

ALBION, MICH. WINDSOR, ONT.

THE SPRING OF QUALITY.



SPRING or SOFT EDGE CUSHION FRAME

For Buggies or Other Vehicles. Built of the Highest
Grade of Steel Wire.

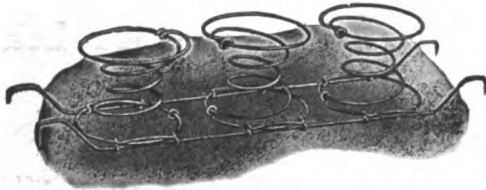

STRIP FOR WOOD OR BOX FRAME

WILLEY'S COLORS

The RECOGNIZED STANDARD



C. A. WILLEY CO.

COLOR GRINDERS

and Manufacturers of Specialties in

CARRIAGE, AUTOMOBILE AND CAR

PAINTS

COLORS, VARNISHES, ETC.

HUNTER'S POINT, NEW YORK CITY

Skewed Shaft Couplings

Regular or Oval Patterns
For High Arched Axles

Furnished in rights and lefts for any height of arch. Oval Axle
Clips $\frac{5}{8}$ or $\frac{3}{4}$ width to match Oval Couplings. Bolts, Clips,
Couplings, Carriage Hardware and Special Forgings

Catalogue "H" and Prices on Application

COLUMBUS BOLT WORKS, Columbus, O.

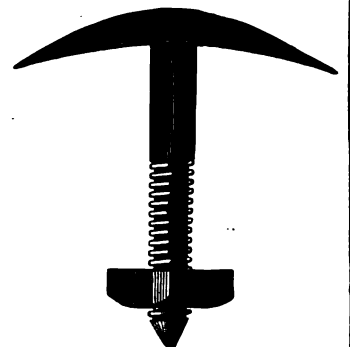
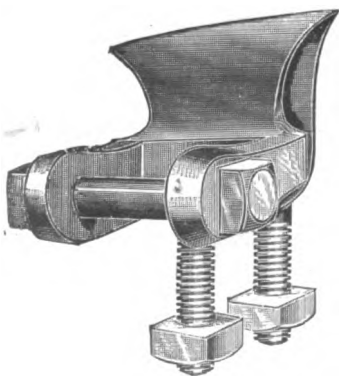

The Hub



C.B.N.A.
CONVENTION

ATLANTIC CITY
NEW JERSEY
SEPT. 28 TO OCT 2 1914

TRADE NEWS PUBLISHING CO
24 & 26 MURRAY ST NEW YORK

To one and all:

PHINEAS JONES & CO.

Wheel Makers

Regret that they will not be represented at our convention, the C. B. N. A., this year at Atlantic City, circumstances preventing.

We send our best regards to all in attendance, and wish them a very pleasant time at our honorable convention.

PHINEAS JONES & CO.

Newark, N. J.

Henry Phineas Jones, President.

HOTEL CUMBERLAND

NEW YORK

BROADWAY AT 54TH STREET

Near 50th St. Subway Station and 53d St. Elevated.

"Broadway" cars from Grand Central Depot pass the door, also 7th Avenue cars from Pennsylvania Station.

New and Fireproof

Best Hotel Accommodations in New York at Reasonable Rates.

\$2.50 with bath and up

European Plan

All Hardwood Floors and Oriental Rugs

Ten minutes' walk to 40 Theatres

Excellent Restaurant
Prices moderate

Send for Booklet



HARRY P. STIMSON, Formerly with Hotel Imperial

Only New York Hotel window-screened throughout

JOHN W. MASURY & SON

Originators of

Superfine Coach and Automobile Colors

Acknowledged the Standard for Fifty Years

AND MANUFACTURERS OF

Fine Carriage and Automobile Varnishes

New York,

Chicago,

Minneapolis,

Kansas City

SHERWIN-WILLIAMS
VEHICLE FINISHES

A PRODUCT FOR EVERY PURPOSE, PRODUCING DISTINCTIVE RESULTS

S-W METAL PRIMERS S-W BODY AND GEAR UNDERCOATINGS
S-W Q. D. COLORS S-W COLOR VARNISHES
S-W FINISHING VARNISHES

EFFICIENT IN QUALITY AND UNIFORMITY

THE SHERWIN-WILLIAMS Co.

CLEVELAND CHICAGO NEWARK MONTREAL LONDON, ENG.

WILCOX **F**INE
FINISHED
FORGED

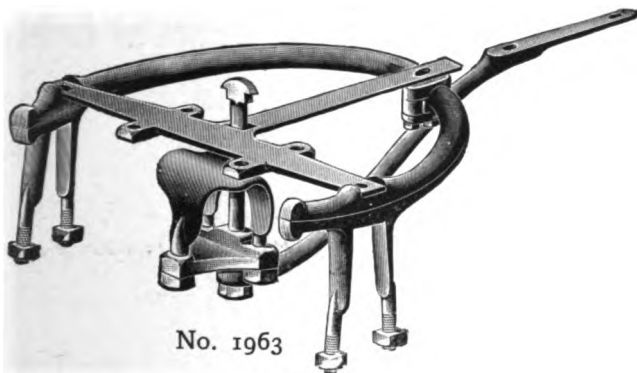

**Carriage Hardware
and Gear Irons**

Write us for Catalogue No. 11B

The D. Wilcox Mfg. Co.

**MECHANICSBURG,
CUMB. CO., PA.**

“TRIUNE” COLOR VARNISH

**SOLVES the PROBLEM of embodying THREE
essential qualities in ONE product:**

1st--Color.

2d--Power to cover in ONE COAT.

**3d--STRAIGHT VARNISH working proper-
ties and qualities.**

Our trade name **“Triune”** (three in one) aptly suggests the three essential characteristics that serve to distinguish the F. O. Pierce Company's **Color Varnish** from Enamel and Gloss paints, and from other products made to imitate its unique and valuable combined qualities.

“TRIUNE” COLOR VARNISH is strictly a Varnish Product possessing color with the power to Cover in one Coat. It works as freely as straight varnish and will “flow,” “level,” “rub,” “moss” and exhibit in general full durable qualities and working properties.

Color folder, showing 15 popular shades, upon application.

Sole Manufacturers

F. O. Pierce Company, New York City

12 West Broadway

LIMOUSINE STEEL SEAT

READY FOR THE SEASON OF 1915

NOT A WELD, JOINT OR SEAM—ONE PIECE; ALL STEEL

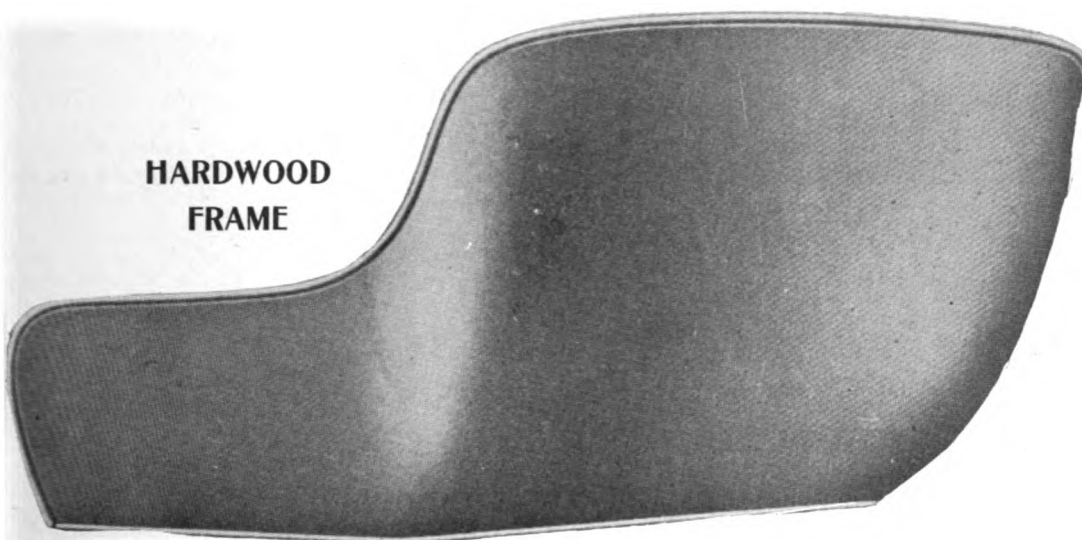

HARDWOOD
FRAME

SEND
FOR
OUR
CATALOGUE

DESIGNED AND MANUFACTURED EXCLUSIVELY BY US

METAL PIANO BODIES

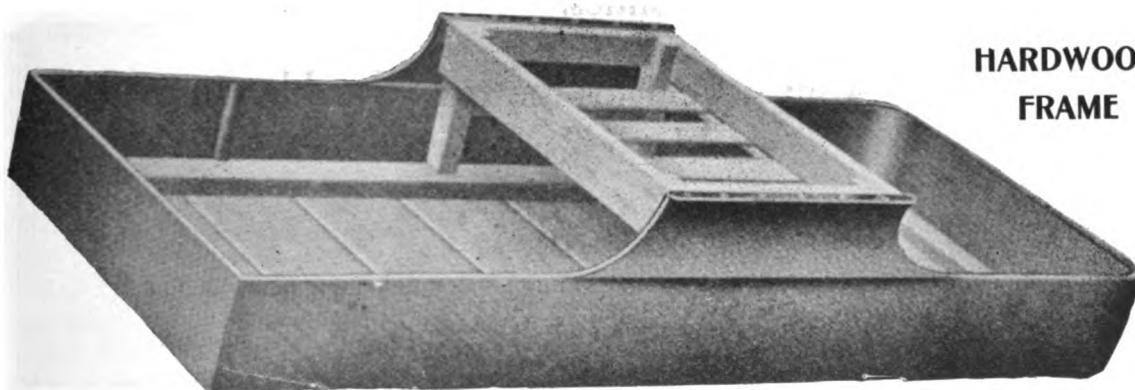

MADE IN
6½ OR 7 IN.
PANELS.

AT A
PRICE

HARDWOOD
FRAME

TAKE THIS OPPORTUNITY TO INQUIRE

CENTRAL MANUFACTURING CO. CONNERSVILLE, IND.

Quality
Is
Economy

*You are Safe both ways
in using our modern
Palest Durable Body*

For many years, Palest Durable Body was known as the *most durable* Carriage Varnish.

It was not the easiest-working or the finest-flowing.

There were varnishes, famous for easy working and fine flowing—but sadly lacking in durability.

Our modern P. D. B. is as *easy under the brush*, and it *flows as perfectly* as any varnish that is most famous for these qualities.

Also: it remains the most durable Carriage Varnish.

The Varnish
That Lasts
Longest

Murphy Varnish Company

FRANKLIN MURPHY, President

Associated with Dougall Varnish Company, Limited,
Montreal, Canada

NEWARK
AND
CHICAGO

The Hub

Copyright, 1914, by the Trade News Publishing Co., of New York

Entered in the New York Post Office as Second-class Matter

Vol. LVI

SEPTEMBER, 1914

No. 6

THE TRADE NEWS PUBLISHING CO. OF N. Y. Publishers of THE HUB

J. H. WRIGHT, President G. A. TANNER, Secretary and Treasurer
24-26 MURRAY STREET, NEW YORK

Other Publications of Trade News Publishing Co.:

HARNESS (monthly).....per year, \$1.00
AMERICAN HARNESS AND SADDLERY
DIRECTORY (annual).....per copy, \$5.00

THE HUB is published monthly in the interest of employers and workmen connected with the manufacture of Carriages, Wagons, Sleighs, Automobiles and the Accessory trades, and also in the interest of Dealers.

Subscription price for the United States, Mexico, Cuba, Porto Rico, Guam the Philippines, and the Hawaiian Islands, \$3.00, Canada, \$2.50, payable strictly in advance. Single copies, 25 cents. Remittances at risk of subscriber, unless by registered letter, or by draft, check, express or post-office order, payable to the order of THE TRADE NEWS PUBLISHING CO.

For advertising rates, apply to the Publishers. Advertisements must be acceptable in every respect. Copy for new advertisements must be received by the 25th of the preceding month, and requests to alter or discontinue advertisements must be received before the 12th day of the preceding month to insure attention in the following number. All communications must be accompanied by the full name and address of writer.

FOREIGN REPRESENTATIVES:

FRANCE—L. Dupont, publisher of *Le Guide des Carrossiers*, 78 Rue Boissiere, Paris. Subscription price, 15 francs, postpaid.

GERMANY—Gustave Miesen, Bohn a Rh. Subscription price, 12 marks, postpaid.

ENGLAND—Thomas Mattison, "Floriana," Hillside avenue, Bitterne Park Southampton. Subscription price, 12 shillings, postpaid.

Entered in the New York Post Office as Second-class Matter

The War—The Automobile

One of the most interesting developments of the war is the use made of the motor car.

It is not too much to say that it has put a new wrinkle on the front of grim-visaged war. It certainly has changed the status of the horse most peculiarly.

We hear of officers using motor cars for cavorting over the roads on business, and for every other purpose, even to supplementing the railroad transport the gas engined car has occupied the very center of activity.

Of course, in the circumstances of the present war the motors have the best of roads to negotiate. If they had to plow through "gumbo," as would be the case on this continent, they would be in the discard, and the mule would maintain his present ascendancy. But long years and enlightened public opinion has made the roads of Europe what roads should be everywhere, hence we see a use made of the motor car that is absolutely novel.

And the numbers employed are said to mount into tens of thousands in all. All means of transportation, for all kinds of service appear to be in use. Even the extremely heavy siege artillery, that would be almost impossible to negotiate with horses, is hooked up to our

"caterpillar" design of tractor (originated in this country), and trundled over the country at the rate of four miles per hour. These guns are so heavy that the wheels of the gun carriages are said to sink into the asphalt two or three inches, yet our creeping caterpillar yanks them over the country in a way impossible to horses.

Fact is, the horse as an animal to help along the impedimenta of an army has been completely put to one side. His use as a cavalry mount is still prime, but even here we have armored scouting automobiles, although the horse is still supreme.

In the way of government owned or subsidized cars and trucks, all the nations in the mix-up were better supplied than Britain, but the English just laid their hands on everything that was gas-propelled, and as a result it has a conglomerate of types that must remind the beholder of Falstaff's army; but the best technical experience is liable to be the outcome, as everything will be tried out to destruction, and many important facts will be noted, probably.

The English grabbed their transportation so rapidly and suddenly that no time was wasted in armyizing them, so to speak. It must look queer to see a "lorry" full of wounded conveyed to the rear under the sign Beecham's pills, as if that is what had caused the damage, but "Richard's General Providers" would be in accord with the fitness of things taking bacon and bread to the front.

When all is over, a chapter on the automobile in war will be far from the least interesting to read.

Hurrah for the trade press! We are beginning to notice the outcroppings of the enterprise of the country's business journals. We notice "special representative of the ——— with the allied armies."

In view of the news that the aforesaid A. A. do not tolerate any kind or description of the genus scrivener with the armies, we must continue to say it takes our trade press to show enterprise! The example comes from the motor press, of course, where the daily pabulum is—ahem! extravagant statement.

Very timely literature is a manufacturer's report of business and its methods in South American countries. It is plain and understandable and very well worth the attention of any desiring such trade openings, as it supplies the details overlooked, often, about banking, etc., that are essential. The Bureau of Foreign and Domestic Commerce has the information in the form of a bulletin.

"Acknowledged the standard." This is a phrase not at all uncommon. It is generally used in an advertising way. If it were believed at all it would be a very powerful statement, but when it is known to be not credited in the least it becomes a question if it is not as weak as misleading. Is that good advertising?

The war has bothered the paint grinders somewhat. Some of the imported pigments or dyes are lacking, and they are not to be had in the open market. Happy the paint maker who has a surplus stock. The reds are very shy, blushing so.

Up to July first of this year the count of automobiles, as registered, totals 1,548,350, which may be taken as the motor car census. There are, therefore, in all, as many motor cars, almost, as there are buggies produced in almost any one year.

There are many designers of vehicles who have thought a long while on new designs, but have never got anywhere because they did not think along productive lines.

The mineral production of only California is valued at over 100 million dollars.

HOW IT LOOKS TO AN AUSTRALIAN BUILDER

At the coachbuilders' convention in Auckland, a Mr. Muchmore, representing the country coach builder, was telling of his business experience since the advent of the motor car. We think his views will find interest with readers. He said:

Some years ago, I think in 1904, a customer asked me to sell his gig, as he was going to do away with horses and get a motor car. At the same time he advised me to go in for car work. That gentleman got his car, which was the first in Timaru, and people took a great interest in it. After seeing it I also thought it would make a great difference in country coach building, but, as luck would have it, that gentleman's car got entangle with some veranda posts, and it came to me for the repairs of the carriage part of the car, and we got more out of the repairs of that car in six months than we would have had out of his gig in as many years. I then said we must look after the car repairs, and I think they will not do us much harm if we get that part of the work. In those days the amount on our books, and for a few years after, for car work was very small; but today the lion's share of my firm's turnover for the year is for car work, which shows the trend of the trade in country districts. Some years ago the best of our customers were gentlemen of means, who kept a large stock of vehicles for pleasure. Today, in a district like Timaru, a gentleman's carriage and pair are never seen. What is the effect on the country coach builder? If he can keep that customer and do all the coach building repairs required on the cars he will be probably receiving a larger turnover from that customer, and also doing work from which he would receive a larger profit. Country coach builders at the start of motor car work, and probably at the present time, are under a disadvantage as against the towns for car work. Cars are so easily taken to towns that a good deal of work goes to the towns which should be done in the country. The customer seems to think that we country builders cannot do the work as well as those in the town.

An old customer of ours once said to me, "Can your painter paint my car and make a good job of it?" I replied, "Yes." He replied, "You cannot make as good a job as they can in Christchurch; they have better men up there." I asked him

whether he thought the Christchurch gentleman was any better than he was. Of course he did not. I told him that was exactly the position we took up with regard to our men. This argument was enough for him to leave his car at our works, and he is still a good customer of ours. My advice to country coach builders is not to start by doing cheap work at cheap prices. Most car owners require a good job, and we should make them pay for one. Cars are a luxury. Those who own them have the money, and our motto should be, "Do a good job, and charge a good price." If we do that, the pleasure car will mean the advancement of our country coach builders' turnover and a better per cent. of profit.

The effect of the pleasure car on the carriage building part of the business has been disastrous. I do not know of any builder in this district who has built anything in the way of a decent carriage for some years past. If anything in that line is required they can always be procured second hand very cheap. The time is fast approaching when most of the pleasure driving will be done by motor power, and we must keep our eyes on that branch of the business, or we shall be left behind. I say we should force the government to increase the tariff on cars imported complete to a prohibitive price, and thus compel the importer to have all the carriage building done in this dominion. The pleasure car would then be a boon to the country coach builder, as I think he would be able to get his fair share of the work. The result will then be for our good, providing that we do not do what has been done in the carriage building in a good many country districts—each trying to beat the other for a job and doing the work for cost.

BEST OF REASONS GIVEN

In reply to our request for information, a prominent Iowa buggy-building concern gives the following quoted opinion of storm buggies:

"Wish to say that this company does not build a storm buggy and never has built a storm buggy, and does not expect to build storm buggies in the future. The reason for this is that the people who are building storm buggies seem to have lost all idea of profits, and the vehicle has been sold at such prices that there is no margin in it."

Still another concern in Columbus writes:

"Would say that we propose to discontinue the manufacture of storm buggies. We do not believe that the demand will increase—on the other hand, it appears to us that it will fall off. Further, we do not believe that there is any profit to be made at the present prices which manufacturers are getting for them, and it is our frank opinion that one of the greatest evils of the carriage business today is the terrible greed for volume shown by so many manufacturers, with no regard for net profit."

GUSTAV SCHAEFER WAGON CO. ENLARGES PLANT

The Gustav Schaefer Wagon Co., 4170-4180 Lorain avenue, Cleveland, O., is building a large addition to its factory, which will be four stories in height, besides a basement. The floors will be strong and heavy, and the ceilings extra high. In the lower floor, which is intended for smith work, overhead traveling cranes will be installed for handling heavy pieces. The structure will be fireproof throughout and has been designed with as many steel sash windows as possible in order to get plenty of daylight.

The entire plant will be heated by steam and lighted by electricity, and a 15,000-pound elevator, with a 26 x 10-foot platform, will furnish efficient means for handling the largest motor trucks now in use. The company has specialized for 34 years in heavy trucks and moving vans, and during the past five years has had a great demand for heavy motor truck bodies.

The Builder's Own Choice of His Best Style

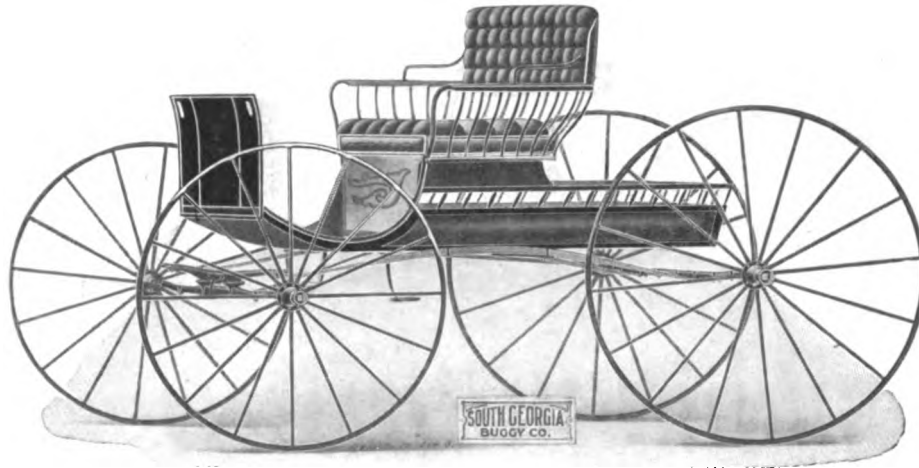

SPINDLE SEAT BUGGY
Built by
SOUTH GEORGIA BUGGY CO.
Valdosta, Ga.



AUTO-SEAT BUGGY
Built by
PAGE BROS. BUGGY CO.
Marshall, Mich.

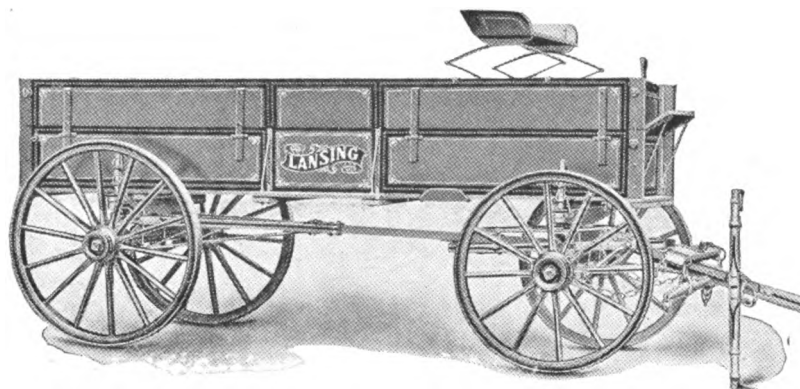

FARM WAGON
Built by
LANSING WAGON CO.
Lansing, Mich.

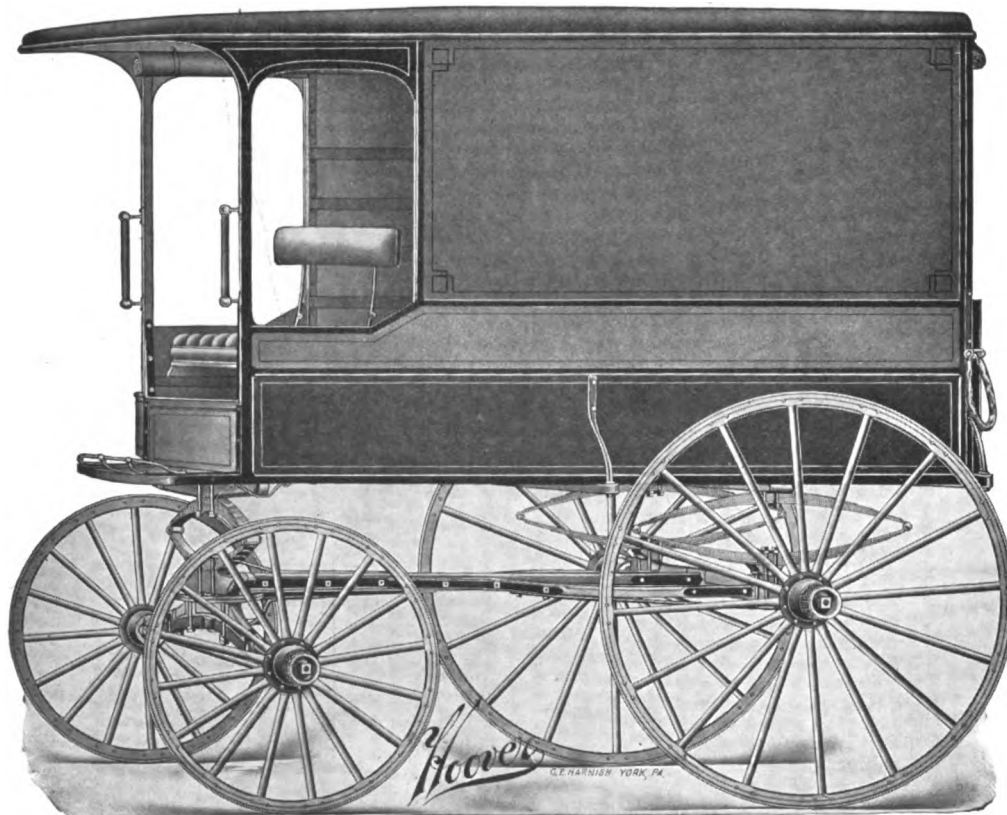

NEW YORK STANDARD WAGON
Built by
HOOVER WAGON COMPANY
York, Pa.



CUT-UNDER RUNABOUT
Built by **STAVER CARRIAGE CO., Chicago, Ill.**

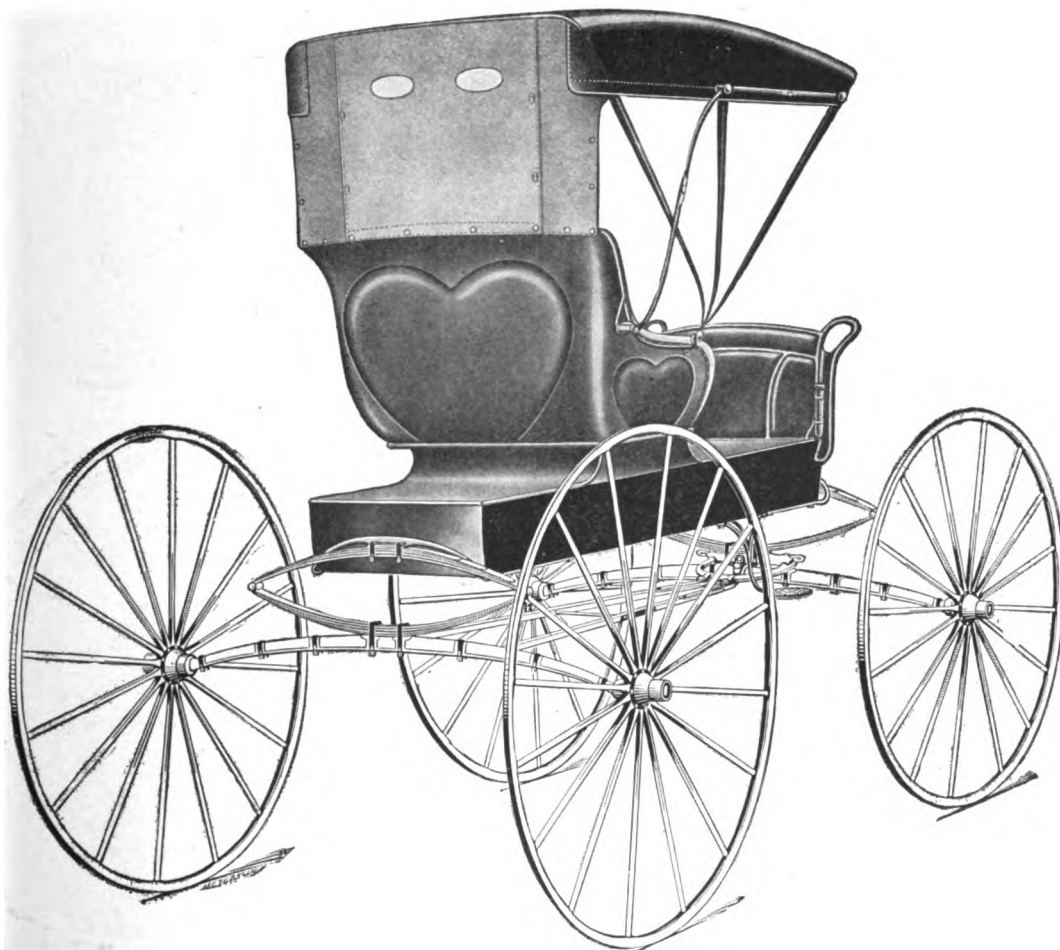

FULL WROUGHT GEAR BUGGY
Built by **PARRY MANUFACTURING CO., Indianapolis, Ind.**

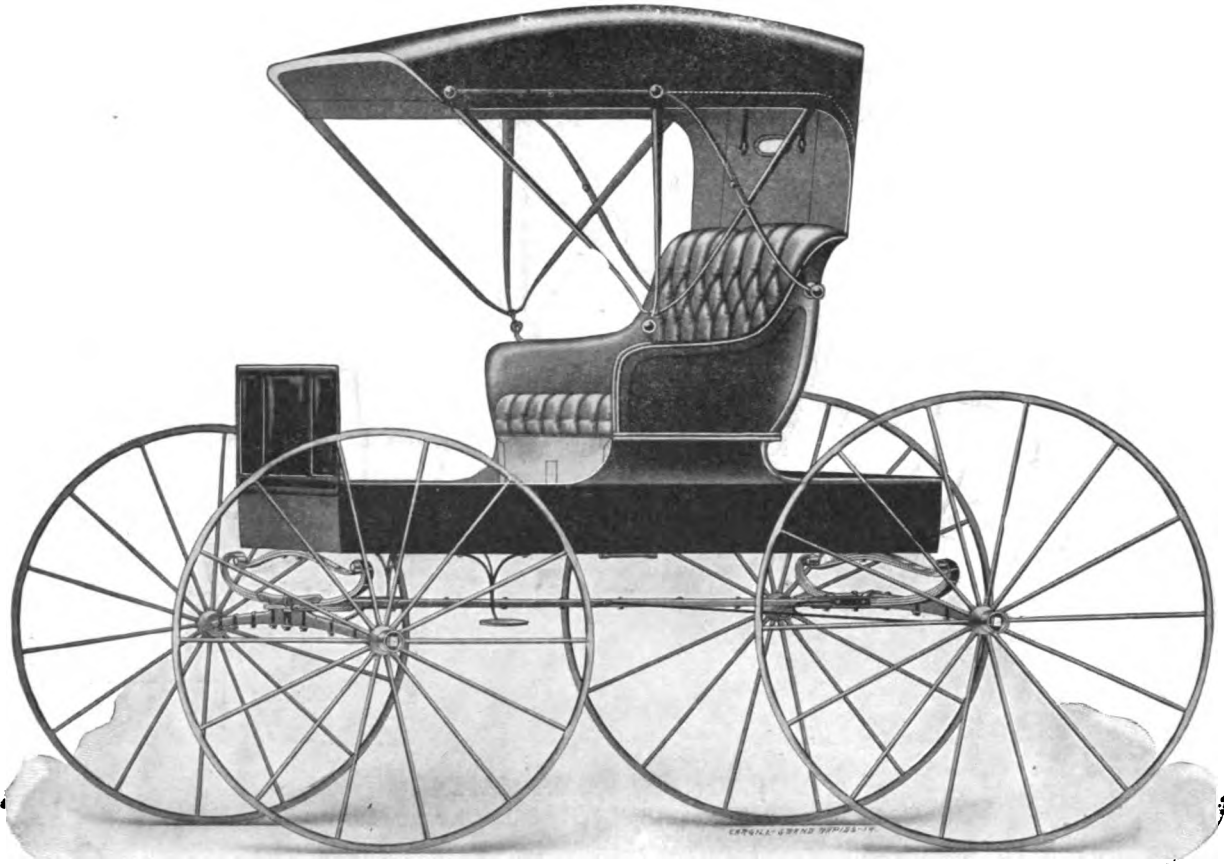

BUGGY HUNG ON CUMMINGS PATENT GEAR
 Built by ECKHART CARRIAGE CO., Auburn, Ind.

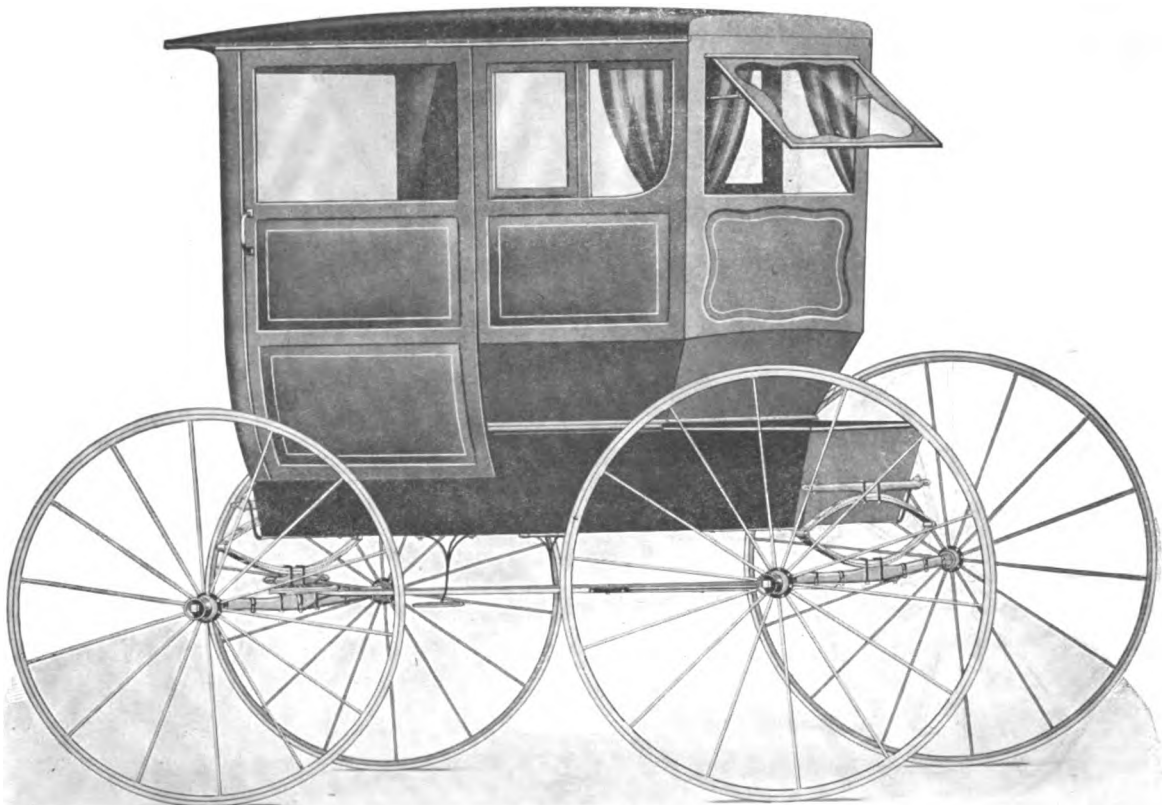

THE AMES SEASON'S LEADER
 Built by F. A. AMES CO., Owensboro, Ky.

The C. B. N. A. Program

FIRST DAY

Tuesday, September 29, at 10 a. m.

It is the desire of the president and the association that the proceedings shall open promptly at the hour named.

And to this session all the ladies visiting the convention are most cordially invited.

The meeting will be called to order by the president, Mr. William H. Roninger, St. Louis, Mo.

Address of welcome, by an official of Atlantic City.

Response on behalf of the association by Homer McDaniel, Cleveland, O.



President W. H. Roninger

Opening address by the president, William H. Roninger, St. Louis, Mo.

Address by Adrian D. Joyce, Cleveland, O., on "Modern Business Tendencies."

Address by C. W. Shipley, Cincinnati, O.

Address by E. M. Galbraith, Cincinnati, O.

Nomination of president for the ensuing year.

Appointment of a Committee on Resolutions.

Appointment of a Committee to Recommend Officers for the ensuing year.

Appointment of a Committee on the Exhibition.

Appointment of an Obituary Committee.

Adjournment.

On this Tuesday evening, September 29, the reception and entertainment to the members and their families will be held at the Marlborough-Blenheim. All members and their families attending the convention are invited to be present. Tickets for this occasion will be furnished free to members and their families.

SECOND DAY

Wednesday, September 30, 10 a. m.

Meeting will be called to order by the president, Wm. H. Roninger.

Address by H. Collier Smith, Detroit, Mich., on "Sheet Metal Work as Applied to the Horse-drawn Vehicle."

Address by Louis H. Rogge, Dayton, O., on "Vehicle Advertising."

Address by Wm. H. McCurdy, Evansville, Ind.

Address by H. A. White, High Point, N. C.



Secretary Henry C. McLear

Report of the executive committee, Charles A. Lancaster, South Bend, Ind., chairman.

Report of the secretary and treasurer.

Report of the Committee to Recommend Officers for the ensuing year.

Election of president.

Adjournment.

THIRD DAY

Thursday, October 1, at 10 a. m.

Meeting will be called to order by the president, Wm. H. Roninger.

Report of the Committee on Statistics, O. B. Bannister, Muncie, Ind., chairman.

Report of the Committee on Cost Schedules, W. A. Sayers, Cincinnati, O., chairman.

Report of the Trustees of the Technical School, Daniel T. Wilson, New York, chairman.

Report of the Committee on Freight and Classification, Theo. Luth, Cincinnati, O., chairman.

Report of Committee on Abuses in the Carriage and Accessory Trades, Perrin P. Hunter, Cincinnati, O., chairman.

Report of the Committees on New Members, Wm. H. McCurdy, Evansville, Ind., chairman central division; C. O. Wrenn, Norfolk, Va., chairman southern division; L. E. Hickok, Mechanicsburg, Pa., chairman, eastern division.

Report of the Committee on the Press, G. A. Tanner, New York, chairman.

Consideration of the report of the Executive Committee.

Unfinished business.

New business.

Election of officers.

Report of the Committee on Resolutions.

Report of the Committee on Exhibition.

Report of the Obituary Committee.

Selection of the place for the next convention.

Adjournment.

Annual Banquet, Marlborough-Blenheim, Thursday October 1, at 7 p. m.

Tickets for the banquet can be obtained from the secretary at Atlantic City.

At the annual convention, held in New York, October 9, 1907, a resolution was passed "that the secretary be required to charge for all extra tickets the cost of the same per plate." As this banquet will cost slightly over \$7 per plate, the extra tickets will be \$7 per ticket.

This does not concern the members' own tickets, as they are all entitled to one ticket free. Only applies to the extra tickets any one may wish to have. Please note this so there will be no misunderstanding.

For the accommodation of the members of the association, the secretary will be at the exhibition hall on the afternoons of Tuesday, Wednesday and Thursday, September 29, 30 and October 1, from 2 until 5 o'clock, for the reception of new members, giving out banquet tickets, and such other business as may be required of him. The members are earnestly requested to procure their banquet tickets as early as possible, so that we can tell how many will be present at the dinner.

To prevent mistakes and misunderstandings, the executive committee has adopted the following rule: Members of the association who desire their representatives to use their banquet tickets must give an order for the same in writing to the secretary.

FRANCE'S AUTOMOBILE INDUSTRY UNDER ARMY CONTROL

Inquiries in the various automobile factories around Paris show that the production of touring cars is absolutely nil. In many cases important orders are in hand and a sufficient staff has been left to put work through if only permission could be obtained to export, reports the special representative in France of The Automobile.

Efforts are now being made to obtain from the Minister of War a repeal of the order forbidding the exportation of automobiles and automobile parts, at any rate so far as regards allied countries. It is believed that the reasonableness of this request will be seen and that within a very short time it will be possible to send cars to England, and from there to other parts of the world.

A few of the factories have been militarized. In this case the original staffs have been retained, but the men are under military rule and work under the control of army officers for the army. Among these are Gnome, making aeroplane motors; Anzani, on the same class of work, and the aeroplane motor department of the Renault factory. The Blum-Latil factory, in which numbers of four-wheel-drive tractors are produced, is under military rule.

De Dion Bouton is under military law, with 1,000 men working on trucks, automobile cannon, and also on special work for the military arsenal at Puteaux.

Motobloc at Bordeaux is militarized.

Berliet is under military rule with 300 men working on trucks. The factory will deliver 180 trucks by the end of August and 250 by the end of September.

The Mors factory was militarized for a short time, but is no longer working for the army.

In addition to those firms directly responsible to the army authorities, several are working exclusively on army orders. Thus Saurer has been able to maintain a staff of 200 out of 800, which will be increased shortly to 400 or 450, all the men working on trucks or spare parts. This firm has 800 trucks on the fighting line.

Panhard is working almost exclusively for the army and navy making trucks and war supplies.

Renault has stopped the production of touring cars and is building trucks for the war department.

Peugeot has been able to keep all three factories open with very reduced staffs, the work done being for the army. Robert Peugeot is serving as a lieutenant in an artillery regiment at the front.

The Mercedes repair shops near Paris have been taken over by the war department and are used as an extension to the military arsenal at Puteaux. The stock of finished cars at the firm's showrooms in Paris has been requisitioned for army service.

Bayard-Clement is working with 150 instead of 1,500 men, all of them engaged on airships and trucks.

Delaunay-Belleville is doing nothing but military work, this including material for the artillery service. Instead of cars bombs are being manufactured in the Alda factory.

Alcyon has closed down all but its motorcycle department. Delahaye has had its commercial vehicle section militarized.

All other factories appear to be closed entirely or are merely keeping the spare parts department going. The Unic people have kept on 200 men, who are producing for stock, the company having a sufficient number of orders in hand to expect a quick release when peace is declared.

The Darracq big erecting shop has been turned over to the war department and is now used for making cartridges. Only the spare parts department is running. Most of the foremen have been returned from the war, the authorities having more men than they need, but workmen and supplies are not obtainable.

Charron, Vinot, Dietrich, Delage, Hispano-Suiza, are all closed.

Brasier is working with one-quarter of the original staff, but having received army orders will take on more men shortly.

CENSUS OF AMERICAN (?) LABOR IN FORDTOWN

Poles	2,677
Russians	2,016
Italians	690
Roumanians	388
Syrians	330
Hungarians	269
Servians	210
Turks	81
Lithuanians	73
Crotians	55

Why shouldn't the car make a noise as of many tongues?

THE TRIUNE SYSTEM

The announcement of the F. O. Pierce Co., of New York City, in this number is very interesting. There have been such real advances in the manipulation of varnish and color that the painter ought to be a happy artisan.

Systems like the Triune save such time and do what is to be done so much better than it has been done before. It is all most interesting, and to the painter, important.

ELECTRIC VEHICLE CONVENTION

The fifth annual convention of the Electric Vehicle Association will be held at the Hotel Bellevue-Stratford, Philadelphia, Monday, Tuesday and Wednesday, October 19-21. The following tentative program has been arranged for:

Electric Vehicle Association Reports

President's address, Frank W. Smith.
 Executive Secretary, A. Jackson Marshall.
 Committee on Membership and Formation of Sections, Joseph F. Becker.
 Committee on Operating Records, William P. Kennedy.
 Garage and Rates Committee, John F. Gilchrist.
 Insurance Committee, Day Baker.
 Papers Committee, S. G. Thompson.
 Committee on Legislation, P. D. Wagoner.
 Committee on Educational Courses, M. W. Alexander.
 Standardization Committee, E. R. Whitney.
 Traffic Committee, D. C. Fenner.
 Good Roads Committee, Col. E. W. M. Bailey.
 Central Station Co-operation Committee, W. W. Freeman.
 Parcels Post Delivery Committee, James H. McGraw.
 Railroad Development Committee, S. G. Thompson.
 Motion Picture Film Committee, W. C. Andrews.
 Constitution and By-Laws Revision Committee, Frank W. Frueauff.

The above reports of officers and special committees will be followed by the reports from the secretaries of the different sections of the country in which the work of the association is carried on.

Electric Vehicle Association Special Papers

"Progress of the Electric Vehicle," James H. McGraw.
 "Unusual Application of Electric Trucks," F. Nelson Carle.
 "The Motor Truck in Terminal Freight Handling," S. G. Thompson.
 "The Electric Vehicle in Parcel Post Service," W. P. Kennedy.
 "Educating the Public to the Field and Use of the Electric Vehicle," F. C. Henderschott.
 "Electric Fire Apparatus," Chief Walker, Philadelphia Fire Department.

Additional papers will be announced from time to time.

Further particulars are available upon application to the Executive Secretary, Electric Vehicle Association of America, 29 West Thirty-ninth street, New York City.

REVISED CONSTITUTION OF S. A. E.

The amendments to the constitution presented, discussed and amended at the meetings of the society held in January and June were almost unanimously carried in the written ballot of the members, the closure of voting on which was had in August.

The object of the society as set forth in paragraph 2 of the constitution is broadened specifically to include promoting standards and engineering practices connected with the design and construction of automobiles, all forms of self-propelled or mechanically-propelled mediums for the transportation of passengers or freight, and internal combustion prime movers. This, as is known, is declaratory of the procedure of the society work in recent years. Under the old constitution the standards and recommended practice work was described in a general way only, the appointment of professional committees by the council and the acceptance of reports recommended by such committees by the society being authorized.

Under the new constitution reports of standards or professional committees or sub-committees or divisions thereof may be approved or adopted as the action of the society. The society may approve or adopt any standard, formula or engineering practice, but cannot approve any engineering or com-

mercial enterprise. It cannot consent to the use of its name or initials in any commercial work or business except to indicate conformity with its standards or recommended practices. The right to use the society emblem may not be granted to any but members, and then for society purposes only.

A department, bureau or office of a national, state, county or municipal government interested in the object of the society may now become a departmental member.

The qualifications for junior grade of membership have been changed, persons under 26 years of age and qualified to fill subordinate engineering positions in the automobile or allied industries, or regularly enrolled students or graduates of a technical school, now being eligible thereto. Formerly the qualifications for junior grade of membership were identical with those of member grade, except as to age. One effect of this was that upon reaching the age of 26 junior members went practically automatically into member grade. Under the present constitution a junior member will not be necessarily transferred to a different grade until reaching the age of 30.

As has been the practice for a long time in some engineering societies and like the method of societies similar to the S. A. E., the election of all applicants for membership is now by the council instead of by the voting members of the society.

EXHIBITORS AT TRI-STATE SHOW

The following are so far published as those who will exhibit at the Tri-State Show in Cincinnati, October 19-24:

American Carriage Co., Cincinnati, O.
 American Seeding Machine Co., Springfield, O.
 American Whip Co., Westfield, Mass.
 F. A. Ames Co., Owensboro, Ky.
 Anchor Buggy Co., Cincinnati, O.
 Banner Buggy Co., St. Louis, Mo.
 Bimel Buggy Co., Sidney, O.
 W. N. Broackway, Homer, N. Y.
 Brown Carriage Co., Cincinnati, O.
 Buob & Scheu, Cincinnati, O.
 Celina Mfg. Co., Celina, O.
 Colonial Carriage Co., Circleville, O.
 Connersville Buggy Co., Connersville, Ind.
 I. J. Cooper Rubber Co., Cincinnati, O.
 John Deere Plow Co., Indianapolis, Ind.
 Geo. Delker Buggy Co., Henderson, Ky.
 Delker Bros. Buggy Co., Henderson, Ky.
 Durant-Dort Carriage Co., Flint, Mich.
 Eagle Carriage Co., Cincinnati, O.
 Fitzgerald Saddlery Co., Maysville, Ky. (harness).
 Gerstenslager Co., Wooster, O.
 Graf-Morsbach Co., Cincinnati, O. (harness).
 T. T. Haydock Carriage Co., Cincinnati, O.
 Holcker Bros. Buggy Co., Crestline, O.
 Houghton Sulky Co., Marion, O.
 Indianapolis Saddlery Co., Indianapolis, Ind.
 James & Meyer Carriage Co., Lawrenceburg, Ind.
 Luth Carriage Co., Cincinnati, O.
 Mitchell Wagon Co., Racine, Wis.
 Mier Carriage & Buggy Co., Ligonier, Ind.
 Oliver Chilled Plow Works, South Bend, Ind.
 Parry Mfg. Co., Indianapolis, Ind.
 Peerless Buggy Co., Owensboro, Ky.
 Peters Buggy Co., Columbus, O.
 Phoenix Carriage Co., Cincinnati, O.
 Sayers & Scovill Co., Cincinnati, O.
 Schaefer Saddlery Co., Decatur, Ind.
 Sechler & Co., Cincinnati, O.
 Seidel Buggy Co., Richmond, Ind.
 J. H. & F. A. Sells Co., Columbus, O.
 Smith-Lockwood Mfg. Co., Omaha, Neb.
 Staver Carriage Co., Chicago, Ill.

THE WAR AND THE RUBBER TRADE IN THE UNITED STATES

Few industries are less directly connected with the scene of the great conflict now in progress in Europe than the rubber trade in the United States, and yet none has been more quickly or more widely affected. As an illustration of which fact the extraordinary performance of the crude rubber market in the early part of August might be cited. On the first day of August Upriver fine sold at 70 cents. On the seventh day of August it sold at \$1.20—an increase in six days of 71 per cent. On the same two dates plantation first latex sold at 55 cents and \$1.15—an advance in less than a week of 110 per cent. The rubber market has seen many fluctuations but at no time hitherto has there been any such rapid advance.

The crude rubber market was temporarily almost in a condition of panic and the feeling quickly communicated itself to the manufacturers, a number of whom, seeing the price of their necessary supplies going up with such unprecedented rapidity, announced a material advance in the price of manufactured goods. This was particularly true of the tire market.

The reasoning of the rubber men, both importers and manufacturers, was as follows: With only two or possibly three months' supplies of rubber at the factories; with not more than 300 or 400 tons in the hands of importers; with the sea swept clean of commerce; with the channels of receiving rubber effectually stopped and all the avenues of accustomed exchange closed and barred; with contracts to be filled and scant material to fill them with, of what avail was it that the accustomed supply of Amazon rubber was on the docks at Para ready for shipment and an ever increasing supply of plantation rubber waiting at Singapore to embark for American markets? In the state of the trade's mind at that time these southern and eastern supplies might as well have been in the moon. The situation looked desperate.

But after two weeks the feeling of alarm generally subsided. It was discovered that all commerce generally subsided. It was discovered that all commerce was not to be driven from the seas and that, barring German boats, the bottoms of other nations, and particularly of all neutral nations, would soon be able to ply their accustomed course. Congress rushed in at once to remove the restrictions that had for years so greatly fettered our merchant marine, and some shipping lines, including those to South America, promised an immediate addition to their number of ships; so that communication with Para appeared likely soon to resume its normal condition and, with the overwhelming advantage of the Allies on the seas, the likelihood of open water from Singapore to Liverpool and New York seemed, if not imminent, at least a probability of the early future.

In addition, it became more obvious with each day of fighting that it would be a long time before the European market could use more than a fraction of the rubber that had hitherto been delivered at its factories—which would mean all the greater supply for the manufacturers of the United States.

When these saner aspects of the situation began to appear prices receded, until during the latter part of August the quotations, both for Para and eastern rubber, had lost over two-thirds of their meteoric rise during the first week of the month. Many manufacturers also concluded that it would be unnecessary for them, at present at least, to demand an advance in their prices, and where their goods had been marked up during the first week of the month in several cases they were marked back again during the third week.

It cannot be said that the present situation is normal, for it is far from it; but it is sane and reasonable. The aspect of panic has been entirely eliminated.—India Rubber World.

R. P. Dowse, who was general sales representative of the Goodyear Tire & Rubber Co., Detroit, Mich., is now with the Kelly-Springfield Tire Co., Akron, O.

GEE! WHAT A DIFFERENCE IT WOULD SHOW

The Motor, of London, is showing its patriotism in a militant way. It desires to present undue war distress by keeping the trade at work. "Our scheme is perfectly simple," it writes. "We open the pages of The Motor for a list of all motor manufacturers, garages, agents, and all firms in any way connected with the motor trade who, for the time being, will undertake repair work in the undermentioned branches of the trade, and give with the bill an undertaking in writing to the effect that the charges made are the net costs plus 5 per cent. profit only.

"We feel a certain measure of confidence that a good section of the trade will make this sacrifice in their profits—without giving away trade secrets we may say that it will be a very considerable slice off the profits—and we have an equal hope that the motorists of the United Kingdom will rise to the occasion and avail themselves of so splendid an opportunity for getting work, which sooner or later will have to be done to their cars, carried through at the present time. They will thus be doing a good turn to the nation at large by limiting the ravages of the demon of unemployment, and they will also be doing themselves a good turn in saving a large amount of the cost of such repair work.

"It may be necessary in the near future to increase the margin of profit allowed to the trade, when (as we hope in the course of perhaps a few weeks) the general commerce of this country begins to assume a normal state of affairs. In the effort to make an immediate start before too many people are thrown out of employment, we have fixed the margin of profit at a very low figure. Obviously, therefore, when the general state of affairs improves, it will only be just to the trade to raise the percentage as and when we deem it advisable."

DEEDS, NOT WORDS

Quite a furore was created down at the store of the Deeds & Jordan Buggy Co. last week when, during the absence of President J. B. Deeds, a rank stranger came in and declared himself to be Mr. Deeds and wanted to take charge of things just as though they belonged to him. George Parrish came near throwing the stranger into the river, and would have done so, had a compromise not been reached.

The peculiar thing about it is that the fellow is still hanging around and continues to insist that he's Deeds. This claim is refuted by Mr. Parrish, on the ground that Mr. Deeds sports a six-cylinder, self-starter mustache, while the stranger's upper lip is as naked as a soft-shelled egg. To a Firing Line man the stranger made this explanation:

"You see, it's this way: I went up to Atlantic City, and when I was about ready to start back I decided to cut off my mustache, which I did. And now these fellows here don't know me without it, and so far I've been unable to prove it. The only way out of it, they say, is for me to hang around till it grows back long enough for them to recognize me."

And in the meantime everybody down there is as nervous as a caged coyote and some have begun to suspect the stranger to be the real goods.—Nashville Tennessean.

HE WAS THIS AND THAT, BUT HE FELL FOR WAGONS

An acquisition to the sales force of the Milburn Wagon Co. is S. H. Smith, president of the Hughes Buggy Co., Lynchburg, Va.; president of the Savannah Buggy Co., Savannah, Ga.; and ex-president of the Taylor-Cannady Buggy Co., Oxford, N. C. Mr. Smith found the buggy game a little quiet for the past season or so, it is said, and decided to get into a "real live proposition"—the wagon game.

Mr. Smith will travel North Carolina, South Carolina, and Virginia, making his headquarters at Charlotte, N. C.

NEW STORAGE BATTERY

To the public who use accumulators there is only one way to make them, and that is with lead plates, oxides of lead, and dilute sulphuric acid. That the conventional accumulator made on text-book lines is doing splendid work no one would deny. There is a battery now which in every essential differs from the lead battery, and has many advantages that the other has not.

This battery, known as the Alklum, is of English origin and its claim indestructibility as compared with the lead cell. It is practically of all-steel construction, and can be subjected to any amount of mechanical rough usage and vibration. It has no lead grids, celluloid or vulcanite case; even the brass terminals give place to steel connecting lugs and nuts. The containing case is of steel, light yet strong, with hermetically sealed cover. It is a very lightweight battery, and, for equal output of energy, in watt-hours, shows to great advantage with a lead battery of equal capacity. It effects a marked economy in weight and space. There is no acid in this cell, but, on the contrary, an alkaline solution.

Electrically its properties are more advantageous than its properties of great mechanical strength. It can be rapidly charged by sending so heavy a current through it that no lead battery would stand without injury. Alklum cell improves, it is alleged, the harder the work it is put to. The discharge

per cent. solution of pure caustic potash in distilled water. It is a remarkable fact that this alkaline solution does not change in the processes of charge and discharge, and the quantity of electrolyte in a given size of cell is reduced to the smallest amount, thus saving weight and cost of electrolyte. A few interesting facts bearing on the capacity and efficiency of the battery may be given. Per pound weight it gives 13 watt-hours, increasing to 16 watt-hours with the size of the battery. The normal watt-hour efficiency is 65 per cent., which can be increased to 75 per cent. if only two-thirds of the capacity be used. The normal ampere-hour efficiency is 85 per cent., which can likewise be increased to 95 ampere-hours. Every cell is rated at full continuous discharge, thus a 40 ampere-hour battery would actually light a 1 ampere lamp for 40 hours right off the reel, and for a much longer period if used intermittently. Neither heat nor cold has any effect on the efficiency and the electrolyte does not freeze till minus 30 centigrade, which does not interfere with the working of the cell. Although the voltage per cell is, on discharge, 1.2 compared with 2 volts for the lead cell, an equal size battery will actually give more output than the latter. Thus the smallest two-cell battery, giving only 2.5 volts, lights brilliantly a 2 candle power lamp taking 1 ampere. As output is made up of two factors, viz., amperes and volts multiplied together, a lower voltage can obviously be compensated for by having more amperes in the circuit, and vice versa, and this cell, with its closely packed plates, only

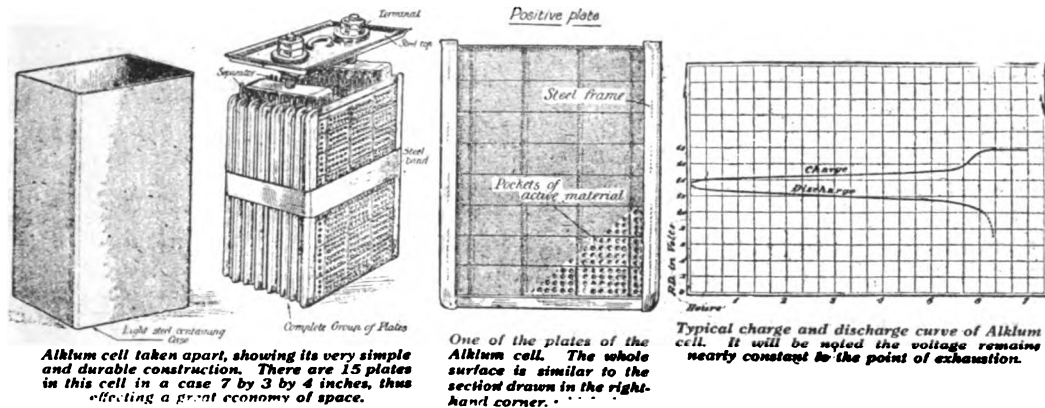

Alklum cell taken apart, showing its very simple and durable construction. There are 15 plates in this cell in a case 7 by 3 by 4 inches, thus effecting a great economy of space.

One of the plates of the Alklum cell. The whole surface is similar to the section drawn in the right-hand corner.

Typical charge and discharge curve of Alklum cell. It will be noted the voltage remains nearly constant to the point of exhaustion.

possesses the valuable feature that the full strength of current is maintained right up to the point of exhaustion, as a discharge curve shows.

If the average volts per cell be taken during discharge at 1.2, the lowest voltage will be just over 1 volt, and this is immediately before the point of exhaustion, when it suddenly drops to zero. Retention of the charge for an indefinite period is another excellent characteristic. It can be left standing without any attention for any period—a year or even two years—and will be found to have lost practically none of its charge. Neglect of this kind would ruin an ordinary lead battery by the rapid sulphating which would occur.

The plate consists of a light steel frame embracing two thin sheets of perforated nickel, made up of ribbons joined together. These sheets are pressed out in such manner as to form pockets, into which is tightly packed the active material, which for the positives consists of oxyhydrate of nickel mixed with graphite. The negative acting material is made up principally of an alloy of iron and cadmium in a state of fine subdivision. The active material is enclosed in the nickel pockets, which forms a protection. Examination of one of the plates fails to disclose any active material, but simply the perforated indestructible nickel surface. A suitable number of plates are grouped together to form the required capacity of cell and secured by a steel band, the terminal lugs being welded on. The plates are packed very close together and, as a result, the cell has an extremely low internal resistance. The electrolyte, which corresponds to the sulphuric acid in the ordinary accumulator, is made of a 20

3/16th in. thick, and very large surface, is specially adapted for relatively high discharges in amperes. A wide range of sizes and voltages is made, the standard varying from 6¼ volts to 12½ volts, and up to 100 ampere-hours capacity. For electric engine starters this battery is perfectly adapted to the severe conditions of heavy charging and discharging, points on which the ordinary cell is very prone to fail.

LIGHT CAR VS. CYCLECAR

Though the terms light car and cyclecar are used indiscriminately to refer to any type of miniature car, the words really apply to two entirely different types.

The light car, generally speaking, is a miniature motor car, while the cyclecar is something new—a passenger-carrying machine built on novel lines, very simple in construction, light in weight, and hence generally considered to be more speedy and more economical to run than the light car.

At the present time the trend of public favor is rather toward the light car than the cyclecar, says McM. in an English journal, giving the English view, probably because the largest manufacturers of motor cars or motor-bicycles who have gone into the new motoring movement have preferred to devote themselves to the perfection of the miniature car on well-tried lines rather than to experimenting with something new and novel, such as the cyclecar.

Many of those who have been bold enough to venture into this interesting field of research have, unfortunately, in the past

lacked capital or great experience, with the result that their early efforts were crude and curious, and so did much harm to the cyclecar movement as a whole. But in spite of this, it is quite possible—not to say probable—that, in the course of the next twelve months, we shall see a reversion in favor of the simpler type of machine, for as soon as this simple type of machine is being manufactured commercially and turned out in the proper manner, then, by reason of its low price (made possible by its very simplicity) it will be able to command a far larger market than the miniature car type.

This, then, is the situation at the present time, and it is a particularly interesting situation to one who, like myself, has had a very wide experience not only with the simpler types of machine, but also with the latest light car productions. Consequently, a summary of experiences gained with each class of machine may be of interest to others.

My experiences with light cars have been mostly with Singer, Stellite and Morris-Oxford, a thousand miles running having been done with each of these, and with cyclecars my running has been done on Morgans and G. N.s.

While the latter are undoubtedly much more economical to run than the former, their light weight accounting for the wonderful economy of gasoline, oil and tires, there is more to do to them in the garage in the direction of small repairs and replacements than to the light car.

The light car, when really well built, does not give trouble in its minor details, though when a serious breakdown does occur it is much more expensive to repair than a cyclecar. Only the other day, for instance, I doubled up the front axle of a light car, and the bill for the spare came to \$50. Had this been the case with the Morgan or G.N., the cost would probably have been less than one-third; and other items will probably be charged for at the same rate.

The number of small replacements and adjustments having to be made to cyclecars I attribute to their higher speed, for though there is no doubt that a good cyclecar is a much more sporting and speedy mount than the average light car, one pays for this in the number of minor adjustments that is necessary.

The cyclecar, too, from the very fact of its being made to go faster, holds the road infinitely better than the average light car. The latter seems, by comparison with the cyclecar, to be heavy and to dance and sway on rough roads and on corners, even though it travels at a lower average speed than the cyclecar.

The light car, I have found, however, easier and pleasanter to drive than the average cyclecar. It is smoother running, its four-cylinder engine, which can be started by a pull up from the handle, providing a great contrast to the uneven impulses of the V twin. Its flexibility, too, is superior to the V engine, and the ability to tick down to 5 miles an hour on top gear and to accelerate easily to 30 miles an hour is a charm which every light car owner will appreciate.

Apart from the inefficient springing and the proclivity to dance on bumpy roads, the light car certainly gives one more comfort than the cyclecar. There is a nice side door, a well-upholstered seat, adjustable windscreen, a hood, and distinctly more room for the driver and passenger than in the case of the average cyclecar.

Summing up, the points of each type will be found to be as follows:

Light Car—More reliable, more comfortable, and more easily handled.

Cyclecar—Much faster on hills and the level, more economical in gasoline, oil and tires, serious repairs and replacements cost less, but minor repairs are more frequent.

A machine possessing the advantages of both the light car and the cyclecar, and none of the disadvantages, would be a very delightful instrument to handle. Surely, therefore, there must be a vast opening for the man who first produces the perfectly and luxuriously finished cyclecar, the machine constructed on the simplest lines to attain a moderate speed, to

hold the road like a leech, and to be as comfortable and as well sprung as a large car.

Given a handsome appearance, this type of machine should enjoy an enormous sale. Assuming the other points to be equally good, owing to its simple construction, this is bound to be sold at a lower figure than any light car of standard design, and for that reason it should prove, if ever produced in quantities, a serious rival to the present ever-popular sidecar.

IRON ORE OUTPUT IN 1913 LARGEST EVER

According to statistics recently completed by the United States Geological Survey, the production and shipments of iron ore in the United States exceeded those of any previous year. The crude iron ore mined in the United States in 1913 amounted to 61,980,437 long tons, compared with 55,150,147 tons mined in 1912—an increase of 6,830,290 tons, or 12.38 per cent. The iron ore shipped from the mines in the United States in 1913 amounted to 59,643,098 long tons, valued at \$130,905,558, compared with 57,017,614 long tons, valued at \$107,050,153, marketed in 1912—an increase in quantity of 2,625,484 long tons, or 4.60 per cent., and in value of \$23,855,405, or 22.28 per cent. The average price of ore per ton for the whole country in 1913 was \$2.19, compared with \$1.88 in 1912. These quantities of ore, both mined and marketed, include the iron ore used for fluxing other metallic ores at smelters in the middle and western states, but do not include the iron ore sold for the manufacture of paint. The iron ore marketed for paint in 1913 amounted to 16,950 long tons, valued at \$44,851. The ore reported as sold for fluxing purposes other than in the manufacture of pig iron amounted to 62,842 long tons, valued at \$235,588, in 1913, compared with 88,449 long tons, valued at \$244,315, in 1912. The domestic iron ore actually marketed for the manufacture of pig iron amounted in 1913 to 59,580,256 long tons, valued at \$130,669,970, compared with 56,929,165 long tons, valued at \$106,805,838, in 1912.

WIDTH OF VEHICLE WHEELS SPECIFIED IN ITALY

Rigid regulations covering the width of vehicle tire treads are being made by the Italian government. The computations which determine the breadth of a wheel rim on a certain wagon are based upon its gross weight, and this, in a single axle vehicle, must not exceed 50 metric quintals (1 metric quintal=220.46 lbs.), or 80 metric quintals in the case of two axles. With a wagon of four wheels, weighing between 50 and 80 metric quintals gross, the width of the rim is placed at 100 millimeters (3.9 in.). The ratio varies considerably with lighter wagons. With power-driven vehicles, one and a half metric quintals gross weight is allowed for each centimeter of rim width. No rim, however, is allowed to be narrower than 10 centimeters (3.9 in.), and all vehicles, whether animal or power-propelled, must have flat tires.

FAIL TO SEE INQUIRIES FOR BUGGIES

F. C. Enright, commercial representative of the Chicago Association of Commerce at Buenos Aires, cables to Chicago headquarters regarding the possibilities for trade there:

Have inquiries for millinery, shirtings of cotton, linen, silk, cotton white prints, boxcalf kids colored black, glace samples, whole skins, linings, sundries shoe factories, 300 tons soft galvanized wire for weaving, also tinned aluminum, copper bronze wire, perforated steel, iron, copper, bronze, zinc sheets, sieve frames, toothpicks. Send samples, prices, full particulars. Wish samples, hardware, tools, rubber and leather goods. Future prospects good. Do not advise sending salesmen at this time. Work through this office and local representatives who know trade. No orders can be expected till November.

MOTOR TRUCK CONVENTION COMPLETE

The motor truck convention, to be held in Detroit on October 7-10, gives promise of being a great motor convention. The program for the four days has been drafted with the object of taking up questions of direct value to the truck maker, dealer and owner. The opening of the convention will be given over exclusively to manufacturers, when subjects of direct value to them will be handled.

Thursday will have forenoon and afternoon sessions on subjects which concern both manufacturers and dealers.

Friday will be dealers' day and will be on questions of truck guarantees and service that manufacturers and dealers should give. These questions will be handled by representatives of the manufacturers and also by dealers. Many dealers have been invited to participate in the discussion.

Saturday forenoon will be cleanup session on subjects that have not been completed during the three previous days. There will also be a discussion of subjects, such as the necessity for dealers' organizations, the desirability of some form of motor truck exhibitions, and other questions. Many of the subjects are now definitely decided upon.

"The Trading Evil" will be handled by one or two makers and several dealers. This is considered one of the most pertinent topics. Dealers have been allowing too liberally on used trucks. The object of the paper and the discussions will be to show how this evil can be reduced, as well as to offer means for making this business more profitable to the dealer.

"Evils from Overloading and Overspeeding and Avoiding Too Heavy Bodies" is another subject to be discussed. Manufacturers, dealers and body makers have been invited to discuss different aspects of this question. Axle and spring manufacturers have also been invited to participate.

"Used-Truck Market Reports" has been listed as a subject.

"Traffic Engineering" will be handled by at least two experts in this line.

"How to Calculate Costs," a question many manufacturers and dealers are asking themselves, will be analyzed in special papers.

"Territorial Lines for Dealers" will be handled by two or three makers. There is a movement to restrict dealers' territories and demand more intensified selling efforts.

"Tires for Motor Trucks" will be one department of the convention to be handled by four of the leading truck manufacturers who have been invited to prepare papers specially for the benefit of makers and dealers.

One manufacturer has agreed to present a paper entitled, "Parts to be Carried in Stock by Dealers."

There are many other subjects that will be brought up, among which are:

"Loading Devices, Their Merits and Shortcomings."

"Driver's Influence on Successful Operation."

"How Manufacturer Can Co-operate with Dealer in Advertising."

"The Export Business, Best Fields and How to Develop."

"Motor Truck on the Farm."

Already the local committee has made active progress. Headquarters and all convention sessions will be in the Hotel Cadillac. The pleasure of those attending the convention is being well looked after. On Wednesday there will be a Dutch lunch with cabaret. Thursday evening the Detroit committee will tender a theatre party to all delegates. On Friday evening the official banquet will take place.

A TRUCK BUILDER'S VIEW

By B. A. Gramm

One of the finest things in the carriage and wagon business is the C. B. N. A. They have accomplished a wonderful lot of good to themselves, and while their business has to be worked along far more economical lines than the motor truck

business, they certainly operate much more profitably than we do.

The great trouble with the truck situation today is the fact that even the leading truck builders are working along so many different lines and they are seemingly at loggerheads all the time. Truck salesmen are going out after sales with one idea that seems to be paramount, to try to get the order, at no matter what cost or method that will be the most successful, and if they think in their own minds that it is necessary to knock the truck business in general, they do not hesitate to do it. It has been our experience to hear some of the foulest expressions from representatives of first class concerns we have ever listened to. These actions not only hurt the concern they represent, but it is hurting the motor truck industry in general, but what is injuring the truck business more than anything else in this country today is the great difference in prices and the fact that customers are unable to distinguish the difference in wearing and lasting qualities of these trucks with these different prices. Take for instance, two concerns, each one will show their specifications and show to the customer that they use a certain well known make of motor, transmission and axles, and there will be a great difference in price. Naturally the lowest priced man will often land the order because the customer is not able to see the difference. They will talk about guarantees in a very strange way, when they do not know whether their company will be in existence twelve months after the truck is delivered or not, and certainly will not be from the methods they are using.

By making a careful investigation find that while they are using the same make of material, they are under size for the real carrying capacity and work that must be accomplished. This reduces the cost of building their truck \$500 or \$600, which means a loss in the end to the customer, for his truck cannot absolutely stand up under the work he has figured on its doing. It means the ultimate breaking up of the concern that manufactures it, it hurts the parts manufacturer who has been supplying parts, and above all, it hurts the truck industry in general.

The cure for all this will be a strong motor truck organization, in which no manufacturer could become a member unless the truck that he manufactured came up to certain standards as would be provided by a competent board of engineers, in which horsepower, size of gears, kinds of material used and carrying capacity of axles and springs on every model advertised, were used.

A plan could be thoroughly worked out so that a plate, for instance, could be used and attached to the dash of every truck sold by a member of this organization, and then by advertising by this association placing before the public the names of these manufacturers or members and educating the public so they would understand in any truck that had its name plate on the dash, they would have safety and security in the knowledge that the truck they purchased was certainly right for the work they intended it to do. It may be a little bit difficult for us to explain just how to work this matter out, but we are satisfied it could be done.

DEVICE FOR SECURING NUTS

Spring washers and split pins are the most favored means for securing the nuts on the ends of bolts in automobile construction in cases where they afford sufficient security, while locknuts of the depth required for real efficiency are deprecated for looking clumsy and adding to the necessary length of the bolts. New devices intended to supply the long felt want of a thoroughly acceptable contrivance are therefore constantly forthcoming, while automobile and accessory designers, on the other hand, strive to reduce the number of bolts used in a construction to a minimum, even resorting to riveting in many instances, on the plan that the riveted end of a bolt can be chiseled off, in case of necessity for taking the construction apart, and the bolt replaced. Retaining flanges and autogenous

welding are also employed more and more where formerly bolts and nuts abounded.

The latest locking device, heralded from France, is shown herewith and has been tested at the laboratory of the Conservatory of Arts and Trades. It was here shown that a locknut turned on with a pressure of 5 kilograms at the end of a wrench .40 meter long came completely loose after 80 shocks, while the autobloc, as the new device is called, though secured by hand only, remained in its place after 103,000 blows. It was also found that the work required for turning an autobloc nut without its locking piece amounted to 3.2 gram-meters, while with

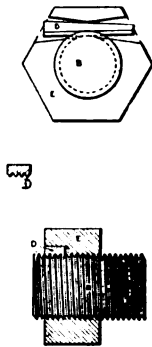

this piece in place the work required rose to 2,270 gram-meters. Prolonged use of the device on the locomotives of the Metropolitan in Paris has confirmed these results.

A peculiarly shaped slot in the nut and the locking-pin constitute the whole provision, the bolt remaining whole and no longer than needed for taking the nut. The slot has a rocking-edge on its outer side and a curve on its inner side. The pin has rectangular faces and is thinner at one end than at the other; the face turned toward the bolt is grooved lengthwise to correspond with the thread of the bolt. It seems that the grooves are straight. When the pin is driven into its place, it is squeezed between the sharp ridge on the outer wall of the slot in the nut and the much larger contact surface with the threads of the bolt. When a tendency to loosening of the nut manifests itself, the pin therefore turns with the bolt and is wedged the harder in the slot the stronger the tendency to loosening becomes.—*Omnia.*

OF COURSE IT WON'T BE POSTPONED—READ WHAT THE BOSS SAYS

There have been reports that the Exposition, because of the war in Europe, would be postponed. It will not be postponed.

There have been published statements that the war in Europe would seriously affect the commercial or educational importance or the financial success of the Exposition. They will not be so affected.

The Exposition will open on its scheduled date—February 20, 1915. It will be completely ready when open. It is more than 90 per cent. completed today. Nothing will be permitted to interfere with the consummation of the plans originally laid down.

Many friends and parties in interest have presented arguments in support of postponement for a year. These have been given anxious study and careful analysis. Most of them are merely counsels of timidity, based on nothing save a general feeling of doubt and uncertainty. These are sufficiently answered by saying that there is no longer any doubt or uncertainty as to the success of the Exposition whatever the situation in Europe may be. Other arguments for postponement have some practical foundation, but for every one of these there is a stronger and better argument for proceeding with our plans.

The Exposition will, therefore, open as scheduled. There is not the slightest reason to believe its success, in any phase, will be any less than that which was so certain before European

war broke out. Not one of the nations at war has notified us of an intention to withdraw her participation; France and Italy have in fact notified us that their plans remain unchanged, but even if we should lose the others the interest and importance of the Exposition would still as a whole, surpass all precedent.

As to the domestic participation, the effect of the European war seems likely to be rather advantageous than otherwise. The stimulus on exhibits is already felt, as American manufacturers become impressed with the opportunity given by the Exposition for bringing their goods to the attention of the large distributors of Central-South America, the Orient and Canada.

(Signed) CHAS. C. MOORE, President.

HOW TO TEST AUTOMOBILE ENGINES

There are several methods of testing automobile engines. The laboratory method is used to a great extent privately and to a certain extent in public tests. In a laboratory the engine is generally tested out of the chassis on a separate frame, but some laboratories are equipped to test an engine in the car by absorbing the power from the rear wheels.

The average long distance race is one of the best engine tests that can be made, take it from a Franklin engineer, but it is so seldom made with stock cars that its value in the development of the automobile industry and in what it shows to the public is a much debated question. High speed racing, either on the road or on the track, has narrowed down to special cars in practically all events.

The most severe tests an engine can be given to determine its cooling and reliability, is a low gear run of sufficient duration to show its ability along the above lines. One hundred miles on low gear, at an average of 10 miles an hour, especially if the roads are heavy, will show more of the ruggedness and ability to withstand the most severe service, than any test known today, and anybody can make the test.

SIRE, YER 'UMBLE SERVANTS!

Years ago this is the kind of petition the late King Edward received from the coach builders: "May it please Your Majesty.—This Memorial of your humble servants the Council of the Institute of British Carriage Manufacturers (Incorporated) showeth that the use of suitable carriages by the nobility and others attending State ceremonials has been allowed in some degree to fall into disuse. Your memorialists humbly pray that Your Majesty will be graciously pleased to express the desire that all those having the privilege of access to the Royal Presence shall use for their conveyance equipages befitting their rank, and more in accordance with the high example of Your Majesty's State Carriages, and those used by the members of the Royal Family. They feel that any retrogression in the external evidence of dignity with relation to any public event in which the person of Your Most Gracious Majesty is concerned, would be detrimental to the loyal character of our Nation, and to that support of the Throne which should be the pride and glory of every subject throughout Your Majesty's Dominions."

LUMBER SPLITS

Lumber splits at the ends because the sap tubes, being open, cause the ends to dry out before the rest of the wood can get dry, and the shrinkage of the dried wood pulls itself apart because the portion which is green cannot compress itself under the strain of seasoning, hence the appearance of the cracks which damage the lumber so much. But with the soft wood strips securely fastened to the ends, the drying out takes place evenly all through the plank, and there is no inducement for one portion to split away from any other portion and the plank remains in perfect condition during the drying operation.

GOOD ADVICE AS TO CATALOGS

Consider for a moment how you dispose of your morning mail. You pick out the dozen or two letters, pile a bushel of catalogs, circulars, post cards, sample magazines and house organs up on your desk (many of them not even unwrapped). get your waste basket quite convenient and scrape the whole lot into the basket, seeing meanwhile, a disturbing vision of your own advertising matter tarveling the same route.

One of the great problems in distribution is how to do less printing for the waste basket.

Have you ever stopped to think why you consign all this material to the furnace room instead of putting it away in the bookcase? If so, you have found that it would not go in the case and in any event it was not worth saving. These are two serious indictments against the trade catalog; lack of uniformity and general worthlessness.

There was once published a request for catalogs by members of an association. Twenty-eight concerns responded with 81 pieces of printed matter in 30 sizes, differing from each other by at least a half inch in one dimension, as shown by the following list. Additional variety is given by some showing the same dimensions opening end side: 3½ x 6¼, 6 x 9, 7 x 10, 10¼ x 15¼, 10¼ x 23, 9½ x 11, 21½ x 28½, 8½ x 11, 21½ x 28½, 8½ x 11, 4¼ x 9, 6¼ x 6¾, 22 x 34, 8¼ x 12½, 8¼ x 15, 5½ x 7¾, 8 x 14, 6 x 9½, 7 x 9, 5½ x 9½, 6¾ x 10½, 6½ x 9, 9 x 14, 9 x 12, 7 x 10½, 18 x 24, 6½ x 9½, 5½ x 8½, 21½ x 32½, 6½ x 8½, 7¼ x 14, 5 x 7½.

Honestly, what will hold this mess but the waste basket? What chance of consideration has a 21½ x 28½ in. folder, printed on both sides?

The catalogs proper had the following sizes: 6 x 9, end and side; 7 x 10, end; 4¼ x 9, end and side; 8 x 11, side; 5½ x 7¾, side; 6 x 9½, end; 7 x 9, side; 6¾ x 10½, side; 6½ x 9, side; 9¼ x 12, side; 8½ x 11, side; 5½ x 8½, side; 5 x 7½, side; 5½ x 8, side.

These naturally group into four classes: 6 x 9 in., 7 x 10 in., 8 x 11 in., and 9 x 12 in., with the 6 x 9 in. side opening having a decided lead, there being 13 catalogs of this sort received. Of the four, it would seem as though two could be eliminated, leaving two standard sizes from which a quarter inch should be the maximum variation.

With the evidence before you, a true bill must be found. The lack of uniformity is appalling, and no self respecting bookcase wants to house any such collection.

The expense incident to catalogs should not be charged to advertising, as it really is not advertising, but a necessary evil.

The purpose of the catalog is twofold. First and most important, it is to sell goods. The second, and really minor aim, is to sell your goods. The order of importance is based on the belief that every vehicle placed sells at least one more, and while your competitor may land the first order, you have an even chance at the whole succeeding business, growing in geometrical progression through the years.

When, for any reason, the catalog makes a premature trip to the furnace, this business is lost or indefinitely postponed. On the other hand, if it has about it that which saves it from the fire, it has a chance to perform its mission. Preservation is essential.

We save our valuables and throw away what we regard as worthless. Preservation depends entirely on appearance of value. This may be an external appearance, e.g., a fine binding; it may be the contents, or a combination of both. The most of us have catalogs we never look at, never expect to look at, and which we know are entirely out of date, yet which we cannot bring ourselves to discard because the cover is fine. On the other hand, the yellow almanac hanging by the side of the kitchen mirror was never preserved for its binding, yet you know your mother could go to the upper pantry shelf and get the one of your natal year with the important date plainly

marked, and on the opposite page would still be proclaimed the virtues of a famous liniment "good for man and beast"!

Possibly the buggy man can learn a few things from the almanac. Look inside: signs of the zodiac, phases of the moon, coming eclipses, morning and evening stars, comets expected. Church holidays, principal dates in history, birth stones, language of flowers, interpretations of dreams, prophesies of weather, how to clean fabrics, and so on. A book of interest and reference for the scientific, the religious, the sentimental, the credulous, the incredulous, the practical, and not even forgotten some jokes and pictures for the children. A book of reference, of information.

We are all so constituted that we cannot throw away books of reference. A half dozen standard tables culled almost at random from the Smithsonian tables will insure preservation. A short historical sketch is extremely hard to part with, and few indeed can deliberately burn a cloth binding.

Few vehicles now are sold directly to the user by the maker, dealers being interposed. The dealer can not be an exclusive buggy man and is really apt to know less about the goods than some lines carried.

Except in rare cases your catalog is the only salesman you ever send to the ultimate consumer, and it must be prepared with the single purpose of selling him a buggy.

Could you send a salesman Your catalog must have the corresponding characteristics: in its place you would insist responding characteristics: that he be qualified for the job; that he should

- Not be a freak.....Standard size.
- Be well dressed, neat.....Attractive cover.
- Have a good address.....Good paper, printing and illustrations.

- Be a good talker.....Well written.
- Know vehicles in theory and practiceTreatment of the essential points of your vehicles, detailed, accurate and convincing.

- Know your buggy thoroughlyTables of sizes, guarantees, net retail prices and inquiry and order blanks to be torn out and mailed.

- Be equipped with prices, guarantees and order blanksThe corresponding equipment of a catalog may consist of shadow cuts, tables, interesting applications, and so on. The impression must be so favorable that the catalog will be preserved and the order sent in.

When a man is buying his first job the things he wants to know are quite different from the points he will consider after he has experience. The salesman can furnish the desired information and the catalog must do likewise.

The customer is intelligent. When you get him to looking through your catalog his attention is gained, his interest aroused and you have only to convince him to close the deal. Your problem is to take care that the attention is not distracted, that confidence is inspired and that the interest increases to the climax—an order blank to be signed and torn out. Grandiloquent language, catch phrases or extravagant claims have no place in a catalog, nor has display type. These all distract the attention and create distrust. At best they are but devices to gain attention, to arouse curiosity.

A catalog is a compendium of information. It should contain facts—just plain facts.

Close with your prices, guarantee, terms and an order blank and remember that the weakest expression that ever entered a catalog is, "For further information write the office." If you have any further information, put it in. An interested prospect

will write about special conditions to be met, without solicitation, and the principal function of the catalog is to supply all required information in advance, and minimize correspondence.

To sum up.

Purpose:

- (a) To sell vehicles.
- (b) To sell your vehicle.

Avoid the waste basket:

- (a) By making in book form and size—preferably 6 x 9 or 8 x 11 in.
- (b) By putting in really valuable information.
- (c) By having it well printed on good paper with good cuts.

Make effective as a selling agent by:

- (a) Attractive appearance throughout.
- (b) Giving definite information in a straightforward manner.
- (c) Avoiding anything which will distract the attention from your selling talk, e.g., display type.
- (d) Avoiding vague, indefinite or extravagant claims.
- (e) Giving rating, principal dimensions and net prices for each size.
- (f) Having order blank bound in so it will not get lost.

As a man is judged by his clothes, and these really constitute the most of his appearance, so a manufacturer is judged by his catalog, which is usually the only thing the customer has available for the purpose, previous to the actual purchase. A cheap catalog will certainly convey the impression of cheap product. On the other hand, good catalogs are expensive to produce and care must be taken that they are not wasted. Dealers supplied with them should be willing to send in an account of each catalog disposed of with an estimate of the value of the prospect. Mailing cards could be supplied to the dealer for the purpose, and a follow up system might prove profitable. Besides keeping track of the catalogs, this would assist in checking up the activities and effectiveness of the dealer.

REIN HOLDER IDEA

Possibly some buggy builder can make use of the little idea for a rein holder attached to seat of buggy. It might prove a selling point that would interest when talking up the job to the prospect.

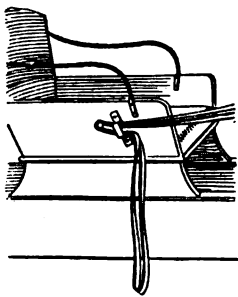

A piece of strap iron, $\frac{7}{8}$ in. wide, is bent as shown and fastened to the side of the seat with screws. A peg or bolt is attached to the seat, back of the opening in the strap iron. If a bolt is used, it should have threads long enough to permit a nut to be placed on each side of the seat end, allowing the head to extend on the outside. The ends of the reins can be doubled and inserted in the opening of the bent iron, and then looped over the bolt or pin.

THICK LEATHER BELTING

Many buyers of leather belting demand the thickest and heaviest leather they can obtain for their money. Some specify "to weigh 16 ounces to the square foot and $\frac{1}{4}$ inch thick." The weight and thickness of a leather belt are no indications of quality, for leather can be artificially puffed to any desired thickness and as easily weighted. You don't want weight and

thickness because it costs big money to pull excess weight and bend a thick, unwieldy belt every time it goes around the pulley. What you want is the lightest weight and the greatest pliability consistent with the use to which the belt is to be put.

It has been found by experiments that the difference in power that can be transmitted by the same belt in damp and dry weather may vary as much as 50 per cent., especially if the drive is a vertical one; that is, if in general, the pulleys are placed in an unfavorable position.

DOES YOUR GLUE CONTAIN FORMALIN?

For a number of years glue manufacturers have had difficulty in boiling down the hide pieces and trimmings received during the summer. The pieces do not dissolve, they yield a poor result in regard to quantity, and the glue is of indifferent quality, and in some cases almost worthless. Careful experiments have shown that these difficulties are due to the treatment of raw hides with formalin or disinfectants containing this chemical, as it has been found in glue pieces which were not properly dissolved by boiling.

Formalin is a 40 per cent. solution of formaldehyde gas in water. It would be an ideal product for the preservation and disinfection of raw hides if it had not the property of tanning the gelatinous substance of the hides and making it quite insoluble. The more concentrated the solution of formalin used, and the longer it is allowed to act on hides, the more insoluble will the gelatinous matter become, until it may be entirely unaffected by water. It is then impossible to reduce the pieces and trimmings of hides by boiling, and the fleshy parts become red, quite hard and shrunken. The deposit formed at the bottom of the boiler consists chiefly of small pieces of hardened glue, pieces which will not go into solution even after several days' boiling. These will not make glue, and are therefore quite worthless.

MANILLA ROPE AS STRONG AS BAR OF STEEL

Weight for weight, a Manilla rope used for power transmission is as strong as a solid bar of steel, according to authorities. On the other hand, the same rope is only 11½ per cent. as strong when its cross section is the same as that of the metal. Leather, such as is used for belting, has only 5 per cent. the strength of steel of a like cross section, and is less than 40 per cent. as strong when it is of corresponding weight. The efficiency of rope and leather for the transmission of power, however, is not proportional to their respective strengths, owing to the fact that internally the two are constructed, and wear, differently. Fibers from which rope is made are usually from 8 to 10 feet in length, and possess material longitudinal strength, but lack that quality transversely. It is this which causes the fibers to be broken into short pieces within a rope, making it sometimes dangerous, although apparently strong externally.

SLIDE RULE WITH NEW FEATURES

New features designed to add to the usefulness of that common tool of the mechanic, the measuring rule, are embodied in a new interlocking slide rule that has just made its appearance on the market. When the rule is closed all the slides except the first are locked together by spring-locking devices, and as this is pulled out, the slides are released in consecutive order until the rule is fully extended. The same locking devices then hold the rule in the extended position, and it is closed in the reverse order to that followed in extending it, the first slide being released by pressure on a spring. With this arrangement there is no danger of the parts sliding on each other while the rule is being used. On the back the figures are so arranged that they show at a glance the distance spanned by the rule when partly extended. This feature is designed to make easy the reading of inside measurements.

CO-OPERATING WITH THE DEALER

Co-operation means the pulling together of two or more interests for a common purpose. When manufacturer and dealer pull together the purpose is increased sales.

Salesmanship is the upbuilding from a solid foundation and should represent industrial progress and not commercial warfare. It must be based on honesty, as trickery represents lost energy and wasted force. Unless salesmanship is equally essential to the buyer and seller it loses its purpose. The modern salesman is no longer a strategist plotting against his customer, but he is a representative of his house and a guardian of his patrons' interest. He serves both best by serving them honestly.

The salesman who is governed by co-operative ideas is successful because he builds confidence with his house and his trade. He builds up the friendship of both for each other and makes today's sales bring repeat orders tomorrow.

Co-operation on sales must start in the office of the sales manager and he must have the support and co-operation of the general manager and factory organization, without which no sales organization can long succeed. A well worked out service organization at the home office is very essential. It costs money to keep salesmen on the road—paying salaries, railroad fare and hotel bills, and to get prospects and convert them into orders, into real dollars with a balance on the right side of the ledger. This expense can be reduced by good support from the home office.

How many of you co-operate with your salesmen with a well organized follow-up campaign? How many go still further in getting a list of all real prospective buyers from the dealers and follow them up in the same manner, giving the dealer good support and assisting him in selling the vehicles he has put in stock? Good letters and printed matter pave the way for your dealers and a salesman, and enables them to turn in many nice orders they otherwise would never secure, and help to reduce the high cost of selling.

Direct your salesmen to send in a complete report on each prospect and furnish proper blanks that require as little time as possible to fill in and bring it to you in good form. This enables you to put the personal touch into one or more of your letters and to write intelligently. Form letters are all right to fill in, but the real effective letter is the one that carries the personal reference which convinces each prospect that you are taking a personal interest in him and writing him individually. This builds good will ahead of your salesman and dealer. It often means an order instead of a lack of interest or a flat turndown.

Honesty and integrity of the manufacturer and salesman with the dealer is most important. It is to be regretted that some of the dealers have become skeptical and hesitate in giving up a list of their prospects on account of the unscrupulous and short-sighted methods employed by some of the manufacturers or their salesmen in not giving the dealer proper protection.

One of the most important duties of your sales department is to educate the dealer on the cost of doing business, and this can be done most effectively through the salesmen. When the dealer knows his true cost there will be less price cutting, and he will be able to give his customers the kind of service that will eliminate mail order competition. Another important move in which we can assist and educate the dealer is in the organization of local clubs. This brings the dealers together, enables them to co-operate with each other, placing the business on a higher plane, and is the most effective way to eliminate undesirable competition and the price cutting evil.

Price cutting among retailers will not bring any real advantage to the consumer. According to commercial reports, fully 50 per cent. of the retailers are barely able to keep the wolf from the door and make a fair living; 53 per cent. gradually lose out and go into bankruptcy or retire. Only 15 per cent. really make any money, and very few of these become wealthy.

It is plain, therefore, that price cutting means a reduction in quality or service. Maintaining prices means greater competition in quality and service which is of far more benefit to the consumer than a small saving through a cut price.

From the manufacturer's or jobber's standpoint, nothing will have a more serious effect on sales or put him out of business any quicker than price cutting, for it is only natural that the dealer will push the vehicle on which the retail profit still exists and discontinue the one on which prices have been demoralized and profit destroyed. The only hope for the manufacturer who has demoralized his prices through a nervous desire to get the order away from the other fellow is to build a junior or cheaper line.

There is a bill in Congress saying that the manufacturer may bind the dealer to sell his product at one established price. This bill was introduced by Mr. Stevens, of New Hampshire. Suppose the Stevens bill were passed, making it possible for the manufacturer in interstate commerce to really bind the retailer to sell his product at one price. He might ask an exorbitant price, but he can do that now. He always has had and will have the right to sell to retailer or consumer at his own price.

This is an age of service. The position of the dealer in modern business is the result of a movement fostered by the largest and most successful manufacturers and accepted without argument by the progressive buying public. It affords a more convenient market and makes it possible more readily and satisfactorily to serve the public. The dealer's position is therefore that of a public purchasing agent selecting the most suitable lines and rendering the most efficient and economical service to the buying public. The dealer's service is not a luxury, but has become a necessity, and the public is willing to pay the price of good service because it is true economy. The progressive dealer is an indispensable educator and a community builder.

What would you think of a railroad president who received \$35,000 a year, going to another corporation and offering his services for \$25,000 a year? This does not differ from a dealer selling a vehicle plus his service and deliberately cutting the price. He is not cutting the price of the buggy, for the cost on that is fixed, but he is cheapening his selling service.

The best way to avoid price cutting is not to commence it, and we owe the dealers strong support and co-operation in maintaining correct and legitimate prices. Price cutting between dealers means not only a lower margin of profit, or a loss to them, but that the manufacturer and consumer will suffer.

From the manufacturer's knowledge of the cost of production, distribution and service to the consumer, he should be in a position to establish or recommend a reasonable selling price that will maintain the integrity of his own business, progressive competition and protect the consumer from an inferior product, and the dealer will gladly co-operate with the manufacturer in maintaining established prices.

Many dealers are too free in buying, and soon get a large assortment on their floor. This is bad, as they cannot be loyal to any one line and soon lose the confidence of customers. To make a success of any other line, the dealer must standardize on confidence producing lines and convince the farmer he has the ability to select the proper goods for his needs. This builds confidence and good will around the dealer, reduces his investment and enables him to carry a better assortment. Every sale should be made with future business with the same man in mind, for a host of satisfied customers is the best advertising the manufacturer or dealer can get. Here is where quality and service count, and price is always a secondary consideration. The service and benefit the purchaser gets out of his vehicle is the only thing that matters. It must be remembered that "the recollection of quality remains long after the price has been forgotten," and this is truer today than ever before. The one best weapon the dealer has in fighting mail order comp-

tition today is the service he gives his customers. Poor quality and poor service are disastrous for both manufacturer and dealer. The undertaker is the only man who can palm off a "just as good" article without being afraid the user will come back and kick, but he never sells twice to the same user. The manufacturer or dealer who intends to stay in business should not lose sight of quality and good service, which is the true foundation of all modern business.

Another important consideration for the dealer is the company that stands back of what he sells, for as a man is judged by the company he keeps, so is the dealer often judged by the reputation of the company he represents. On the other hand, the company is known by the salesmen and dealers who represent it, which makes it the more important that the manufacturer educate and co-operate with the dealer in extending the kind of service to the consumer that fortifies good will and brings more business from the same territory.

PUTTING ON AXLE CLIPS

A very handy tool for putting on buggy-axle clips can be made of a joint taken from a discarded buggy top. The shape of the tool is shown to the right, and in applying the clips it is used as shown at the left. The tool is not difficult to make.

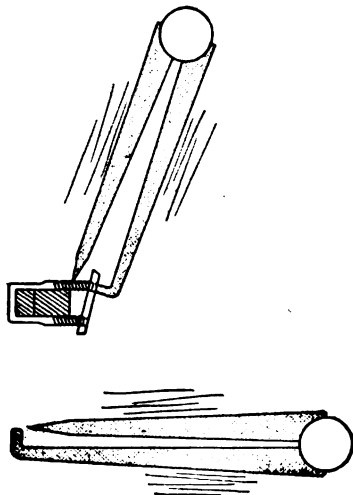

One end of the hinged forging is sharpened and the other turned in at right angles. The yoke ends are easily drawn together with the tool, and the clip slipped over them.

SHRINKAGE OF SEASONED TIMBER

The various kinds of oak, and some other kinds of timber, will shrink more or less every time the surface is dressed off, even a small fraction of an inch. Wheelwrights accustomed to the work are well aware of this fact, and a correct appreciation of it enables them to turn out work of a superior character, even of ordinary materials, by first blocking up the pieces roughly, then allowing the timber to season, and afterward working the various parts by degrees, as the seasoning process becomes more and more complete. White oak spoke timber, for example, may be allowed to remain in its rough state for half a score of years under shelter, without becoming seasoned so thoroughly that the timber will not shrink after the spokes have been dressed out. Carriage wheels have often been made of the choicest quality of oak timber, after every spoke has been seasoned for several years, and, to the great surprise of the wheelwright, every spoke would work in the joints before the vehicle had run three months. The defect in such instances could not be attributed to inferior timber, nor to perfunctory workmanship, but simply to this one circumstance—that the parts of the wheel were put together before the timber had

ceased to shrink. To prove that the best quality of oak will shrink after a spoke has been dressed out, let a tenon be made on one end, and be driven immediately into a mortise; after a few days' exposure in a warm workshop the spokes may be withdrawn with little difficulty. The same fact will hold good in the manufacture of woodwork of any kind where oak is employed for tenons. In order to make joints that will never start, the piece on which the tenons are made should be dressed several times, until the shrinkage has ceased. Then let the tenons be made. After these have shrunk, while exposed to the drying influence of a warm workshop, the spokes or other parts may be driven in their respective places, with the assurance, especially if they are dipped in oil paint previous to driving, that the timber will shrink no more.

REPAIRING A CARRIAGE SHAFT

Shafts are frequently broken off at the breeching or kicking-staple fixing by horses falling. If at the breeching the repair is easily effected by a light steel plate on the under side of the shaft, carried back under the strap-bolt of the strap, with an $\frac{1}{8}$ in. lip turned down on the strap-bolt edge. The fractured part is hidden by a capping encompassing the shaft, so as to look like the ordinary breeching leather or kicking-strap leather. The knack of making the capping of charcoal plate, $\frac{1}{32}$ in. thick, is to cut out stout cord to pattern, folded over the shafts, marking the screw holes, to serve as a template for the iron plate. A mould of hard wood is made, $\frac{1}{16}$ in. less in breadth and width than the size of the shaft, and of the same shape. The plate is bent over this mould, and set in well in the vise, so as to get the exact shape of the shaft. It is taken off the mould after the screw holes have been drilled. This is done by springing it open, avoiding opening the bent corners of the plate by bending it hollow longitudinally along the middle of the top of the plate. This is sprung on over the fractured part of the shaft, and is fixed with tinned screws. The plate is painted and japanned black or brown to resemble the leather of the shaft. This repair will stand the strain of a horse rolling on it quite as well as the sound shaft, if of hickory.

ALLOY OF ALUMINUM FITS MANY USAGES

Claimed to be suited for almost limitless uses, an alloy of aluminum and nickel which does not tarnish and which couples the elements of lightness and strength has been developed in England. The metal has practically the same specific gravity as aluminum, its principal base, is white and takes a high polish. While extremely malleable it does not become brittle by pounding, but instead increases in hardness. A sheet of the alloy was towed for almost six months in the ocean by a steamer operating between England and New Zealand, and at the end of that time was found to be as bright as when first put in the water, it is asserted. Promoters of the alloy contend that it is particularly adapted for internal combustion engines, marine fittings, medical apparatus, and similar uses. It has a tensile strength of 13 tons to the square inch.

PRESERVATION OF THE CAR

To remove grease or oil marks from a French gray or light-colored car do not use paraffin or gasoline, but procure a piece of castile soap, a sponge and a bucket of cold water. Lather the sponge well with the soap and wash off the marks of oil or grease. Thoroughly rinse all the soap off, and then polish with a leather in the usual way. The other hint, which also deals with the treatment of panel surfaces, is for the removal of tar spots. This is effected by smothering the tar with butter in the evening, and leaving it on until next day. Then place a little paraffin in a pail of water before sponging off, and finally finish with a soft bit of linen or silk and a little linseed oil, as the latter freshens dull places where the tar has been.

THE TENDENCIES IN BODY DESIGN*

By Hinsdale Smith

Body design is a matter of both utility and appearance. I believe that the present tendencies are toward the greatest efficiency and that the automobile body of the future will be evolved along this line. In seating arrangements we have observed a tendency toward the sedan style in touring cars, using one very wide door on each side in the rear of the front seats; the front seats have a passageway between them or one of them being made to fold up to the side of the body. This is a practical arrangement and in the case of five-passenger cars a very useful design. The doors should be at least 25 inches wide. The body should be made for somewhat less money than when four doors are employed. In small bodies particularly, with the four-door arrangement the doors have to be made too narrow where a deep cowl is employed. With the two-door body the cowl may be made very deep, giving plenty of room for a large gasoline tank where this is desired. The door is also placed forward of the rear fenders, making it much easier to enter when the top is raised. The same idea might be carried out with seven-passenger bodies, but I believe its usefulness is confined to the smaller type.

There are numerous instances of bodies having a tire-compartment in the rear; the tires being placed in the body by removing a panel in the back of the rear seat, in which case the tire is carried in a vertical position. In several recent foreign designs the tires are carried horizontally on the floor of the car, lying under the rear seat, occupying the lower portion of the extended back end of the body. In these cases the rear end of the body is of the streamline form. On cars having the gasoline tank at the rear it is not easy to conceal the tires in the back of the body. The use of the dash tank where it can be arranged to be of sufficient capacity is of value in this connection.

There is an increasing tendency abroad to devise some means of concealing the top in the body when it is not in use. Numerous new designs are appearing and the development should be watched with considerable interest. Those I have so far inspected are rather crude when the top is in use, there being a very unsightly opening left at the back of the rear seat. Several designs have appeared recently in which the body is fitted with removable lids which are opened when the top is being raised and closed when it is up. These are fairly successful on narrow bodies but not satisfactory on bodies having room for three on the rear seat.

It is a matter of common knowledge that nearly all new body styles originate in Europe. Why this should be can be understood clearly when it is considered that a customer there wishing a new car buys the chassis separately, which he takes to the body builder who builds specially to individual requirements. [Just as is done here by the same class of client who is willing to pay for distinction and individuality of design, rather than the kinds that are turned out of a mold.—Ed. Hub.] In this way there is an endless chance for experiment; each body incorporating new ideas and improvements. A single body builder has the opportunity of building hundreds of new designs in a year, whereas in this country a manufacturer builds thousands of only two or three designs. For this reason it is most necessary to watch the body work being done abroad. Many new designs appearing crude to use at present will in the course of a year or so be perfected and modified to give pleasing and practical results. It must be borne in mind that not all designs which look well on foreign chassis appear equally well on ours, as the foreign chassis are built lower and have better body space. In the past the American engineer has been prone to skimp the space behind the dashboard in order that his engine be not crowded, forgetting that he is building

a carriage to transport people over the highways rather than an interesting piece of mechanism.

I believe that within a season or two a practical design for folding the top into the body will appear; the top being entirely well out of sight when down. The design should be so worked out that there will be no necessity for removing any straps or slip cover. It should also permit of the top being much more quickly brought into place; with the present arrangements it takes several minutes to uncover and unstrap the top.

While not strictly connected with body design, there is a very marked tendency abroad to increase the height of the hood, due undoubtedly to the use of long-stroke engines. The hoods have a circular-shaped top, getting away from the old Mercedes type; being also much wider at the rear, making it very easy to design a streamline body merging very gradually and in some cases imperceptibly into the hood. The new radiators are also rounded off so that all angularity is obliterated. The top edges of the body, instead of being straight and finished with a bead, are rounded over, the upholstery coming flush with the top edge and not being overstuffed. This makes a very pleasing appearance, very much in keeping with the streamline design. The tendency is to get rid of all angles and round all corners, giving the whole car as much of the stream line as possible. This is a logical development and will eventually be the generally accepted design. The tires, top and all other accessories will also be covered within the body. This will not be accomplished in one season but be a gradual development.

My remarks apply not only to touring cars but largely to limousines, as to which there is at present a divergence of opinion as to what is really the best type. The streamline type of body originated in Germany and was not taken up widely in France until recently. The rounded type of limousine is an outgrowth of the streamline touring body. The use of the rounded-roof type of limousine has grown considerably within the last year. It is popular over a large part of this country, but we find that New York City patrons prefer the flat or old-style roof dipping at the front toward the dashboard. This is undoubtedly due to the fact that so many French bodies are used in New York, the French designers not having adopted the German style. To take up the more specific points in limousine design, there are very few of the double-compartment type now being made. Frameless glass is used universally. There is a strong tendency to use more hard wood in the interior trimming. Very little broad lace is used in the trimming. There is a tendency to conceal the toilette cases by some makers, but this is a doubtful improvement.

There is undoubtedly a growing demand for closed cars. The public has accepted the automobile as a permanent institution and the owner of a car is not now satisfied to put his machine away for the winter but expects to use it throughout the year. Naturally the man who drives his own car is as desirous of protection as those who ride in limousines. It was for this class of owner that we developed our convertible body. Strange as it may seem, 90 per cent. of our customers owned limousine cars; having been used to the comfort of closed bodies they desire the same protection when touring on cold nights or rainy days. We believe that eventually all touring cars will be supplied with some form of convertible body. The owner will then be equipped for all-the-year use of his car and can adapt it to the weather or his various moods.

To sum up, the present tendencies in body design are toward the streamline type, hood and cowl merging into the body, rear extended to enclose top and extra tires and an outline to minimize wind resistance, all edges rounded off, five-passenger bodies with two doors only, and convertible top to give complete glass protection when needed. The enlarged cowl will provide plenty of room for the gasoline tank, convex fenders and probably all lamps set in and made flush with the guards, radiators or body. The headlights will be provided with dimmers or extra bulbs of small power. The whole tendency of

*Paper read before Indiana Section S. A. E.

logical design is to smooth off the body in every way possible, removing all projections, greatly facilitating cleaning, which is really a great advantage. The owner of the future will demand a car that will be comfortable to ride in at all seasons, that can be changed from open to closed with the minimum of time and trouble and in which all accessories and spare parts will be covered and protected and easily kept clean.

Bodies will look odd to us as we experience the evolution; first, the concealment of the extra tires, then perhaps the elimination of the usual folded top, then non-projecting lamps, etc. Finally we will wonder why we formerly covered a car with so many trappings.

WHITE METAL BEARINGS IN A MOULD

A correspondent of Commercial Motor writes that for relining gun metal brasses with white metal he has found a way which he pronounces good, and he illustrates and describes it as follows: I first secure a wood box and fill it with plaster of Paris mixed to the consistency of a thick paste, and then embed the bearings in the plaster, as shown in the first sketch, where a double-flange and a single-flange bearing can be seen in position. A piece of steel is then turned to the exact size of the shaft, after the latter has been trued up. This mandrel is

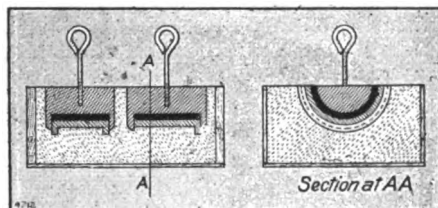

The box is filled with plaster of Paris.

provided with flanges, which fit over the ends of the brasses and prevent the white metal from leaking out.

The mandrel for each brass is pushed down into the necessary position in the plaster, and the latter allowed to solidify. It may be more convenient to cut the mandrel in halves and fit each half with a handle made of a screwed piece of wire for ease in withdrawing. If radii are required at the ends of the brasses, these can be turned on the mandrel while making same.

The metal can now be poured into each brass from the top, as will be seen from the second diagram, until it is up to the level of the top of the brass. When it is sufficiently cool, the mandrel can be withdrawn by means of the handle, leaving a perfect relined bearing provided with the correct radii where required.

This system is applicable to both new and old brasses, and removes all the difficulty which is sometimes experienced with the oil holes which are provided in them. These usually have to be stopped up with fire clay or some other material, which often causes spitting of the metal and other troubles.

When once the mould is made, it can be taken care of and used as many times as is required, providing that similar bearings are to be relined. I would draw attention to the fact that it is necessary to clean the brasses well, and to re-tin them before running the metal in. It may also be found advisable to warm them up slightly.

CORD TIRES IN RACES

The cord tire played a greater part in the speedway race than was expected by many. It was the first occasion in which the cord tire had a test in speedway races, and these tires, which cost considerably more than the woven-fabric ones, promise to receive much greater attention.

To the driver the cord tire is a safer racing tire than the fabric one because it rarely blows out, there being a colored

strip in the tread which shows itself and gives a warning to the driver that there remains but so many additional miles of use. As a result there were fewer blowouts than in previous races, although the cord tire was not entirely immune, at least some makes of it were not. There were cord tires made in France, in England, and by a couple of the tire companies in America. Of these the French makes seemed to give the greatest trouble.

The cord tires used were generally of larger diameter than fabric ones, rears of 6 inches diameter, and carrying but 70 pounds pressure. There was one make of American tire using but 40 pounds pressure. These lower pressures in themselves are desirable factors and that the large-diameter tire of cord construction does not reduce speed but actually adds to it, is one of the foremost reasons why the cord tire will become more prominent within the next year.

Within the past six months the cord tire has demonstrated its value in fuel economy contests, several concerns proving that it is possible to get considerably greater mileage per gallon of fuel with cord tires than with fabric types. The economy of the cord tire has also been demonstrated in the use of electric vehicles, it being possible to measure with electric instruments the economy in current when using the cord tire as compared with using the fabric tire. As economy is becoming more and more an important factor with the car buyer it is but natural to look for an increase in use of the cord tire in spite of its greater original cost. Up to the present manufacturing difficulties have stood prominently in the path of cord tire development, but these are being eliminated and history will very nearly record the fact that 1914 will be the first really good year for cord tires in America.

WAGON MANUFACTORY MOVES TO KNOXVILLE

The firm of H. L. Witt & Sons, of Morristown, wagon builders, will move their factory to Knoxville, Tenn. H. L. Witt & Sons have quite a reputation for building circus wagons, and this feature of the business is specialized. They now have contracts to remodel all the wagons of the K. G. Barkoot carnival this winter, as well as to build a number of new ones for him, and for this reason they will locate temporarily in the stock barns at Chilowee park, on account of the large amount of space available for storing the wagons when completed, as the carnival will winter in Knoxville. Contracts have also been signed by them to build a number of wagons for Sun Brothers' circus.

DIRECTION OF THE NAP

It is asserted by the carriage trimmer that the various parts of the trimming should be so made up that they brush to the front, the argument being that it is easier to clean up an interior made up in this way. One trimmer holds a different view. He thinks it better to have a head lining with the nap of the cloth running from the head to the back, as by this means less dust is taken up by the cloth, as the draught flowing into the body would be in the direction of the nap and not against it.

NEW PLANT FOR BARBOURVILLE, KY.

Buggy, wagon and automobile parts will be manufactured on a large scale at the wood working plant which T. W. Minton & Son are to establish in Barbourville, Ky. It is given out that the plant will cover two acres and employ 40 men at the outset. The Business Men's League has given the site and arranged for a railroad switch. The venture is expected to furnish a large market for the hickory timber which is cut in the district around Barbourville.

WOOD WHEELS ON HEAVY VEHICLES*

By Clarence B. Hayes

The rapid growth in the last few years of the manufacture and use of heavy-duty commercial vehicles has given rise to the establishment of a new branch of the wheel industry, that of the so-called truck wheel. This type of wheel stands quite apart from that designed for the pleasure car, owing to the very different conditions it is called upon to meet, the different sorts of demand made on it in service. In the one case we have comparatively light loads, driven at high speed, demanding a light, elastic member capable of quick recovery from road shock, the principal strain being due to side thrust, the result of skidding, curb impact and similar treatment, not encountered to so great a degree by the slower-moving motor truck. In the other case, we find extremely heavy loads driven at relatively low speed, stability and durability being first considerations.

As the advent of the automobile wheel was followed by abandonment of buggy-wheel methods, as unsuited to the needs, with the coming of the truck wheel the wheel maker was confronted with a new problem and forced to work along different lines to attain the desired result—a correctly designed, well-proportioned product to be relied upon. Although still seizing every opportunity for improvement, he has already met with success, and in the present wood artillery wheel has a type peculiarly fitted to stand up under the severe usage to be expected in its work on a heavy vehicle. The cost is low as compared with steel or malleable iron wheels, while light weight and ability to absorb shock make for longer tire life than in the case of heavier, more rigid metal wheels, which throw the larger portion of the road shocks upon the axle and bearings. The theory has been advanced that the quick radiation of heat by the metal wheel means lower time temperature with a correspondingly longer life. We are rather skeptical on this point, for the heat is generated at the point of contact of tire and road surface, and it seems likely that most of this heat is transmitted to the surrounding air rather than up through the rubber tire and steel band and thence to the wheel proper.

When the first truck wheels were built some trouble was experienced because of the wheels getting out-of-round and out-of-true, causing more or less attention to be paid to the question of metal wheels, which undoubtedly can be made without much difficulty in this direction. This trouble has now become practically a thing of the past, however, and the present-day wood wheel, made according to modern methods and by specially designed machinery, is not only true and round at the start but remains so.

There are two dominant qualities in the wood wheel that make it stand out prominently—resilient, cushioning resistance against the evil effects of American road conditions, and remarkable ability to withstand the severe climatic conditions here, with extreme temperature change. Wood is not susceptible to temperature change to any extent, the only factor entering being moisture; admittedly wood will deform if allowed to absorb moisture. By the use of bone-dry stock, the pores being filled with lead or oil primer, and several coats of paint being added, ample protection is afforded against change of shape.

Many attempts have been made to design some substitute for the wood wheel that will absorb vibration, the great enemy of longevity of a motor truck. The results to date have been unsatisfactory, most of the substitutes being costly, of prohibitive weight, and having little or no provision for taking up lateral strains, which, as a rule, either cause partial failure of some part, or leave a permanent set which becomes greater with each successive shock. The wood wheel receives the side thrusts, yields to them gently with a minimum of shock and

promptly springs back to its original position after the strain is removed.

Some time ago some tests were made for us at the University of Michigan laboratories on both pleasure car and commercial car wood wheels. A brief summary of the results in one or two typical cases may prove of interest.

Size of Wheel	Spoke Flange	Type of Wheel	Dishing Load	Direct Load
34 x 3 S	2 x 8 $\frac{3}{4}$ in.	1-ton front	16,100 lbs.	40,800 lbs.
36 x 4 D	3 x 12 $\frac{1}{2}$ in.	3-ton rear	30,100 lbs.	114,000 lbs.
40 x 5 D	3 $\frac{1}{2}$ x 13 $\frac{3}{4}$ in.	5-ton rear	48,300 lbs.	140,000 lbs.

One 36 x 4 in. dual wheel tested to the limit of the dishing load, and then for direct loading, stood up to 107,000 pounds, or within 94 per cent. of the maximum allowance load. A 36 x 5 in. dual wheel, tested the same way, stood up to 133,000 pounds, or within 95 per cent. of the maximum. With the 36 x 4 in. 3-ton rear dual wheel a record was made of the deflection up to 12,000 pounds, then a little more rapidly until the maximum point of 30,100 pounds was reached. Loaded at 23,000 pounds and released, the wheel regained its original position and even from the maximum or breaking point recovered to a remarkable degree, with 1/10 in. permanent deflection. The wheels had no initial dish, as is provided in the case of pleasure car wheels for added protection against pulling the heart out of the spider. A glance at the tests is sufficient to show that there is little question of the wood wheel being able to stand up under the heavy loading put on it in practice. Failures are very rare, and in practically every case can be traced to either the use of a wheel on a heavier car than that for which it was designed, or the use of a brashy timber which under ordinary circumstances would never escape the eyes of the stock grader.

The wheel life would be lengthened materially if more attention were paid to the condition of the tires and they were replaced after having served their time. The old-style truck wheel, intended to serve without a rubber cushion, was assembled with a heavy band of steel $\frac{3}{4}$ in. thick. The present truck wheel, to be used with a solid rubber tire, is equipped with a relatively light band, $\frac{1}{4}$ in. thick on the smaller single sizes, $\frac{3}{8}$ in. on the larger single and all dual sizes. When the truck owner permits his tires to become worn to a thin ribbon, unable longer to do their work, and forces the wheel to stand treatment for which they were never intended, he is simply throwing away so many years of good wheel life unnecessarily.

For years the wheel maker followed individual designs submitted by customers, in a good many cases against his better judgment, but in the past year or so there has been a growing tendency to defer to the opinion of the wheelwright, to leave the design, in part at least, to the man whose experience cannot but prove a valuable asset to the car builder.

The time may come when the wood wheel will be replaced on heavy vehicles by some other type; by some substitute which will either fulfill the required conditions better at the same cost, or equally well at a lower cost. For the present, at least, there seems to be a lack of such a substitute.

PART PLAYED BY THE MOTORCAR IN MOBILIZATION OF FRENCH ARMY

At 4:30 o'clock on the afternoon of Saturday, August 1, France issued a general mobilization order, writes the French correspondent of The Motor (Eng.). Those posters, which, doubtless, had been printed weeks in advance, and only needed the insertion of the date, were the intimation that, for the first time in 43 years, every able-bodied man under the age of 48 must be under the colors within a period varying from five hours to five days. I was in front of the Ministry of War on the Boulevard St. Germain, about 4 o'clock, when I was given the assurance by an official that the order might be expected out within an hour. I drove up to the Avenue de la Grande Armee, in order to buy a few necessary parts in provision of a long motor campaign, when one of the salesmen re-

*Paper read at Detroit Section S. A. E. meeting.

marked, "It has come at last. He directed my attention through the window to one of the Bon Marche motor delivery vans, which was being driven by a reservist, with half a dozen soldiers behind him.

In Paris at 7 o'clock the same evening, 1,000 motor omnibuses had vanished from the streets, half the taxicabs had disappeared, and few of the tramways were running.

French military experts were not slow to realize the fact that motor vehicles would play a dominating part in a great clash of arms. Thus, they have kept themselves abreast of all developments in the motor field, and, in many cases, have led and encouraged that development. One's thoughts naturally turn to the use of motor lorries for food and ammunition transportation. But this is far from being the extent of the application of motors to warfare. Touring cars are required, for officers no longer ride about on prancing horses, but scurry around, from point to point, over well-made roads, keeping in contact with troops spread over immense areas. For such work they do not maintain cars during peace periods, for they know that at a moment's notice they can call on owners' and manufacturers' fast touring cars, and that they can enlist as drivers the crack racing men of the country, men who can drive at hair-raising speeds for hour upon hour, who know every highway and byway throughout the length and breadth of the land, and who have previously undergone a period of two or three years military training.

As a specific instance, a few months ago I was, in a journalistic capacity, admitted to the interior of one of the great forts and military storehouses just to the east of Paris. In one portion of the immense grounds—for the place is practically a town in itself—I came upon the race drivers, Boillot and Rigal, standing by the side of powerful touring cars. They had been called up for that periodic inspection which would insure them being ready if the call came for active service. Curiously enough, I saw those same cars and the same drivers standing outside the Ministry of War while the mobilization orders were being placarded on the city walls. Boillot was private chauffeur to General Joffre; Rigal was carrying one of the headquarters staff. At the present moment they are both at the front.

Among the young motorists this is highly appreciative work. It offers endless possibilities of adventure; hard driving on military-guarded roads over which they are complete masters, where they can commandeer gasoline, oil, tires, etc.; all-night trips under the glare of searchlights, or wild runs in the inky blackness, where the use of lights might dangerously betray their presence; daring incursions into the enemy's country, with the knowledge that they may be surprised at any corner, that their escape may depend entirely on superior speed, greater skill in driving, or a better knowledge of the roads. With telegraph wires down, there are urgent messages to be carried to the commanders of different bodies of troops, probably through country into which the enemy's outposts have adventured.

Hundreds of private-car owners are enrolled for military service with their machines. The order of mobilization to them means that they must leave on the first, second, third or fourth day of mobilization, as the case may be, for the place indicated on the military pass-book, and that they must take their cars with them. These men have been enrolled probably for a number of years, and their cars have been examined at frequent intervals in order to ensure that they are in fit condition to take the road.

All Cars Eligible

There are 100,000 privately-owned cars in France, and not all their owners are enrolled as reservists to serve with their machines. Yet all the cars are eligible for military service, and can be seized by the authorities at a moment's notice. This is not an emergency scheme put into force at the outbreak of the war, but is an arrangement developed for years. Every owner, in addition to the police declaration of his car, must make to the local authorities a military declaration, to be

renewed every year. This declaration, which is carefully controlled, states the horsepower of the car, the number of seats, the make of magneto, the make and age of the car, the make and size of the tires, and the name of the driver if he is eligible for military service. The scheme applies to all cars, whether owned by natives or foreigners. When cars are required, the local mayor is ordered to provide a certain number of a certain type. He examines his military lists, notifies the owners that their cars are required, or has them taken away by his subordinates. No car is paid for in cash, but at the moment of seizure a credit note on the Treasury, payable after the war, is handed to the owner. Value is determined by the authorities according to a predetermined scale, which takes into consideration age, make, and general condition of the car. The owner has no right to protest against the value fixed by the army authorities. Cars seized in this way are put into the hands of troopers or reservists having had driving experience.

ADJUSTING SLACK OF A BELT

The slack of a belt running straight between two pulleys can be easily taken up by means of the adjuster shown. The

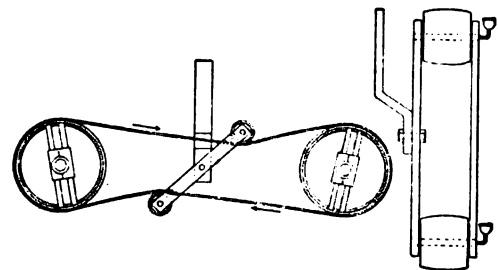

The Slack in the Belt Is Taken Up Evenly from Both Sides

adjuster consists of a frame, carrying a small pulley at each end, supported loosely at its center. The pull of the belt will keep it taut.

ENAMEL LEATHER MEN MEET

The annual meeting of the members of the Patent and Enamelled Leather Manufacturers' Association will be held on the Million Dollar Pier, Atlantic City, on Thursday, October 1, immediately following the adjournment of the meeting by the accessory members of the Carriage Builders' National Association. At this meeting the leather men will elect officers, directors and appoint committees for the ensuing year.

MOLINE POLE & SHAFT CO. QUILTS BUSINESS

Dissolution of the Moline Pole & Shaft Co., which was decided upon at a meeting of the stockholders August 20, is now complete. The charter has been surrendered to the state of West Virginia, where the concern was incorporated, and all the machinery and other equipment of the plant has been sold to out-of-town concerns also engaged in pole and shaft manufacture.

GENUINE LEATHER

The Howell-Hinchman Co. tell you to "insist on having genuine leather." We are of the opinion there are not two choices when it is possible to have real leather for certain purposes. Then it comes to be a question of quality, etc. We know that in this respect the product of the tanneries of the above company at Middletown, N. Y., are producers of very high quality leather, tanned by old and reliable processes that mean durability and strength.

BOXING WHEELS

In the good old days of the tar axle it was not very difficult to prepare, by hand, the hub for receiving the boxes and to set them securely by means of wooden wedges. This is true only because the wheel boxes were mere short, thick, cast-iron bands set into the ends of the hub, which required the removal of only a small amount of material from the interior of the hub, and these boxes could easily be set to make the wheel run true by driving wedges around them into the hub. Upon the introduction of the thimble skein this method never proved quite satisfactory.

Except a small portion immediately under the spokes, the thimble (usually called the wheel box at this time) should have a bearing—a driving fit—throughout the hub. Unfortunately, it is almost impossible to obtain this condition setting the boxes with the usual hand tools employed in the method referred to. Plugging up the ends of the hub, finding the center, measuring the box, laying off with the dividers, cutting the recess for the shoulder of the box and removing the surplus material with the gouge, all go to make this a tedious operation; but the worst is yet to come. Though the mechanic be accurate and painstaking enough to remove the proper amount of material (making the proper recess under the spokes that will allow a nice driving fit), the box will most probably not be true with the wheel when it is driven or pressed into the hub. Of course there are many good mechanics who can remove the box, take out a little more material, replace the box and wedg it over until it is almost exactly true with the wheel. This might appear very easy to the uninitiated; but the writer has noticed that the workman usually wears a broad smile when the box shows true with the wheel.

It is really quite an art to wedge the box in properly; rather, to wedge the box in the best manner, because the hub should really be prepared to receive the box in a way that would not require any wedges. For when the box requires to be wedged in at one side, then upon that side it has a bearing only at the extreme ends; which condition is not at all desirable, as constant heavy loads will crush this small bearing surface and, if the box does not become loose enough to fall out of the hub, the lubricant may enter between the box and hub (soaking into the ends of the spokes), which condition quickly ends the usefulness of the wheel.

The writer has seen several hand-made wagons that stood up under hard service for many years. However, this is not considered as proof of the superiority of this method, but rather a tribute of honor to the mechanic whose skill made it possible. While no doubt exists that there are many mechanics whose ideals are so high they will always do a pretty good job, regardless of any handicap, nothing can refute the fact that the best way to provide for mechanical difficulties is to fix it so the difficulty cannot happen.

The machine design shown here is not the first worked out by a large number. The principal idea in the study of a new design for a hub boring machine was to produce a machine which would employ the box to be fitted as the guide for the boring tool, and to have the tool revolve; the wheel being clamped solidly to a stationary support. In developing this idea the parts supporting the revolving tool became so complicated that the modification shown here is considered more practical.

Combination tools and machines are not usually satisfactory. However, combinations of machines that are not used regularly may be both efficient and economical; especially in the repair shop. The machine shown in the figure may be a combined drum and disc sander, face-plate lathe and hub-boring machine. Where the shop already possesses a good sized face-plate lathe or disc sander, the hub-boring part may be attached.

The sander drum may be of any form; the one shown at 26

may be used as a table sander by attaching the table 25, which may be supported and adjusted by the four wrought iron pipes, 27. Of course, it is evident that to convert the machine into a face-plate lathe it is only necessary to remove the special wheel chuck, 18, and screw the face plate upon the spindle. The lathe rest necessary to use in this connection may also be used with a tool for truing the tread and face of the wheel rim. The machine may be converted into a disc sander by screwing the disc carrying the abrading material upon the spindle, and providing a suitable table secured to and supported by the main frame.

To use as a boring machine, the wheel is clamped upon the wheel chuck, 18, by three or more screw hooks (shown at 20), the wheel being centered by the arms, 19, each of which have V-shaped ends for clamping the hub. The arms, 19, are actuated by a right and left hand screw which is retained in the proper position by the means shown at its middle and has two square ends, 22, provided for the use of a chuck wrench. The two parts, 23, swivel to allow the arms, 19, to be adjusted for small and large hubs. The column, 12, supports the other parts of the boring machine.

The box, 6, which is to be fitted, is secured by the two cones, 7 and 8, as shown, which hold the axis of the box always parallel to the spindle, 3-4. The part, 10, which carries the cones, 7 and 8, may be raised or lowered by the screw, 9. The shank,

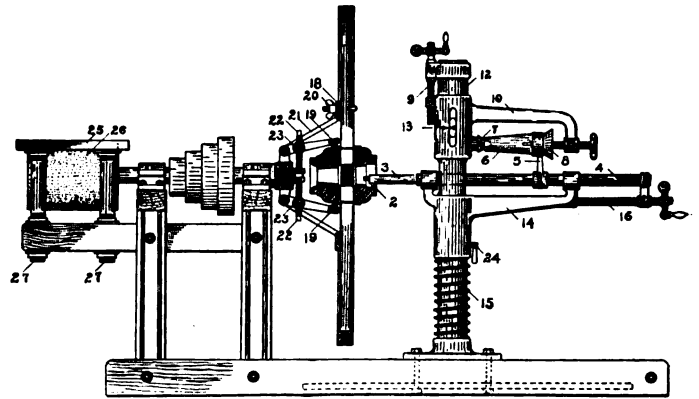

A combined drum and disc-sander, face-plate lathe and hub-boring machine for the wagon shop

3. spindle, 4, and traveling screw, 16, are carried by bracket, 14; the spring, 15, having sufficient compression to support the weight of these parts and hold the finger, 5, against the wheel box, 6.

The machine only needs one adjustment; that being when it is made. This may be done as follows: Take any wheel box, 6, that is in fair condition, and secure it firmly between the smoothly finished cones, 7 and 8; lower the part, 10, by means of the screw, 9, until the arrow, 13, corresponds with the other arrow which marks the lower limit of vertical movement. The cutter, 2, may next be set with just the desired amount extending outside of shank, 3. A thin metal or any suitable gauge should be provided for setting this cutter, so that it may always be set exactly the same. Now a hub is secured by the chuck, 18, and the lowest point of cutter marked upon it, then turning the hub through one half a revolution, again mark the position of the lowest edge of the cutter. One-half of the difference of the distance between these two marks and the diameter of the box used will be roughly the amount to remove from the guide finger, 5. Care should be taken not to remove too much from the guide finger, 5. The adjustment may be finished by using the calipers to obtain the exact size in the first bore, and filing off the end of 5 until 13 corresponds with the other arrow. After adjustment has been made, the end of guide, 5, should be hardened.—A. C. Gough, M.E., in American Blacksmith.

CYCLECAR VS. LIGHT CAR

There is a very much growing idea that the cyclecar movement is going to emerge as a light car enthusiasm, and that the cyclecar, so called, will thereby be a thing of the past.

This feeling is not without foundation, for those in touch with cyclecar developments see a great change coming over the whole movement, a reaction from the first burst of enthusiasm, which was predicted long before it came.

The idea of the cyclecar movement was to produce the cheapest possible motor vehicle, and it has been superseded because the cyclecar in its first forms has proved itself worthy of better constructions than had been given it at the start and because mechanisms of few parts have not proved as reliable nor as cheap to build and buy as more standard and more complicated parts.

Another point having a decided bearing has been the slowness with which the public accepted the cyclecar idea to the extent of actual buying. They enthused, they gathered in crowds to watch, they expressed enthusiasm, and they predicted wonderful things, but those who bought went to cars of automobile standards, and of those who enthused on cyclecars the most had little money to buy.

As a result, makers are taking to four-cylinder water-cooled motors, shaft drive and gearsets and live axle constructions. **They are entering the light car field**, with its sociable seating and its higher first cost and the public thinks the cyclecar movement has perhaps failed.

As a matter of fact the cyclecar movement has hardly started. Makers started to experiment with cyclecars and yet could not forget the automobile. They added this and they added that, and when all was done the cars weighed 800 pounds instead of the 450 they started out to reach, and this weight was to be driven by a motorcycle motor. The wonder was that motorcycle motors did handle this weight and are handling it today. The best of these V-motored cars are running satisfactorily, but only on those cars where there has been real workmanship. Some of them were so cheaply built that they did not last at all. These are the ones which have harmed the cyclecar movement and have set it back.

The cars produced were to sell at under \$400, and did. They did not sell in the quantities expected, however, as when this price was paid the buyer wanted a motor car, and as light cars at this figure were produced at about the same time, the public bought the light car first. The cyclecar is still in embryo.

A great reason for the change to four-cylinder plants was that the V motors available were too costly to build to enable their makers to make a price on them consistent with the performance. They were fast but they would not run slow; they had low fuel consumption and great noise, and the public was afraid of air cooling. All of this hindered sales, while in fact the motors were doing wonderful work. Only recently the writer drove a V-motor cyclecar on a straight stretch of concrete road near Detroit in a race with a car which was an exact duplicate except that it was fitted with a four-cylinder, much larger motor, and beat it easily. On a hill or in sand, however, the V motor would have been the loser, as it was pulling 950 pounds.

There is but one field for the cyclecar, and that is in the simple light class. The car should not weigh over 500 pounds, and should have a low gear ratio to the motor. This motor can be back of the rear seat and connected to the solid axle by a chain and motorcycle clutch on the motor shaft, without gearset. If there is a gearset it must be friction or its equivalent, light and very cheap; but exceptionally well built. The body should be very light, and be a single seater with perhaps a spare folding seat for a passenger when wanted. All of this must be on the basis of ultra simplicity and the selling cost must not be over \$275, preferably to be paid on the installment

plan. It would then appeal to a class between the motorcycle and light car and have a niche to fill.

To build this car certain things must be done, however. In the first place motors must be simplified. A V-type motor should be simpler than a four-cylinder, but at present they have more complication instead of less, due to the built-up crankshaft and the crankcase constructions. If the extreme of simplicity is sought the two-cycle motor should be thought of in the single-cylinder or two-cylinder type, as this is the cheapest of all to build and with friction drive should be flexible enough for a \$250 car.

Simpler types of car are possible, and probable, and will have as wide a field of sale as the motorcycle and probably much wider.—W. B. Stout, in *Automobile*.

LOCKING BAILS VERTICALLY ON A GLUE POT

A very effective method of keeping the bails of the glue pot in an upright position is to bend the one on the inner glue receptacle square at the upper part and make a slight bend in

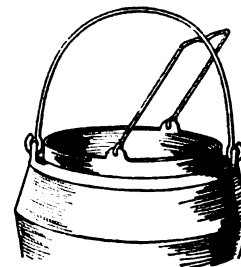

the straight length to catch on the bail of the outer water can, as shown. This will prevent them both from falling down and from getting too hot to handle.

LINOLEUM GLUEING PRESS

The linoleum on the running boards may be either tacked down or held by the metal angle strips which surround the board, says *Automobile and Carriage Builders' Journal*. As first precaution against warping, the boards are not made in one piece, but from two or three pieces which are tongued and grooved together. These boards are then impregnated with creosote, so that they are absolutely impervious to water. As a third precaution, these boards are mounted on four channels with steel step hangers, so that if considerable water is applied to any one portion of them it will keep them from bending. Then the boards are covered with linoleum, which is not tacked down, but glued on to these boards with a waterproof glue. While this glue is setting the boards are placed in a big press, so as to ensure a uniform appearance and perfect adhesion of the linoleum.

NOVEL TAIL LAMP

A tail lamp which cannot go out has been sought for a long time. To obtain this, all that is necessary is a metal tube, a small adjustable mirror, and a small lamp of the usual bulbous pattern with red and white glasses. The tube, which must be perfectly straight, and of sufficient length to extend from front to rear of car, is fixed underneath with the adjustable mirror in such a position that the head or side lamps shine upon it. The front lamp will project a strong beam of light into the tail lamp which is fitted to the rear end of tube, and which must be well plated inside, care being taken that the light does not strike directly on the ruby glass but on a plated part. This will cause the lamp to glow very brightly.

Iron shavings in a wiry, fibrous mass are mixed with concrete and sand in France and used for surfacing roads.

Paint Shop

ENAMEL PAINTS

The manufacture of enamel paints has grown to very large proportions during the past few years. Enamel paints are paints which when applied to the surface of objects, leave behind a hard and very lustrous coating, very different in appearance to the much duller coat left by an ordinary paint, and therefore have a greater decorative effect.

A great variety of enamel paints can be made. They may be made so as to be cheap or dear, quick or slow drying, according to circumstances; but, however they may be made, they must possess one characteristic, viz., that of drying with a lustre and with a hard surface.

This condition can only be attained by using some resin, like copal, kauri, resin, etc., such bodies being the only ones which possess sufficient lustre and are capable of ready conversion into a soluble or liquid form, so that they can be spread by a brush over the surface of the object to be painted. The nature of the solvents which are used to dissolve these resins will depend upon the nature of the resin used, and also upon the character of the paint which is to be made. If it is to be a quick drier, some volatile solvent must be used; while if a slow-drying enamel is wanted, a different kind of solvent is used. Simply to dissolve the resin in the solvent, is however, not sufficient, for then only a varnish is obtained, whereas a paint is required; the difference between the two kinds of materials being, that although both leave a lustrous surface, a varnish dries with a transparent coat, underneath which the real surface of the object is visible, while a paint dries with an opaque coat, which hides the real surface of the object. To enable a paint then to do this, it must contain in addition to the resin and the solvent, an opaque substance, which is generally colored, which opaque body is known as the pigment. The pigment to which the color of the paint is due, must have one property, that of insolubility in the solvent which is used in making the paint, or otherwise it will lose its opacity, and nothing but a colored varnish will result. Hence it is that although a large number of colored bodies are known, yet, owing to their property of solubility in solvents, they cannot be used for coloring enamel paints.

The best pigments to use are the mineral colors, lamp or vegetable blacks for black enamels, using a little spirit soluble aniline black when enamels are made with methylated spirit, to give them a pleasant tone. Vermillion, red oxide, Indian red and Derby red make good red pigments, vermilion and Derby red having, however, this defect, that being heavy, they have an unfortunate tendency to settle to the bottom of the paint pot. Vermillionettes, royal reds, and other red pigments made from orange lead and the eosines, do not work very well in a methylated spirit paint, owing to the solubility of the coloring matter in the spirit; still they are largely used when a bright and cheap red color is wanted. Brunswick green, emerald green, and the green lakes made from the anilines, do very well for green enamels. The chromo yellows and oranges cannot be excelled for yellow and orange enamels. Brown enamels are best made from umber. White enamels are made with either lithopone, Orr's white, blanc fixe, gypsum, or zinc white. White lead is unsuitable.

When quick-drying enamel paints are required, then solvents of the nature of methylated spirit, resin spirit, shale naphtha, or turpentine must be used. Shale spirits and resin spirits make the cheapest paints, while those made from methylated spirit or turpentine are necessarily dearer.

When slow-drying enamels are wanted, then they must be made of the nature of an oil varnish with melted resins, linseed oil and turpentine, colored with the necessary pigment.

WALNUT OIL FOR PAINTS

This oil, which I obtained from the fully ripened nut of the *Juglans regia*, says a writer on the above subject, has so many excellent properties, especially for mixing artists' colors for fine art work, that I am surprised at the small amount of information available. Walnut oil is largely used for adulterating olive oil, and to compensate for its high iodine absorption it is mixed with pure lard oil olein, which also retards the thickening effect due to oxidation.

The value of this oil for outside work has been given me by a friend. Walnut oil is beyond the reach of the general painter, and I do not know that the pure oil is to be obtained as a commercial article, except on a small scale.

It was in examining the properties of this and other oils, used as adulterants of olive oil, that I was obliged to prepare them so as to be sure of getting them in a reliable condition as regards purity. The walnuts were harvested in the autumn, and kept in a dry airy room until the following March. The kernels had shrunk up and contracted a disagreeable acrid taste, so familiar with old olive oil in which this has been used as an adulterant. Most oxidized oils, especially cotton seed oil, reveal a similar acrid taste, but walnut oil has, in addition, an unmistakable increase in viscosity. The nuts were opened and the kernels thrown into warm water, so as to loosen the epidermis; they were then rubbed in a coarse towel, so as to blanch them. The decorticated nuts were wiped dry and rubbed to a smooth paste in a marble mortar.

The decorticated kernels gave a perfectly sweet, inodorous, and almost colorless, transparent, and perfectly elastic skin or film, which does not darken or crack easily by age. These are properties which, for fine painting, might be of great value in preserving the tinctorial purity and freshness of pigments.

Sulphur chloride gives a perfectly white product with the fresh oil, but when oxidized the product is very dark, almost black. The iodine absorption of the fresh oil thus obtained is very high, but falls rapidly by oxidation or blowing. A curious fact has been disclosed with reference to the oxidation of this and similar oils. If such an oil be mixed with lard oil, olive oil, or sperm oil, it thickens by oxidation, but is perfectly soluble. Commercial samples of linseed oil, when cold-drawn, have a much higher iodine absorption, probably due to the same cause.

THE PAINTER AND FAITH

It is questionable as to whether the painter ever thinks how much faith enters into his own particular field. At first thought the thing might be considered to have little or no practical bearing, but on giving it further consideration we believe the painter would see how important a matter it is. When paint or varnish, for instance, is ordered, has he not to rely to a great extent on faith in the manufacturer? The testing of all materials bought is, of course, an excellent plan, but we are afraid, apart from mere working tests, it is very often impracticable for any man in the ordinary way of business to do so, and, therefore, he must often of necessity rely on the honesty of the firms with which he deals. In these circumstances it is clear the buyer should choose to deal only with firms of repute,

or with firms whose goods he has already tested, and, therefore, feels confidence in. Concerning this matter, it would be advisable when opening with a new firm to have samples of materials sent before ordering, and then to order as per sample if they meet with approval. Generally, goods ordered in this way are satisfactory, but when not, there is a remedy—they should be returned at the manufacturers' expense. To do this, of course, means testing the sample, and also a little of the bulk material if ordered, and such, as already mentioned, is sometimes impracticable, but being so mainly in the busy season, we would advise that all such dealings are begun at a slack time.

SWAN PROCESS OF PREPARING GOLD LEAF

This consists of depositing a thin coating of gold upon a copper base, and then dissolving the base by submission to perchloride of iron. The leaf may by this means be made of the thickness of 1/4,000,000ths of an inch. The copper being ultimately recoverable, the process is reported to be in every way economical, apart from the saving of 80 per cent. of the precious metal by reduction of weight in leaf.

WHY AXLES BREAK

The foreign point of view on this interesting subject is approached by a writer with explanations and illustration, which readers may find interesting.

The accompanying illustrations show the difference in the forgings of axles for different vehicles in two distinct shops.

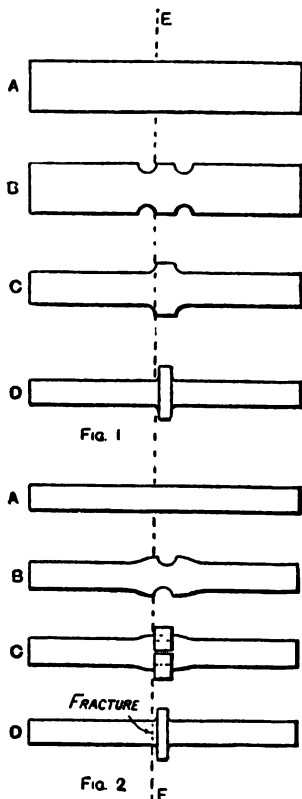

Fig. 1 shows how it would be forged in a large shop where steam hammers and other appliances are used, making it quite easy to make, and when finished being quite solid and sound. Fig. 2, shows how in a small shop, where such axles for small vans, etc., are made; not exactly bad workmanship, as these smiths are victims of circumstances, and, as you know, better metal can be used in a large shop where the steam hammer does the hard work more so than a small shop, where the best metals are not always used. A man after he has been blowing the bellows to get forging hot, gets his rest by coning

and banging away on something that he does not want to be of the best quality.

Beginning with Fig. 1, this is as forged in a large shop, and Fig. 2 as in a small shop. In each case A, B, C. and D show the four stages in which it is made before the blacksmith has done his part, and following the line EF will show where this fracture is, and how it is caused. Fig. 1 begins with a large-size piece of metal, getting the collar solid by fullering on each side (see B), and then drawing the metal down under the steam hammer (see C). The rest is easy. Fig. 2, not having the means of drawing this metal down, a smaller piece has to be upset where the collar comes, and then fullered round (see B). More often square iron is used after being fullered round as shown at B, and in fullering a little too deep, gets below the actual size wanted when finished.

The best of workmen cannot guarantee this collar welded at the bottom C, and the consequence is, that when this collar is turned up, if not to the eye, it is there. A fracture caused by this collar at every blow works farther into the solid metal, and when turned up to clean the collar, part of the collar has become part of the spindle (see the dotted lines in D, Fig. 2), and this fracture, perhaps not seen by the eye, is at the most critical part of the axle. In fact, it becomes like a piece of metal nicked round by a chisel. The consequence is that if a sudden drop or wrench happens, off it comes; but if the right metal were used and forged as Fig. 1, a carriage, etc., could be dropped from a high distance or wrenched in any position, and would not break.

DO PIVOTED REAR SPRINGS AFFECT THE DRIVER'S COMFORT?

With the standard spring suspension and distribution of weights in an automobile, the front seats are most comfortable and the seats of honor in the rear receive the road shocks most directly. The cantilever suspension, says La Vie Automobile, remedies this somewhat illogical state of affairs. Without detracting much from the comfort of the front seats it lends to the rear ones a sweet indifference to jolts which was formerly very rarely experienced. The reason for supposing that the comfort of front seats may be affected by a cantilever spring whose free end points rearward—which is the kind referred to, and not the Bugatti type—lies in the downward thrust at the front shackle of such a spring which is applied every time the rear axle is jolted upwardly and which is transmitted through the frame to the front springs.

HOW THEY GROW

The editor of The Commercial Motor (Eng.) said at a banquet that the growth of use of commercial motors demanded an exhibition. There were only five vehicles of the kind in use at the end of the year 1898, compared with a total of 36,500 at the present time. Official statistics did not present a true state of affairs, because they frequently only took into account "heavy motor cars," whereas large numbers of delivery vans weighed below two tons unladen, but these were none the less strictly commercial vehicles.

WHAT MAKES A CAR?

How do men of judgment buy a car? They apply the one rule of business—the first rule of arithmetic—namely: A whole is equal to the sum of all its parts. They know that this rule can never be violated, that a car is no more, no less, than the sum of all its parts, no matter what its reputation or its price.

Let this rule govern your judgment. In judging each part, depend upon it, the builders of the highest priced cars would not have stopped making a part if specialists had not excelled them.

BUILDING MOTORS WHICH WILL MAKE CARS LOOK COMPLETE WITHOUT HOOD, AND WITH RATIONAL STEERING GEAR

Mr. Pepinster elaborates this idea in *Omnia* on the basis of a motor design originated and patented in 1907 by F. W. Hudlass, chief laboratory engineer for the Royal Automobile Club of Great Britain and Ireland. Mr. Hudlass wanted to produce a hermetically closed motor with all working parts contained within its housing, and the lines on which he conceived it are shown in illustration. As seven years ago nobody had yet thought of inclosed valve boxings and intake pipes, Mr. Pepinster accords to Mr. Hudlass the merits of a pioneer and continues commenting upon the Hudlass motor as follows:

Between the armored motor and the standard modern motor there are great differences in principle which indeed are not to the advantage of the modern motor. The valve boxes of which our designers are so proud are only an artificial addition to the motor body having for its object to conceal projecting organs and especially to prevent the clicking noises from these organs from reaching our delicate cars. The Hudlass design attains the same result but by means of a higher, more elegant and more advantageous conception. By raising the valve stems, tappets and springs to the rank of interior organs, Hudlass made sure of their lubrication and obviated the leakage of oil along the tappets. By making the joint between cylinders and crankcase come at the lower edge of the water jacket, he lightened the motor casting, as the lower half of the cylinders, acting now merely as guide for the piston, could be reduced in thickness and at all events was rid of its heavy lower flange. The general form of the motor was also improved, projections and corners disappearing while the possibility of making large apertures in the casing, as those marked DD in the illustration, served for better accessibility. The valve-actuating mechanism was also simplified, as in illustration.

This motor already seven years old does not seem antiquated. On the contrary, it corresponds to our actual wants and seems the logical improvement of the motor with valve boxings, which, on the other hand, seems to represent rather a transitory solution of a problem and a compromise between two principles. So much so, that we would not be surprised to see the Hudlass motor reappear one of these days.

This type of motor also makes excellent company for other inventions conceived in the same spirit. There is the web or table which unites the brackets of nearly all modern crank cases and is joined to the frame reaches or the false frame. This table, which in some cases serves as a continuous base plate for the motor, admits of dispensing with the drip pan; that unclean sister of the motor hood whose feeble merits as an organ of protection cannot make one forget its horrors.

There is, further, the armored magneto which is insensible to dust and defies the water hose. It might be made rain-proof as well. It has recently been completed by means of electric wire conduits which are not only insulated but watertight, and finally a spark plug has appeared whose porcelain is hermetically enwrapped within the insulation of the feed wire. It may thus be said that the ignition apparatus of our motors counts no longer on outside assistance for its defense.

What shall be said about the carbureter? Robust and not very sensitive, it fears mainly the dust and foreign particles and its means of defense consist in screens, which by the way are made of too small area and with too open meshes. Of late years the carbureter has manifested only one desire: that of hugging the motor. And it has come to the point, in this respect, that it is now usually attached directly to the induction pipe.

The organs of the motor as well as its accessories are thus by degrees becoming inclosed, the former within the motor itself and the latter in suitable coverings. Even the control organs show a tendency to seek shelter within the crankcase when there is an opportunity.

Hood Now Nearly Useless

This unanimity in the search for cover implies evidently that the hood, while seeming to protect the whole mechanism, in reality protects nothing. It serves only to bridge over the lines of the torpedo body to the contours of the radiator, if the latter is in front. Some builders have even adopted perforated hoods; for, though the hood protects poorly against rain and dust, it is rather effective to prevent the motor heat from escaping.

To be obliged to raise the large piece of tin, which the hood is, every time one may desire to inspect a spark plug or verify the oil level is at least an inconvenience, and it should also be considered that every dent which the hood may receive remains an eyesore, being difficult to remove, and detracts considerably from the appearance and value of a car. The hood, the radiator, and with these the fenders, are the first members in the ensemble of an automobile to proclaim the premature old age which overtakes so many cars, so far as their appearance is concerned, and leads to a much more rapid depreciation than can be accepted as normal for automobiles in the long run.

The question arises: What should be done to a motor to make it get along nicely without a hood? Very little. A few sheet steel caps to close certain joints, notably around the magneto and its connections, over the spark plugs, over the oil level and the breathers. The carbureter would be perfectly contented in a fly-cage, a regular muzzle or feed screen for the motor, a metallic gauze of large area and very fine, to assure the purity of the air admitted to the combustion cham-

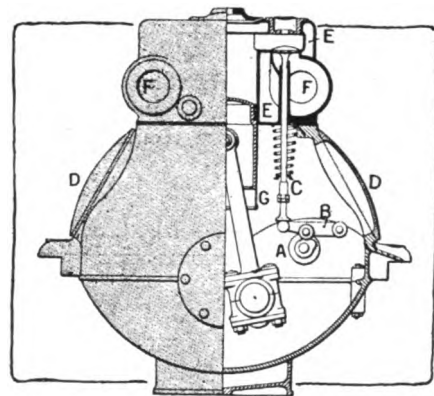

Design of hoodless motor

bers and—what is more important with some modern carbureters—the air admitted to the interior of the carbureter jets.

Esthetic considerations, it is understood, never lose their rights, but in mechanical construction they are served last; and it is found that they always follow the fashion. The hoodless motor would, for that matter, not have the angular contours of the present motor, but would be dealt with more generously by the designer. Having its elbows free it would expand; its knuckles and its hollows would be covered under new rounded forms.

Finally, if the hood disappeared, the radiator would not remain stupidly planted all alone at the front edge of the chassis. It would come back and lean against the dashboard and, with the hood gone, there would be no longer any objection to this position on the score of lacking air current. The surface admitting penetration of air could be made as large as necessary and, assuming that a fan would still be needful, the flywheel could take the place of the fan and could send the air from the radiator surfaces backward under the floor of the car.

The author goes further and argues that, with the hood removed, the front portion of the vehicle frame could be made narrower and that then the objections to fifth-wheel steering would disappear. This could be installed with a considerable saving in cost of production and would give a steering system

not only intrinsically more correct than the Ackerman system but one dispensing with the troublesome tie-rod between the front wheels, one making it easier to drive away from a curb and one permitting the chassis to be pivoted to the middle of the front axle, so as to allow one of the wheels to pass over an obstacle with less shock to the occupants of the vehicle and to the motor. Other writers in the European press are also turning their eyes toward fifth-wheel steering, and a system is described by which the king-bolt becomes unnecessary, as the upper and lower portions of the fifth wheel are held together, one of the retaining flanges being interrupted in places, however, so that the rings can come apart when the lower one is turned back 180 degrees.

PROTECTING THE "SHOFER"

The French are responsible for the attachment shown in the illustration. It is applicable to coupe or landaulet body, and as plainly indicated, may be rolled up on its cylinder by means

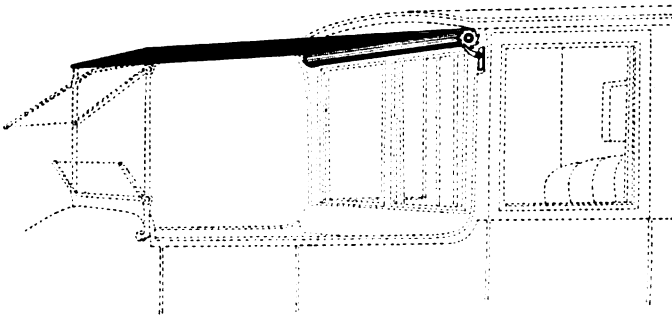

of two strong interior springs. This construction is not entirely approved for vehicles to be used entirely as town cars, but is favored when country trips are also in view. It is patented and said to be very neat, compact and easily operated.

STEAM CYCLECAR, NEW STYLE

A steam cyclecar, to be known as the H.L.B., has been brought out to be sold at 125 pounds in England. The frame is of armored wood, and an inverted semi-elliptic front spring is used, with long semi-elliptic cantilever springs at the rear. Wire wheels, 650 x 65 mm. are fitted, and steering is direct. The wheelbase is 8 ft. 4 in., with a 3 ft. 10 in. track.

The boiler is of the Stanley type, and has 275 tubes of 7/16 in. diameter; the working pressure is 200 lbs. per sq. in., and a safety valve is fitted which blows off at 220 lbs. per sq. in. The boiler is fired by means of paraffin, a pilot burner being run on gasoline, and a mileage of 20 to 25 per gallon of paraffin is obtained, which at 7d. per gallon gives cheaper running than gasoline. Eight gallons of paraffin are carried in a tank at the foot of the dash, under a pressure of 40 or 50 lbs. to the sq. in., and 40 gallons of water are contained in two cylindrical tanks at the rear of the frame.

The engine has two double-acting cylinders, with ordinary link motion, and the steam is slightly superheated before it reaches the cylinders. Lubrication is by a pump worked off a cross-head, and the oil is led direct into the steam pipe. From the engine the drive is by chain to the differential back axle; it is, of course, one of the charms of a steam car that no gearbox is necessary.

Three gauges on the dash indicate the gasoline, paraffin, and steam pressures, and the fire control is also on the dash. The water is controlled by a small wheel under the driver's legs, and the throttle control is mounted on the steering pillar. The valve gear is controlled by a side lever, and a second side lever operates the brake; a foot brake is also fitted, both brakes operating on the back wheels through the differential. In

future models the differential may be replaced by a solid back axle with a slipping device in one wheel, this being considered a still simpler arrangement.

A PROSPEROUS YEAR

The Wright Carriage Body Co., at Moline, Ill., has just closed a most prosperous year as attested by the declaration of a six per cent. annual dividend at the annual stockholders meeting held September 3. No changes were made in the board of directors or officers, the following being reelected for another year: President, T. M. Sechler; secretary-treasurer, E. H. Wilson; directors, T. M. Sechler, E. H. Wilson, W. L. Mueller, Fred Peters, J. S. Gillmore, C. H. Dooley, W. L. Velie.

It was reported that business has held up in splendid shape for the company all through the summer, the plant running continuously without even a shutdown for inventory. Demand for automobile bodies and accessories has been more marked this year than movements in the vehicle and carriage lines. At present the Wright shops are employing better than a three-quarters force, about 150 men.

VACUUM CLEAN THE SHOP

If you ever saw a dusty old shop transformed in 15 minutes by passing the nozzle from a vacuum cleaner over the walls and ceiling, then you have witnessed a most wonderful transformation scene—one worth going miles to see—and especially when it is in your own shop. Dirt and cobwebs disappear as by magic, and by following with a little whitewash, the shop is made 100 per cent. better and easier to work in for a whole year. It is also a much healthier place, and you may have destroyed millions of disease germs, any one of which might have caused you a fit of sickness, should it have chanced to find lodgment in your system!

USE OLD TIRE TO PROTECT NEW ONE

By an arrangement of lugs fitted with rings which may be bolted into an old tire casing, English motorists save wear and tear on their new tires. The device, which has only recently been brought out, is designed to prevent the cover of the good tires from coming in contact with the road surface. Kept in place of the new tire by a chain of a particular design, old covers protect the new tires to such an extent that it is practically impossible for a puncture to occur. There is no creep, no wear, nor friction between the outer cover and the tire, and it is almost impossible to discover from the appearance that a discarded cover is being used on the wheel.

WORKING FULL TIME

The Hoover Wagon Works, York, Pa., is reported by a local paper as operating its East End plant on full time with the regular quota of men. A large number of parcel post and screen mail wagons are being built at the factory, these being shipped to all parts of the country for use in the United States postal service. Recent orders for shipment of parcel post wagons include five for Harrisburg, six for Springfield, Mass., and three for Elmira, N. Y. A consignment of five screen wagons are now in building and will be shipped to Oklahoma City, Okla.

WILL BUILD ADDITION

The Youngstown (O.) Carriage Co. has plans completed for a one-story steel and brick building, to be erected on land adjoining its present building in East Boardman street. The new structure will be about 40 feet wide and will extend the entire depth of the older shop building. The new addition will be used for a general repair shop and automobile garage.

THE COMMERCIAL SITUATION AS AFFECTED BY THE WAR

The Countries at War

So many countries and dependencies are now involved in the great conflict in Europe that it is well to keep them all in mind in connection with present business, domestic or foreign, and also in planning for future trade development; for trade with belligerent countries means undertaking risks of various kinds and the future trade policies of many of the warring countries and their dependencies will be changed or influenced according to the flags which win, says William M. Benney, in a special foreign trade bulletin of the National Association of Manufacturers.

The following countries are now at war: Germany, Austria-Hungary, Servia, Russia, France, Belgium, United Kingdom, Japan, Montenegro.

The colonies and dependencies of the warring nations are not in the position of neutrals, but are technically subject to the same conditions as those of the countries actually at war. While few of these colonies are likely to be the scene of active military operations, all of them will be materially affected by the war, whatever may be the outcome, and a large number of them are important markets for American manufacturers.

The British dominions are those of most interest to American manufacturers as markets, the leading ones being India, Canada, Newfoundland, Australia, New Zealand and South Africa, with numerous smaller colonies, protectorates and dependencies in Central America, South America, West Indies, East and West Africa, and the islands of the Atlantic, Pacific and Indian Oceans.

The chief French colonies and protectorates are Algeria, Tunis, a portion of Morocco, territories in West Africa, French Guiana and a number of islands in the Pacific Ocean.

Germany's most important colonies are in East and West Africa, with minor possessions in China and the islands of the Pacific Ocean.

Belgium has an important colony in the Belgian Congo in Africa.

The land possessions of all the other warring countries are practically contiguous.

Canada has already taken an active part in the war and is sending 20,000 men or more to the front, and is preparing to send still more. Canada has also made provisions for a war fund of \$100,000,000, and the dominion and provincial governments are in other ways affording material assistance to the United Kingdom.

Australia, New Zealand and South Africa are also lending strong support to the mother country in men, money and provisions, and the smaller colonies are doing their share.

With the prolongation of hostilities, there is grave danger of Italy being drawn into the great conflict.

Portugal, while not having made formal declaration of war, has announced its adherence to its old alliance with the United Kingdom and stands ready to render assistance to that kingdom when called upon. Portugal has large colonies in Africa.

With respect to Turkey, while there are temptations for that country to participate, there are several strong influences which are likely to offset this temptation.

With regard to Japan's action, there is no good reason for believing under present conditions that Japan will not act in good faith and confine her military and naval operations to the region necessary for the reduction of Germany's possessions in China.

So far as Germany's island possessions in the Pacific are concerned, these are more likely to be seized by Australia and New Zealand than by the Japanese.

Duration of the War

At the beginning of the war nearly all the experts on military matters believed that on account of the vast numbers engaged

and the enormous expenditures the war could only last for a comparatively short time, six months at the most. Recent developments, however, appear to be causing a change of opinion among experts, who now see the possibilities of a long drawn out conflict. This opinion is based on the apparent determination of the British Empire to use all its resources in aid of its allies, and these resources, while greater than those of any other nation or empire, could only be made fully available after many more months of preparation. Another month's operation should indicate whether the war is likely to be long drawn out or to be decided within a more limited period. A long drawn out war would in some ways cause more hardship and, at the same time afford greater opportunities to the American manufacturer, and therefore impose upon him still graver responsibilities in supplying the world's needs than does the present condition of affairs.

Demands for American Goods

By cable, by post and by personal calls the demand for supplies of all kinds from the United States continues to come in from both belligerent and neutral countries. Many of these demands are urgent. Some are for goods which the United States largely imports and therefore cannot export and at the same time supply home requirements. But with neutral as well as belligerent nations declaring moratoria and foreign exchange still unsettled much of this business is still in abeyance.

Foreign Exchange

The situation with respect to foreign exchange shows but slight change. Cable transfers have been made possible with several countries, but only for limited amounts. There is still no open market for time drafts of any kind. With respect to unpaid drafts which are coming back a committee of prominent New York bankers have agreed to liquidate them at the same rate of exchange they were bought, plus interest at six per cent.

Shipping Facilities

There has been a gradual improvement in the shipping situation, and for Latin-American trade there appears to be sufficient tonnage for taking care of the goods offered. Nevertheless, to all points there is some apprehension and will be so long as cruisers are afloat liable to seize British and French vessels which, with the elimination of the German commercial fleet, are called upon to take care of a still greater part of the world's sea-borne commerce.

Congress has passed measures to aid in the rehabilitation of the American merchant marine, but much still remains to be done in this line before vessels sailing under the American flag will be an important factor in the situation. Further details in regard to this matter will be given in subsequent bulletins.

It is impossible to make shipments just now to Austria, Germany, Turkey, Greece, Balkan States, Switzerland and Belgium. The only possible way to Russia is via the Pacific Coast out of 'Frisco and thence via Vladivostok, but the time is exceptionally long. From present indications, we do not think you will be able to ship to Italy. Although the steamers are running, they are only carrying government supplies, and it is impossible to secure any space whatsoever.

Shipments to interior points in Great Britain can be handled, but to France none whatsoever. We can only quote to seaport, and same conditions apply to Holland. To Portugal shipments to interior points can be effected. Mediterranean ports, in most instances, have been closed, and outside of Alexandria, Egypt, there is no service to offer. With the exception of the above mentioned points, it is possible to ship at the present time due to the fact that conditions seem to only affect the parts of Europe where hostilities are taking place. All except German lines are now operating to various destinations outside of this section of the world.

A Word to the Manufacturer

Never before has the American manufacturer been subject to so much urgent appeal and gratuitous advice on trade oppor-

tunities abroad as at the present time. If the average manufacturer has not demonstrated his cool-headedness as well as his business sagacity by success at home, he might be led to believe that all he now has to do is to write to foreign merchants in order to reap a rich harvest of orders and start a lucrative foreign trade at once.

The manufacturer, who, by careful effort, has already built up a foreign trade certainly has before him great opportunities for extending that trade. This he can be relied upon to use his best efforts to attain, but he has difficulties in the way of a kind which he has not before encountered, and consequently knows better than most of his advisers how much more care and attention he now has to give to the foreign trade problems than in ordinary times. The manufacturer who so far has not looked out for foreign markets and expects to secure a strong foothold therein simply by sending out literature or letters in the language of the country, in a great many cases, is doomed to disappointment. The letter and circular method is not usually effective in ordinary times in a large proportion of cases. Under present conditions much more than the average letter and printed matter, no matter how well written and illustrated, will be necessary to initiate, hold and develop business with other lands.

What Loss of German Market Means and Where It May Be Recovered

Germany is the third largest customer for American goods and according to American statistics purchased from the United States in the fiscal year 1913 goods to the value of \$328,000,000. The total loss of Germany's trade even for one year it will therefore be seen would be a great blow to American commerce. Under present conditions, the other countries of Europe cannot absorb the goods which have heretofore been used by Germany; their own importations are more likely to fall seriously below those of former years.

Consisting as they do largely of raw materials and of partly manufactured goods, we must look to the increased consumption of such goods in American mills and factories to make up for the greater portion of this loss, and this increased consumption on our part can only be achieved by a larger sale of the finished products into which enter the articles usually exported by us to Germany. Germany's own customers will necessarily be seriously handicapped if they cannot secure the goods which they have usually purchased from that country.

Most of the writers for the daily press have called attention only to the possibilities of increased trade with Latin-America on account of the great war. If we look at the trade of Germany with the ten republics of South America, for instance, we find that large as that trade is, it falls far short of the volume of our own sales to Germany. On the other hand, the United States is a large buyer of German goods, and while the shutting off of these German imports means embarrassment for some of our industries, it also affords opportunities for larger sales of domestic competing products in many lines.

Germany also has a valuable trade with Canada, Mexico, Cuba and Central America.

We have then the following possibilities in the western hemisphere in the national balancing of trade:

Possible loss of sales to Germany in one year.....	\$328,000,000
German sales to United States, 1913....	\$185,000,000
German sales to the ten republics of	
South America, 1912 or 1913.....	166,820,000
German sales to Central America, 1912	4,060,000
German sales to Mexico, 1912.....	11,914,000
German sales to Cuba, 1912.....	7,573,000
German sales to Canada, 1913.....	15,500,000

Possible sales to German customers in the western hemisphere

\$390,867,000

The total German market, therefore, in the western hemisphere appears to be considerably in excess of the American market in Germany. However, in addition to the \$328,000,000 accredited as sales to Germany, many millions of dollars worth

of American goods are bought or handled by Germany for consumption in Austria-Hungary, Russia, Balkan States and Switzerland, in the marketing of which Germany can no longer help us.

In this brief survey we have simply looked on the United States as a merchant balancing his accounts. To the individual manufacturer the aspect of the situation is somewhat different, as he is either hampered by the shutting off of supplies of raw materials or the loss of a customer, or aided by the termination of keen competition in the home or other markets.

Still keeping in mind the possibilities of the South American markets, we give below details from German statistics for 1912, the latest now available, of Germany's total exports to the ten republics of South America—marks being reduced to dollars at the ratio of four to one.

Argentina	\$59,860,000
Brazil (1913)	49,950,000
Chile	28,000,000
Peru	4,300,000
Paraguay	550,000
Uruguay	11,000,000
Bolivia	4,450,000
Colombia	4,000,000
Ecuador	1,650,000
Venezuela	3,060,000
	<hr/>
	\$166,820,000

HOME-MADE METHOD FOR WASHING AUTOMOBILES

The following is intended as a tip to car owners, but it is usable in small shops or repair departments where a hose or running water is not convenient.

Take an ordinary garden water-can, and remove the rose. Fill up and stand it on the ground. When ready for washing, pass the left hand forearm under the handle, gripping the front edge of the can with the tips of the left-hand fingers. Now lift, and it will be found that the weight of the can rests against the upper part of the wrist, while the finger tips easily control the tipping angle of the can itself, and so regulate the flow of water from the spout, while the right hand is free to use the cleaning brush at the same time. A 1½ gallon water-can is best for the purpose, as its weight is not too great for the ordinary man to manipulate with ease. The secret of cleaning a car rapidly and at the same time well lies in the plentiful use of water; it also ensures as little scratching of the varnish as possible. Mud should never be removed from the car when dry, as it is apt to take the varnish with it, and it should be washed off with water rather than wiped off with the cleaning cloth. If a car comes in muddy it saves time and trouble to swill it down at once while the mud is still soft, besides being good for the car.

CAR ACCESSIBILITY

The trouble with many motor car constructions is the awkward way parts are put together. Commenting on this, we have an English view as put forth by The Light Car and Cyclecar, wherein it is stated that accessibility and simplicity ought to go hand in hand, and in the majority of cases they undoubtedly do. Now, light cars, and especially cyclecars, can usually lay claim to the attribute of simplicity, but in several instances they fall short when accessibility is considered. If a little forethought were exercised in the design there would be no necessity to have to take the engine out of the frame when, for some reason or other, it was desired to remove the magneto, as we noticed recently in a machine. To aggravate matters more in the case in question, the engine could not be lifted out of the frame without first removing the body.

It is not a question of money, for the cost of making a machine in which every nut was more or less accessible would probably come out at a lower price, and the use of special spanners

would be obviated. Even when this inaccessibility occurs in one machine it is very often not remedied in a new model, because the designer seldom if ever drives the machine he has been instrumental in bringing into being. It should be the policy of all manufacturers to compel their chief designer to drive one of their machines. We should then hear very little of inaccessibility. There is nothing more annoying for an owner than to have to remove the inlet and exhaust piping, and possibly the magneto, in order to perform a simple operation like adjusting the valve tappets. Each year manufacturers lose from this cause customers who are otherwise satisfied with their machines, so that an improvement in this direction would be a benefit to the makers as well as to the general public.

LARGE OR SMALL WHEELS

It might be held that the large wheel is altogether desirable, and certainly its advantages count far more than its disadvantages. The worst that can be said against the large wheel is its weight, and it is an old and well established fact that weight in the wheels is bad for speed and liveliness. Obviously it is impossible to build a large wheel of equal strength to a small one for the same weight; the weight increases more rapidly than the diameter, as the rim and the hub are further apart and the lateral strength in particular must be correspondingly reduced.

A heavy wheel acts as a flywheel, and considerable energy would be put in and taken out in starting and stopping, so that the acceleration is more expensive to make, but here we should

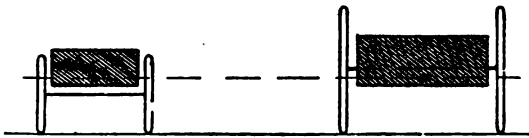

Relative position of center of gravity to the wheel centers, according to size of wheel

remember that the final gear reduction in the axle must be less with the larger wheel, which means a still smaller bevel pinion and a consequently lower transmission efficiency than when the bevels are more nearly of the same size.

However, if the reader likes to sum up impartially, he will find the balance of advantages with the large wheel, the pros and cons being very much as follows:

For	Against
Less power absorbed in driving.	Slight reduction in efficiency of final transmission.
Reduced vibration.	Reduced acceleration.
Lower tire costs.	Greater first cost of wheels.
Greater stability.	Added weight.
Greater comfort.	
Better appearance.	

From the facts, which are apparent, it is evident that for everything but speed work on good surfaces the large wheel is the proper type, and that makers might yet increase their wheel sizes.

SOUND

There are many makes of chassis which have a legitimate claim to silent running, consequently if the body develops the slightest jar, rattle, or squeak it is likely to be noticed, and every motor body builder is aware that there are clients who will grumble at the least vestige of sound, and expect him to take long trips with them, so that he may hear for himself "the horrible rattling" under running conditions. In an open car, with its usual metal wings, shields and valances, there are many places where the slightest departure from perfect work-

manship means that a little noise will be set up which, perhaps, is only just heard as the car is running swiftly over a piece of bad road. Wing stays must be absolutely tight at both the chassis and wing end, and for preference bedded in some material which is not sound-conducting, such as leather or felt. Then the modern heavy wing, not being always adequately flapped and stayed, has a tendency to split away at its junction with the step, and if a toolbox is carried near or at this junction, a chatter will often take place between this and the top of the wing. Spare wheels are not featherweight components, and special care should be taken that their weight is properly carried by the stays provided. Some cape hoods when down are not always tightly fastened to the body props, and the mechanism itself may be a trifle loose in some of the joints. Of course, it is a hundred to one that the trouble will be located in the doors; this should be combated by means of properly-dimensioned standing pillars of sound timber, well-fastened panels, hinges erring on the right side for strength, and two instead of the usual solitary dovetail. Chassis side members are not always finished dead to template, nor is either side a facsimile of the other, and it sometimes requires a genius to bed the runner so that it fits properly all the way from the dashboard to the hind cross-member, and one leading maker advocates bedding the body on a strip of felt. Floorboards, as they often have to be made removable, are apt to jump about a little if they have shrunk somewhat since first fitted, while some portion of the wind screen may be the cause of the trouble, or loose tools in the locker or toolbox. The closed body with domed roof often gives trouble, not only in the roof itself, but interior noises of any sort are magnified in a way which is naturally absent in an open body.

THE LAUGH IS NOW AN ECHO

At the annual meeting of the coach builders in New Zealand, Mr. J. O. White had a few remarks to make that so clearly point the change of mind among vehicle builders, that they are good to quote, because they make such timely hits. He said:

Within the last 20 years we have seen greater changes than any two centuries have witnessed before, and we are apt to be unaware of the transformation of the times. We have seen three wholly new forms of travel arise and develop—the bicycle, the motor car and the aeroplane—each sufficient in itself to make a complete revolution in the habits of a population. At one time there seemed to be something inherently humorous in the mere sight of a mechanically driven vehicle, which prompted chuckles of a superior mirth among those who chanced to be drawn at the time in a horse vehicle.

Anybody who could subdue his feelings sufficiently to talk seriously stigmatised the new instruments as useless nuisances, stink traps and rattle boxes. Anything uncomplimentary he could think of. Everybody prophesied that no more would be seen of the things after a few month, when the feather-headed cranks who drove them had all been blown up and their remains decently buried. But it is astonishing to observe how difficult it is to find anybody nowadays who said all these things, and smiled all those smiles 20 years ago. One and all strenuously deny the faintest chuckle, and a good many of us claim to have foreseen the triumphant rise of the automobile from the very beginning.

The triumph of motoring began when a number of people discovered it was expensive. Then there was a rush of people who envy the distinction of incurring expense. Today the first-rate car runs with the certainty and regularity of a mail train, and with none of its noise, and it ticks away, like a 400-day clock, as long as you choose to drive it. And now that its popularity and utility are so well established, it appears almost incredible that carriage builders with world-wide reputations, should have been so skeptical, and should have hesitated so long a time to take up car building. Conservative to the last degree, and with a conviction that the motor car was but an

experiment first, then a passing craze, and altogether an unreliable means of locomotion compared with the good old carriage and pair, their erring judgment in this matter must have resulted in heavy loss. It is hard to realize that in these advanced times so many should have been taken at a disadvantage. They did not anticipate that in so short a space of time mechanical troubles would be eliminated, and that silent, speedy and comfortable cars would so readily supersede those that were first introduced.

PLAYING COMBINATIONS

One of the largest wagon manufacturers in the country declares that there are more than 5,000 different combinations of farm wagons in use in the United States. In the wagon business the diversity of sizes, types and combinations have been added to from time to time to such an extent that the average manufacturer is confronted with an assortment of 700 sets of different kinds of wheels, when sizes of tires and height of wheels are considered. In other words to fill an order for twenty wagons it would require a stock of 14,000 sets of wheels; and if the order called for 25 wagons, notwithstanding the fact that there would be 13,980 sets of wheels in stock, the order still could not be filled from stock; nor could the next order coming from a dealer in the same county specifying the same kinds of wheels.

The matter of specifying gears and boxes is even more complicated, and where the gears and boxes are combined with the different kinds of brakes made, different types of reaches, triple top boxes, etc., the combinations available to draw from run away up into the thousands. In speaking of variety and diversity it should be remembered that wood stock must be seasoned differently for different sections of the country. Wood stock that will hold the tires and skeins tight in Illinois and Missouri cannot be used in many parts of Texas, New Mexico, Arizona and the mountain sections where the altitude affects wood very materially. Wood stock must be specially seasoned for use in those sections. For example, the wood stock used in Utah and Idaho and other similar territories requires seasoning in a way that makes it acclimated, so to speak, before the wagon is put together.

Dealers and jobbers as a rule believe that the number of wagons actually required to serve every purpose could be reduced to three or four sizes with injury to no one, and a great saving to the dealer, jobber, farmer and manufacturer, this according to Farm Implement News. Letters from the officers of dealers' associations recently published in the news columns of this paper indicate that the retail trade is heartily in favor of standardization, and will assist in every way possible to simplify the wagon business. To carry farm wagons in stock as they are built today requires such an enormous investment compared with the volume of sales that every dealer not selling the line feels discouraged about handling wagons, and those who are already in the business say that it is unsatisfactory and yields little or no profit.

The question of standardization is to be gone into thoroughly at the forthcoming dealers' conventions as well as at the manufacturers' convention this fall.

A table is being compiled to show what may be accomplished by standardization in the farm wagon business. Certainly there is no valid reason for continuing a practice long ago found so unprofitable.

NEW FINISH

Describing all the features of a new English model, we find room here for a description of the body, as given in The Motor:

The whole of the panel work, wings, and mudshields are treated by a special metallic process that was introduced for motorcars by Harold Lambert. The car is finished in virgin

silver, the resemblance to a surface of that rare metal being marked. All the metal fittings, such as lamps, radiator, etc., were done in a beautiful black, resembling polished ebony, and this, we understand, is also a special process.

One of the most interesting features of the finish of this car is the fact that mud, tar, or grease will not adhere in any way, and can be readily removed, even by the hand or a rough piece of cloth. There is no necessity for the hose or continual washing, and Mr. Lamber demonstrated that, by one or two strokes of the hand or a piece of cloth, the mud is immediately removed, leaving no sign behind, and, moreover, with no trace whatsoever of scratching. We understand there are a variety of colors in this process apart from those that are purely metallic, but the base and foundation appears to be metal precipitated in some way instead of the usual paint and varnish process. No varnish seems to be present in the material, and we understand that it is a secret process and that Charles Jarrott and Letts, Ltd., have made continual experiments with it on their cars to the order of customers.

EXTRA FIRESTONE TIRE & RUBBER DIVIDEND

The Firestone Tire & Rubber Co. has declared a quarterly dividend of 3 per cent. and an extra dividend of 2 per cent. on the common stock; also a regular quarterly dividend of 1½ per cent. on the preferred stock. All the dividends are payable October 15 to stock of record of October 1. The previous declaration on the common stock was 2½ per cent.

The common dividend represent an advance in the rate from 10 per cent. to 12 per cent. per annum. The extra dividend has not been declared heretofore.

The gross sales of the company, in the fiscal year ended July 31, 1914, exceeded \$19,000,000, against \$16,000,000 in the previous year, \$11,500,000 in the fiscal year 1912, \$7,500,000 in the 1911 year and \$5,000,000 in the year ended July 31, 1910.

The company has \$3,000,000 common and \$1,000,000 preferred stock outstanding, so that earnings, which amount to approximately \$3,000,000, are at the rate of nearly 100 per cent. on the common stock after the 7 per cent. cumulative dividends on the preferred stock.

THE MACINTOSH CUSHION RUBBER TIRE FOR MOTORVANS

The McIntosh cushion tire has been designed for use on motorvans. This latest English product presents a somewhat curious appearance; it consists of a series of alternate hard black and soft red rubber blocks, vulcanized together to form a complete band. The actual tire is built up of two of these bands superimposed, and so positioned that the blocks in the upper band cross those in the lower. By making the tire in this manner it is claimed that the drive is not taken solely through the soft cushion rubber, and thus this is preserved to perform its real function of eliminating road shocks as far as possible; the design has a further advantage in that the soft rubber is prevented by the hard rubber from spreading to any great extent when under load.

TRY THIS AT THE SINK

Hands that are very dirty may be better cleaned than with soap alone by adding a little sugar to the soap. The sugar increases the lather and the cleaning power of the soap, too. It will also remove stains.

PATENTED TEMPERING

A composition for tempering, under patent, for steel, is made up with cyanide of potassium, 4 oz.; borax, 3 oz.; sal soda, 2 oz.; saltpeter, 2 oz.; blue vitriol, 2 oz.; sal^t, 1 oz.; sal ammoniac, 3 oz., and rosin, ½ oz.

TAME RUBBER DISPLACING WILD

Tame rubber, as that grown in plantations is termed, is supplanting wild rubber in the markets of the world. A few years ago Brazil had almost a monopoly of the world's fine-rubber supply, and prices were controlled from Para, the principal shipping point. Men interested in rubber manufactures set out plantations of rubber trees in Sumatra, Ceylon, and other tropical lands, and now much more than half of the world's supply of rubber comes from these plantations.

AFTER ADVANCE, TIRES DECLINE

The tire situation shows an appreciable easing up. Prices in several instances have fallen back to list and the present tendency is downward rather than upward.

Goodyear, which led the advance with 20 per cent., fell back to list, with the explanation that it had secured means of obtaining crude rubber.

Empire followed by removing its advance of 12½ per cent., and the Mohawk company and the Miller Rubber, both of which had advanced 15 per cent., returned to the old list.

HENDERSON BACK WITH COLE

Negotiations are practically complete under the terms of which C. P. Henderson will resume his position of three years ago at the head of the sales organization of the Cole Motor Car Co., Indianapolis, Ind. Homer McKee, who has been acting as director of both sales and advertising, hereafter will devote his attention solely to advertising, which he will handle for the Cole company through the Mahin Advertising Co., of Chicago, for whom he has just opened a branch office in Indianapolis.

MOTOR SPIRIT FROM PLANTS

For some years past, H. Rowley, a western Australian analyst, has been devoting his energies to proving that there is a vast amount of latent commercial wealth in the "Blackboy" and the Zamia palm. Mr. Rowley claims that a new motor spirit can be produced more cheaply in this way than from any other source, and other marketable products include tar, pitch, stock feed, glucose, scents, flooring material, fibre, and disinfectants. The motor spirit has been practically tested, and, it is stated, three local motorcycle races have recently been won with it.

THE "FRA" WRONG AGAIN

Elbert Hubbard says that Dr. B. F. Goodrich was the inventor of the pneumatic tire. The editor of this paper (India Rubber World) knew Dr. Goodrich fairly well, and had from his own lips the story of his life, but no such claim was then made. If there is any truth in the story proofs should be offered, that due credit be given. Otherwise it will be set down as merely another Hubbardeque fancy.

MILBURN WAGON CO. TO BUILD ELECTRICS

After a long period of secret trials the Milburn Wagon Co., Toledo, O., one of the oldest and best known wagon and body manufacturing concerns in the country, will shortly bring out its first electric vehicle, which, it is claimed, will embody many new features in electric vehicle construction.

An imitation-gold color may be made with flake white, ground in varnish and tinted with a touch of vermilion. When striping or lettering is done with this, it will have the appearance of real gilding work.

STEEL A DEAD BLACK

For coloring iron and steel a dead black of superior appearance and permanency, M. Mazure proposes a fluid, of which the following is the formula: One part bismuth chloride, 2 parts mercury bichloride, 1 part copper chloride, 6 parts hydrochloric acid, 5 parts alcohol, and 50 parts water, these being well mixed.

SILVER-WHITE PAINT

A silver-white paint may be prepared from pure white lead ground in oil, 10 pounds lampblack in oil 1/10 oz., dry ultramarine 4 to 5 ounces, linseed oil 1 quart, turpentine 1 quart, japan 1 pint. The formula given is designed to make 1 gallon of paint.

ROAD BUILDERS TO MEET IN CHICAGO

The annual meeting of the American Road Builders' Association, which will be known as the Fifth American Good Roads Congress and Sixth Good Roads show, will be held at the International Amphitheater, Chicago, Ill., on Monday, Tuesday, Wednesday and Thursday, December 14-17, 1914.

PUTTING THICK OIL IN THIN PLACES

Not infrequently it is desirable to lubricate some part of a machine with thick oil which is difficult to inject because of the narrowness of the available opening. In such a case it helps to put the oil can on the exhaust pipe for a short time to let the oil get hot and thin.

FIRESTONE SALES CONVENTION

The annual sales convention of the Firestone Tire & Rubber Co. will be held the third week in October at the factory in Akron, O. More than 250 men will attend from all over the country.

IN NEW SHOP BUILDING

The Harvey Spring Co., Racine, Wis., motor car and vehicle springs, has taken occupancy of its new shop building, 50 x 150 feet, which will enable it to materially increase its production.

DOUBLE PURPOSE RIGS

The detachable top to go over touring bodies, to fit like the cover to a preserving jar, is now appearing on the program frequently as a popular song. Making two vehicles where only one was before should be convenient.

EASY METHOD

If it is a question of ripping a plank into equal strips, use a steel square, and divide 12 inches on the surface (blade) into the needed parts. Then lay the square diagonally on the plank so the twelve-inch mark comes to the edge of the plank, then mark off the dimensions wanted.

IT WASN'T THE BRIDGE

Mrs. Munson's bridge party was a great success socially. The hostess appeared in a large bunch of spring violets.—Lane (W. Va.) Recorder.

CLEAN DIRTY ALUMINUM

Apply a coat of kerosene over night.

HANDY WAGON JACK

The engraving shows an easily made wagon jack that is useful in the wagon maker's shop. The material is 2x4 in. lumber. The short arm at the left is strengthened by an iron brace. The arm that swings the jack is, of course, made of iron, and the forked eye upon which the end of it works is iron nailed on the board. All the hinged arms are simply

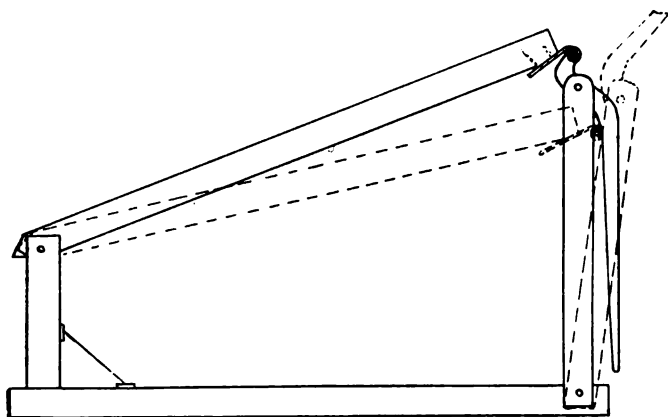

bored, and an iron bolt passed through. Bushings may be provided if desired. These will save excessive wear on the wood hole, which will in time become elongated. The base of the jack is 3 ft. 3 in. long, the short arm or standard at the left is 10 in. high, and the right wooden arm is 22 in. in length. The iron arm is also 22 in. long. The engraving illustrates the jack in its two positions.

THE ROTARY TYPE MOTOR

Those who believe that the rotary type of motor so largely used for aeroplanes is intrinsically very costly to manufacture will be interested to learn—from the commercial information column in *La Pratique Automobile*, that the gross receipts of the Gnome motor company for 1913 amounted to 10,640,000 francs, as against 6,338,000 francs for 1912, and that the net profits were 8,640,000 francs in 1913 and 5,258,000 francs in 1912. Thirty per cent. of the net profits, or 2,400,000 francs, is distributed in dividends.

DEVICE FOR RECHARGING AUTOMOBILE MAGNETOS

The recharging of the field magnets of automobile magnetos, which ordinarily needs to be done at intervals of from six to ten months, may now be carried out in any garage by unskilled attendants by means of a device that has just made its appearance on the market. This device is simply applied to the poles of the magnet and no drawing or rubbing of the magnet is required. It is compact and portable and can be operated by any direct current of the proper voltage. It is claimed that with a 6-volt storage battery or with six dry cells an ordinary magnet can be thoroughly charged in from 15 seconds to one minute.

If you have exhausted dry batteries and want to renew them and save your pocket, proceed thus: Sal ammoniac and zinc chloride, each 15 cents a pound; manganese peroxide, plaster of paris, and powdered carbon, each 10 cents a pound.

According to the following formula: Sal ammoniac, 1 pound; zinc oxide chloride, 1 pound; manganese peroxide, $\frac{1}{2}$ pound; plaster of paris, $\frac{1}{2}$ pound, and powdered carbon, 1 pound, will cost you about 55 cents, and will be found sufficient for renewing four standard dry batteries, thus making the cost for renewing each cell about 14 cents.

METHOD OF BRAZING

First clean and clamp the parts to be brazed together tightly. Heat and apply pulverized clean borax. Take a piece of common soft brass in separate tongs and heat to a melting state. Rub this lightly on the part to be brazed. By using this method it is not necessary to have the material you wish to unite as hot as would otherwise be necessary. There is thus less danger of burning or melting, especially if cast iron is to be brazed. Band saws, in fact anything that can be heated a little above a cherry red in a blacksmith fire can be brazed successfully.

HO! CHANCE FOR A JOB

Dodge Bros., Detroit, Mich., will put about 10,000 men to work beginning October when a million dollar addition to the plant will be completed. This consists of a four-story assembly room 1,000 feet long and 70 feet wide, and a press punching building. Machinery worth \$300,000 will be installed.

CHANGES MANAGEMENT

Wm. J. Gims has resigned as general manager and treasurer of the Carroll Vehicle Co., at Portsmouth, O., and has been succeeded by John Dennison, who is a practical vehicle man, and who has been connected with the concern for some time.

WOOD WORKING PLANT FOR BARBOURVILLE

A wood working plant will be installed by T. W. Minton & Son, at Barbourville, Ky., who will manufacture buggy, wagon and automobile parts. The plant will cover two acres and will be installed at once, employing about 40 men.

CARRIAGE COMPANY BANKRUPT

The Taylor Carriage Co., a small repair concern located at Lynchburg, Va., has assigned to B. E. Hughes, trustee, for the benefit of creditors. The assets will amount to about \$1,000, with an aggregate of \$3,000 liabilities.

GENERAL MANAGER FOR H. COLLIER SMITH

William J. Marshall has been appointed general manager for H. Collier Smith, Detroit, manufacturer of special sheet metal machinery. Previously he was president of the Mercury Cycle-car Co., Detroit.

THE PARRY CATALOG

The just issued Parry Mfg. Co. catalog is an advance on all previous efforts at good book making. The arrangement is novel, informing and highly useful to the recipient in many unusual ways.

ELECTRIC VEHICLE SHOW OCTOBER 7-17

An electric vehicle show will be held in Grand Central Palace, New York City, October 7 to 17. The show is under the direction of Charles Parker, of the New York Edison Co.

WAR CLOSES WAGON WORKS

Lack of foreign orders led the Hobson Mfg. Co. to close down its plant at Easton, Pa. The company made heavy wagons for the African and South American trade.

WILL ERECT \$50,000 BUGGY PLANT

The Hackney Buggy Co., of Wilson, N. C., will build a buggy factory, five sections, each 100 x 140 feet, to cost \$50,000.

FIRES

Fire completely destroyed a three-story frame building belonging to the Nissen wagon works, at Winston Salem, N. C., September 15. The building was used for the making of hubs and the sawing of green lumber. The loss is estimated at \$20,000. Insurance was carried on the plant to the extent of about 20 per cent. of its value. Mr. Nissen stated that he had just stored an unusually large quantity of green lumber in the building during the past few days, and that this made his loss considerably heavier than it would have been under normal conditions. The fire did not interfere with business.

Fire completely destroyed the plants of F. B. Leonard & Co., and Leonard & Leonard, at Metropolis, Ill., September 10. Automobile parts and buggy and wagon stock were manufactured at the plants.

The wagon and paint shops of F. E. Estergreen burned at Hastings, Minn., August 24. The loss is \$5,000; insurance, \$2,500.

DEATH OF OLD TIME WAGON BUILDER

Levi Mullholand, 82, long a wagon and carriage maker at McCutchenville, O., was found dead in his bed, September 14. Heart trouble is believed to be the cause of his death. His widow and five children survive.

CHANGE

S. H. Woods, formerly designer with General Vehicle Co., now inspector Compensation Inspector Rating Board, New York City.

The S. A. E. Bulletin announces that an experienced automobile draftsman, resident in New York City preferred, is needed. The particulars might be had by writing the secretary, 1790 Broadway, New York. Technical School please notice.

NEW VELIE SALES MANAGER

Royal R. Bush, formerly of the Kingman Plow Co., at Peoria, Ill., is the new director of sales for the Velie Motor Vehicle Co., in Moline, succeeding Charles E. Giltner, who has held the position for the last two years. Mr. Bush will have personal supervision over pleasure car sales through all Velie agencies, and Henry T. Wheelock continues as manager of the motor truck sales department.

WANTS

Help and situation wanted advertisements, 1 cent a word; all other advertisements in this department, 5 cents a word; initials and figures count as words. Minimum price, 30 cents for each advertisement.

PATENTS

Patents—H. W. T. Jenner, patent attorney and mechanical expert, 606 F St., Washington, D. C. Established 1883. I make a free examination and report if a patent can be had and exactly what it will cost. Send for circular.

SITUATIONS WANTED

Situation wanted as carriage painter, by an all round man in paint shop; wishes job in small custom shop in country town. Box 29, care The Hub, 24 Murray street, New York.

Wanted—Position as sales manager or salesman; 18 years active experience; familiar with credits and every detail of vehicle business. Chas. H. Kelly, care Studebaker Bros. Co., 445 Broadway, New York City.

Rubber cement is divided into two classes, namely: a simple solution of the gum which by the evaporation of the solvent leaves a thin layer of the rubber between the parts to be stuck together; and a compound cement, which, after being applied and the pieces stuck together, is vulcanized, and to a certain extent becomes incorporated as a part of the article so formed. The first is used very largely in the manufacture of leather goods, such as boots and shoes, bags, pocket books and similar articles. The compound cements are mainly used in the various rubber industries, such as waterproof clothing manufacture, the druggists' sundry business and in automobile tire work. For automobile tire work, the following compound has been found effective and satisfactory: Fine para, 24 parts; whiting, 12 parts; litharge, 16 parts; sulphur, 1¼ parts; one pound to each gallon of naphtha. A richer cement for the same purpose is: Fine para, 33 parts; litharge, 6 parts; sulphur, 3 parts.

INDEX TO ADVERTISERS

Baltimore Hub-Wheel and Mfg. Co.....	48
Cargill Co., The.....	40
Central Mfg. Co.....	3
Columbus Bolt Works.....	4th cover
Correspondence School of Carriage and Motor Drafting...	47
Cowles & Co., C.....	48
Cumberland Hotel.....	2d cover
Dowler, Chas. L.....	40
Eccles, Richard, Co.....	44
Evansville Carriage Woodstock Co.....	42
Fairfield Rubber Co.....	44
Firestone Tire & Rubber Co.....	43
Gifford, John A., & Son.....	41
Howell-Hinchman Co.	41
Jones & Co., Phineas.....	2d cover
Keystone Forging Co., The.....	47
Keystone Paint & Filler Co.....	40
Keystone Spring Works.....	40
Lawson Co., F. H., The.....	41
Masury, John W., & Son.....	2d cover
Meyer, John C., & Co.....	48
Miller Bros.	48
Mulholland Co., The.....	48
Murphy Varnish Co.....	4
National Spring & Wire Co.....	47
Payne Co., E. Scott.....	48
Pierce, F. O., Co.....	2
Porter, H. K.....	44
Sheldon Axle Co.....	44
Sherwin-Williams Co.	1
Sidney Mfg. Co., The.....	45
Skinner Bending Co., The J. M.....	48
Standard Oil Cloth Co.....	46
Standard Wheel Co.....	48
Stewart-Mowry Co.....	4th cover
Straus & Sons, M.....	40
Technical School for Carriage Draftsmen and Mechanics..	44
Virginia and North Carolina Wheel Co.....	4th cover
West Tire Setter Co.....	42
White-Quehl Mfg. Co.....	48
Wilcox Mfg. Co., D.....	1
Wiley Co., C. A.....	3d cover

M. STRAUS & SONS
NEWARK, NEW JERSEY

Highest Grade
From Coast To Coast



HAND BUFFED,
SPECIAL MACHINE
BUFFED,
DEEP BUFFS AND SPLITS - IN COLORS OR SPANISH

**UPHOLSTERY
LEATHER**

SEND YOUR PATTERNS FOR CUT STOCK

Cargill Service

has brought to the Cargill Company more Vehicle Catalogues than are made by any other printing house in America.

Cargill Quality is bringing The Best Automobile Catalogues to our plant for Complete production—watch for our imprint in the Season's best books.

THE CARGILL COMPANY

DESIGNERS
ENGRAVERS



PRINTERS
& BINDERS

Grand Rapids, Michigan



CHARLES L. DOWLER

PURE STEARIC ACID CANDLES
SPRINGS, WHEELS
CARRIAGE AND WAGON HARDWARE
CUSHION MANUFACTURER

108 N. THIRD ST.
PHILADELPHIA

Distributing Agent for
PENNSYLVANIA, NEW JERSEY,
MARYLAND, DELAWARE

KEYSTONE BLACK FILLER

MAKES A PERFECT
ROUGHSTUFF

For Automobile Bodies and Parts

It fills the pores of Metal and Wood perfectly. Sandpapers easily and produces a fine, smooth surface that DOES NOT CRACK, SCALE NOR PEEL.

POMEROY & FISCHER, New York
Selling Agents to Vehicle Trade

KEYSTONE PAINT AND FILLER CO., Muncy, Pa.

KEYSTONE SPRING WORKS, Inc.
MANUFACTURERS OF HIGH-GRADE

Carriage, Wagon and Automobile Springs

Thirteenth and Buttonwood Sts. ESTABLISHED 1870 PHILADELPHIA, PA., U. S. A.

**Automobile Hardware
and Trimmings**

JOHN A. GIFFORD & SON

25 PARK PLACE

22 MURRAY ST.

NEW YORK

**Carriage and Wagon
Materials**

The Howell-Hinchman Co.

Leather Manufacturers

Tannery, Works and Salesroom

Middletown New York

FIFTY years engaged in making
old reliable Bark Tanned
Leather, for Automobile, Carriage
or Furniture Upholstering
Spanish Leathers in colors, our
specialty

Established 1865

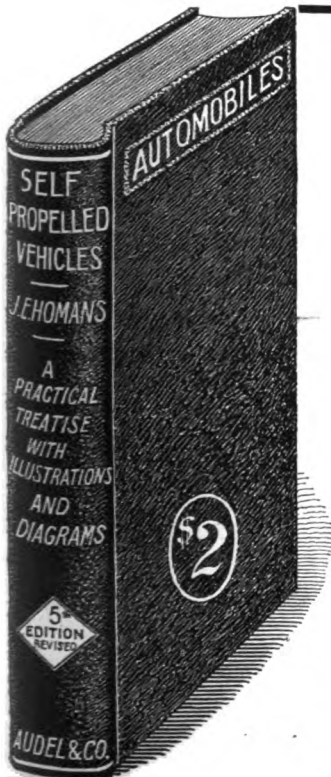

**"Self-Propelled
Vehicles"**

Fifth Edition, Revised.

A practical treatise on the theory, construction, operation, care and management of all kinds of Automobiles.

By

JAMES E. HOMANS, A.M.

Contains 608 pages and upwards of 500 illustrations and diagrams, giving the essential details of construction and many important points on the successful operation of the various types of motor carriages driven by steam, gasoline and electricity.

This work is now the accepted standard, explaining the principles of construction and operation in a clear and helpful way. This book will be sent postpaid to any address in the United States, Mexico or Canada upon receipt of \$2.00.

Address

Trade News Publishing Co.

24 Murray Street, New York

**Lawson's Sunken Panel, Twin
Metal Buggy Seats**



The Strongest—Neatest on the Market

Made in six sizes of 20 gauge automobile sheet metal. The Lawson seats are edged and bumped together by heavy presses.

We Use No Solder

Our seats were never known to come apart or rumble.

Write for Prices

The F. H. Lawson Co.

(Established 1816)

Cincinnati - - - Ohio

Evansville Carriage Woodstock Company

Manufacturers of High Grade

Carriage, Buggy and Spring Wagon

GEAR WOODS

When we say "HIGH GRADE" we are justified in doing so, because builders of quality vehicles are using our material, and that alone permits us to make this honest assertion

We would be glad to have you write us

EVANSVILLE, IND.

The "Rochester" Helve Hammer

was originally designed especially for the Carriage and Wagon making trade

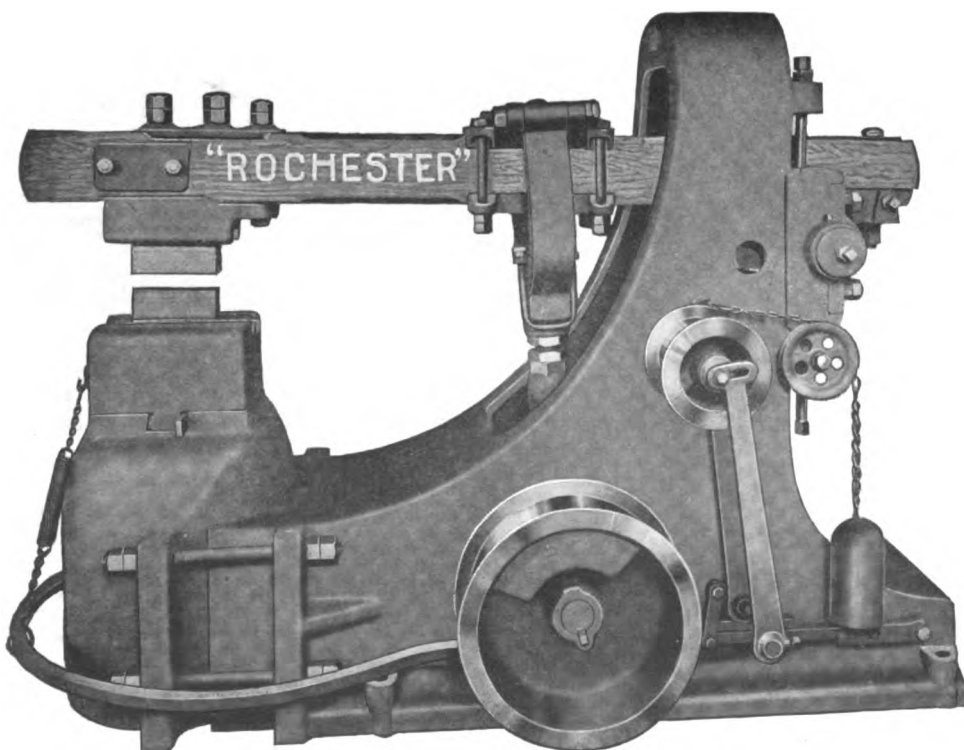

IT IS HIGHLY EFFICIENT AND SOLD AT A REASONABLE PRICE. BUILT IN TWO TYPES OF FRAME AND SIX SIZES—25 LB. TO 100 LB. HEAD. FURNISHED WITH DIES SET LENGTHWISE OR CROSSWISE OF HELVE AS DESIRED. A FINE HAMMER FOR WELDING TIRES.

SEND FOR OUR CATALOG AND PRICES.

... The ...

WEST TIRE SETTER CO.

Rochester, N. Y.

Please mention "The Hub" when you write

Digitized by Google

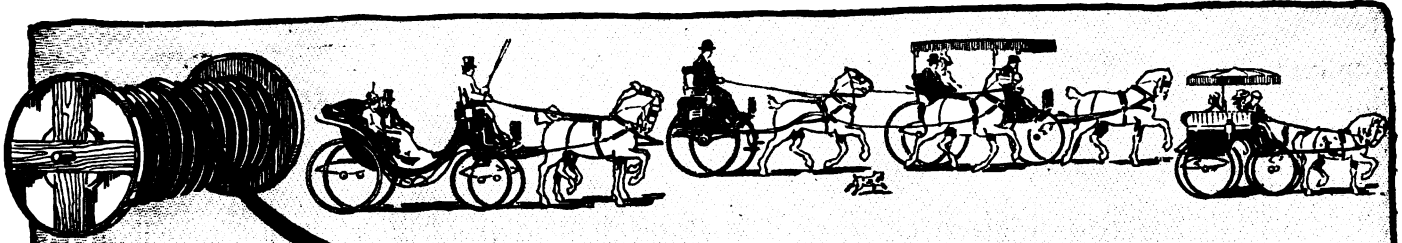

Here's Hoping
 We Meet You At The
 C. B. N. A. Convention,
 Atlantic City,
 September 28th to October 2nd.

Plenty has happened since we met at last year's convention to give us both new and important matters to discuss.

At this writing we see a far bigger year than ever just ahead. You must see it, too. But there are new problems on the way to the big goal. Let's talk them over.

Visit the Firestone Booth

Never before have the Firestone Standards of good measure been so important to you. Never before has the Firestone policy of quality first meant so much.

Hoping you will favor us with a call at our exhibit, and assuring you that its facilities will be at your disposal, we are

Sincerely yours,

Firestone Tire & Rubber Co.
 AKRON, OHIO

Branches and Dealers Everywhere

"America's Largest Exclusive Tire and Rim Makers"

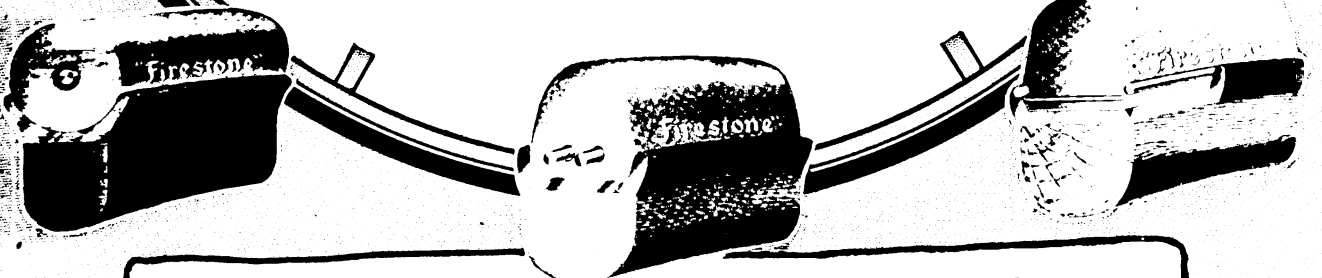

Cushion

There is extra resiliency in this cushion design which makes it a riding favorite.

Internal Wire

For light vehicles—A supreme combination of resilient rubber and tested compound.

Side Wire

These anchor the tire immovably in the channel. Unapproachable for hard and lengthy service.

SHELDON AXLES AND SPRINGS

For Horse-Drawn and Power-Propelled
Vehicles of All Kinds

JUST ENOUGH BETTER THAN OTHERS TO BE NOTICEABLE

When you specify "Sheldon" you are not experimenting with experiments, but are getting Axles and Springs with years of manufacturing experience back of them—Axles and Springs that are selected for important work where conditions make reliability supremely important

SHELDON AXLE COMPANY - WILKES-BARRE, PA.

LARGEST AXLE AND SPRING FACTORY IN THE WORLD

PORTER'S BOLT CLIPPERS

"Easy" "New Easy" Allen-Randall



To Cut 5-16, 3-8, 1-2, 5-8, 3-4 inch.

H. K. PORTER,

EVERETT, MASS.

Richard Eccles Co., Auburn, N.Y.

Manufacturers of

Forgings: Carriage, Wagon, Automobile' Special

Send for Catalogue No. 18;

Also Catalogue of Special Automobile Forgings

THE FAIRFIELD RUBBER COMPANY

Manufacturers of

Carriage Cloth, Imitation Leather,

Automobile Cloths, etc.

FAIRFIELD,

CONNECTICUT

Carriage Mechanics

Desiring to improve their present
Condition should attend the

TECHNICAL SCHOOL

FOR

Carriage Draftsmen and Mechanics

SUPPORTED BY THE

Carriage Builders' National Ass'n

The object of the School is to teach men to design vehicles and make working drawings, and to otherwise facilitate their work in the shop. Only those men employed in carriage or automobile building or their accessory trades are admitted to its privileges.

The classes are conducted in three divisions, viz.: Corresponding, Day, and Evening. The former is open during the entire year, while the day and evening classes are in session only from October 1 to April 1.

The tuition is moderate.

For prospectus and full particulars, write to the instructor,

ANDREW F. JOHNSON,

20 West Forty-fourth St.,

NEW YORK CITY

Sidney Metal Buggy Seats and Metal Bodies

The Best in the World

The Largest and only exclusive Metal Buggy Seat and Metal Bodies builders in the world. Daily capacity about 400 seats.

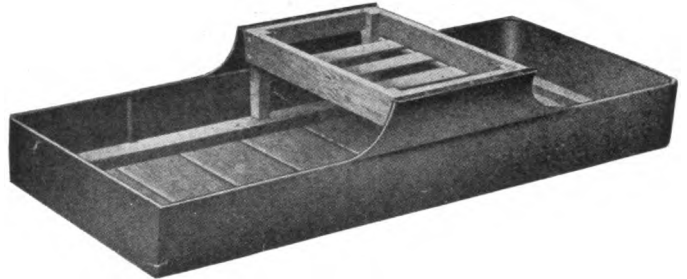

They must be right, otherwise the trade would not have the demand

We know how to make them

Your own design if desired, quantity justifying

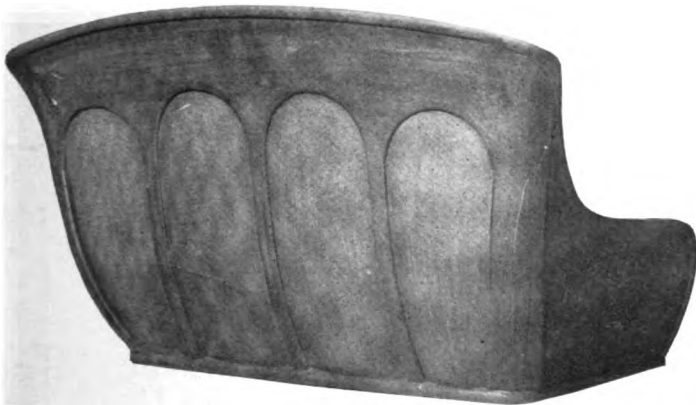

We are adding new and attractive styles for 1915 to an already large line of Metal Seats, which are now ready for your approval. Write for catalog and prices.

Every Seat Guaranteed. Have stood the test for years

Better than ever—and lower in price. Many other new designs. Sizes of seats from 27 to 40 inches.

Before contracting your wants in Buggy Seats for 1915 write us to see the largest line of Metal Seats and Bodies.

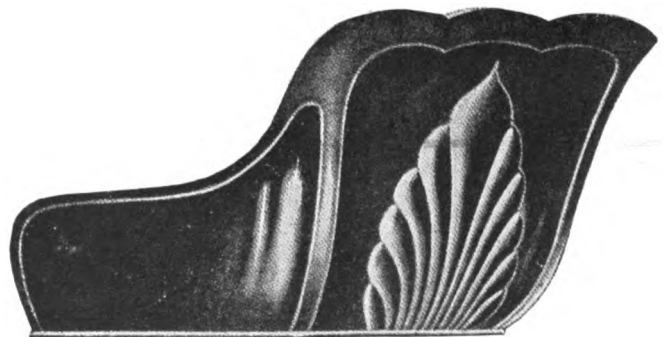

If desired, no solder used

The Sidney Manufacturing Co., Sidney, O.

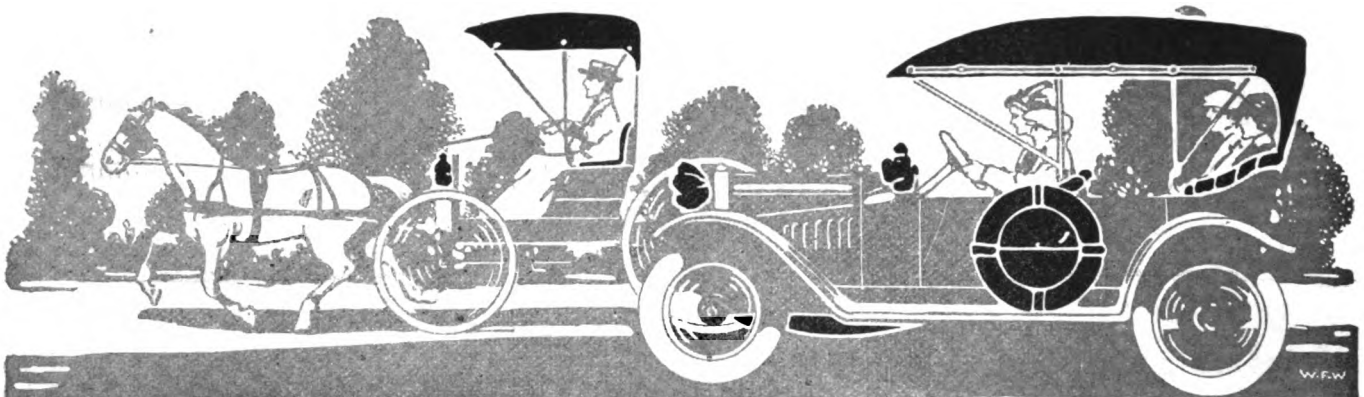

Learn More About The Leading Leather Substitute

Every carriage and automobile manufacturer—every manufacturer of carriage and auto accessories, storm curtains, aprons, lamp covers, tire cases, trunks, etc., should get and examine samples of

MERITAS LEATHER CLOTH

Only by seeing the goods—by testing them—by noting the handsome, durable, non-cracking finish and the fine line of colors can you appreciate the high quality we have attained in the manufacture of a serviceable leather substitute.

There are styles, colors and finishes in MERITAS LEATHER CLOTH suitable for every carriage and auto trimming and upholstery purpose.

It can be had in muslin, duck and drill; dull or glazed; smooth or grained; in black and colors.

Sample book on request—write now and know more about the leading leather substitute.

Write
for
sample
book of
MERITAS
LEATHER CLOTH
NOW

Standard Oil Cloth Co.

320 Broadway, New York

"BLACK VELVET" CUSHION SPRINGS

Manufactured Only by the
NATIONAL SPRING AND WIRE COMPANY
 ALBION, MICH. WINDSOR, ONT.

THE SPRING OF QUALITY.



SPRING or SOFT EDGE CUSHION FRAME
 For Buggies or Other Vehicles. Built of the Highest
 Grade of Steel Wire.

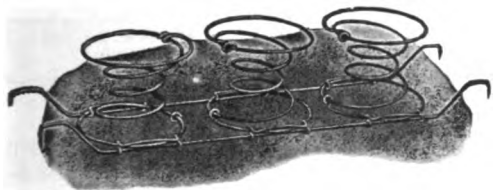

STRIP FOR WOOD OR BOX FRAME

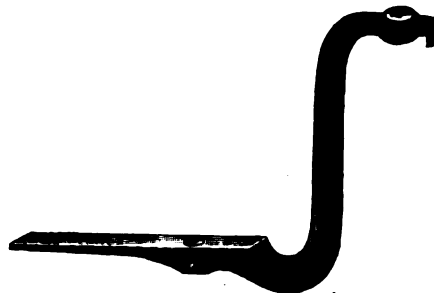
**BODY
LOOPS**

**ALL
SIZES
ALL
STYLES**

MANUFACTURED BY
The Keystone Forging Co.
 Northumberland, Pa.
 WRITE FOR PRICES

Established 1886

**Correspondence School of Carriage and Motor
Carriage Drafting**

A thorough, practical tuition is given through this correspondence school. The theory and practice of construction, bookkeeping, perspective. Many men now hold good positions through taking the courses of instruction.

Principal, **THOS. MATTISON,**
 Hillside Avenue, Bitterne Park,
 Southampton, England

Author of "The Coach Body Makers' Guide," \$3.00; a practical treatise on "The Suspension of Carriages," "Bookkeeping," and other carriage building works.

WHAT IT IS**The American Harness and Saddlery Directory**

The 1914 Edition

An extra painstaking revision of the names (and other information as below) constituting the Retail Harness Trade, has been completed for this year's issue of the Directory, and we think the work is so important and worthy that the

1914 Price Is \$5 Per Copy

and it is very moderate for what is offered in a work that is

Indispensable for Reference

for copying of addresses, and for all purposes usual in a directory.

Just a Sketch of Its Contents

The list of the **WHOLESALE** and **JOBGING TRADE** is so arranged as to make it convenient to separate the association members from those not so recognized.

The **RETAIL HARNESS MAKERS** of the United States and Canada comprise the principal part of the Directory, arranged by State, Town and County, and in the large cities, the street and number is given. Those rating (approximately) over \$1,000 are marked.

A list of **HARNESS DEALERS** as distinguished from retail harness manufacturers, is also given. The value of this list to those who solicit the vehicle, implement, hardware and department stores will be readily appreciated.

A list is also published of Export Commission Merchants, giving the class of merchandise they handle.

PUBLISHED BY

THE TRADE NEWS PUBLISHING COMPANY

PUBLISHERS OF "HARNESS"

24-26 MURRAY ST., NEW YORK

Quality
Is
Economy

The Varnish we used to call
Palest Motor Car Body Special
we now call, for special reasons,
Palest Motor Car Body

We called it *Special* while waiting
for Manufacturers to confirm
our judgment of its superior values.

Our judgment has been confirmed
in hundreds of Finishing Rooms.

Its *flowing* property is the greatest
ever.

It *saves enough time and labor* to
make it actually cheaper than varnish
at half the price.

It is absolutely dependable.
It avoids all uncertainties.
It is dead sure, every time.

One of our oldest and carefulest Salesmen
says: "I never heard such unanimous
nor such enthusiastic commendations
of any other Varnish."

Our mail gives the same impression.

The Varnish
That Lasts
Longest

Murphy Varnish Company

FRANKLIN MURPHY, President

Associated with Dougall Varnish Company, Limited,
Montreal, Canada

NEWARK
AND
CHICAGO

The Hub

Copyright, 1914, by the Trade News Publishing Co., of New York

Entered in the New York Post Office as Second-class Matter

Vol. LVI

OCTOBER, 1914

No. 7

THE TRADE NEWS PUBLISHING CO. OF N. Y. Publishers of THE HUB

J. H. WRIGHT, *President* G. A. TANNER, *Secretary and Treasurer*

24-26 MURRAY STREET, NEW YORK

Other Publications of Trade News Publishing Co.:

HARNESS (monthly).....per year, \$1.00
AMERICAN HARNESS AND SADDLERY
DIRECTORY (annual).....per copy, \$5.00

THE HUB is published monthly in the interest of employers and workmen connected with the manufacture of Carriages, Wagons, Sleighs, Automobiles and the Accessory trades, and also in the interest of Dealers.

Subscription price for the United States, Mexico, Cuba, Porto Rico, Guam, the Philippines, and the Hawaiian Islands, \$1.00, Canada, \$2.50, payable strictly in advance. Single copies, 25 cents. Remittances at risk of subscriber, unless by registered letter, or by draft, check, express or post-office order, payable to the order of THE TRADE NEWS PUBLISHING CO.

For advertising rates, apply to the Publishers. Advertisements must be acceptable in every respect. Copy for new advertisements must be received by the 25th of the preceding month, and requests to alter or discontinue advertisements must be received before the 12th day of the preceding month to insure attention in the following number. All communications must be accompanied by the full name and address of writer.

FOREIGN REPRESENTATIVES:

FRANCE—L. Dupont, publisher of *Le Guide des Carrossiers*, 78 Rue Boissiere, Paris. Subscription price, 15 francs, postpaid.

GERMANY—Gustave Miesen, Bohn a Rh. Subscription price, 12 marks, postpaid.

ENGLAND—Thomas Mattison, "Floriana," Hillside avenue, Bitterne Park, Southampton. Subscription price, 12 shillings, postpaid.

Entered in the New York Post Office as Second-class Matter

The Story of the Convention

First, the weather. It was as fine as spun gold. No rain, enough coolness to make getting around agreeable, and enough of the charm of October to make life worth living.

The attendance was an agreeable surprise. The locusts of pessimism justified their presence by the general business situation, but they turned into the butterflies of optimism when they saw how well the attendance responded to the call, all drawbacks considered.

If times had been normal this meeting would have been one to remember; as it was it proved a joyful occasion.

Atlantic City is a convenient gathering place for the builders of the South Atlantic seaboard states, and their presence was hoped for, but the state of the cotton market forbid. This situation was expressed to the eye as well as the mind by the several bales of cotton that exhibitors had brought and installed in spaces on the exhibit pier, and had them conspicuously labeled, "Buy a bale of cotton." One friend in the south sent a box of cotton bolls which were intended to be used as button-hole nosegays, and were so used. It will thus be remarked that all seemed to feel a very sympathetic interest for

those whom war and stagnation of business had kept from joining the company.

The arrangements for the convention and the meetings were better than at any previous time at this place, and this always tends to the happiness of the people.

The exhibits in number, variety and novelty were on a level with most forerunning shows, and in new ideas and displays showed a real step forward.

The meetings were more full of interest than usual, and the "Greek Temple," where they were held, was a testimony to this interest by the attendance always in evidence.

The plan pursued by the association of electing a new man for president annually is something of a handicap to those who bear the honor, and it is a very flattering testimonial to the kind of material the association has to draw upon that the incumbent can and does most always rise superior to such drawbacks, and presides in a most efficient manner. All that one wants to say that is nice and complimentary anent ex-president Roninger, may be uttered aloud, and with no contradiction. He conducted the proceedings in a manner as skillful as pleasing. As toastmaster he acted so well his part that the praise was general.

Very few are aware of the skillful, unremitting, yet tedious work to which the secretary of the association applies himself during the time from meeting to meeting to gather the features that make the meetings of value and interest. We doubt if those in closest touch with the workings of his office during the year have a full comprehension of the work. None of the "features" that are prepared bob up spontaneously; they have to be sought, even pursued, and the task is arduous. The same is likewise true of the banquet-speaking talent. It has to be hunted down, cajoled, persuaded and then rounded up.

In ye olden tyme there was little difficulty in the matter of speaking talent. Some of the best always had lightning rods aloft waiting to be flashed by a request to speak, but not so now. The Chautauqua idea seems to have put a market price on the spoken idea. As the association has never gotten to the point where it paid for its intellectual entertainment, it may be perceived that in this matter, also, the secretary has his work cut out for him in advance.

At this banquet the quality of the speaking was above par.

Speaking of the dinner, it was an epoch maker in one feature. It was the first time on record in the annals

of this association that women in attendance on the convention were guests at the banquet. This social feature has become somewhat the fad latterly, but the C. B. N. A. has always maintained a conservatism in favor of the old order of things, but it has finally yielded to what seems to be the rage for feminism, and the ladies are now in good standing, it would seem, and will have a place at future sittings as of right.

Another interesting development is the forcing of the total abstinence idea on the banqueters. There have been through the years sporadic attempts to abolish wine at the feasts, but with very indifferent results. It looks now as if the point would carry in the future, and subsequent banquets would be "dry."

Last year in St. Louis the Tuesday night function of the association was much elaborated. Heretofore this Tuesday evening reception has been a quite informal getting together to the end of better acquaintance; a little dancing, much standing around with conversation as the staple, and a wind-up with a collation and a little pink lemonade. In St. Louis, as said, the function bloomed into a very elaborate affair. The whirl was accelerated by hired talent whose mission was to start something every little while, and to keep the interest and enjoyment at highest pitch. Meanwhile there was a buffet lunch on tap all the time, and truly, "there was a scene of revelry by night."

Something of the kind was again in contemplation, but the stress of the times reduced the function to its old time democratic simplicity, which seemed to be all necessary for the happiness of the guests.

Aside from the allurements supplied by nature, the attractions of the boardwalk provided by man, and the general spirit of good will and good fellowship, the story of the convention is told.

The Accessory Meeting

The Accessory Trade, as all know, has its own side show.

At first, this meeting was only as a ways and means committee for raising funds from the associate membership of the C. B. N. A. to help finance the expense of a meeting in some of its particulars. But a few earnest crusaders amplified the plan into an organization that was accessory only in name, and was to include all who contributed to a fund, whether allied with the C. B. N. A. or not.

Probably most of the members (!) regard the contribution feature as the only feature, and when that has been done, interest seems to stop right there.

The meetings, which are held on a designated day in the week, are annual, also, and sometimes as many as a double baker's dozen foregather to talk over things. There are enough exhibitors on the ground to make a large meeting of it, but about the same few earnest souls get together, reelect themselves to the seats of the mighty, pass a resolution or two, and the performance is over for a year.

At the meeting this year the banquet wine prohibition

resolution was prepared, cooked and served, and it is this resolution that will be brought to the attention of the C. B. N. A. on another occasion, and most probably agreeably accepted and passed.

It is of curious interest to speculate what would have happened to the resolution of the earnest souls, if there had been a really representative meeting of associate members, in place of the double baker's dozen of the faithful old guard. There is a wide, shall we say, liberality of thought, on such a subject among the actually representative membership, and it would be interesting to have had a record that stood for the real opinion.

The C. H. A. T.

The C. H. A. T. (Carriage, Harness and Accessory Traveling Salesmen's Association) once more was a welcome visitor during the term of the C. B. N. A. convention at Atlantic City.

This society of earnest good fellows, mostly composed of traveling salesmen, is doing a splendid and altruistic work in the interest of all salesmen identified with the trades characterized.

The happy idea of meeting at a time when the bosses are in the spot light has been agreeable in its results.

The banquet (shore dinner) given for members and guests, was the Wednesday night feature in the Marlborough-Blenheim. It was informal, and yet dignified. Again the ladies were favored guests, and were the feature of color and charm.

The speakers were guests from the C. B. N. A., journalists of the trades, and its own members. It is no disparagement to the other speakers to say that its own members could have worn the laurels, if the courtesy of hospitality would have permitted.

Publicity

The C. B. N. A. has the habit of appointing a Committee on Publicity, and it is straightway filled up with the names of the trade journal representatives whose journals are identified with the trade.

Ordinarily this is a paper committee—a complimentary function—because there has never been any time work, and on most occasions, no work at all that had any publicity effect.

Last year the chairman of the committee, who is a very busy man at convention time, devised the clever idea of pitchforking the whole thing onto the C. B. N. A. itself through the office of a hired man who was to do the work. It worked, and possibly the man worked.

This year the publishers had a little meeting, the outcome of which was a publisher's publicity organization, of which Mr. A. M. Ware, of the Carriage Monthly, accepted the chairmanship, and it is proposed to make of this publicity idea something militant.

The chairman of this committee is elected without bounds as to time of office, and it is intended to organize a publicity bureau in the interests of the carriage builder, and of the association, that shall be on the job during

the entire year, and accomplish something worth while for the interest.

This is the first time an organized movement has been proposed, and if the executive committee of the association adopts the suggestions that will be laid before it at its session in November, we believe the C. B. N. A. will be able in the future to point backward to one year at least when the name of the buggy, the fame of the horse, and the work of the association will be known in the land to more than thousands of people, and for practically a pittance of expenditure.

The press will give substantially and generously of its time and ability for the work, and the trade will, we think, have reason to be grateful, even proud, of its allies.

A Warranty

We are surprised to learn that a journal representing implement dealers advances the opinion that an article of merchandise sold without stipulation from its maker is equivalent to being fully warranted by the laws of some states, and is likely to be so considered by the opinions of judges of courts in other states.

The committee on "abuses in the carriage and accessory trades" has reported to the C. B. N. A. that it would be politic and sensible to abandon the vehicle warranty. It recommended to omit it from printed matter in future. This is probably what will happen.

The buggy manufacturer maintains he has been pretty regularly the victim, through the vehicle dealer and his client, of absurd damage claims. In private conversation "absurd" is substituted by another word or phrase that is still different in its application.

The journal speaking for the dealers seems to think that an absence of warranty may make the dealer lukewarm in his buggy-selling efforts. Probably the dealer will be energetic according to the stimulation induced by the amount of the margin of profit. That is a cleaner way to get a profit than through replacement of alleged defects, or by allowance therefor.

AUTOMOBILE TRUCK CONVENTION IN DETROIT

The four-day convention of motor truck manufacturers, dealers and owners conducted by the Motor Truck Club of America, came to a successful conclusion in Detroit, October 10. Three hundred registered delegates from the truck and accessory industries were present.

Upwards of 50 different truck makers were represented, the tire makers producing truck tires were on hand. The United States government sent its official representative to assist in the work and invite the Motor Truck Club to hold its 1915 convention at San Francisco during the exposition.

Thirty-four papers were presented. These papers began with service to truck owners, which were handled by both dealers and manufacturers. Tire problems were handled by three representatives of the tire industry. Two papers were presented on the question of time payments for trucks. Charges for demonstrations in making truck sales; traffic engineering; parts to be carried in stock by dealers; the use of trucks on farms, and a score of other papers were on the calendar and discussed at length. All six sessions were well attended.

Many of the makers had made up their minds that if they attended a truck convention they must immediately form some sort of organization. A caucus was held which was attended by over a score of truck makers who are not members of any organization. Many favored a national truck organization rather than joining with the present national organization, the National Automobile Chamber of Commerce, which counts in its membership 33 truck makers and which has a special committee for commercial vehicle work. A committee was formed to report on the subject.

The sentiment was apparent that there has not been enough of the "get together" spirit in the truck field, and that the National Automobile Chamber of Commerce has been devoting more attention to the passenger car industry than to the truck field. Many of the truck makers present expressed a desire that this national body attack the existing evils in the truck field more vigorously and that it take immediate steps to largely increase its membership.

The framers of the program for the convention had aimed at featuring those topics that had to do with the merchandising and maintenance of motor trucks rather than matters relating to the manufacture of them and the engineering problems entering into their makeup, and it was this practical aspect of merchandising as well as the bugaboo of service that called for the longest discussions in the convention which has just come to a close.

THE DU PONT POWDER FUSE

Mr. Elbert Hubbard in *The Fra* (his own magazine of light and leading), takes up the cudgels against Harper's Weekly and Norman Haggood, its boss, in true Philistine style, to the extent of five and three-quarter pages, in review of the attack made by Harper's on the du Pont powder interests.

The Hub gave the gist of the story when it was current, so readers, we suppose, call it to mind. Mr. Hubbard goes more into detail, with especial accent on tail, but it is the editor of Harper's who knows how it feels.

SPLENDID! GRAND!

Elbert Hubbard speaks of the power and worth of the organization of advertising agents known as the Federated Advertising Clubs of the World as an "influence for good beyond human imagination."

This being—take it from Elbert—the fact, how is anyone to comprehend how good the goodness is? All we have is human imagination, and that is surpassed, it seems.

WUXTRY! THE CO-OP

The Firestone people (to spell it out and write Firestone Tire and Rubber is like telling the life history of a public man every time his name is mentioned, as a kind of identification), have a real newspaper named the Co-Op. Real newspaper make-up, real (Firestone) news, real pep., real good reading. Maybe a copy will be sent you if you ask.

CARRIAGE MAKERS' CLUB BUYS COTTON

At a meeting of the Cincinnati Carriage Makers' Club the evening of October 8, an appropriation of \$1,000 was made for the purchase of cotton to aid the Buy-a-Bale movement. A banquet preceded the meeting, Walter Brunsmann presiding.

CONVENTION ATTENDANCE

The register of attendance at the C. B. N. A. convention at Atlantic City was very nearly equal in number to the St. Louis registration. This is noteworthy in view of the handicap of "conditions," the talk of which was so pervasive.



Members of the Carriage Builders' National Association



the Atlantic City Convention, September 28-October 2, 1914

The Builder's Own Choice of His Best Style

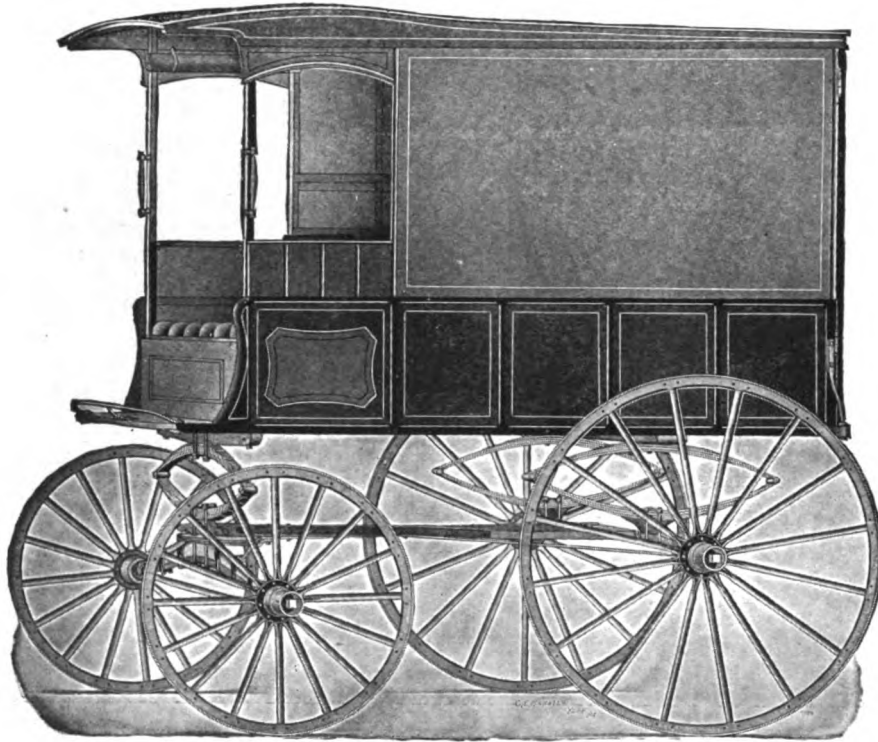

DELIVERY WAGON
Built by York Carriage Co., York, Pa.

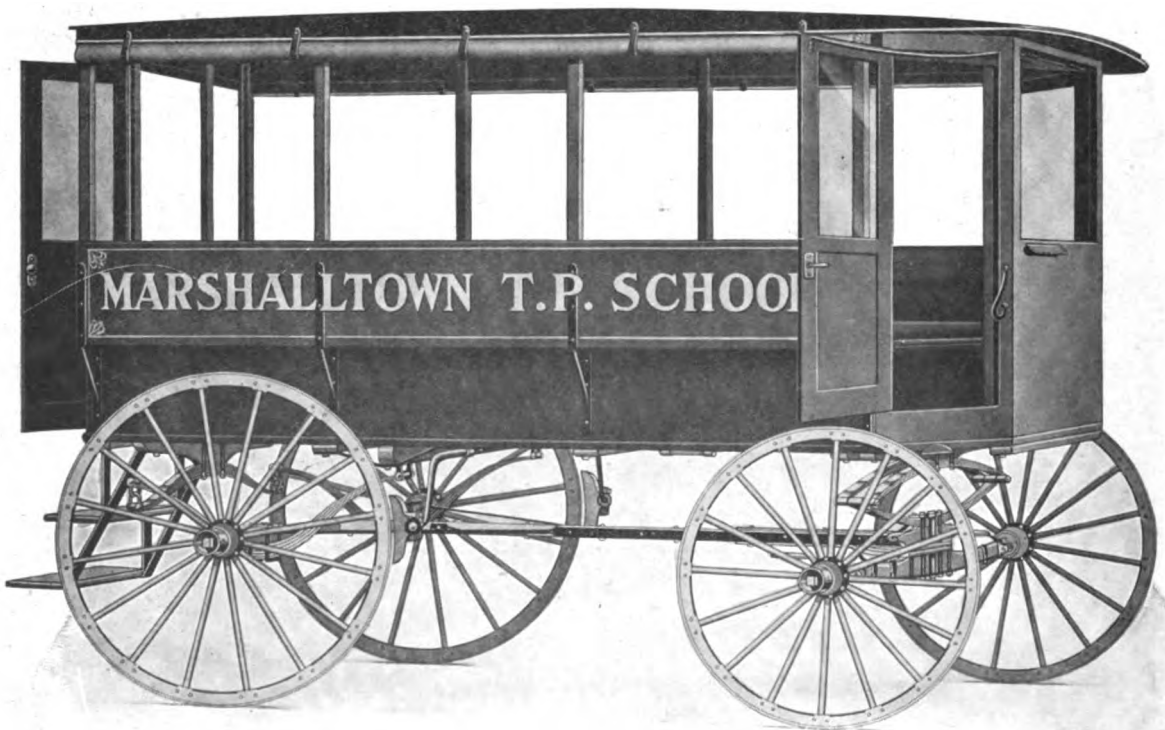

SCHOOL WAGON
Built by Marshalltown Buggy Co., Marshalltown, Ia.



COVERED SLEIGH

Built by Sturtevant-Larrabee Co., Binghamton, N. Y.

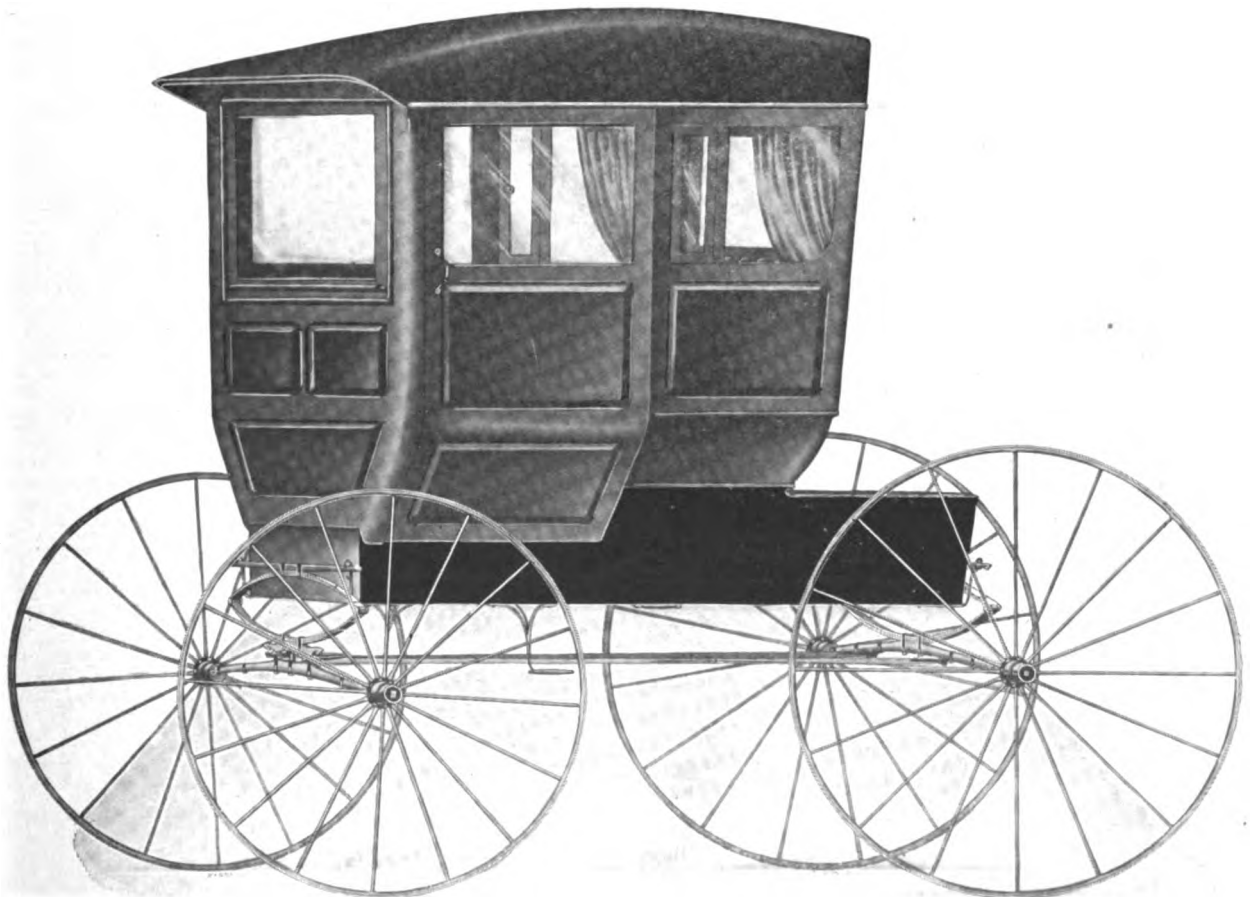

STORM BUGGY

Built by Fehring Carriage Co., Columbus, Ind.

Forty-second Annual Convention

Carriage Builders' Nat'l Assn.

Held at Atlantic City, N. J., September 28 to October 2, 1914

City of Cleveland, O., selected for next convention in 1915

The forty-second annual convention of the Carriage Builders' National Association met in the Greek Temple, Young's Million Dollar Pier, Tuesday morning, September 29, at 10 o'clock. The program was opened by a song by the male quartette, after which President William H. Roninger, of St. Louis, called the meeting to order. He said:

President Roninger: It gives me great pleasure to call this, the forty-second annual convention of this association, to order for the conduct of business such as will come before this meeting. Two years ago we met here in this, probably the greatest and best known pleasure resort in the world—not only a pleasure resort, but a convention city, where delegates to conventions are made comfortable and happy—in fact they make that their business here, and they do their work well—so well that this is the third time they have had our convention in the past four years, and personally I am glad of it.

We had on the program this morning an address of welcome by the Mayor of Atlantic City. Unfortunately he has been called to New York City this morning and we will have to forego that pleasure.

President's Address

It is usual on an occasion of this kind for the president to make an address, but as the time is a little short, and as I am not very much of a speaker, I am going to cut my speech short.

We are gathered together here in this convention hall once more, and as I look around me I am much gratified by the interest taken in this, our forty-second annual convention. As I said, I am sorry there are not more carriage manufacturers here, but considering the time it is very gratifying that the carriage manufacturers are so well represented. We have passed through a very strenuous year, not only in the carriage business, but in all lines of business there has been a general depression and a general curtailing—and it is not at all surprising that some few of our good members are not present. However, it is a grand thing to get together and talk things over. The general consensus of opinion by manufacturers in varied industries is that the coming season will be good—that things will open up. As I have said it is a grand thing to get together once a year and meet our friends and throw off our heavy business cares for two or three days—be sociable, talk things over, and find out that we alone do not have all the troubles.

The Freight and Classification Committee have, as usual, done good work. And in my opinion this is one of the most important committees we have. I do not know how you carriage manufacturers give this your thought, that is, the good work this committee is doing. We also have a Cost Committee, many times worth the cost of our yearly dues. You will hear the report of this committee in a few minutes.

We have great faith in the horse-drawn vehicle industry. In 1913, if you will remember, we built nearly one and one-quarter million horse-drawn vehicles, and we sold them. We have a population now of nearly one hundred and nine million people. At this rate in five years we will have a population close on to one hundred and twenty million. The farms throughout the United States are growing smaller. In a few years there will be very few one thousand or five hundred acre farms. The large farms are disappearing and in their place 100 acre, 50 acre, and 25 acre farms are appearing.

Settlers from European countries from now on will be flocking in here by the thousand—and we will get a good class of settlers. There is every reason why good thrifty farmers from France, Germany, Belgium and army-ridden Europe should locate in a free country. Now, what is going to happen? They must have horses, and if they have horses they will have horse-drawn vehicles, regardless of any other vehicles which may be put on the market.

Now, I believe that we cannot sit still on our oars. On account of the drought we had early in the spring, business conditions were not so good in our lines, but there is no reason why we should not have a good season in 1915 if we will only sit steady in the boat.

Some people say the horse is disappearing. The government report—that is, your Uncle Sam's report, says that the total number of horses in the United States, January 1, 1914, was nearly 20,000,000—with a valuation of nearly \$3,000,000,000. An increase over 1912 of nearly 400,000. That does not look as though the horse was relegated to the rear as some would have us believe. There is room for all classes of vehicles.

Regarding advertising, we have taken that up in our association, but unfortunately our advertising committee has not been able to do much work this year because of the lack of funds. It requires money to start an advertising campaign.

I am glad to say our secretary, H. C. McLear, has started an advertising campaign. It is marvelous what he has done within the last three weeks.

This association has had more advertising during this time than it has ever had in all the years that have gone by.

I do not want to overlook the good and watchful work of our grand secretary, Mr. McLear, whom I want to thank for his great help during the past year. He has done all the work—I have had all the glory. You who think that this convention just kind of happens have another thought coming—because it requires a great deal of work to get this convention together, and to make it interesting. This is all his work and he has made it possible to have this wonderful gathering here today. I want to say to you right here that his is no easy job.

Now, getting back to business: Business conditions have not been good. Notwithstanding the enormous crops there has been a feeling of discontent. Probably during the early months of this year, on account of the uncertainty of the workings of the new tariff—the new laws regarding trusts—the new reserve banking laws, etc. And just as soon as things were commencing to look good they started the uncalled for war in Europe. This is the time for all of us to get down on our knees and thank God that we are Americans (Applause), that there is nothing so good in all the war poetry as "The Star Spangled Banner" (Applause); and while the President really has the power to declare war, yet it takes a two-thirds vote of Congress—and all the people have something to say. It would not be possible in this country for one ruler to declare war and get away with it, without the consent of the people.

Whatever the outcome of this war—no matter who may be the victor, nothing can ever repay the nations for the terrible price that will have to be paid for the conquest. The countless numbers of lives that have been sacrificed; the destruction and paralyzing of all enterprises; the magnificent cities destroyed and ruined—all brought about probably by jealousy and a desire for supremacy in the business world. Possibly those three little words, "Made in Germany," "Made in Sheffield" had a great deal to do with it.

It is said by those who are well posted in this matter that these countries necessarily will have to be set back in their progress 50 or 100 years, but we do not want to gloat over

this awful sacrifice. The United States will nevertheless profit; it cannot be otherwise; and we will be most prosperous in years to come, for the United States will have to supply the world with the necessities of life.

No matter what our politics may be—today, we all stand as true Americans and can only be thankful for the truly "Watchful Waiting" policy of our President, God bless him! It has been after all the right policy—and it is something of an honor to be a citizen of the only great country on earth that is not at war with another nation and killing our neighbors for the sake of conquest (Applause). And while this terrible war is going on—while they are exterminating our neighbors and their business—is it not possible that in a very short time New York may be the greatest financial center of the world? Applause. That this should come to us after one of the worst commercial seasons it is easy to prophesy who will have the prosperity.

And, in conclusion, let us hope that the true Christian spirit that prevails here will permeate Europe, and that once more the "King of Kings" and the "Prince of Peace"—who died upon the cross that we might understand, will appear to those who have the power, and show them that the Christian spirit in the United States is best for all mankind, after all. (Applause).

As the representative of the Mayor of Atlantic City has not appeared, we had as our next address, one by Mr. Adrian D. Joyce, of Cleveland, O., on "Modern Business Tendencies," but I received word from him a few days ago that he was very sick and would not be able to be with us. We have a man with us whom we would like to hear from; he is not second choice; he is the first man I asked, after the last convention, if he would not make an address to us at the opening session of this convention. He was not sure at that time whether or not he could be here. He is here, and ladies and gentlemen, I have the pleasure of calling on Mr. James F. Taylor, who will now address you.

Address of James F. Taylor

Mr. Taylor spoke in part as follows: I will say that it is with great diffidence that I endeavor to take the place of the one who was appointed to address you on this occasion, and I feel somewhat as if the chairman should have introduced me as a speaker introduced a guest of honor at a banquet, some time ago. The dinner was passed; the coffee had been drunk; the cigars were being smoked; the jokes were being passed about; and general hilarity was in the room when the toastmaster arose and said, "Gentlemen, as I think you have now enjoyed yourselves sufficiently, the speaker of the evening will now address you." (Applause and laughter).

On my arrival here, without any expectation at all of having any duty to perform, I was caught by your honorable secretary and advised that he had telegraphed the president that I would address you in the place of Mr. Joyce. I asked Mr. McLearn on what subject I should address the association. He said, "Take Mr. Joyce's subject, 'Tendencies of Modern Business.'" I said, "I don't like to take away what another man has prepared; maybe some other day he can make use of it much better than I could." Then he gave me a half dozen other subjects, none of which I knew anything about. To cover the subject of "Tendencies of Modern Business," let me give you an illustration—an incident that happened to a party who told me of it before I left home: A firm received an order from a customer. The firm writes back to the customer, "You have a bill now past due, when you pay that bill we will ship the order." The customer writes back to the firm, "Cancel the order; cannot wait that long"; and so, gentlemen, the tendency of modern business is put in that one simple expression, just for the present, the cancellation of orders; and that cancellation of orders has been brought to pass in our country because of the terrible conflict that has raged in Europe. I suppose it is necessary to say something in an address of this kind in regard to the war, and in doing so I will take the liberty of reading a little extract that I noticed in the paper here, from an address by President Butler, of the Columbia University. He says, "Mankind is back in the primeval forest, with the elemental brute passions finding a truly fiendish expression. The only apparent use of science is to enable men to kill other men more quickly and in greater number. The only apparent service of philosophy is to make the worse appear the better reason. The only apparent evidence of religion is the fact that divergence and impious appeals to a palpable pagan God, have led him, in perplexed distress to turn over the affairs of Europe to an active and singularly accomplished devil.

"What are we to think? Is science a sham? Is philosophy a pretense? Is religion a mere rumor? Are the long labors of scholars and statesmen to enthrone justice in the place of brute force in the world, all without effect?

"It seems pretty clear that no civilized people will ever again permit its government to enter into a competitive armament race. The time may not be very far distant when to be the

first moral power in the world will be a considerably greater distinction than to be the first military power, which latter goal is so constantly and so subtly urged on the people of the United States. How any one, not fit subject for a mad-house, can find in the awful events now happening in Europe a reason for increasing the military and naval establishments and expenditures of the United States is to me wholly inconceivable."

President Roninger: I am sure we have all enjoyed Mr. Taylor's address. The next order on our program is a paper by Mr. C. W. Shipley, of Cincinnati. I am informed he is unable to be present, but his address will be read.

Mr. Shipley's address was read as follows:

EXPORT TRADE

By C. W. Shipley, Cincinnati, O.

The president of the Carriage Builders' National Association has devoted himself so faithfully, during his membership, to the interests of his fellow craftsmen, that members of the association must find it difficult to refuse to support him in



President C. O. Wrenn

any way that presents itself. In consequence, his courteous request that I address this association had the force of a summons, and my effort to interest you follows.

In 1887 the carriage business was at the height of its early prosperity. Its captains of that date have, for the most part, passed to the Great Beyond, but it was as a pupil to some of these that I learned my first lessons in the carriage business.

The interest shown in export trade at that time was well represented by the establishment of a Canadian factory, and such effort for foreign trade in other directions as the demands of the home business allowed. The exporting of the American buggy was almost coincident with its sale here. To some, the question of exporting was of material interest, but few, apparently, felt any inclination to study the matter seriously.

Each of us has had orders from abroad which have come by chance, and which are as welcome and unexpected as a nice, ripe grape fruit would be, sent to us for breakfast with the compliments of the hotel. These orders almost always come

from some commission house at the seaboard. Then follows the second step—a determination to go into the export business and get lots of these grape fruit orders. Perhaps the recipient of the order even goes to New York and consults the party from whom the order came, with the result that a lot of promiscuous advertising through the house in question is done. Then he sits down and waits for results. And in 99 per cent. of the cases we are still waiting for results, and the fault is whose? Our own. We have been waiting for someone to bring us grape fruit.

More harm has been done to the exporting side of our industry by the grape fruit orders than in any other one way, or, perhaps, in all other ways. Now, why is this? In the first place, the buyer's lack of technical knowledge leads him to order that which is ill adapted to his needs. In the second place, the builder's lack of knowledge as to the needs of the territory in question leads him to fill such orders unadvisedly; consequently, an order is filled and paid for, which, perhaps, is not worth the freight charges to the buyer. As a result, the whole industry is condemned, due, in part, to the misapprehension existing on the part of the seller that his goods are adapted to that country, and to almost every other country. I know from personal knowledge the kinds of roads and the character of the horses in a certain country, for which a lot of three-quarter inch light buggies were bought from a catalog house. In the first place, within the immediate town limits, the roads were of a rough cobble stone, dignified by the name of street, while outside, they were little more than mountain trails. The horses were broken to two alternatives only—to go ahead, or to stand still, when they could not move otherwise. The horses were not trained to back, and, in fact, had scarcely any training at all. Imagine driving these horses hitched to a three-quarter wheel Brewster side bar buggy. The buyer settled for the buggies, paid the freight, and also the custom house charges. Then the buggies were dismantled, and the parts used for various purposes. Is it to be wondered that at that place the American buggy was discredited?

Trade in the American buggy in India was ruined, and American vehicles permanently discredited as a whole, because, in sending vehicles there originally, orders were ignorantly filled. I say this advisedly, although I know some vehicles have been shipped into India.

In many cases, our friends in the trade who long ago felt the electric shock of the first order, are waiting still for further orders, because they filled incorrectly the first order. You can't ship a plow to a man who wants a piano; you can't sell in Labrador, a machine for spraying orange trees; and you can't expect results if you sell to a man in the Pampas of South America a three-quarter Brewster side bar buggy, when he really needs an ox-cart or a burrow.

Now as to export trade. The subject is mentioned in our papers every day. That's where we get the balance of trade the papers say; that is one of the sources from which we replenish our gold supply; there's not only millions in it, but there's billions, so why not let me have my share.

We will all have some export business, handed to us like a complimentary grape fruit, because of the nature of things; for anything more than this we must prepare, plan, work hard, work intelligently, and work persistently. Just think for a moment of the people who sent those Brewster buggies, got the money, and kept it. They hurt us all. They had no moral right to send those goods "without thinking." They didn't take the pains to think, and wherever they followed this practice they killed themselves and maimed the rest of us.

Are you willing to lay in a large stock of goods that you can use only in the export trade? How many 58-inch wheels, 1¼ inch tread, 13 and 17 flange can you use in the United States? How many 1¼ and 1½ inch coached axles will you use? How many carts made to drive with two horses will you sell in this country in the course of a year? Are you willing to lay in a stock of bodies, none of which can be sold in the United States, and carry them exclusively for your foreign trade? Are you familiar with the dimensions and the strength required in building these special bodies? In other words, are you prepared to carry a large stock exclusively for export trade, and to learn what should go to each country, and to refuse to sell that which should not go, even though you have the orders in hand? You must, of course, sell these goods, and you must keep the sales coming, else your shelves will be burdened with goods that do not move, except sometimes—to the furnace. We have discarded more styles than we have retained, more kinds of styles. I don't mean as we change a buggy from season to season; I mean radical change. At one time, when the gold rush was on, a demand existed for camping carriages. We made one where the layback of the front seat laid down between the two seats and made part of the bed. The last of these very properly went to the furnace.

You are in the carriage business, you issue catalogs showing 40 to 100 pages of different styles. Why do you do it? To

give the buyer a chance to choose, to show that you are in that kind of a business. It's the same way abroad. You can't induce a sale unless you have a variety to offer, and that means the keeping in stock of a large quantity of goods for prompt shipment, which you try to move as often as possible.

I find among our papers an old catalog, printed 30 years ago in English, Portuguese, and Spanish, showing carts—village carts we called them before the day of the cheap cart. Little business came from this catalog, however, for several good reasons. In the first place, the demand abroad for our vehicles has never been large, and it has been satisfied not only by concerns in the United States, but also by Canadian and foreign houses; furthermore, little real salesmanship has been exercised in seeking what trade there is. Results will never be different until we take the necessary steps to build up our foreign trade.

How many of us are familiar with the typical Philippine cart? How many of us have sent our salesmen to Australia, to Mexico, or to the islands of the Red Sea? How many of us have exploited our wares in the haciendas of Latin America, as the plow men have done and are doing? Have we sent our experts to study the characteristics of Mexico, Colombia and Brazil as the windmill men have done? Have we sent our experts to the wheat growing districts of the world as one of the large, successful, independent harvesting concerns of Australia did, with the result that it is today fighting successfully the great harvester trust of America? Can you describe the policy of Venezuela regarding its traffic, or tell us where we can put our hands on such information? Are you wasting your literature by sending it where the post office authorities will not allow it to enter? Did you know that there were such countries? These are some of the questions that must be considered in connection with export trade. Export Trade sounds big and sounds easy. Well, if you think that it is so, it's you that's easy.

If you want export trade, go to school and learn the A B C. Get all the grape fruit you can, of course, but understand, that isn't export trade, that's the god of chance, and remember, lightning rarely strikes the same place twice. What you must do, however, is to get into the position to deserve export trade and then work hard for it. Try not so much to divide the trade existing as to develop additional trade, so that your share will be an addition and not a sub-division, a proceeding that I know is really possible. Five thousand miles from home, I secured a new job by sketching with chalk on the board floor of a warehouse a certain model, not necessarily a new style, perhaps only a modification, perhaps a development of a local style, but every one of that model which sold was a sale that would not otherwise have been made. Thus the man who is entitled to export trade must qualify; the man who receives the grape fruit order and waits is the piker.

A great difference of opinion exists as to the fairness and wisdom of trading direct, or through a commission house. This is a subject that has been treated exhaustively, but has never been settled. My own view is, that we are all human and have the right to look out for our own interests, so long as we do not infringe on the rights of others. If your commission house establishes business for you, and if it pays the expense of establishing this business, it is only fair to continue the business through such house. If the commission house acts simply as banker and agent in handling the business which you develop, it has no ownership in the business. Many of the commission houses are the agents and buyers of houses abroad, and the business of these foreign houses, whether or not you develop it, comes through these houses which act as buyers and bankers. Many of the large foreign buyers, however, are establishing relations direct with the manufacturers, striving, in this way, to save the intermediary charges. The building up of the large forwarding houses at the seaboard is an outgrowth of this idea.

The question of terms is one constantly discussed. If we must have cash on delivery seaboard, someone must be banker. The delivered cost of the goods carries the charges, and it's the delivered cost of the goods that interests the buyer; he does not care when paying \$150 for a job at Bombay, whether the job cost \$100 or \$125 at the factory. If you can save money in delivery, you can put the saving in your own pocket, or allow your customer to get his goods cheaper. Many goods are sold at ridiculously low cost here, but on account of careless handling in boxing, in inland and ocean freights, in forwarding and banking charges the delivered prices becomes excessive. In such a case the manufacturers make little and the buyers pay too much, all due to the ignorance or carelessness of the seller.

But as to terms strictly. I think the only basis for their consideration is the same basis that you use in domestic business. The foreign buyer is just as honorable and worthy of credit as the domestic buyer. We have many times opened a credit for a small amount even with very slight warrant for extending it, and have seldom lost by it. This is not wild-cat business, but is a definite policy based on the well known fact that, if we expect to have any standing, our goods must be our

one best advertisement. If we can, by such risk, display a job in a new port, and it serves a good purpose, we have advertised both our own vehicle and American vehicles, and we know that it has been the goods themselves that have resulted in business. I might say, in this connection, that it is not our experience that foreign buyers interest themselves in goods sold only on price. The foreign import merchant is trained to make every effort to hold his trade, and to do this he must have good goods at a reasonable price. The result is a three cornered, lasting arrangement—manufacturer, importer, consumer. Supply, therefore, only such goods as will give satisfaction.

Do not make the mistake of thinking that you will have a second chance, for if your goods fail the first time, even though your price was a sacrifice one, you are out, confidence is gone. It is for this reason that a trade mark on good goods is so much more valuable and necessary abroad than at home. You must, of course, be very careful not to infringe on someone's else trade mark, for infringement, in some countries, is punishable by fines and by the confiscation of the goods. An instance of the importance of a distinctive trade mark is as follows: A shipload of binder twine went to a foreign port with the manufacturer's usual trade mark on it. The buyer was horrified to learn this, as the trade mark was a simple, everyday emblem in use on other goods in his country. He stopped the ship outside the custom's limit and overhauled every ball of twine, removing the trade mark. This regulation had led to the piracy of trade marks, so that many American, English and German trade marks have been registered in foreign countries by sharks having no ownership or interest in them, but simply desire to blackmail their legitimate owners. The spread-eagle style of description we so much enjoy helps to fill the foreign waste basket. Do you really think it helps to say: "The largest and best factory on earth"; "The best buggy ever built"; "Every wheel made from split hickory"? Confine your statements to real facts and to careful and accurate technical description. Write a little longer letter than usual and remember how far away your customer is; an expression of courteous respect to one from whom you seek business is appreciated. In this same list are your advertisements; they should be attractive, written in the language of the buyer by one familiar with its idioms. How many of our advertisements have condemned the seller! Would you want to describe "The Water of Life," as it is used in the New Testament in referring to Christ, as "Whiskey"? Well, a literal translation of "The Water of Life" in a foreign tongue is the name for whiskey, and I have known a raw translation to become obscene, due simply to the translators' ignorance of idioms; such things make the seller ridiculous and nothing kills quicker than ridicule.

The United States government in its proper departments has done good and intelligent work, and these departments deserve much greater support than Congress has given them, but much is left for the government to do. The advent of the United States in the foreign field is so recent that the organization necessary to supply real information must grow.

The State Department recently sent through the country a mass of consular reports regarding the trade abroad in carriages. These reports, however, were of little help as a basis on which to establish or develop a trade in vehicles. The information was largely regarding styles now obsolete, which prevailed during the prosperity of the trade in high priced vehicles. On the whole, however, the completeness of the reports, considering the means at hand, is surprising. Many of the consular reports are accurate and complete, and may be obtained upon request from the Department of Foreign and Domestic Commerce.

But why should Congress have been so niggardly in dealing with its departments for the development of foreign trade? Compare the appropriation for the support of the Department of Agriculture with the expenditures for the development and support of foreign trade.

Report of the Secretary of Agriculture—1913

Page 5. For ordinary expenses.....	\$16,651,496.00
Special appropriations, etc.....	8,303,412.68
<hr/>	
Total available	\$24,954,908.68
Page 6. Appropriations only indirectly affecting agriculture, approximately	\$15,000,000.00
Available for work directly affecting the farmer	9,000,000.00
Increase in appropriations recommended for this purpose.....	1,074,387.00

From the Congressional Records, Document 337

Consulates and Agencies, total expenditures year ending June 30, 1913 (page 53).....	\$1,972,604.39
Total receipts from same.....	1,852,535.99
Net cost of service.....	120,068.40

Under date of July 9, 1914, A. L. Thurman, Acting Secretary

of State, in a letter to Congressman Stanley E. Bowdle, states as follows:

"Congress has made no specific appropriations under the Department of Commerce for the development or support of the foreign trade of the United States during the fiscal year, 1914. The moneys used by this department for the development of foreign trade are those appropriated for the support of the Bureau of Foreign and Domestic Commerce.

Salaries, Bureau of Foreign and Domestic Commerce.....	\$104,860.00
Collating Tariffs of Foreign Countries.....	10,000.00
Promoting and Developing the Foreign and Domestic Commerce of the United States.....	60,000.00

A comparison of the above figures and statements develops the following facts:

First—That the entire cost of the consulates and agencies of the United States for the year ending June 30, 1913, was directly charged against the foreign trade of the United States, except \$120,068.40.

Second—That Congress has made no appropriations for the development or support of the foreign trade of the United States during the fiscal year 1914, and any moneys used for this purpose were taken from an appropriation of \$174,860—the amount set aside for the support of the Bureau of Foreign and Domestic Commerce.

Third—That the appropriation at the disposal of the Secretary of Agriculture is practically \$25,000,000; for work directly affecting the farmer \$9,000,000.

We are urged to seek export business at the present time as never before, and the ease with which it can be obtained is held up to us by the daily and trade papers, and by the commerce and trade organizations. I wish to dwell, however, on the situation as it exists in South America at the present time, and to urge assistance on the part of all those who are encouraging an effort to build up foreign trade in that direction. Permanent business in South America can be established only by the same consistent effort that is made to establish business in the United States. Collective work will result in no greater benefits there than in the United States.

South America has, with the exception of such articles as nitrate, coffee, rubber and tropical products, practically no products to dispose of except what she raises, of which we ourselves are exporters. It is necessary that South America sell her productions in order to pay for what she wishes to purchase. Since Europe has been South America's customer for the largest part of her product, South America will be in no position to buy our merchandise and pay for it until she has found a place in which to market her production. That this phase of the situation is not realized as it should be, is illustrated by the fact that the published statements urging the United States to step into the European situation, and supply the goods demanded by South America, make no mention of the means by which South America can pay for these goods. In the discussion of the merchant marine, designed to carry goods to South America, the fact seems to have been entirely overlooked that unless the United States becomes a buyer of South American products, her ships would return empty.

There is no question but that some few individuals, firms, or otherwise, may market their goods at the present time in South America, but this does not change the facts with reference to the situation as a whole.

The temporary disarrangement of relations between South America and Europe as mutual buyers of each other's products will only become permanent to the extent that the United States, either directly or indirectly, becomes the purchaser of the products of South America.

The great assistance, in this emergency, that we can be to South America, and the way for us to increase our trade there, is to make possible the sale of her products here, and now. In this manner we shall be able to make sales now and retain her merchants as our friends at least, and to some degree our customers when normal conditions return, and trade balances readjust themselves. For the present, the merchants of South America are in a state of paralysis; both as buyers and sellers, they have been shut off from their markets.

It seems to me, that any great effort or expenditure at the present time, with the hope of immediate results in South American business, is absolutely futile until South America has arranged for the disposal of her products; for it must be remembered that South America has no assets free with which to pay for current purchases. It must also be remembered that South America is a debtor country, and largely indebted to Europe for previously contracted debts, interest, maturity of capital investments and loans, and for purchases made and not liquidated.

Nothing visionary or theoretical should enter into a consideration of this problem, but the facts should be looked squarely in the face. And you may be sure of this, that the merchants of South America will require definite knowledge as to our

attitude as buyers before they will be in a position or willing to buy from us.

President Roninger announced the next order of business would be the nomination of a president for the ensuing year.

Nomination for President

Mr. Luth: I have the honor and take great pleasure in nominating one of the oldest members of our association, who has been a very faithful member and who is one of the pioneers in the south in this business. I am sure he will make a fine president. He has always attended our meetings. I take pleasure in nominating Mr. C. O. Wrenn.

The nomination of Mr. Wrenn was seconded by Mr. J. D. Dort and also by Mr. Jas. F. Taylor, who moved that the nominations for the office close. Carried.

Mr. Wrenn thanked the association for the compliment shown him.

Secretary McLear stated that invitations had been received from the following cities for the association to meet at the respective places the following year: New York, Chicago, Isle of Palms, Charleston, S. C.; Chattanooga, Tenn.; Columbus, O.; Galveston, Tex.; Oakland, Cal.; Springfield, Mass.; Panama Exposition, San Francisco; New Orleans; Toledo, O.; Buffalo, N. Y.; Cleveland, O.; and Baltimore, Md.

Mr. Bannister offered the following resolution:

Resolved, That the unprecedented condition existing in the south country brought on by the fearful and disastrous European war, which has practically closed the avenue for the distribution of cotton, calls for the patriotic and substantial support of every American citizen;

Resolved, That it is the consensus of opinion of this association assembled in convention that every member should buy at least one bale of cotton, and by this act contribute to the relief of the situation.

Mr. H. B. Staver offered an amendment to the resolution that the price be put in at 10 cents.

President Roninger: I wish to say for the benefit of the members present that that move was started in the south and was taken up very strongly in St. Louis, and St. Louis has subscribed very liberally to the bale-of-cotton movement. One concern there subscribed for 2,000 bales. They have sold a great deal of cotton and it has made a difference in the market, and this movement will be a great help. The conditions are rather peculiar in this cotton business. Of course cotton could have been bought for less than 10 cents, but it is not a question of making money, but the question of getting a staple price. Most of the cotton we know is raised by a great many small farmers—cotton growers—20 bale men, who have their cotton mortgaged, sometimes six or eight months in advance and who have probably got it mortgaged at 10 cents a pound. That is the reason the price has been put at 10 cents a pound. It is a very good move.

The president then appointed the following committees:

Committee on Resolution—O. B. Bannister, Charles E. Adams, Homer McDaniel, C. E. M. Champ.

Committee to Recommend Officers for Ensuing Year—Theodore Luth, J. D. Craft, W. E. Maxwell, P. E. Ebrenz, J. M. Yeakle.

Obituary Committee—James F. Taylor, O. B. Bannister, B. W. Straus.

Committee on Exhibits—Thompson Price, Harry N. Hill, William A. Snyder, W. A. Sayers.

Report of the Executive Committee

Mr. Ebrenz, chairman of the Executive Committee, read the report of that committee as follows:

Gentlemen: In presenting the report of the Executive Committee for the forty-second annual meeting of the Carriage Builders' National Association, your committee extends thanks for the loyal support of its many members during the past year, and is very glad to be able to say the association was never in a better financial condition than at the present moment.

While the condition of the general business of the country has not been as good this year as in 1913, still from the observation of your committee we judge all of our members have met with fair success in their efforts to conduct a profitable business along the latest ideas.

With the constant effort that our committees have put forth we are pleased to report that our membership is increasing and the work of the association is being extended, making it more valuable to every manufacturer in our industry.

It would be very pleasing to your executive committee to have every member of the association show interest in our efforts, and during the year take up important matters with some member of the committee or our worthy secretary, which can be acted upon either at our annual convention or at the meeting of the executive committee. If necessary your committee will hold special meetings to act on important matters which require immediate attention.

In these times of action do not let us fall behind on association work, which may be of vital importance to some manufacturer, and of great benefit to him during the year.

Such efforts as have been made during the past year by your committee in the way of a general advertising of the horse-drawn vehicle industry, have been so satisfactory as to encourage your committee to continue the same character of advertising during the coming year.

There has been very interesting information obtained by our Statistical Committee, and we hope their report will be carefully noted.

Your Technical School is in very flourishing condition, and well supported by funds to carry along a successful work among its many pupils.

The second edition of our Reference Book, where to buy carriage material, was favorably commented upon, and we hope has been useful to our members during the year.

In closing we extend to every member of this old association, the oldest trade organization in America, the very best wishes of your Executive Committee, and heartily solicit your co-operation for the welfare of the association in the future.

PHILIP EBRENZ, Chairman.

Secretary-Treasurer's Annual Report

H. C. McLear, Mount Vernon, N. Y.

The secretary and treasurer of the Carriage Builders' National Association of the United States submits his report from January 1, 1913, to the same date in 1914:

Cash in bank January 1, 1913.....	\$7,968.30
Received from dues, exhibition, interest, and banquet tickets	\$8,748.88
Received from contributions for the Technical School	1,625.00
Received from Associate Members Association	1,147.28
	\$11,521.16
Total Receipts	\$19,489.46
Expenses during same period—General and Regular	\$8,293.52
Invested by Investing Committee.....	6,000.00
Paid Trustees of the Technical School.....	2,038.72
Deposits in Banks.....	3,157.22
	\$19,489.46
Contributions for the Support of the Technical School.	
Automobile Chamber of Commerce.....	\$1,500.00
Mr. Charles J. Richter, chairman of the Board of Trustees of School.....	100.00
Highland Body Co., Cincinnati, O.....	10.00
Charles Abresh Co., Milwaukee, Wis.....	10.00
The Hoolbrock Co., New York.....	5.00
	\$1,625.00

In accordance with section 2 of the By-laws, which calls for the report of all new members enrolled during the year, I report the following:

Active

A. H. Ahlbrand, Ahlbrand Carriage Co., Seymour, Ind.
Fred Boettler, Fred Boettler Carriage Co., St. Louis, Mo.

Aug. Balter, 809 South First street, St. Louis, Mo.
 H. G. Borbein, H. G. Borbein Carriage Co., St. Louis, Mo.
 H. L. Burg, L. Burg Carriage Co., Dallas City, Ill.
 L. M. Browne, Columbus Buggy Co., Columbus, O.
 F. A. Baker, Emerson-Brantingham Co., Rockford, Ill.
 John Cook, John Cook Carriage Co., St. Louis, Mo.
 H. F. Cartwright, Banner Buggy Co., St. Louis, Mo.
 W. C. Durant, Republic Motor Co., New York.
 John Finck, 1600 South Jefferson avenue, St. Louis, Mo.
 M. R. Hull, Rex Buggy Co., Connersville, Ind.
 W. H. Houghton, Houghton Sulky Co., Marion, O.
 D. J. Keck, David J. Keck Carriage Co., St. Louis, Mo.
 Frank Krantz, Frank Krantz Carriage Co., St. Louis, Mo.
 W. T. Minor, Durham Buggy Co., Durham, N. C.
 James H. McCabe, McCabe & Powers Carriage Co., St. Louis.
 Louis Nicolaison, Nicolaison & Stuhr, Cheyenne, Wyo.
 Edward J. Powers, McCabe & Powers Carriage Co., St. Louis.
 Fred M. Roehlk, Roehlk Carriage Co., St. Louis, Mo.
 N. B. Schuster, Schuster Carriage Co., St. Louis, Mo.
 Wm. Schaefer, Wm. Schaefer Carriage Co., St. Louis, Mo.
 J. M. Selzer, J. M. Selzer Co., St. Louis, Mo.
 Wm. Stuhr, Nicolaison & Stuhr, Cheyenne, Wyo.
 Lanning F. Tidrick, Porter & Tidrick, Des Moines, Ia.
 Wm. A. F. Uhlenhaut, Uhlenhaut Bros. Carriage Co., St. Louis.
 C. S. Walker, Kratzer Carriage Co., Des Moines, Ia.
 Wm. Young, Wm. Young Carriage Co., St. Louis, Mo.

Associate

F. F. Anderson, Anderson Electric Machine Tool Co., St. Louis.
 J. Ander, Canadian Gear Works, Newcastle, New Brunswick, Canada.
 Joe F. Adkins, Owensboro Forging Co., Owensboro, Ky.
 W. S. Avis, St. Louis Surfacers and Paint Co., St. Louis, Mo.
 Bradley H. Parnes, Atwater Mfg. Co., Outhington, Conn.
 M. F. Bishop, Bishop Mfg. Co., Barrington, Ill.
 R. L. Brewer, Cortland Carriage Goods Co., Cortland, N. Y.
 M. S. Bottume, C. Cowles & Co., New Haven, Conn.
 F. P. D'Arcy, D'Arcy Spring Co., Kalamazoo, Mich.
 N. C. Cotabish, National Carbon Co., Cleveland, O.
 J. B. Childe, Western Spring and Axle Co., Cincinnati, O.
 S. R. Ewing, Owensboro Forging Co., Owensboro, Ky.
 M. F. Geserich, Forbes Varnish Co., St. Louis, Mo.
 Harold A. Holmes, Journal Company of Troy, N. Y.
 Ashton Hamilton, Wade Mfg. Co., Brockton, Mass.
 Jacob F. Haberer, Haberer & Co., Cincinnati, O.
 Wm. C. Klein, Ideal Lamp Co., Cincinnati, O.
 Marcus A. Leavey, Mexico City, Mexico.
 George McMaster, Mutual Wheel Co., Moline, Ill.
 Charles O. Mainor, Carriage Woodstock Co., Owensboro, Ky.
 James F. McBride, Edward Smith & Co., Long Island City, N. Y.
 Frederick R. Maddock, Edmund F. Heath & Son, Newark, N. J.
 A. J. Murray, Indiana Forging Co., Indianapolis, Ind.
 W. L. Wickamp, Beck & Corbit Iron Co., St. Louis, Mo.
 Thompson Price, Gregg Varnish Co., St. Louis, Mo.
 J. H. Redhead, National Malleable Castings Co., Cleveland, O.
 J. F. Reynolds, Ferrel Brake and Mfg. Co., Cleveland, O.
 Alfred M. Smith, Atwater Mfg. Co., Southington, Conn.
 John B. Stobacus, Sr., Keratol Company, Newark, N. J.
 R. X. Schumacher, Perfecto Light Co., Des Moines, Ia.
 N. N. Spear, Price Leather Co., Boston, Mass.
 Edward Trau, New Wapakoneta Wheel Co., Wapakoneta, O.
 George S. Weimer, F. A. Neider Co., Augusta, Ky.
 I. D. White, Clinton, Ind.
 Walter A. Zelnicker, W. A. Zelnicker Supply Co., St. Louis, Mo.

As far as has been reported to me or published in the various trade journals, there have been the following deaths among our membership during the past year:

Honorary

Rev. J. M. Norrell, Chaplain of the association since 1885, age 88.

Active

John M. Smith, Atlanta, Ga., December 13, 1913, age 84.

Associate

Thomas Boudren, Bridgeport, Conn., age 84.
 L. M. Fitch, Rome, N. Y., October 21, 1913, age 64.
 Wm. H. Son, Wilkes-Barre, Pa., November 30, 1913, age 50.
 Samuel K. Felton, Philadelphia, Pa., February 6, 1914, age 82.
 Clarence Heath, Shortsville, N. Y., April 5, 1914, age 57.
 C. E. Henry Stengel, Newark, N. J., April 19, 1914, age 56.
 William W. Eccles, Auburn, N. Y., August 16, 1914, age 43.
 R. N. Collins, St. Louis, Mo., age 55.

Mr. Boudren and Mr. Felton were not only among the oldest members of the association in years, but in point of service, as both had been members for over 30 years.

The association then took a recess to meet the next morning at 10 o'clock, Wednesday, September 30.

SECOND SESSION, WEDNESDAY, SEPTEMBER 30

The program was opened by a song from the quartette. President Roninger called the meeting to order, and announced the first number on the program would be an address by Mr. H. Collier Smith, of Detroit, on the subject, "Sheet Metal Work as Applied to the Horse-drawn Vehicle."

Mr. Smith addressed the association as follows on the subject:

SHEET METAL WORK AS APPLIED TO THE HORSE-DRAWN VEHICLE

Address by H. Collier Smith

I appreciate the honor of being invited to address this convention, not being a member of the Carriage Builders' Association. In order to not bore you any longer than possible I have condensed what I have to say and written it down, so we will not expend any more time than necessary.

Broadly speaking, we follow the line of least resistance in everything we do, which is not only natural, but almost inevitable. Necessity is the mother of invention, which saying can be interpreted to mean that as a rule we do our inventing or improving after feeling the necessity for it. These fundamental principles apply and are recognized the world over. We generally use the materials and other means at hand for accomplishing the purpose in view, thus following the line of least resistance, expending the minimum amount of energy and getting a concrete result in the shortest possible time, and it is because of these great fundamental laws which always have do now, and always will govern us, that horse-drawn vehicles have been made almost entirely of wood. Nature furnishes wood of various kinds grown to our hand; all we have to do is take it, and with comparatively little preliminary preparation it is ready for use in building vehicles or a thousand and one other articles, but the ever increasing demand for, and decreasing supply of wood has brought us to a point where we are beginning to get anxious about the supply and woodworkers in numerous lines of industry are investigating the possibilities of other materials as a substitute. In many cases, wood has been almost entirely displaced by metal. It takes a jolt of some kind, like scarcity or prohibitive advance in price, combined with an active demand to bring about a change of material in manufacturing a given article.

The automobile body is an illustration. When it became a fad to use automobiles and hundreds of thousands of people were anxious to dig down in their jeans and hand out millions of dollars for them, the manufacturers, of course, bent every effort to supply the demand, as there was no difficulty in selling machines, the problem being to produce them. The worst snag the body builders encountered was the practical impossibility of meeting the demand with wood paneled bodies, because both the supply and price of the wood panels, and the manufacturing methods necessary in using them were prohibitive, so they were forced to try some other material, and following the line of least resistance, they found that metal could be had in sheets of the proper thickness in unlimited quantities, at a low price; therefore, they began to use sheet metal, and by doing so were enabled to supply the immense demand at a much lower cost than it was ever before thought possible to produce bodies for.

In designing vehicles, either motor-driven or horse-drawn, utilitarian considerations govern the dimensions and general operating arrangement, but the nature of the material to be used largely governs the finished lines, so that when automobile bodies were made of wood as they were at first, the general lines of the body were such as could be most easily worked out in wood, but after metal came into general use, designs began to change, until now it is almost unnecessary to consider any particular shape or design with a view to the ease with which the material can be worked, thus leaving the designer almost fancy free. I am citing the automobile body because it is closely allied to horse-drawn vehicle bodies, and is built by concerns manufacturing both kinds of bodies, or who formerly were carriage builders, and furthermore, because the horse-drawn vehicle must inevitably follow, so far as the body construction is concerned, the course of the automobile body. I believe the main reason why sheet metal is not used in horse-drawn vehicle bodies is because there has been no sudden compelling necessity for doing so, as there was in the case of the automobile body, but the advantages of using metal in vehicle bodies are just as great as they are in automobile bodies.

I have encountered a diversity of opinion as to the use of sheet metal in vehicle bodies. An impression exists in the minds of some manufacturers that in order to use metal a big investment in immense presses and expensive dies is necessary, and that all the knowledge and skill implied by the use of such equipment must be acquired in order to turn out one set of

panels, or, at least, to get out work economically, which is, of course, a great mistake. As a matter of fact, comparatively inexpensive means have been developed and are in daily use by which with a very small outlay for equipment, one metal body of almost any kind can be made at considerably less cost than one similar body can be made for in wood, with the average woodworking equipment. This is a fact, not a theory. Often when hearing this objection as to the relative cost of one body or a small number of bodies when made in metal, I have asked whether they would favor metal construction provided one body could be made at the same cost in metal as it could be built for in wood, and almost invariably the answer was they would prefer metal in that case; in short, I gather from my investigations of the subject that the principal reason why sheet metal is not being used in horse-drawn vehicles today is that carriage and wagon builders have not seriously taken up the matter and are therefore uninformed as to the manifold advantages to be derived from using sheet metal in place of wood. To use sheet metal, additional equipment is necessary, as you cannot work metal with wood-working tools and machines, and of equal importance, is a knowledge of the nature of the metal itself, the various shapes into which it can be worked, and the methods of working it. This is all only a matter of a little study and experiment for which the student manufacturer will be amply repaid in reduced cost of construction and the refinement of design made possible by using sheet metal instead of wood.

The carriage builders I have talked with are practically unanimous in the statement that sheet metal is better than wood from the painter's point of view; it is lighter, stronger, more durable and superior in many ways. One of the objections I have heard to the use of metal in bodies having flat sides or panels is that it rumbles. The answer to this is that the metal used in bodies that rumble was probably buckled before it was put on the job; that is, the sheets were not properly leveled at the mill, and did not lie flat. The surest way to avoid rumbling is to avoid flat surfaces, so designing the body that every surface will be slightly curved, unless the surface is very narrow.

Another objection I have heard is that when a metal panel becomes damaged from collision there is no doing anything with it even though the dent is very slight. The answer to this is that those who make this objection, though first class wood workers, know nothing at all about working metal, as it has to be a very bad dent in a sheet metal panel that cannot be straightened out without destroying the panel, that even a new panel is usually a small matter. It is only a matter of knowing how, and it is so simple a matter that any young man of average intelligence, with a little instruction from an expert, quickly becomes expert himself; in fact, I believe that it takes less intelligence and skill to work sheet metal after the proper equipment is provided, than it does to work wood by hand, as it is worked by first class carriage builders.

A journeyman carriage builder must have a large chest of tools, expensive and of high quality. A journeyman sheet metal worker requires very few and inexpensive tools. The exact items of equipment for working sheet metal in the construction of horse-drawn vehicles vary to some extent with the type of vehicle to be made, whether it is desired to make closed carriages, open buggies, dump wagons, grocers' delivery wagons, and so on. An equipment that will be adequate for the average shop turning out the average product, comprises a shear for cutting irregular as well as straight parts, one or more beading, edging and wiring machines for rolling in moulding, turning edges and flanges, laying wires and rods in the edges of panels, and so on; a forming roll for forming simple curves, and one or more power hammers with necessary dies and attachments for shaping and polishing panels and doing various other operations. These machines and a few inexpensive hand tools and bench devices, stakes and formers, etc., combined with the necessary knowledge of how to work sheet metal, will enable the manufacturer of closed carriages, grocers' and delivery wagons, and any vehicle of light construction to use sheet metal where wood panels and canvas roofs were used before. If the volume of output is large, electric and oxy-acetylene welders are profitable.

For the manufacturer of ice wagons, dump wagons and other vehicles requiring a heavier gauge of metal than that used on the lighter vehicles, heavier machines of the same kind as that used on lighter work must be used, and in addition, a power punching machine is needed. If there is a considerable volume of output, pneumatic riveters will be found advantageous. For making buggy seats or other parts in large quantities at low cost, the right kind of power press provided with suitable dies is necessary, but the press and die method will not pay unless the parts are to be manufactured in enormous quantities.

[Mr. Smith here gave some lantern-slide views of vehicles and explained which parts could be made of metal, as well as some of the machines and tools used in the sheet metal construction of vehicle bodies as practiced under his methods].

I regret that time will not permit going further into detail as to how various horse-drawn vehicles can be constructed of metal, but I have endeavored to touch upon the main points in a general way, with the idea of stimulating interest in the subject, as I am convinced that it is only a question of time and a short time at that, when most of the carriage and wagon builders of the United States will be forced by economic conditions to give more or less consideration to the use of sheet metal in vehicle body building, and those of you who go at it first and master the simple principles involved, will reap the greatest benefit from the evolution.

President Roninger then introduced Mr. Louis H. Rogge, of Dayton, O., who addressed the association as follows on the subject of "Vehicle Advertising":

VEHICLE ADVERTISING

By Louis H. Rogge, Dayton, O.

Mr. President and fellow members of the Carriage Builders' National Association:

Your program announces that I am to address you on the subject of "Vehicle Advertising." For fear that I would not say just what I desired I have prepared a paper on this subject.

The object of this paper is to direct the attention of the carriage builders of the United States to an abuse that is working serious injury to them, both individually and collectively. The abuse is in vehicle advertising, which unfortunately in very many cases is a misrepresentation of the goods sold. I realize that this statement may find some criticism, and therefore, I want to make it clear to you that the misrepresentation that I refer to applies to the wheels of horse-drawn vehicles. My remarks refer to that part of the vehicle only.

"Printers' ink," using that term to mean all publications used for the advertising and sale of merchandise, is a great power—used truthfully, it is a power for good—but if used untruthfully, it is a great evil. This fact is recognized not only by all men in trade, but by law makers, both at home and abroad, who have endeavored to legislate for and against it until untruthful, exaggerated, or misleading advertisements have become unlawful.

The manufacture of buggies, carriages and wagons has been and is one of the most honorable lines of trade—and like most strong, honorable, honest men, it has stood for much abuse and misrepresentations, without giving much if any heed to either the condition or to the individuals that have defamed it.

Wheels for horse-drawn vehicles were originally made from the timber in young hickory trees of dense growth, which, for the want of a better name, was called "second growth." This young hickory was usually white in color—at least the larger portion of the tree was white, and it was soon believed that second growth all white hickory was the best material to use in the manufacture of vehicle wheels. The name "second growth all white hickory" was therefore the name that was used by the manufacturer of the wheels, the buyer, and the user of them, to designate best quality. This name and the meaning of it was known to the public generally, and every man who had to do either with the making or use of the wheel, from the tree to the vehicle, understood that the term "second growth all white" designated young, tough hickory of dense growth.

As time advanced, and as the demand for wheels increased, and buyers due to increased competition, became insistent for a lower price, the wheel manufacturers took that portion of the stock that came from these small trees that did not grade "all white second growth" and put it into a second grade of wheel, and called it "B" grade, changing the name of the first grade to "A"—and for a period of several years—First Grade or "A" grade—Second Grade or "B" grade—was the limit of grades.

But the demand was still for something cheaper, and both the maker of the wheels and the buyer of them endeavored to meet the demand. The cutting of exclusively young trees was abandoned—larger and older trees that produced more spokes and rims to the thousand feet of logs were cut and a third, or "C" grade was established—but the demand for cheap grade did not stop, and it was again supplied with a still lower grade of material, which was designated as "D" grade, or fourth quality. Certainly this was low enough—but no—competition became more keen and there must be something cheaper. A fifth or "E" grade was born. Then in the attempt to go still lower in price, a sixth grade, that is "E" grade with four piece rim, was made. Today there are six grade of wheels—A, B, C, D, E, and E with four-piece rim.

It is easy to understand that in making six grades the wheel manufacturers must use in the lower grades material that not so many years ago was thrown on the wood pile. This evolution of grades is not to be criticised—it was an honest effort upon the part of both the wheel and carriage manufacturer to

conserve every part of the hickory tree, and to meet a legitimate demand for cheap carriages and buggies.

One of the influences that induced the wheel manufacturer to make the low grade wheel was, that it enabled him to work up considerable stock formerly wasted, and the influence that induced the carriage manufacturer to buy it was, the price the wheel manufacturer could make on it for that reason.

The conditions, however, have reversed themselves—the surplus, in fact I might say refuse, in an ordinary wheel factory today is the high grade stock.

The manufacturer of calico is entitled to as much respect, if he sells his product as calico, as is the manufacturer of the finest silk—and the manufacturer of buggies who uses an "E" grade, four-piece rim wheel on his buggies and sells them as such, and by this process brings the cost of a buggy down to where it is within the reach of the man of small means, is entitled to just as much respect as the maker who uses an "A" grade—but the manufacturer of calico who would starch and polish his goods and sell them to the credulous for silk, would be entitled to very little consideration—or the maker of cheap buggies who would buy "E" grade, four-piece rim wheels, and advertise them in his catalog as "A" grade—and who would follow a prospective purchaser with a personal letter, very emphatically representing that "E" grade four-piece rim wheel as "A" grade—well, I think you will agree with me—is not entitled to much consideration.

However, the wheel manufacturers have made the wheels and sold them to the carriage manufacturers. The low grades have been made and sold way in excess of the timber run of the stock, and while it is true that the wheel manufacturers several years ago endeavored to call public attention to the various grades of wheels, it is also a fact that no earnest effort was made to correct the evil. Therefore, I feel that I express the sentiment of all wheel manufacturers when I say that the wheel manufacturers must bear equal censure with carriage manufacturers for the present unfortunate condition.

Untruthful and exaggerated misrepresentation of this kind has worked, and is working serious damage to the entire carriage business, and, as it is a mutual matter between us, it would seem to me to be a sufficient cause for some action looking towards a correction of it.

There was a time when all advertising mediums solicited the business of carriage and buggy manufacturers. Recently the maker of really a high grade line of work offered an advertisement to the Saturday Evening Post and it was rejected, and an investigation developed that the carriage industry, as a whole, was on the list with many other lines—they could not place their advertisement in mediums of this kind, because the journal would not be made a party to the misrepresentation that the carriage manufacturer published in his advertisements.

From the statistics compiled from actual shipments of 1,000,000 sets of wheels, less than one per cent. were of "A" grade—and less than 7 per cent. of both "A" and "B" grades combined. I firmly believe that if it were possible to show to the user the exact number of vehicles sold with cheap wheels represented as "A" grade, that there would be a revolution in the results, and that then there would be a very marked increase in the use of the higher grades.

It is quite evident that the manufacturer who uses an "E" grade wheel and who advertises it as "A" grade, has an advantage in his selling price over the one actually using "A" grade.

Is it not plain to you that this is one of the influences that is forcing the manufacturers of high grade work out of business, and driving their business into the hands of the manufacturers of cheaper work, being sold as "A" grade—and is it not clear to you that there should be some action taken by the carriage fraternity and the associate trades to correct such a serious evil?

There is already sufficient law to correct this evil if it was applied—untruthful, exaggerated, or misleading advertisements are unlawful.

In a recent suit brought by the owner of an automobile against an automobile manufacturer in Detroit, there was awarded to the owner of the automobile, \$8,000 damages for injuries caused by the failure of a so-called strictly second growth hickory wheel. It was clearly proven at the trial that the quality of the wheel furnished on the automobile was not such as was described by the manufacturer of the automobile in his catalog, and the judge in his charge to the jury in this case emphasized the fact that the statements made by the automobile manufacturers in their catalog, or prospectus, as to the quality of the wheel they were using, became their contract with the public, to supply such goods and that if they failed to do so, that they were liable in damages for any injury or loss caused by the failure of the wheel, because it was not of the quality represented.

The wheel manufacturers in the United States recognized several years ago the evil to which the trade was trending, and, as before stated, endeavored to call public attention to the

different qualities of wheels that were being made, by co-operating with the United States Forest Service, the spoke manufacturers, the rim manufacturers, and the National Hickory Association, by adopting standard grading rules for vehicle hickory woodstock. These grading rules were published in booklet form and scattered broadcast throughout the United States, and they are as complete a record as can be secured, of what the different grades of wheels should be, under the present system of grading—and they would combat any argument that might be offered by any buyer that he did not know what was contained in the different grades, as all wheel manufacturers sell goods made according to the standard grading rules.

Surely this is a subject worthy of the attention of the Carriage Builders' National Association, and if the officers of the association would appoint a committee to co-operate with the manufacturers of vehicle hickory woodstock, for the purpose of correcting so great a wrong, I believe that much good could be accomplished.

The sole object of this paper is the attempt to elevate the carriage industry to a higher standard and it is to be hoped that it may serve that purpose.

President Roninger: I think it would be a very nice thing to have an expression from our leading business men, manufacturers, both in the accessory and the vehicle line, as to their ideas as to the general condition of business, and the probabilities for the future in the next six months. I am going to call first on Mr. Champney, of the Eberhard Mfg. Co., of Cleveland, O.

Mr. Champney: My experience in this business has been that whenever we have good crops, we always have trade, barring a panic year or a war year. Just now the financial condition of the country is in such shape that very little business is being done. I believe this will right itself before many months. When it does we will all have our ordinary run of business. The season will be short and we will all be busy. I do not look upon the carriage business as a thing of the past; there will always be buggies. I want to say in regard to the harness business that there was more saddlery hardware sold last year than any previous year for six or seven years. The representative of a harness manufactory told me that they now have on their books taken before the war scare of August, larger orders than they ever had. This harness was to be delivered, starting in about October and following along in January to March first dating, as was their custom. There certainly was every indication of a very large trade in the harness line. We cannot use harness without some sort of a vehicle, but there will be trade in the vehicle line and trade will be fairly steady as I look at it.

Mr. Wrenn: We are in a cotton district. They cannot diversify the crops because the land will not produce anything but cotton, and the chief cities have come forward and helped in buying cotton at 10 cents per pound. We have seen a big improvement in the last few weeks. One member since I came here asked me to buy ten bales for him at 10 cents a pound. I look for a general improvement in the cotton situation soon. If we all get together and each buys a bale of cotton it will be appreciated more than anything else in the world. Unless something is done quickly we are going to get back to the conditions as they were after the war. I think in 30 or 60 days we will see an improvement in the situation.

Mr. Charles Adams: I would like first to congratulate you, Mr. President, on this particular innovation in our meetings here at the C. B. N. A. this year. We have men coming to this convention from all over the country. Every section has men working under different conditions in different branches of business, and I believe that it would be worth a trip to me to get the point of view of the men here in the carriage industry and in the accessory trades, and find out what they think about the business from their standpoint. Our situation in the carriage end of it is not any different from the rest of you; the same things that trouble you trouble us. The same things that make for business for you make for business for us. We have got still a good deal of faith. I remember that Mr. Champney, many years ago, instilled into me one thing that I have remem-

bered ever since, that is, it doesn't make very much difference at what stocks are quoted upon Wall Street, or what bonds are worth, but it made an awful pile of difference to us whether the farmer had crops; so we have always figured in our plans that if the farmers are successful, we would be successful, and we feel that rule still holds good, and we are still optimistic as to what the future is going to be. We have not lost our faith, and we believe we are going to have a good business this year, and feel there is going to be good value for everything. We believe the stuff in our line is as cheap as it will be in many years. In August when war was declared there were many men out of employment in Cleveland, but every firm is getting new business every day. Many men were thrown out of business immediately after war was declared, but now a number of concerns have received rush orders. One manufacturer of sugar machinery, which had almost closed down, received orders for sugar machinery, and today they are running night and day, working on sugar machinery. Another concern—an automobile concern (The White Company), were making automobile trucks and they were running very low, and they were cutting down their expenses and cutting down their men. Today the White people are running night and day with every man that they can employ in the manufacture of trucks for foreign trade. That thing has happened all over the country. I think we in America do not appreciate what we are going to get out of this war. We manufactured—the whole world—last year, 1913, 75 million tons of steel and iron of all kinds, of which 40 million tons were made in Germany, Belgium, France and England; 31 million tons in America, and 4 million tons in other parts of the world. The 40 million is out of business, and we should get a good portion of that business. I read in the paper yesterday of 22 thousand bales of cotton being exported. I am just wondering after all whether all of us will not find out that two-thirds of the trouble we expect will never happen. I wonder if we will not find when we get into the winter that we will be as busy as usual. I think we are going to have a lot of things we have not figured on. I talked with a gentleman yesterday from Canada. He went on to tell me that his concern had been very quiet all summer, but all of a sudden they began to get orders for the English government. He says that every concern in Canada that makes anything that is used abroad is going to have all they can do, and the overflow is going to come to America.

President Roninger: I am sure that we enjoy these talks. I think we have made a mistake in not getting together, and using just one day or one session to mix with each other and talk and get each other's views. It is unfortunate that the time is so short. We have to do this thing in such a great rush; but if I have anything to do with this association from this time on I assure you I shall endeavor to have meetings of this kind, and not have anything but little talks from our members. The accessory people and the carriage people should come here and take an interest in them. If we cannot get together and have meetings and do business as it ought to be done, we cannot have a convention. There is a great deal of work to be done and it always falls upon a half dozen men to do it. We want to talk to the traveling men, and get their influence and try to get them to join the association, for we are going to make it a better and bigger association than it has ever been before. This idea that Mr. Adams has brought up is going to help us. I want to ask for another five minute talk on the general carriage situation, and I am going to call on Mr. Dort.

Mr. Dort: I do not know that I can enlighten you very much on the general carriage situation. What the situation is for the future, of course, is conjectural. We can make the carriage business a success if we put our shoulders to it—if we get at it and push it as we have done it in the past. If we put the same vim and enthusiasm in it as we have in the past there is no doubt but what we can very greatly increase the business. There is no doubt but what we can hold the business of the country very much longer, that is, keep up the

general average very much longer than we naturally would if we do not give it the push we should.

We should realize the one other thing—those who are in the business—that even though it may be a contracting business in a way, we still can adjust ourselves to that condition in such a way that we can make the business a profitable one upon such an adjustment. We can go on in the vehicle business as we have been doing, making thirty, forty, five, ten or fifteen thousand jobs, and if our business is contracted to one-half or two-thirds of that amount, we cannot go on with the same overhead expense; we cannot go on with the same sort of an organization; we have got to get back to the old lines again; we have got to get down to brass tacks, to where we started in the game, and if we do get down where we started, if we get on the same basis where we started and put the same enthusiasm back of it as when we started it, there is no question but what we can make some money in the vehicle business. I do not know that we can go on and build up these enormous businesses that have been built up in the carriage industry, but we can do a profitable business; and those who are satisfied with a profitable business in the carriage trade can surely get it if they will get down on to that sort of basis.

I now want to say just one thing on little broader lines while I am on my feet. There has been some action taken in Congress, and there has been considerable discussion on the subject, that something should be done right now towards building up immediately a merchant marine in this country. It does not make any difference how that improvement comes about. We ought to step in right today, whatever the cost may be. It may make some men multi-millionaires; it may make some millionaires, but that is cheaper than to shoot down men; so I say this organization and every other organization ought to go on record, and this country should get at itself and at once build up, and purchase if necessary, but get by some means, boats to carry the products of this country, and the products of other countries to and fro upon the ocean. Now, we know that certain of the political parties have adopted this as a slogan; and we know that others have objected to it. It is something that should not be a party policy, to do things of that kind; but all parties, Republican, Democratic or Progressive, or whatever it may be, should join in an effort to immediately build up a merchant marine in this country, instead of standing back upon old party doctrines, perhaps. There never was a condition before similar to what exists now. We have never had an opportunity like this, and instead of standing back upon party doctrines they ought to come out for an American merchant marine. (Applause).

President Roninger: Take a speech like that; we have been going outside trying to get speakers. That is no reflection on the speakers that we get from the outside, but we have got them right in our association, and we are going to hear from them in the future.

Mr. Luth, chairman of the committee, made the following report:

Report of the Committee on Recommendations of Officers for the Ensuing Year

For members of Executive Committee to take place of those whose term expires: W. E. Maxwell, Indianapolis, Ind.; Chas. A. Lancaster, South Bend, Ind.; W. H. Roninger, St. Louis, Mo.; H. B. Staver, Chicago, Ill. (For term of three years).

For member of Board of Trustees of Technical School: Chas. J. Richter, New York.

For Secretary and Treasurer: Henry C. McLearn, Mt. Vernon, N. Y.

For Vice-president for each state represented in this association: First Vice-president, George Hackney, Wilson, N. C.; A. H. Ahlbrand, Seymour, Ind.; D. P. Hale, Anniston, Ala.; W. G. Norman, Griffin, Ga.; M. A. Steele, Freeport, Ill.; C. S. Walker, Des Moines, Ia.; Frank H. Delker, Henderson, Ky.; J. O. Schwartz, New Orleans, La.; H. K. Porter, Everett, Mass.; W. A. Paterson, Flint, Mich.; J. H. McCabe, St. Louis, Mo.;

John E. Hayford, Newton, N. H.; James H. Birch, Jr., Burlington, N. J.; T. J. Sullivan, Rochester, N. Y.; Geo. Gerstenlager, Wooster, O.; Robert Gray, Campbell, Ont.; James M. Yeakle, Bethlehem, Pa.; J. W. Anderson, Rockhill, S. C.; B. E. Parker, Suffolk, Va.; R. E. Wisner, Janesville, Wis.; H. Nicolaisen, Cheyenne, Wyo. THEODORE LUTH, Chairman.

In the absence of Mr. William H. McCurdy, of Evansville, Ind., Mr. Wilson read the following paper written by that gentleman:

PUBLICITY

W. H. McCurdy, Evansville, Ind.

Our esteemed president honored me by appointment to the chairmanship of the Publicity Committee, notice of which was received by me shortly after the meeting of the Executive Committee last November.

Since no specific duties were indicated in this appointment, it is presumable that the publicity committee was expected to initiate its own plan, and \$1,000 was voted for the execution of it.

Before giving the matter much thought, I accepted the appointment and then notified members of the committee that I desired to hold a meeting before January, but the replies from some of them stated that it would be inconvenient to attend. That subsequently nothing tangible was accomplished arose from the fact that we all were too busy filling orders early in the year, and too busy looking for orders later in the year, to attend to any committee business. I recommend, therefore, that in place of hearing a report, this convention devote itself to a very free interchange of views on the subject. To this end I will state that a plan of advertising vehicles in a general way under the name of the Carriage Builders' National Association was suggested to me, and was earnestly considered for a time, but the mediums through which such advertising should be made proved an insurmountable obstacle.

Stimulation of public interest could be expected only through use of the great journals of the country, and a campaign of that kind would consume money quite out of proportion to the benefit carriage builders would receive; nor could any possible way of raising the sum be determined, even though carriage manufacturers contributed to this publicity fund, five cents for each vehicle built by them, and though those vehicles amounted to half a million, the amount would still be only \$25,000, a sum quite inadequate to the purpose in hand.

Is it not, in fact, evident to us all that we should spend four times as much in advertising as we have in the past five years? That we neglected to do so betrays, to my mind, either a condition of strange indifference or a lack of confidence in our industry, which, if not promptly checked, will grow upon us to our great loss.

Advertising passed the stage of experiment many years ago, and now more than ever before do people watch the advertising columns of magazines and trade journals. Among the most successful men in this age must be included the large advertisers. A manager of one of our large cereal companies informed me that five years ago they spent \$50,000 a month in advertising. I inquired, "Why don't you skip a month now and then and swell your profit account by that much?" to which he answered, "We once tried that scheme and found our business decreased in proportion, so we concluded that our only way to maintain the volume of business was to maintain the advertising." Today this cereal company has nearly three times the business that it had then and a profit in the same ratio.

Again, suppose that our automobile industry, the rapid progress of which has staggered the world, had been as stingy with its advertising as the carriage builders have been, then it would have taken 50 years to accomplish what has been done in 12 years.

What encouragement have we given the implement dealers who handle buggies, and the straight buggy dealer, to order our buggies in carload lots? We haven't shown faith enough in his purchase of our vehicles to expend any money in advertising them, so what can we expect. I think that we are getting all that is due us; for I believe that \$7,500 would pay for all the advertising done in carriage journals by carriage manufacturers of the United States during the past year, whereas it should have been, in my judgment, five times that much. What shall we do? Sit and fold our hands and allow people entirely to discard the horse-drawn vehicle? Or shall we throw it upon the advertising screen under such a powerful light that they will know we are still in business? The latter, of course, and to that end let us convince the dealer by our lavish expenditure for advertising in the journals appearing each month upon his desk, that we have faith in our own goods.

I want to put myself on record today as stating that I think that the carriage manufacturers are standing in their own light,

that we should now take the carriage journals into our confidence and turn over a part of our profits to them in return for their active and zealous efforts to make a market for our goods. With our help they can convince the dealer that the buggy, the surrey and the spring wagon are still their friends and the articles on which they can make money.

The present conditions convince me that every manufacturer building a couple of hundred of vehicles a year should buy space liberally in the carriage journals, they being the best medium we have for reaching the dealer. A move of this kind will lead the dealer to conclude that the buggy business is again on the boom. The result will naturally follow that dealers will purchase more freely when our travelers call on them, and that finally having purchased stock, they will push sales with the farmer; moreover, the present time is most opportune for advertising buggies on two accounts; first, our neglect of advertising for the past few years has allowed many users of buggies to postpone purchases until tempting new styles and correct prices are offered to them; second, the depression owing to the European war will induce many purchasers to prefer the medium priced buggy to the expensive motor car.

The thought may come to some of our members, "Why doesn't the Hercules advertise according to the views expressed in this paper, whether others join in the campaign or not?" My answer to that is this: It will require a heroic and united effort on the part of all the carriage manufacturers to reawaken our people to the real usefulness and economy of the horse-drawn vehicle. We can convince the dealer, as he has made his money in handling them; he can and will convince the farmer, for it's money to him to do so. Dealers have told me that they no longer see buggies advertised and they naturally feel that the buggy is going out of use.

The Carriage Builders' National Association has an unnecessarily large surplus, and as the fundamental object of the association is to benefit its members, why not supplement the work of the members in advertising vehicles by a carefully thought out campaign on horse-drawn vehicles, in the name of the Carriage Builders' National Association, through journals having a circulation among the dealers in carriages. I would favor the buying of at least \$2,500 worth of space in this way during the next twelve months.

In conclusion I will state that I consider the necessity for showing the public that we are alive and doing well is so great that I will agree to the Hercules Company buying advertising space in the carriage journals, between October, 1914, and October, 1915, more liberally than ever before, provided that two or three of the other large carriage concerns and a reasonable number of the smaller ones join in a like agreement. I would even be willing to state a definite sum, provided others were agreeable to this, and I recommend that a committee consisting of three or five of our most prominent men be appointed to put in execution a plan so that all carriage men will agree to a strong advertising campaign.

Mr. H. A. White, of High Point, N. C., then read the following paper:

CREDIT BUREAUS

By H. A. White

I consider it quite an honor to be asked to address this body, and upon the request of Mr. Roninger I have chosen as my subject naturally the topic that is of most interest to me. I have been very much interested in the little talks we have had, and knowing that the south contains a problem that is of vital interest to us all wrapped up in the cotton situation, I have decided to tell you about a little organization that we have down there among the carriage men of the south, that we think has considerable future to it. You probably know that there are something like 40 or 45 carriage manufacturers in the southeastern states; their product is consumed there—about 100,000 vehicles annually. Out of these 40 manufacturers we have about three-quarters of the number in a little organization that we call the Vehicle League. The principal feature about this Vehicle League is the safeguarding of our credits, and this brings me to the topic that I have selected—"Credit Bureaus."

The co-operative spirit for safeguarding credits that has actuated business men in the past few years is remarkable and worthy the consideration of national association of business men generally. The old truth that "no man liveth to himself" has taken on a new meaning, as we see the springing up in nearly every town, city and business center associations of credit granters in response to this demand for the better safeguarding of credit risks. Small retail merchants occupying a very limited area of jobbers covering larger territory or manufacturers of certain lines of commodities consumed throughout the country, are becoming awake to the movement as never before.

The American desire for efficiency gave birth to the idea.

Too long have we been dependent upon what we may term second or third hand information in passing on credits. Our commercial agencies are good institutions and are considered standard in their line, and we cannot get along without them, but they have their limitations, which are very real and apparent. We are glad to have references from a prospective customer seeking credit, but it's against human nature to suppose he will refer to any house except those he knows will speak a good word for him. Many of us depend upon salesman reports, but who can size up a man by first appearances. We want facts in regard to his record, his business capacity and above all, his character. In fact, nothing but the acid test of actual experience covering years past will show whether the prospect is "Simon pure" or shot through with alloy.

To get at the actual experience of credit granters is the problem the Mutual Credit Bureau undertakes. I say mutual because that is the key note of the whole situation. When a community of men get together and mutually agree, that, for the safety of all and the general good of the whole, they will covenant and agree as man to man to report truthfully and accurately the actual trade experience on all their accounts that are asked for, there can be but one result, the good will be separated from the bad as distinctly as the proverbial "sheep from the goats."

The sensible thing to do then is for a credit grantor to conduct a credit bureau of his own or combine with his fellow merchants, jobbers or manufacturers as the case may be, and form a central office as a clearing house for the acquiring and dissemination of the desired information. A moment's reflection will convince you that the latter plan is the most feasible from standpoints of economy, ease of operation and efficiency, and in keeping with systematic twentieth century ways of doing things.

I am reliably informed that there are in the United States no less than 45 local credit bureaus in operation as one department alone of the National Association of Credit Men, an organization with over 18,000 members. From this we can begin to realize the enormous impetus of the movement. These half a hundred bureaus located in our principal cities operate as local institutions and each covers a small area, but they are beginning to take a step further in the logical development and arrange themselves in groups or zones with a central office for each trade center. In the west we hear of the north central zone, the south central zone and the gulf zone, and in due time I venture the prediction we will see the map of Uncle Samuel divided up into credit districts with limits well defined and full of possibility for conservation of credit values like the great reserve districts of our new currency system, which goes into operation tomorrow.

The operation of credit bureaus as applied to certain trades or lines of manufacture is not so well known in this country, but they are just as pregnant of good as strictly local organizations of a general nature. The most notable, perhaps, are wholesale and manufacturing clothiers, the wholesale confectioners, the publishers and stationers board of trade, and to come closer home, the vehicle accessories known as the Credit League, with headquarters at Cleveland, O. This feature in connection with the Vehicle League, the organization of southern carriage manufacturers, is the concrete example that I desire to tell you about.

It was in June, 1913, when a call went out to southern manufacturers and a few others who are interested in south eastern trade, to meet and discuss in a friendly manner ways and means for the "good of the order." Many abuses of the trade were named and suggestions made for eliminating them, and out of the maelstrom of conflicting opinion came this movement for exchange of credit information, that has proven so satisfactory and successful. Due credit is hereby given to our Cleveland friends of the Credit League for helping guide our feet in the right direction. They told us with what success their quiet little bureau was meeting and generously offered to open up their whole operations to our commissioner after we had gotten together on the proposition and picked our man for the job.

By September 1 of last year we had our association perfected, assessments levied, commissioner employed and all preliminaries made for launching the exchange.

Twelve months have now passed and the results have been far beyond our expectations. The membership has grown from 23 charter members to 34, and from the central office has been issued:

Over 400 signed financial statements;
1,600 signals;
4,000 clearance reports.

Covering a field embracing about 3,000 vehicle dealers.

Can you grasp the importance of this business census by which we can take an intelligent appraisal of our credit values? This storehouse of information with its ever accumulating wealth of knowledge we consider an asset of tremendous import.

We feel that we have now begun to use a standard of measure, as it were, of our credits, scientifically efficient. Every morning the first letter we open is the one from the commissioner with its signals, clearance reports, etc., conveying valuable information and often warning. If not of immediate interest these sheets are filed away for the future, making a ready reference catalog a guide to keep us from stumping our toes.

As to the duties of each member, they are very simple. Each item that comes up in our daily routine that has an unfavorable credit bearing, such as past due accounts, protested notes or checks, goods refused, excessive repair accounts, fraudulent claims, orders countermanded without cause and the many other sins of the trade, both of commission and omission, is signaled to the general office. The statement of mere fact is all that is necessary and each of us may read as he runs. Daily inquiry lists are also sent out and blanks furnished for tabulating ledger experience for one, two or three years back. The commissioner collects and systematizes all the information and sends it out to the members interested.

From the results of these operations the commercial pirates, deadbeats and sub-normals are gradually being eliminated, as the light of publicity is showing them up in their true relation, and on the other hand, the character and standing of the honest and capable are being strengthened.

The bureau is now starting on its second year of usefulness and with the entire confidence of our membership, who speak of its operations in relation to their business individually in the highest of terms. One says, "Saved us \$5,000 last year"; another "through the credit bureau we have been enabled to avoid some bad debts and put more confidence in reliable dealers"; another, "the moral effect of the league has enabled me to get better prices and shorter terms"; another, "consider credit bureau reports far superior to any we get from commercial agencies," etc., etc.

This brings me to the consideration of some of the by-products of such associations as those aside from the main issue:

1st. We find that the mere knowledge on the part of dealers that such an organization exists is beneficial and wholesome.

2d. The dealer who habitually practices unethical business principles is soon spotted and right here is found a means of relief from excessive repair accounts and questionable guarantee and other claims.

3d. A collecting agency operated on the side by the commissioner who has all this wealth of information at hand will undoubtedly prove of great success, but can be operated at little extra expense.

4th. Friendly adjustment proceedings may begin here in case a worthy dealer has met with unfortunate circumstances beyond his power to control, and is on the eve of bankruptcy with all its attendant waste of resources. The adjustment feature with us is as yet undeveloped, but right now we are face to face with unprecedented conditions in the south on account of the demoralization of the cotton market incident to the European war, and there will be ample room for co-operative adjustment this fall to ward off impending bankruptcy in many cases.

5th. And perhaps most important of all, this association has given us a common ground for co-operation, a bed rock as it were upon which we are able to build up mutual confidence and a feeling of comradeship in a common cause, tending to the steady improvement of trade conditions and putting a ban on our own practices that will not square with modern business ethics.

Gentlemen, when we reflect that there were last year \$300,000,000 involved in bankruptcy, of which amount it is estimated, by experts who ought to know, that 50 per cent. was absolutely useless, and 30 per cent. of the remainder, or \$45,000,000, could have been saved by timely adjustment proceedings, we begin to realize that this is a serious condition and not a theory that confronts us. "For lack of knowledge my people perish" as quoted from biblical lore, does not far miss the business situation of the present day. Give us more knowledge and that kind of clear perception of truth that the credit bureau movement is undertaking to discover.

You will all agree that American business mortality of today is soaring entirely too high. The assault upon the preventable bad debt losses that pile up on us year after year is a work worthy of our best method in this age of boasted efficiency. Would it be too presumptuous to suggest that your resolution committee present to this association at a future sitting for consideration, a resolution approving of the credit bureau idea, as applied to our various vehicle manufacturing centers, and to not only include the carriage trade but the wagon and wholesale saddlery trade as well, whose interests are identical with ours? To my mind there is no reason why a comprehensive plan of this sort cannot be evolved. It is quite in the range of possibility for this venerable Carriage Builders' National Association with its 42 years of glorious achievement behind

it, to foster this movement to such an extent that in the near future we will see half a dozen territorial credit bureaus that will cover the field from Maine to California and from the state of Washington to Florida, with one department of this association operating a grand central clearing house of credits.

The next order of business was the election of a president for the ensuing year. There being only one nomination, Mr. Charles O. Wrenn, of Norfolk, Va., was elected by acclamation.

Mr. Sayers, the chairman of the Cost Committee, read the following:

REPORT OF THE C. B. N. A. COST COMMITTEE

Your committee has worked out a cost system that they feel sure will be a great benefit to all members who will take advantage of it. Should we not get benefits out of this association, that are of value in a practical way, so that the members can and will look to their association as a help and a guide? We feel that this report is one of such benefits.

We recommend that this report be printed in pamphlet form, to be distributed among all the active members of this association and those associate members who may apply for it.

Mr. C. A. Eisenhardt, of the Sayers & Scovill Co., and Mr. L. A. Townsend, of the Durant-Dort Carriage Co., have assisted the committee, and have worked out the details of this report. Mr. Eisenhardt is here, and will submit the report, covering briefly its important details.

W. A. SAYERS, Chairman.

After the reading of the report by Mr. Sayers, Mr. Eisenhardt said:

We are presenting two reports, one designated as report No. 1 which is a full detailed cost system giving copies of all forms necessary to carry out the system with explanations of how to apply these forms to get the required information for cost records.

The other report is designated as report No. 2, and is a modification of report No. 1 giving the basic plan of correct cost accounting so that members may use it as a guide to get the information from their records as they may now be keeping them.

Mr. Eisenhardt read extracts from reports Nos. 1 and 2, which were quite voluminous. Referring to report No. 1 he said:

The main idea of this report is based on the desire to not alone reduce manufacturing costs, but to eliminate ruinous and unprofitable competition which is the result of guesswork costs and haphazard estimating.

The prevailing method of determining costs is upon an estimated basis, and no two carriage manufacturers follow the same plan in making their estimates.

This system is planned with the idea of requiring a minimum amount of clerical labor.

Because of local physical conditions, it will be necessary to modify many of these ideas to suit the particular needs of each organization, but in each case the underlying principles will be the same, and the results will be the same, that is to say, accurate, dependable, proven costs, based on a correct knowledge of the three elements of material, labor and expense.

At first thought these methods may seem to lead to a great deal of detail, but as a matter of fact they do not work out that way, and do insure that the work proceeds rightly.

The items of importance are:

- 1st. Perpetual inventory of stock so that in one case you will not run out of stock and stop production; and in the other case, so that you will not tie up too much money in surplus stock.
- 2d. Right care and issuing of material and parts to departments.
- 3d. Correct records of labor.
- 4th. Automatic check on piece-work count and day work time.
- 5th. Proper reports of spoiled and defective material.
- 6th. Correct records of factory expense.
- 7th. Accurate, complete cost of product.

Finally, the most important point to bear in mind is that it is not sufficient to have the form of system alone, but that

the system must be so carried out as to be effective, and not a mere form, and this requires proper installation at the start and proper training of those who are to use it to make it entirely effective.

The payroll of each factory should be so arranged as to show the productive and non-productive labor in each department, for in making up the expense analysis the data as far as labor is concerned will be taken from the payroll. It often happens that producers spend some time on nonproductive work, and the payroll should be so arranged as to show at each department, even where it is a productive department, both the productive and nonproductive labor in that department. (The speaker referred to form No. 5a and 5b).

In order that non-productive labor may be gathered accurately, we advise the use of a day work time card, shown in form No. 6, and the productive day work should also be shown on this card by operations, giving quantity of the parts finished, which will afford a satisfactory means of supplying the cost department with proper labor costs.

For keeping record of piece work performed, use coupon tags with a coupon for each operation, similar to form No. 7, adapted to work on operations in your factory.

In conclusion, it must be borne in mind that no cut and dried system can be laid down bodily in any plant and prove a success. At best the approved system can serve only as the basic plan from which to work, and hundred and one details must be carefully considered in each plant to guarantee the success of the whole.

The speaker then illustrated his remarks by referring to various forms he had prepared.

Referring to Report No. 2 the speaker said it was a slight modification of Report No. 1.

These reports were filed with the secretary.

The association then took a recess until the next morning, Thursday, October 1, at 10 o'clock.

THIRD DAY PROCEEDINGS, THURSDAY, OCTOBER 1, 10 A. M.

President Roninger called the convention to order. He stated the first thing on the program would be the report of the Committee on Statistics.

REPORT OF STATISTICAL COMMITTEE

In addition to the information compiled on wheels, poles and shafts, and axles, your committee has been able this year to secure reliable data as to the number of horse-drawn vehicles, buggies, spring wagons, carriages (all spring work) made between July, 1913, and July, 1914.

It is rather remarkable that the data secured from four distinctly different sources should be so uniform in showing the approximate product of vehicles, and that it does, speaks well for the correctness of the data furnished.

The committee desires to avail itself of this opportunity to express their thanks in a public way to the wheel manufacturers, shaft and pole manufacturers, axle manufacturers, and in particular to the several hundred vehicle manufacturers of the United States who have so cheerfully co-operated with the committee in this work.

Statement

Showing number of sets of wheels, number of shafts and poles, number of sets of axles, number of buggies, carriages, spring wagons (spring work) produced:

	Wheel Sets Production January to January	Poles and Shafts Jobs Production August to August	Axles Jobs Production September to September	Buggies, Carriages, Spring Wagons, Spring Wagon Production July to July
1905.....	1,216,224	1,310,000	1,345,268
1906.....	1,292,874	1,540,000	1,463,331
1907.....	1,202,559	1,340,000	1,517,634
1908.....	812,501	1,040,000	946,493
1909.....	1,115,925	1,062,500	1,185,286
1910.....	1,201,105	1,325,000	1,349,782
1911.....	1,097,308	1,075,000	1,344,820

1912.....	963,305	1,025,000	1,141,484
1913.....	988,200	1,127,500
January, 1914, to				
July, 1914....	493,590
July, 1913, to				
July, 1914....	868,000	1,092,832	786,392

It will be observed from the above statement that there was a less number of vehicles made from July, 1913, to July, 1914, than any previous year since 1908, and that there has been a slight decrease in the product each year since 1910.

The carriage manufacturers have so cheerfully and readily responded to the efforts of your committee to secure this information that the committee recommends that the work be continued with the carriage manufacturers each year in the future.

Expressions of trade conditions received by the committee from a large number of manufacturers show that up until the first of June this year there was every prospect of the year being one of the best that the carriage trade has enjoyed for some time. Some manufacturers report quite an increase in product—some quite a decrease. Since the first of June, however, trade has fallen off very rapidly, and a general pessimistic view seems to be entertained by most of the trade at this time, but in view of the fact that there was a demand for approximately 1,000,000 vehicles for the twelve months prior to the first of July, there is still cause for encouragement in the vehicle business.

O. B. BANNISTER, Chairman.

The Committee on Freight and Classification reported as follows:

REPORT OF FREIGHT AND CLASSIFICATION COMMITTEE

During the past year, your committee on freight and classification has closely followed all railroad matters affecting the vehicle industry, and we are pleased to report that we have been able to prevent such adverse changes as the railroad classification committees have from time to time docketed for consideration, so that at the present time the various classifications on our product remain practically unchanged.

The proposition before the southern classification committee to increase the minimum weight on crated vehicles from 8,000 lbs. to 10,000 lbs. for 36 ft. car, came up for consideration since our last report, and at the classification meeting held in Washington, D. C., we were directly represented and were able to convince the railroad representatives that such an increase could not be substantiated by figures covering such carload shipments in southern territory and the proposition was finally withdrawn from the docket.

On April 6, one of the members of our advisory committee appeared before the southern classification committee at their meeting in Chattanooga, Tenn., and succeeded in having a correction made in the southern classification on buggies, carriages and trotting wagons, so that we can now include extra poles and shafts, also bodies, seats, wheel and other vehicle extras, at the carload rate. This correction was necessary on account of the action of the carriers in charging less than carload rates on such extras, which resulted in several claims being filed, all of which we understand have been adjusted.

At this classification meeting we also petitioned the carriers for a first class rate l. c. l. on wagons and wagonettes when crated under 44 inches, but we were unable to secure such a concession at that time and the matter was deferred for later consideration.

The official classification committee docketed for consideration at their March-April meeting in Chicago, and later in New York, a radical proposition to eliminate Rule 10, which is of great value to shippers, as it permits the mixing of analogous articles at carload rate. A vigorous protest was made and through our efforts and the efforts of other shipping interests no change was made in the rule, and we can still continue to secure our materials in mixed carload lots, and pay freight charges on the entire shipment based on the commodity which takes the highest rating.

The question of an increase in rates in official classification territory, long under discussion, has been partially settled by the Interstate Commerce Commission granting the request of the carriers under restrictions which are not satisfactory to the railroads; and the proposition is again up for further consideration before the commission, with a view to the carriers securing further relief, claimed necessary by them. We believe the uncertainty as to the outcome of this proposition has had an injurious effect on the business of the country at large, and we hope, therefore, for a final settlement of the entire matter at an early date.

In the southwestern territory, the matter of readjustment of rates and minima still remains unsettled, although we have had several conferences with the railroad officials, particularly at meetings held with them in St. Louis and Chicago, but so

far we have been unable to secure adjustment to a single rate and scale of minimum.

This subject now has almost our undivided attention, and every effort is being put forth by this committee to secure the necessary adjustment, and we have every hope that in the near future we will secure what we have long worked for in this connection. We will then also endeavor to have the western classification amended so as to give us the benefit of a sliding scale of minima in keeping with the reasonable loading capacity of the different sized cars.

THEO. LUTH, Chairman.

ABUSES IN THE CARRIAGE AND ACCESSORY TRADES

In 1906 your association saw fit to abolish the general guarantee as unwise, still many vehicle manufacturers continued the stereotype guarantee in their catalogs.

Recently, your committee reached each wholesale vehicle manufacturer with a letter inquiring as to whether they had published a guarantee or warrant in their 1914 catalog, order blanks or price lists. Also asked if they would omit the guarantee in future catalogs.

A great number reported they had not printed a guarantee in 1914 catalog, and the majority reported they would not print it in future catalogs, and regretted our notice had not reached them earlier.

A few wholesale vehicle manufacturers claimed it was necessary for them to have a brief and concise guarantee on account of their selling the large jobbers.

Some interesting letters were received from the trade bearing upon the losses sustained, by the unfair dealer who sought to apply the guarantee as a full warrant to cover every part of a vehicle, or almost any kind of an accident.

Your committee have clearly in mind that fair and full value is always the keynote of success, but in our judgment it is unwise for manufacturers of medium grade vehicles to print a standard guarantee in their catalog, price list or order blanks. Very few catalogs for 1915 will waste space on the guarantee, and let us hope it will not be seen after the coming season.

For the year just closed we can safely report the abuses of the carriage industry as growing less.

If the unwise guarantee is withdrawn from carriage catalogs, the abuses and losses will be almost entirely eliminated from our industry.

Therefore, we hope some one will see fit to have a resolution placed before your convention: "Resolved, that it is unwise of the wholesale carriage manufacturers of the United States to publish a guarantee or warrant in their catalogs or printed matter.

PERRIN P. HUNTER, Chairman.

President Roninger: The next is the report of the Committee on New Members. Mr. William H. McCurdy, of Evansville, Ind., is chairman of the central division; Mr. C. O. Wrenn, Norfolk, Va., is chairman of the southern division; and Mr. L. E. Hickok, of Mechanicsburg, Pa., is chairman of the eastern division. I see only Mr. Hickok present. Mr. Hickok, have you any report to make?

Mr. Hickok: I cannot point to the result of my labors here. I assure you that I was strenuously engaged. I promised to get a list of 100 new members, and I am free to say that I got 95 per cent. of them. I had my eye upon one man, but he got away on account of the war.

REPORT OF PRESS COMMITTEE

This subject of publicity has never been given the systematic attention it ought to have. It has been the practice to put off all initiative until just before and during convention time. No plan has been carried out.

It seems to your committee that some kind of action should be taken in the future that could be developed into a plan that would keep up interest in the vehicle industry throughout the year, and to this end a plan is now being devised and perfected for submission to the next meeting of the executive committee, that we hope and believe may be followed, if approved, by very satisfactory publicity results.

G. A. TANNER, Chairman.

REPORT OF TRUSTEES OF THE TECHNICAL SCHOOL

In the absence of Mr. Daniel T. Wilson, chairman, Secretary McLear read the report as follows:

To the Board of Trustees of the Technical School:

Gentlemen—I herewith present my report of the Technical School for the year which closed yesterday.

The day and evening classes opened for the season on September 22, 1913, in the school rooms in the Mechanics' Institute at 20 West 44th street, New York City.

These two departments of the school closed on April 9, 1914, after the most successful year in the history of the school. The total enrollment in the day class was 15 students who came from the following named places: There were three from Connecticut, seven from New York City, one each from Missouri, Ohio, Michigan, one from Canada, one from Paris, France.

Nine of these men were body makers, two were superintendents, one was a general workman, one draftsman, one upholsterer, and one blacksmith.

The ages of these students ranged from 17 year to 32 years, and the average age was 23 $\frac{1}{4}$ years. The attendance of the day students averaged .9912 per cent. for the whole season.

The greater part of the members of the evening class were permanent residents of New York City, but quite a number came from different sections of the country and obtained employment in order to attend the school. The various trades connected with vehicle building were well represented, as follows: Body makers, 28; general work, 12; clerks, 7; general woodworkers, 5; draftsmen, 5; blacksmiths, 2; superintendents, 2; painters, 1; upholsterers, 1; total, 63.

A total of 63. This is the largest class ever attending since the school was opened in 1880. The ages of these men varied from 16 years to 34 years. The average attendance of the evening students for the season was almost 87 per cent. There were ten graduates, five from the day class and five from the evening class.

The names of the graduates follow: Joseph F. Gagnon, Otto F. Graebner, John M. Pullar, John A. Greer, Erwin L. Bare, James Forsberg, James D. Trehy, Howard P. Taylor, J. Henry Robinson, George S. Tasman.

The average age of these graduates is nearly 25 years.

The correspondence department of the school is kept open the whole year, and the following report is for the work done from September 1, 1913, to September 1, 1914:

New students enrolled.....	46
Lesson papers sent out.....	1,974
Examination papers sent out.....	270
Letters written to students.....	1,736
Rating cards sent to students.....	1,595
Number of drawings received from students..	1,336
Number of examination papers filled out by students	259
Number of letters received from students....	1,338

Our school is in a healthy and growing condition and is doing a larger work than ever before. During this year, help has been given to the school in Cincinnati and also to the one in St. Louis, both of which have been given lesson papers for the use of their students. About 100 lessons were sent to the Cincinnati school and nearly 3,000 to the school in St. Louis. Both these institutions are doing good work and both have as instructors, graduates of our own school.

ANDREW F. JOHNSON, Instructor-in-Chief.

President Roninger: I think that is one of the best things this association does—to keep up that Technical School. They have done great work. I wanted to say that the Wagon Makers' Club, of St. Louis, this past year conceived the idea of starting a technical school there, because there were so many young mechanics in every department of the vehicle industry that wanted to build themselves up. They wanted to learn the business, and the Wagon Makers' Club there started a technical school, and Mr. Johnson kindly sent about 3,000 copies of lessons. I think there are 50 lessons for each scholar to learn before he graduates. It has been a great thing for St. Louis, and it would be a great thing for any other city, because there are many young men who cannot go to New York to take up this branch of the business. Our schools there were surprised at the interest taken; they did not know that there was such an interest in technical education in the vehicle line, and when we brought the subject to their attention they kindly gave us a room, but that was not large enough. They had to have two teachers. This coming year they are going to give us a regular teacher there, and give us all the equipment for teaching young men technical drafting. The gentlemen who have charge of it are Mr. F. M. Roehlk and Mr. Herman Klix. Mr. Roehlk is a wagon maker and a fine draftsman. He gave his time gratis, in fact, the school committee there paid him his salary, but he would not accept it. He turned it back to the Wagon Makers' Club. He gave his whole time for nothing. Personally, I want to thank Mr. Johnson and the whole Technical School for what they have done for us in St. Louis and Cincinnati.

Secretary McLearn read an invitation from the Electric Vehicle Association of America to attend their convention at Philadelphia, on Monday, Tuesday and Wednesday, October 19, 20 and 21, at the Hotel Bellevue-Stratford.

ELECTION OF OFFICERS

The election of officers was next taken up. Secretary McLearn read the list of officers recommended by the committee on the previous day. On motion the secretary cast the ballot and they were declared elected.

Mr. Homer McDaniel, of Cleveland, was unanimously elected to represent the Associate Organizations as their western member on the executive committee.

REPORT OF THE COMMITTEE ON RESOLUTIONS

Mr. O. B. Bannister, chairman of the Committee on Resolutions, offered the following resolutions, which were recommended by the committee for adoption. He stated the first resolution was the one offered by the committee on costs, which was read by Mr. Bannister on Wednesday. He stated the committee recommended that before this cost system is printed, to have the cost committee go over both reports carefully and see that they are perfect before being put in the hands of the printer. He also reported the following resolutions for adoption:

Resolved, That the interchange of ledger experiences through credit bureaus as is in successful operation among southern carriage builders through the Vehicle League, receive the support of this C. B. N. A., and our members are encouraged to open similar bureaus in our various vehicle manufacturing centers.

Resolved, That the unprecedented condition existing in the south country—brought on by the fearful and disastrous European war, which has practically closed the avenues for the distribution of cotton, calls for the patriotic and substantial support of every American citizen.

Resolved, That it is the consensus of opinion of this association assembled in convention, that every member should buy at least one bale of cotton, and by this act contribute to the relief of the situation. O. B. BANNISTER, Chairman.

REPORT OF THE OBITUARY COMMITTEE

It is a pleasant thought expressed by the poet Longfellow in the Golden Legend, "The souls of them that die are but sunbeams lifted higher."

The song of the "Man of Wisdom" tenderly speaks of death as "the loosing of a silver cord; the breaking of a golden bowl, as a pitcher broken at the fountain; the wheel broken at the cistern; and man goeth to his long home, and the mourners go about the street."

Death of members of an association is always a solemn event, because of the ties of friendship and love then severed. The record of the past year is especially so because of the number and age of those who have passed into the Silent Land since our last meeting.

One was the honored chaplain of our association for the past 29 years; two died in the prime of life; four had passed the meridian, and four had even gone beyond the four score years, which is granted to but few. And, as we read the record of their names, it is with deep regret of their passing away, and loving remembrance of their past associations with us.

[The names given in the obituary list of Secretary McLearn were here read].

Therefore: Be it Resolved, that we join with the friends and relations in the sorrow of their bereavement, and that we extend to them our most earnest sympathy; and

Resolved, That as a token of our high regard and esteem, that this report be entered on our association record, testifying to our respect for each of them.

JAMES F. TAYLOR, Chairman.

The report was adopted unanimously by a rising vote.

Cleveland was selected as the meeting place for the 1915 convention and the convention adjourned sine die.

The Smith Wagon Brake Co., Houghton, Mich., capitalized at \$15,000, has been incorporated. The company is organized to manufacture a wagon brake invented by Charles Smith, and is financed entirely by Houghton capital.

TWENTY-FOURTH ANNUAL MEETING OF THE C. H. A. T.

The Carriage, Harness and Accessory Traveling Men's Association held its annual meeting Tuesday at 8 p. m., in the Marlborough-Blenheim, Atlantic City, N. J. In the absence of President Williams, Joseph Palmer called the meeting to order.

The presiding officer expressed his pleasure at the attendance and called for the report of the secretary, who reported 58 new members added to the roll during the past year; there were five deaths. The present membership consists of 286 active members, 42 associate and 5 honorary members.

The report of the treasurer showed a substantial sum.

W. W. Wood, chairman of the board of directors, submitted his report, given here in extract, which was duly accepted:

Your board of directors extends welcome to this, our twenty-fourth annual convention.

Looking over the year passed as an association we find cause for congratulation. From the first meeting in Springfield, Mass., we have felt that our association, if properly conducted



President G. A. Tanner, Publisher of The Hub

and fostered, was destined to develop into something far more important than a mere social gathering.

The twenty-second annual convention, which was held in Louisville with the Tri-state Dealers last year, was marked by a good attendance and a growth in membership of over 50, but, unfortunately, many of our active force were unable to be present.

The platform of our association may be summed up in the following from the constitution and by-laws: "Mutual encouragement, spirit and protection; securing members situations; informing the members through the secretary of all firms of doubtful credit; assisting each other in sales, where it does not conflict with the interests of the firms we represent; to obtain better railroad rates, and to aid each other in all honorable ways to promote the welfare and happiness of each other."

If this were strongly impressed upon every employer the traveling man could not fail to see that the association's objects have such a far reaching benefit that his and his representative's interests in it are mutual.

The cry "hard times," like the cry of fire, is alarming and panic provoking, and is as infectious as the measles. At this cry capital becomes as demoralized as the militia of Mexico and flees for safety behind steel doors and time locks, and thousands of commercial barks go down amid stormy seas of panic and distrust.

There has never been an era of universal prosperity in the history of the world. There has never been a time when the dwellers of any nation have had plenty of work and an abun-

dance of flour. Even in the days of general prosperity to the fellow that needs a dollar it is always "hard times."

In spite of all our trials, spite of our sins of commission and omission, the world moves on, and each succeeding question surrenders to its successor, wiser, broader, better, in spite of "hard times," and as brother salesmen we should band together for the mutual good of all, and our motto should ever be, "Never until the sun deserts you will I desert you."

The business world should mix confidence with energy, and each worker do his might toward hastening the era of restored prosperity.

There is hopeful feeling that the storm tossed waves of doubt and distrust may soon subside and the old bark of commerce once more sail on the seas of restored confidence and prosperity.

Let each hasten this end by ceasing to "croak" and striving to encourage prosperity. This country is too large and strong and intelligent to allow the army of commerce a long halt, and all are waiting the command, "forward, march!"

"There is no royal road to the prizes of life," as one eminent statesman has said, and we cannot be legislated into them. Bear in mind that kindly as many people are, generous as they may be in helping us and giving us encouragement, the only certain means of winning what we desire is the making of ourselves useful to those whose benefit and welfare our work affects. The opportunity for success is just as great today as it ever was, if one brings loyalty and confidence and intelligence and industry to the accomplishment of the task he has assumed. We cannot all be merchant princes or capitalists of industry, but every man can do well his daily task; can be loyal to the service he is in; be loyal to the C. H. A. T. and its allied interests, and with this thought we close, wishing you all a pleasant and profitable stay at this great pleasure city by the sea.

The report of the Obituary Committee was submitted by Grant Wright, chairman. Resolutions of sympathy were adopted, copies of which were ordered forwarded to the families of the deceased. The members who passed away during the past year were: Oscar Becker, James A. Haskell, Seth M. Chadbourne, George A. Small and L. M. Fitch.

After reading the report Mr. Wright suggested that some of the members might pay tributes to the memory of the departed brothers, and Fred Gowen in a talk full of delightful memories, paid glowing tribute to the men.

W. W. Wood, in beautiful words and verse, brought the memory of the departed close to all, while P. D. Randall and H. E. Copeland made appropriate remarks.

Nomination for officers resulted in the election of G. A. Tanner, publisher of *The Hub* and *Harness*, of New York City, as president for the ensuing year.

Jesse L. Nelson was elected secretary-treasurer to succeed himself, and complimented for his work of the past.

The following vice-presidents were elected: F. J. Johnson, Los Angeles, Cal.; W. H. Diggs, Forth Worth, Tex.; Charles A. Quigley, Salt Lake City, Utah; Max Robinson, Martinsburg, W. Va.; M. S. Bottume, New Haven, Conn.; J. Frank Hutcheson, Covington, Ky.; F. S. Collins, Amesbury, Mass.; W. P. Lippincott, Merchantville, N. J.; G. O. Ballentine, Cleveland, O.; R. A. Bittong, Philadelphia, Pa.; C. G. Ranno, Manchester, N. H.; J. M. Palmer, Brooklyn, N. Y.; A. M. Williamson, Denver, Col.; W. F. Terry, Baltimore, Md.; H. I. Nelson, Woodford, Maine; A. P. Cleaveland, Detroit, Mich.; J. C. F. Jackson, St. Louis, Mo.; O. S. Hass, Mt. Vernon, Ind.

The Board of Directors for the year are: W. W. Wood, chairman, Philadelphia, Pa.; E. A. McGrew, New York City; F. D. Reed, Boston, Mass.; Grant Wright, Philadelphia, Pa.; P. D. Randall, Springfield, Mass.; F. H. Gowen, Little Falls, N. Y.; H. E. Copeland, West Newton, Mass.; George W. Huston, Cincinnati, O.; J. F. Galvin, New York City; E. B. Williams, New York City; G. D. Lousberry, Troy, N. Y.

Several members spoke about the past and future of the C. H. A. T., and the meeting adjourned at 10:30 p. m.

THE BANQUET

About 100 were seated at the tables of the "shore dinner" given in the Marlborough-Blenheim on Wednesday evening. The guest table was graced by the presence of men conspicuous in the C. B. N. A., as also leaders in C. H. A. T.

President-elect Tanner presided, and Grant Wright did the honors as toast-master in his usual happy vein. Many ladies were guests of the members.

Menu

Blue Point Oysters on the Half Shell	
Celery	
Clam Chowder, Shore Style	
Radishes	Olives
	Gherkins
Crab Meat Deviled in Shell	
Cucumbers	
Planked Sea Bass	
Potatoes, Duchesse	Stuffed Green Peppers
Romaine Salad, French Dressing	
Coffee	

BANQUET SPEECH OF W. H. BERRY

We have elsewhere commented on the speeches of the banquet incidentally. They were all of high average. We cannot give space, owing to limitations, but we think the address of Hon. William H. Berry of such serious business character that its essence, which we have tried to preserve and present, is important reading for business men. The speech, in part, here follows:

I do not know whether in your business of carriage makers you are troubled with this monopolistic idea—with this idea of the arbitrary arrangement of the channels of business. Most of the activities of our time are thus troubled, and I for one am under the impression that at the bottom most all of our economic troubles come out of the fact that more or less, or in one form or another, we are suffering from the results of monopoly.

A monopoly—and I shall be very brief—is simply anything, anywhere that interferes with the free flow of natural activity into any channel where a scarcity exists, and the opportunity is more favorable for the product. There are some of them natural and some of them artificial. The artificial ones are the ones with which we have to deal. They confine their basis of operations in three general lines. We have them first beginning in the original instance, perhaps, in the land, natural opportunity. Sooner or later the world must wake up to the fact that this world with all that it contains, the land, the air, the water and all the natural resources are the common heritage of God's people—not only of this country but of every country and of all countries, and we must come to address ourselves to some method whereby the monopolization of natural opportunity shall be eliminated. I do not wish to occupy any of your time along that line.

The second great channel through which this insidious influence operates is transportation. It is perfectly clear to any mind that specialized industry, which alone must measure, as a matter of fact, the progress of civilization. Robinson Crusoe alone upon his island must do everything for himself. He is jack of all trades and master of none. He never knows how to do anything well. He is troubled with a low existence. New men coming on to the island they commence to specialize. To get distribution these men must get together. Some people have an idea that you cannot make a profit without robbing somebody. That is a mistake. Profit is the great incentive to human industry rightly understood. It is the most delightful and beautiful thing we have, out of which comes all our works of art and all our permanent wealth. Profit and profit alone makes these things possible, and anything, no matter what it is, that interferes in the slightest degree with the free exchange of products between all men is deleterious to the progress of civilization. That is the point I want to make and the one point. We cannot prosper by the peculiar prosperity of a few, but from the elevation of the masses everywhere all over the world is to come the final solution of all our economic troubles. Therefore, anything anywhere which interferes with the free access of any individual to the warehouses of goods, accumulated wealth, is harmful. Now, we have a good many evil things among us, but if we could get the right kind of people to handle these monopolies then they are a good thing, because you can find some things that are a benefit in these large aggregations of capital.

Now it came to pass when there came to be a number of producers in a community that money came to be one of the equivalents in their exchange.

The debts of the United States, a conservative estimate puts them at eighty billions of dollars, which debts are secured either directly or indirectly by some permanent form of wealth.

Let me ask you to make a distinction between the permanent and transient form of wealth. You do not give a mortgage on a load of watermelons; you do not give a mortgage on perishable things. If you want to float a debt you place a mortgage upon something tangible or permanent, like your warehouses, hotels, hospitals, etc. These are permanent forms. May I ask you to distinguish clearly between those individual forms of wealth? There is a limit to the amount of perishable forms we can use. If we all went to work to raise watermelons, for instance, or any other kind of food products, we would raise more than we could consume, and it would be wasted. There is absolutely no limit to the amount of these permanent forms which we may own and enjoy.

Now because of their permanency they become the basis of debts. If by any process the price or the money involved begins to go out of the house or the factory or railroads there is trouble. The house cost \$5,000, and has a \$4,000 mortgage upon it. If I could sell it for \$5,000 the mortgage can be paid and I can have my equity. If it goes down to \$4,000 the mortgage takes it all and I am down and out. So you can see the consequences that must inevitably follow to the owner of a piece of permanent property which is the basis of any form of debts. When that situation supervenes the holders of this form of wealth cannot endure. Now they are declaring moratoriums all over the world. What is it that causes or that determines the price of these forms? The law of supply and demand. That alone, absolutely.

When wheat is abundant and oats are scarce you will get more wheat for a bushel of oats than when oats are abundant and wheat is scarce. Inevitably, under all circumstances, everywhere, just so the amount of money that you will get for a given amount of permanent property is determined absolutely, first by the amount of money that is offered in the market for those things as compared to the number of things that are offered in the market for money, and that and that alone determines the general price level. Then when you see the price go down and disaster threatening, what is the alternative? You must either make money more plentiful or houses less abundant. You have refused to allow the people of the world the absolute opportunity to produce money ad libitum. As a consequence, when this obligation matures there is one alternative left, stop building houses; shut down the game; put idle the bricklayers and the plumbers and the decorators and all kinds of workmen throughout the world. Anything which prevents the free flow of trade in any channel where scarcity exists is a monopoly. That is a monopoly, not natural; absolutely not artificial in the sense of its creation, but purely a legal enactment done by the consensus of opinion.

A banking business is run just like an insurance business—on the law of averages. I go to the bank to get a note discounted, say for \$100; it is the experience of bankers that on the average nine out of ten checks that are written will be carried to the bank and be credited to the party who presents the check. It is also a fact that the tenth man will want the money, and he has to have it. If the man asks for the money from the bank, the bank has to give it to him at once; so it comes to pass in order that that bank can discount a note for \$100 it must have 10 actual dollars in its possession. Now it may have all kinds of property; it may be worth a billion; it may have blocks of houses, but if it does not have a ten dollar bill it cannot discount a note for \$100. That is the banking business. That has been the theory of banking in the United States for the last 40 years. Moreover, the situation is like this: That bank has \$100 in actual money, surplus, reserve; it can, therefore, discount a note for \$1,000. That is the bank side of it. On the outside of the bank counter stand three men who want to borrow \$1,000. Neither of them have assets to put up as security. Only one of them can possibly be accommodated. This is the situation in this country and has been for the last 15 years. Let us follow that through. Here is Mr. Smith and Mr. Jones and Mr. Brown. Mr. Smith is in the ice business and the president of the bank has some of his stock in his inside pocket. Mr. Brown is in the glass business and Mr. Jones is in the ice business also and is a competitor of Smith. They all go into the bank to borrow that \$1,000, which is all the bank can loan. Smith says he will give 4 per cent. for the money, Brown says he will give 5 and Jones says he will give 6, three men bidding for the one loan. That puts the interest rate up to the highest possible level. The banker says to Smith, "What do you think about 6 per cent.?" and Smith says, "I will give you 6 all right." Which of those three men get it? Does Jones, the competitor of Smith, whose stock the bank owns, did he get it? No. Did Brown get it, the glass maker? No. Smith got it, and he would get it if you were a banker or I was. Then you have everything that is involved in the money trust or financial trust there illustrated.

One-half of the business of the known world is done in the United States every day in the year. Two-thirds of all the

banking business on earth is done in the United States today and has been for years. We have been regarding this thing of ours as one of the side shows. Yes, gentlemen, we are the whole show as a matter of fact any old time we get ready to assert ourselves. Never before have we been in a position where the world by its own folly has put itself into the position where it will be compelled to accept the proposition involved in this new currency law of ours. If there is anything that we can be glad about in regard to this war, it is that it has forced these men of Europe; they will be compelled to look to the United States as their financial saver.

WILLIAM BRUCE TEMPLETON

A former owner of *The Hub*, and an estimable man from every angle, passed from this life on October 11, at his home in the Borough of Brooklyn, and W. B. Templeton will live as a cherished memory among a wide circle.

Mr. Templeton was born of Scotch parents in London, October 17, 1844. He was educated in the thorough manner common to British lads of the better middle class. At 16 he began his business life in a London office in the East Indian trade.

His leanings seem to have been strong for the country that



finally claimed him as a naturalized citizen, and in January, 1874, he became acquainted with New York, the city that became his home.

One of his first ventures was with Valentine and Company, and it was here he became aware of the scope and field of *The Hub*, as the journal was founded by that famous varnish house.

About 1877, through affiliation with John R. Walker, a merchant in the varnish gum business, also an agent for the Harland varnish, he undertook to sell this English product to the carriage trade, and incidentally became the first foreign varnish advertiser in *The Hub*. It was Mr. Lawson Valentine's policy not to admit American-made varnish to the hospitality of its pages, but English products were not forbidden to enter.

After a few years Mr. Walker relinquished Harland's agency, and undertook Mander's, so Mr. Templeton still continued as a salesman of English varnish until 1880.

He had done some work in the subscription field in the interest of *The Hub*, but he soon became identified with Clarence Brooks & Co., where he remained for a year, but road work being distasteful, he became, in 1882, business manager of the Oil, Paint and Drug Reporter. As long as Mr. Allison, or the interests identified with that gentleman's personality were dominant, Mr. Templeton remained, but in 1883 he became an associate of Hildreth and Jennings in the varnish making busi-

ness. In 1886, after Hildreth, Templeton & Co., had been incorporated as Hildreth Varnish Co., Mr. Templeton returned to the publishing business, that always had the strongest attraction, as manager of the Oil, Paint and Drug Reporter.

In 1890 he again changed front, becoming the first secretary of the Oil, Paint and Varnish Club, an organization largely due to the initiative of Mr. Templeton.

In 1891, *The Hub* was relinquished by Valentine and Company, and he was soon installed as vice-president, and later purchased the controlling interest of the Trade News Publishing Company, which was then, as now, the owner of *The Hub*. In 1898 he sold his holdings to Taylor and Gregory, which holdings were finally taken over by the present owners.

It may be fairly said that indirectly and directly Mr. Templeton had been in touch with *The Hub* for years, and his loss seems very personal and intimate to those now identified with the publication.

The last 15 years or so, Mr. Templeton had been in the dry colors business with G. A. & E. Meyer, as office manager, so that to the end of his busy and useful life he had been identified always with varnish, colors, or publications having to do with such businesses.

MOVING AN ARMY BY MOTOR

Twelve thousand motor cars have been placed at the disposal of the War Office by the Royal Automobile Club, yet it principally represents but a tenth of the total number of cars that could be obtained from motorists in Great Britain, says Light Car and Cyclecar.

If each car could transport five soldiers and kit we should have an army of 60,000 men, mobilizing at speeds 10 or 20 times as rapid as is possible with the more ordinary methods.

Five men to a car would be a fair average, and, given 20-30 h.p. cars, there is no reason why these should give any trouble with this load; but in the event of sudden mobilization, if necessary, the authorities might attempt to crowd as many as ten men on to the same sized car.

What a scene it would be—12,000 cars roaring along some great highway! Tremendous excitement, columns of dust rolling up in clouds between the telegraph wires, every cross road guarded by the villagers.

Let us see if we can calculate the speed at which the mobilization of an army by motor car can be accomplished over, say, a distance of 100 miles. Assuming the men to be moved and the motor cars to carry them to be grouped together into sections, then, once the drafting of the men into the cars had been done, it should be possible for at least 300 cars an hour to pass along the road. This means to say that the rate of mobilization would be 1,500 men an hour.

The distance to be covered would not be of such great importance, and, in any case, they could not be expected to take more than a day, even were the call so far distant as from London to Liverpool.

With open roads and guarded crossings, an average of at least 30 miles an hour could be maintained, which means that, within 3½ hours of starting, roughly 100 miles could be covered.

Speed is everything nowadays. To be successful you must get there first, and, with the obvious lesson of the present mobilization before people, it is to be hoped that more attention still will be given to the improvement of the roads.

Yes; it is wonderful, this dream of great masses of men being transported by motor swiftly, and silently, and, let us hope, surely; but it would require a most perfect organization and a knowledge of the country and local conditions second to none; but we may see some such venture attempted, even as the first 1,500 Germans were stated to have entered Belgium in motor cars with instructions to spread havoc far and wide.

A car body built of the new febromonolithe that is seen on a recent French automobile, does not contain a single seam.

PAINTING FOR NOVICES

It is the custom to pass up the simple beginnings of operations, because all that is taken for granted as something known and forgotten long ago. But there are newer and younger hands considering the painters' art almost weekly, and even the old hands under whom they work are prone to take a lot of knowledge and practice for granted. We think the Australian Coach-builder is on the right track in going over these lessons in the primary class, and some of the instructions we pass along for whom it may concern.

Puttying Up, Stopping, etc.—This is branch of the trade in which some become proficient in a very short time, while others take years to arrive at the same standard.

For a start, two knives are necessary. For ordinary work, a knife with the blade about four inches long, with a good spring, will fit the case; but if you are doing panel work that requires stopping all over, as is frequently the case with repair work, the best knife for this operation is the short, square-ended knife with the blade about two inches wide. These two knives, along with a palette on which to carry the stopping, will be all you require. By using a palette to carry the stopping you are enabled to use it much thinner than when holding it in the hand. Besides, the habit of holding stopping in the hand is open to grave objections. Firstly, the stopping becomes dry through contact with the warm hand; and, secondly, you are contracting a very dirty habit that is unhealthy and likely to set up a case of lead poisoning later on.

Hard Stopping—This is made with dry white lead mixed in gold size, with just a dash of hard varnish. Take the dry lead out on the stone. Crush it up to a fine powder and mix to a soft paste. Beat this with a piece of wood (an old spoke will answer). While beating gradually add a little dry powder to the mass until you have the whole about the consistency of dough. This will give you a good reliable article for stopping up all imperfections on body panels, seats, etc.

Mixed as above and tinted as you would lead color, you are now ready to start operations. Go carefully over the work and putty or stop up all holes and dents. Press the stopping well into the holes, working the stopping in opposite directions. In the case of very large holes, such as screw holes, a second stopping is necessary; in which case in the first stopping you almost fill the hole, then run the point of the knife lightly across the stopping in the form of the letter X; then, laying the edge of the knife on the panel, draw it sharply across the hole. This will clear off any stopping that may be on the panel. The idea of crossing the stopping with the point of knife is to give the second stopping a better hold. The reason for drawing the knife edgewise across the hole is to remove stopping that if left on to harden would require labor to remove.

In the course of four or five hours apply a second stopping to all places that require doing. In repair work it is sometimes necessary to stop up a panel all over, in which case it is advisable to make the stopping a little thinner with gold size. For this operation take the square-bladed knife already mentioned. With this tool spread a coat of stopping over the whole surface. Level down as nicely as possible as you go along, doing a strip about the width of the blade. You may work from top to bottom or end to end. The former, as a rule, will be found the most convenient of the two.

The following day take either prepared stone or pumice, the former for preference, and face down stopping to a level surface. If the stone clogs during the operation a rub on an old flat file will remedy the trouble. This gumming up during facing down is very often caused by having the lead coat of too oily a nature. Using a little ground pumice will more often than not check this evil. If not, try a little common soap. Try and do without this if possible; but if resource must be had to soap do not leave it on the panel for any length of time. The action

of soap on fresh paint is likely to cause trouble unexpectedly later on.

After all facing down is finished, allow the work to stand an hour, which will allow sufficient time for all moisture to evaporate. The work may then be sandpapered down with 1½ paper. If the body was in bad order, requiring a large amount of stopping, it is advisable at this stage to apply a coat of lead. If there are only a few patches showing stopping, apply a coat of lead to those places only, and when that has stood for half an hour to allow the stopping to absorb a portion of the oil color wipe dry with rags. By doing this you add a little elasticity to the stopping, and it will also allow you to apply the succeeding coats more evenly.

Most color manufacturers now put up a paste filler, and they answer well where the whole surface is broken and fissured. Such surfaces require levelling up, and the paste fillers are excellent for such purposes. They are easily applied and rub to a smooth face. They are superior to the shop made article.

Resurfacing Running Parts—We will now take the running parts in hand, describing the various processes that are adopted to rebuild a surface. First, we have stopping made with dry white lead mixed in equal parts gold size and turps. Thoroughly mix this on the stone; next transfer to the palette; with the putty knife stop up wherever necessary, omitting all joints which must be filled with putty, this stopping being too brittle to withstand the vibrations of the vehicle when in use. If it were mixed tougher too much time would be lost when sandpapering down. Do not use stopping round the spokes at the hub, or round the tire. Reserve those places for putty. When this stopping is finished, mix up putty as follows: Take best gilders' whiting and mix to the consistency of dough with raw oil and just a pinch of gold size. Beat it thoroughly and putty up all joints on job. Allow to stand until next day, when the work may be well sandpapered.

When puttying round the tire do not try to fill the joint up level; rather try to show it by pressing the point of the knife in the joint. Show a uniform bead right round the rim, leaving no lumps or sharp edges on the face of the rim. Another method is to take the paste filler in place of the above. You may have a new job showing the grain badly, or an old job in a perished state. The best plan to follow here is to thin up such places by rubbing the stopper in with a piece of cloth. With new work you can fill in all open grain and leave hardly any on the surface; but in the case of old work that is in a bad condition one is compelled to leave a certain amount on the face of the work, which must be removed by sandpapering.

Although this process of building up surfaces with the aid of dry white lead produces a fairly level surface, it is dirty, disagreeable work; and what is more important, it is unhealthy. When sanding down you cannot help inhaling the dust that arises, which, being composed of lead, is highly injurious to health, especially to a young lad. In a factory where this system is in use he must make the best of it; but, if possible, it is strongly recommended to all to pass this use of lead out altogether. Not only the one who is sanding down, but everyone working in the vicinity, is compelled to inhale a certain amount of this poison. Pass it out, and in its place use Japan putty.

Japan Putty—This is made with best gilders' whiting. Break the whiting up to a fine powder and mix with two-thirds raw oil and one-third good black Japan. Mix and beat well to the consistency of ordinary putty. With this putty you have an article that will work easy, dry in a reasonable time, and will hold in position with any other putty that is made from any other formula.

When using this putty take a little more time in dressing up; or, to put it another way, the time you usually spend sandpapering and stopping device to Japan putty, as the latter hardly requires sanding. As black Japan is liable to tarnish, for white or yellow grounds use whiting, raw oil two-thirds, gold size one-third.

HISTORY AND DEVELOPMENT OF THE ANVIL

While everyone is familiar with the anvil of today, in its high state of development and graceful lines, it is doubtful if very many, even blacksmiths of the present age, would recognize the rough, crude, uncouth lumps of metal of primeval and medieval times as the common ancestor of our present-day anvil.

The history of the anvil takes us back to antiquity, where its origin is lost. That it was used at a very early date is manifest, for, even before the discovery of man, pre-historic man used an anvil of stone upon which he chipped and shaped his spear and arrow heads of flint.

The writer had the pleasure of seeing one of these pre-historic anvils which was discovered many years ago in the north of Scotland while some excavations were being made. The anvil, a large, irregular block of yellow flint one side of which had been chipped and worn to a comparatively level surface, was found amidst a heap of flint chips, arrow and spear heads, some of which were neatly chipped and finished, while others seemed to be only blocked out.

To follow the history of the anvil it is necessary to go back to the time when copper and bronze were the metals in common use. Having ample proof that the ancients were familiar not only with the art of casting copper and bronze but of forging them into tools and weapons, which they hardened, it is therefore safe to assume that the first metal anvils were of copper or bronze, probably alloyed with other metals and hardened. Research has failed to bring to light any anvils of copper or bronze, but there seems to be little doubt about their having been used.

No definite date can be assigned to the first knowledge of iron, but the earliest hieroglyphics to which an accurate date can be fixed, the pyramid texts of the fourth millennium B. C., prove beyond question that iron was well known in Egypt and was forged into instruments, weapons and tools. It would seem, however, that for a period of about 3,000 years its existence remained more or less in obscurity, as it is not until the time of Homer, 880 B. C., that noticeable attention was given to iron. At that time it must have been considered of less value than bronze, from the fact that objects dug up from the mounds of Nineveh, of about the time of Homer, many were composed of cores of iron around which bronze had been cast.

Dr. Percy, in referring to the finds from the mound of Nimrud, says the Assyrians were well acquainted with iron, as is clearly established by the exploration of Lyrad, who has enriched the collections of the British Museum with many objects of iron of the highest interest from Nineveh. Among these worthy of particular attention may be mentioned tools for the most ordinary purposes—as picks, hammers, knives and saws, which could be of a date not possibly later than 880 B. C. The fact of iron having been applied to such ordinary tools as hammer heads, for which bronze might have been a fairly good substitute, would clearly indicate that by that time, for tools at least, iron had superseded bronze.

A few centuries later, Thucydides describes a chain of iron made use of by the Plataeans, during the siege of their city by the Thebans, 429 B. C., which was used to suspend beams which were dropped so as to break off the heads of battering rams brought up against their city.

Quoting Pliny the elder, in recounting the treaty which Porsena granted to the Roman people on the expulsion of the kings, 509 B. C., there was a specific provision that iron was not to be used except in the pursuits of agriculture, and the most ancient authorities have preserved the fact that it was at that time that writing with a bone style came into practice.

Besides the literary evidence of iron having been used at an early date by the Romans, we are not without actual samples. At the Saalburg near Homburg, Germany, which was built and inhabited as a Roman fortress between 11 B. C. and 274 A. D., there is still preserved the iron chain and its hook which were

used to raise water from a well. It is claimed that the chain is welded and beautifully made.

The use of iron and the anvil being synonymous is the only reason for the writer having gone so far into the early history of iron and having said so little of the early history of anvils. Actual specimens of the very earliest anvils are so rare that their size and shape is more or less a matter of conjecture.

Julius Caesar mentions that when he invaded Britain, 55 B. C., the currency of the people consisted partly of iron rings adjusted to a certain weight. Thus at the beginning of the christian era we find that both the Romans and the Britons had long understood the working of iron.

Up to and for several hundreds of years after the beginning of the christian era nearly all objects of iron, including chains, were of square or rectangular section. This may be accounted for by the fact that iron is easier to draw down from a lump by hammering on an anvil into flats, squares and rectangular sections than to any other shape. It would also indicate that in early blacksmithing, few if any tools were used other than anvil and hammer, and that the anvil itself had not been developed beyond the type at present used by saw makers, i. e., a rectangular block without the overhanging tail or horn. The tails and horns of the earliest anvils were of the most rudimentary character, often barely extending over the base. There is no question about the art of smithing and the anvil having developed simultaneously.

From the 12th to the 17th century, smithing all over Europe reached a stage bordering upon perfection, but no attempt was made to standardize the shape of the anvil. The reason for this would seem to be that as a rule every smith was his own anvil maker, and an anvil being a piece of equipment that lasts a lifetime or over, it stands to reason that there were few if any expert anvil makers in the middle ages.

Anvil making as an industry was first started at the Mousehole Forge, Sheffield, England. How long ago there is no authentic record, but for well over 200 years anvils have been made for the trade at the Mousehole Forge, which for two centuries, at least, was the only works of its kind in the world. The first of whom there is a record of having operated the Mousehole Forge in anvil making is the family of Sir John Burgoyne. Then Cockshutt & Armitage, and following them came M. and H. Armitage who operated the forge for over 100 years. The present owners, Brooks & Cooper, have run the works for upwards of 38 years, and are still making anvils that are hard to beat either in quality, shape or workmanship. Although there are now a number of concerns making anvils, both in England and America, the Mousehole Forge is unique in several respects. They were the first to specialize in anvil making, they were the first to make any attempt at standardizing the shape of the anvil and they operate their forge to this day with no other power than that developed by an old-fashioned water wheel.

For well over a century there has been practically no change made at the Mousehole Forge. The same old-fashioned helve hammer, or "metal helve," as it is locally termed, is still doing duty and is operated by the already mentioned water wheel. The building itself, with its old-fashioned solid stone walls and low arched windows and doorways, shows but slight signs of the ravages usually worked by time, and are apparently good, barring misfortune, for centuries to come.

Originally Mousehole anvils were made by the building-up process, that is, the corners of the base or feet, the horn and the tail or heel were welded on to a centerpiece. After this the steel face was welded on in sections. The anvil was then trimmed and finished to the desired shape by the use of hand tools. The face was then ground and hardened and, after hardening, the face was again ground and the anvil then received the finishing touches.—J. Cran, in American Blacksmith.

Motor omnibuses are to run between Bagdad and Beirut, Syria, a distance of over 500 miles.

CYCLECAR DESCRIBED BY A PARTISAN

Mr. W. B. Stout is the engineer of the Scripps-Booth Company, a concern that seems to be sticking. For this reason what he has to say ought to have the weight of authority based upon a foundation of success. He tells many interesting facts not generally known about production, especially relating to the cost of parts.

The cyclecar movement started with the desire of producing the cheapest possible motor vehicle. This desire still obtains throughout the industry, but it has been learned by cyclecar makers in their experience to date that what were first considered the cheapest construction were not developed to a point which made them advisable as was thought for the construction which was at first attempted.

The first makers of European cyclecars placed the weight at from 450 to 500 pounds and spoke of the extreme simplicity of the V motor, belt drive, together with tandem seating. This publicity started America along the line of similar development, for it was well known that the motors and transmissions named were plenty capable of handling the 450 to 550 pound vehicle on the narrow tread.

On building up the cars it was found that the advertising weight of 450 pounds came nearer to 750 in actual fact, while some of the cars ran up as high as 900 pounds, even on 36-inch tread. In spite of this fact the motors handled the work well, made high speed and covered long distances. The chief objection of the motor from the standpoint of the public was noise, and from the standpoint of the manufacturer, sales, while the manufacturers of cars objected very strongly to the prices which were demanded for these V motors. In theory the V motor is much simpler than the automobile motor, having fewer parts and somewhat less weight. On this theory it would be possible for makers of V motors to build these for less money than a four-cylinder motor of greater horsepower and more reliability, of less noise and of more flexibility for less money, even including radiator and with connections, than he can buy the usual first class V twin.

The first cars using friction and belt drive have found that they can buy a complete gearset and clutch of standard construction for less money than other belt drives, while the sales cost with this standard construction is much less than this newer drive, to which the public must be educated.

From the standpoint of the cyclecar enthusiast who has talked V motors and belt drives one feels that something has been lost in that the makers have in so large number left the seeming simplicity for more complication and trouble from the standard arrangement than has been enjoyed in the V-motor and belt-drive construction.

It would seem from this that the cyclecar idea is being lost sight of, as so many predicted at the beginning of the movement, and that the smaller car movement only was being solved. This, however, is far from being the case.

No Maker Has Yet Seriously Entered the Field

There is still the field of the ultra-light cyclecar, a field which as yet no manufacturer has seriously entered. This field is the one which is to produce the simplest possible car, and it may be with the V motor of new and simpler construction than has been offered, and with some simpler form of transmission than has been built to date, or it is possible that the car may be light enough and the motor powerful enough, so that the clutch and chain to the rear axle may suffice for all ordinary running of this car, which will sell for not over \$300. It is probable that this vehicle will be built to seat one person like a motorcycle, but with an extra folding seat which can be used for overload trips.

The other class of car is going to a larger sized motor, so that most of the light cars have motors around 95 cubic inches; the weights come up to 1,100 pounds and few below 900 pounds, treads 36 inch to standard, while all sorts of seating arrangements are being used.

Road Quality Never Equaled

As to cars which tried out tandem seating and narrow tread, nearly all of them are retaining this idea. A road quality has been discovered in this type of car which so far has never been equaled in any other type of road vehicle. There is a handiness about the narrow car in city traffic which cannot well be imagined when one realizes that these cars slip through narrow places as with a motorcycle, that they accelerate faster than big cars and stop as quickly.

The cyclecar on the road does not run between the ruts, as has been claimed; as a regular thing it runs for the most of the time with one wheel in the rut and the other wheel on some good, smooth surface which may be outside of the left-hand rut or the right-hand rut, or in the middle of the road, or even off to one side on a path smoother than the ruts themselves.

One of the angles of cyclecar development which must not be forgotten in designing the car is that of sales. The public is mechanically educated; they know construction—they know how big cars are made, they know what big car construction will do and ignore the limitations of these constructions which have become common and which they are used to. A cyclecar owner will stand twice the trouble from a four-cylinder engine of standard construction than he will from an experimental or unusual type of motor, and this must be taken into account in cyclecar work. The man who can best understand the advantages of the cyclecar is that man who is now driving a high-priced heavy car. He knows its limitations; he knows that money alone does not produce comfort and maximum speed. He wants to get to his business and back in the shortest possible time with the least possible effort and dirt. He knows his present big car holds him up in city work, and narrow-tread cyclecars are showing him also that he is being held up in country work. As a result he is ready to buy a cyclecar when he can be shown one that has all the dignity of a big car, has all of its lines and finish, has real equipment and is luxurious in its equipment. The future will see cyclecars of aristocratic construction as well as the spidery four-wheeled motorcycle at \$300. It is very probable that within the next two or three years cyclecars will be produced, costing as high as \$1,000, which will sell in quantities on performance alone. As yet it is impossible to define the cyclecar, but the writer is of the opinion that the cyclecar will be sold as a vehicle of maximum road performance under all conditions for two or three-passenger service.

RECEIVER FOR AMERICAN VOITURETTE

The Detroit Trust Co. has been appointed receiver for the American Voiturette Co., builder of the Car-Nation. H. L. Stanton states that all creditors are being notified by letter of the situation. The application for the receivership was made by a creditor.

The receiver states that the liabilities according to the company's statement approximate \$231,000. No statements of assets is made, but there is material for 600 Car-Nations on hand in construction and material for 100 Keetons. The receiver will carry on manufacture of these parts as soon as the inventory is taken.

REORGANIZES STANDARD ROLLER BEARING COMPANY

S. S. Eveland, former president of the Standard Roller Bearing Co., which went into the hands of receivers last year, has plans under way for a reorganization of the company.

It is understood that the plan of reorganization contemplates the payment to the company of a large sum for working capital, and also the payment to creditors of a certain percentage of their claims, including debenture holders, banks and mercantile creditors, the balance to be paid gradually. All stockholders will retain an interest in the concern.

FOREIGN TRADE—VERY BEST WAY TO GET IT

We think an important help is being afforded manufacturers who want to export by the National Association of Manufacturers. We copy here at length some of the features of its Foreign Department, and its services, as they give a clear idea of the assistance rendered, and how it is supplied.

For carrying on its work the Foreign Department maintains a permanent office staff of over 30 people, a still larger affiliated staff of specialists and experts in various lines in New York and over 1,500 correspondents in foreign countries.

The Foreign Department comprises the following bureaus: Bureau of Information, Bureau of Foreign Buyers, Credits Bureau, Collection Bureau, Translation Bureau, Bureau of Patents and Trade Marks, Bureau of Publicity, International Freight Bureau.

Following is an enumeration of the services which are open to members through the Foreign Department and the regulations concerning them:

Market Reports—Information regarding trade possibilities in foreign markets free of charge. Special investigations and special reports undertaken on terms to be agreed upon.

Lists of Buyers—The addresses of a limited number of selected business houses in any foreign country in one year, free of charge. Additional lists and rated lists on terms mentioned in Appendix No. 1.

Foreign Agents—Addresses of firms or individuals in any part of the world in a position to represent manufacturers.

Credit Reports—Ordinary reports on the commercial standing of five business houses in any foreign country in one year, free of charge.

Collection of Debts—Collection of debts against debtors in any foreign country, without responsibility on the part of the Collection Bureau or the association.

Collections of Drafts—Through the association there may be secured at lowest rates collection of drafts on foreign customers and prompt remittance of funds.

Translations—Translation of 25 business letters from or into any language in one year free of charge. Translation of additional letters, printed matter, catalogs, specifications, legal documents, etc., on stated terms.

Forwarding of Goods—Shipments of merchandise from factory or shop to warehouse of customers in any foreign country effected through the International Freight Bureau, which also looks after all details connected with foreign forwarding, such as preparation of consular invoices, marine insurance, etc.

Export Campaigns—Advice and information pertaining to the intelligent starting or development of export campaigns, the details of which are of such variety that they cannot be enumerated in brief space, but which the valuable records and personal experiences of the staff enable the Foreign Department readily to give or secure with least loss of time.

Customs Duties—Information from official sources with respect to the customs tariffs of any or all countries on terms to be agreed upon.

Special Trade Opportunities—Important contracts and opportunities for business are brought to the attention of members by special letter.

Confidential Bulletin—Information through the Confidential Bulletin twice a month regarding foreign trade opportunities and inquiries for American goods, free of charge.

American Trade Index—Distribution periodically of American Trade Index, which contains descriptions of members' products, readily intelligible to English, Spanish, French and German speaking people, to firms throughout the world most likely to be interested in American goods.

Reports on Schemes—Reports on advertising and other schemes and propositions, at home and abroad, with respect to export trade, free of charge.

Patents and Trade Marks—Information regarding patent and

trade mark regulations in any country, free of charge. Patents secured and trade marks registered in any country.

Financing of Exports—Advice and assistance in the financing of exports of manufactured goods and import of raw materials.

Foreign Exchange—Information regarding the money and exchange of all countries.

Raw Material Supplies—Information with respect to the sources of original supply of any class of raw material.

Promotion of Business—Foreign inquirers furnished with names and addresses of American manufacturers of articles desired.

Employment Division—Through this division manufacturers can be supplied with expert assistants in any branch of export work.

The N. A. M. undertakes to supply any member, in one year, free of charge, with the addresses of a limited number (not to exceed 50) of selected importers, dealers or agents, in foreign countries or, in lieu thereof, a directory list of firms in one line of business in the leading cities of three countries, or of three lines in the principal cities of one country.

Trade Marks

In some countries an unauthorized person may register an existing trade mark and such registration may prevent the rightful owner from afterwards using it. Therefore, one of the first matters which a manufacturer seeking export trade should consider is the legal protection of his trade mark or trade name abroad.

The Patents and Trade Marks Bureau affords information and the best advice on the subject, and undertakes the registration of trade marks in any country.

THE O.K. CUTTER

H. K. Porter, Everett, Mass., is making a 10 in. and 14 in. two handed cutting tool similar to the "Easy" and "New Easy" bolt clippers so long and favorably known to the hardware trade in all parts of the world.

The name cutter has been adopted to differentiate the new line from the old ones, and prevent confusion in ordering. The new line also will not be known by the old size designations, No. 0, 1, 2, 3, 4, but will in all sizes be named by the length of the tools; thus the two sizes now ready are Size No. 10 (for 3/16 in. bolts in the thread) and Size No. 14 (for 1/4 in.

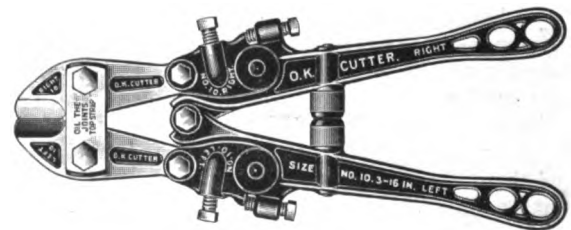

bolts in the thread). These tools are now made with two kinds of edges to the jaws, one the bolt clipper edge, or cut, in which the jaws have a large bevel on the top side and a small bevel on the bottom side of the jaw for trimming bolts, rivets, and other work required to have nearly a flat end. The other style of edge is called the center cut, in which the two bevels are equal, and the edge is in the center of the thickness of the jaw.

These tools have a new adjustment—the simplest yet designed—and the cutter head, being attached to the handles by connecting bolts, can be changed from one style to the other at a moment's notice. Jaws with several other forms of cutting edges for other purposes will be made for these tools in the near future.

A little kerosene, poured into a box before running in the babbitt, will prevent the explosion that sometimes occurs.

CYCLECARS, IN THE FOREIGN VIEW, LIGHT AND CHEAP CARS BASED ON RADICAL REVISION OF ENGINEERING DATA

While standardization is more and more becoming the leading idea for the production of automobiles on a large scale, the cyclecar movement tends in the opposite direction, furnishing an outlet for the constructive energy which during the past half dozen years or more has found itself at variance with accepted ideas. Cyclecar builders are in fact staking their investments on the belief that the great experience which the world has gained in building motors which will run and continue running, and in making parts which will stand the strains of motoring, should render it possible now to undertake a constructional housecleaning, as it might be called, and thereafter produce a much better or much cheaper transportation machine of any class by starting afresh—with the experience gained but otherwise an unbiased mind with regard to general design and mechanical details—than those which have come down through the years burdened with superfluities and half-errors. As the matter is viewed, makeshift details of small merit were copied year after year from models which were in the main successful in the market, and some of these details became standardized and were never viewed afterwards, either singly or in their relation to the complete vehicle, in the light of all that meanwhile had become known and understood about motor vehicle construction. In nearly all cases, according to the average builder of cyclecars, a construction feature handed down from a previous year and not found particularly objectionable, or one noticed in a leading car and susceptible of imitation, received the benefit of the doubt in the comparison with any proposition to abolish or remodel this feature, provided such a proposition was based merely on reasoning, and the majority of manufacturers were too busy making hay while the sun shone, or thought they were, to launch into costly experiments at any point of construction that did not urgently demand a revision of previous work.

It is particularly believed among the new radicalists that the general understanding which has been gained of essentials in motor vehicle construction should easily make it possible to chop down the cost of production by picking out the traditional features which can now be recognized as unessential and eliminating them judiciously, in whole or in part, getting the consent of the public by virtue of the lowered sales price. When the cyclecar is also conceived as a very small car, it is not because the size has anything to do with the general view of motor vehicle engineering problems of which the cyclecar is the upshot, but because small size and small price go well together and because a minimum price is a commercial necessity if the conservative public shall be made to accept anything that bears the earmarks of a radically new deal. The word "cyclecar" is a fortunate find well adapted to facilitate this acceptance by making the new constructions appear to be a new class of vehicle, the purchase of which might confer the distinction of sporty progressiveness, and the attempted definitions of the term "cyclecar" serve the same purpose, but in the logic of events the cyclecar is simply an embodiment of the idea that it ought to be well worth the while of some energetic young engineers to clean out all the useless and cumbersome rubbish which has been accumulated in the constructional household of the automobile industry during 20 years of ceaseless acquisition and expansion, and to do this housecleaning work with an eye single to lowest cost of production, since it has been so conclusively shown that the largest market for automobiles—and the only one susceptible of unlimited expansion in the future—lies with the masses, who will not pay as much for an automobile as for a house.

Will Cyclecars Come to One Type?

The great variety of cyclecars already in the field fail, as might be expected, to show any unanimity with regard to ways

and means to be employed in the process of simplification, and it is therefore commonly prophesied among engineers of the conservative group, as reported in *The Automobile*, who believe above all in standardization and letting well enough alone, that faults will crop out in all the types produced and that the gradual correction of these faults will eventually bring all the little black sheep of the family, excepting those whom the bankruptcy wolf devours, back to the fold where construction work is done on the plan of safe evolution. To undertake new construction and cheap production at the same time comes anyway, they assert, under the head of "optimistic engineering," which is akin to invention, and, as everybody knows, the practical success of inventors is not measured by their enthusiasm; they are all ardent for their ideas but only something less than 1 per cent. of their number are found able to overthrow status quo and add a mite of their own to the data of engineering practice. Against all of which the cyclecar engineer very positively and confidently asserts that all the big progress so far recorded in automobile building is due to inventors, among whom only less than one dozen were also full-fledged engineers, while to the credit of the school engineer and his conservatism stand mainly the refinements, which come of themselves where time and money are at disposal, and those very superfluities which the cyclecar designer has made it his purpose to remove for the benefit of an expectant public.

Viewing the situation somewhat along the lines indicated in the foregoing, the French and the German automobile press, with the uncompromising logic characteristic of these nations and lacking a word equal to "cyclecar," refuse to take the cyclecar as in any sense a separate development from other light little cars, and even the British have their eyes open for the abundant chances for blundering which it offers when conceived in ignorance of the early experiences of the automobile industry and therefore with disregard of the real "data" which present automobile construction represents, but it is nevertheless becoming recognized in all the European countries that the housecleaning idea is a good one and that the time has come to probe very searchingly the traditions of design and mechanics on which the automobile industry has been living. Nothing could serve this need better than the cyclecar movement.

Among the propositions for simplification which have come up both in England and France that of abolishing the motor hood is one of the most far reaching, as it involves changes in the appearance of the motor and a wider adoption of the plan of placing the radiator, if any is used, behind the motor and in close union with the dashboard. It also escapes the criticism to which many cyclecar simplifications are subject; namely, that they have a tendency to produce a tinny car. The omission of the hood works in the opposite direction, while the changes which it is necessary to make in the motor arrangements in order to have the innovation acceptable to the eye make for a business-like and characteristic appearance which cyclecar makers should welcome.

WHITE LEAD MANUFACTURE IN AUSTRALIA

A Sydney, N. S. W., concern manufacturing white lead from concentrates is issuing \$150,000 new stock for erecting an enlarged plant. The company was originally started with \$50,000 capital. It obtained patents in leading countries and proved the value of its output, the estimated profit on which is about \$50 per ton. This lead is said to be in high repute for painting. The process, it is stated, produces sublimed white lead direct from the crushed ore almost instantaneously, the product being conspicuous for its fineness, evenness, and absence of crystals. It is claimed that it goes much farther than ordinary white lead and lasts longer.

The rank in number and value of motor cars produced in various lands is as follows: United States, Great Britain, France, Germany, Italy, Belgium, Austria.

A BENEDICT NOW—CONGRATULATIONS

The "at home" cards of Mr. George W. Huston, president of The Spokesman Co., have been issued. The home of the bride and groom will be Cincinnati.

We show the "counterfeit presentment" of the groom as he appeared about three years ago, when he was in the ray of The Hub's limelight as president-elect of the C. H. A. T., on which occasion we were glad of the opportunity to press all



the journalistic honors and identification the circumstances called for. This is a practice of The Hub which we notice, much to our friendly amusement, more honored in the breach than the observance by our energetic Cincinnati contemporary.

As other well wishers are doubtless doing, we express our felicitations.

PHILADELPHIA VEHICLE DRAFTING COURSES

The fall term of the Class for Vehicle Draftsmen and Mechanics, in the Central Branch Y. M. C. A., 1421 Arch street, Philadelphia, opened Wednesday evening, September 30. The class will be limited to 50 students. The class will be conducted in two sections, one for the advanced, the other for new students. It is open to all vehicle mechanics of Philadelphia and vicinity.

The teachers are Thomas O. D. Grier, who has had practical experience as journeyman and foreman in carriage and automobile factories for the past 30 years; C. Erich Schutte, who will teach the principles of drawing, studied mechanical drawing in Europe.

The course in vehicle drafting, prepared by Chas. A. Heegeist, technical editor of the Carriage Monthly, will be on Tuesday and Thursday evenings, from 7:45 to 9:45, and the program is as follows:

The course is divided into five parts. Parts A and B are taken by all students entering the classes. After these are completed the student has the option of taking up Courses C, D or E. Course F is special.

Course A—Preliminary instruction bearing upon the geometry of vehicle designing and building. Curves and ovals; simple side elevations; front and back elevations and bottom views of straight and curved surfaces; methods of laying out these views on the draft.

Course B—Practical Problems in Vehicle Drafting. Geometrical problems relating to carriage, automobile, wagon and motor truck building. How to obtain the different bevels, inclinations, contractions and lengthenings. The dihedral angle. Making patterns for inclined and contracted pieces. How to cut the end surfaces and lay out on the draft the thicknesses and shapes of all the pieces of the body frame work.

Course C—Drafting of bodies for horse-drawn carriages. Light and heavy carriages, their dimensions, as width, length and height; straight and curved surfaces; laying out the working draft for straight, squared, contracted and inclined parts. The combination of parts, known in practice as "framing."

Course D—Horse wagons and motor truck bodies; plain and fancy. Designing attractive bodies. Various styles of commercial bodies and methods of framing and paneling the different kinds. Dimensions, lengths, width and heights. The suspension of light, medium and heavy wagon bodies and trucks, including one, two, three and four-horse gears.

Course E—Automobile Body Drafting. Light and heavy pleasure car bodies; dimensions and proportions in relation to the chassis; widths and lengths relative to the comfort of the passengers. How to lay out the parts on the working draft and how to frame all the parts on the body. Obtaining the curves for seats and bodies. The construction of movable tops, including hinges.

Course F—The suspension of carriages and wagons; division of weights; position of wheels; turning wheels under body; various styles of vehicle parts; proportions and dimensions of parts.

CELEBRATES ITS FIFTIETH ANNIVERSARY

The Illinois Iron and Bolt Co., at Carpentersville, Ill., observed the 50th anniversary of its organization on September 17. The celebration was held in Carpenter Park. The business of the town was suspended for the day; stores were closed, factories were shut down, the public and parochial schools were closed, as were the banks and barber shops, while the post-office was open only at the arrival and departure of mail trains. Everybody joined the procession leading to the park, and during the afternoon every street in the town was almost completely deserted. Nearly 4,000 were present.

After the big picnic dinner, in which nearly every family in the Bolt company employ took part, John Fierke, president of the concern, gave a short address of welcome. Dr. E. F. Cleveland, vice-president, addressed the assemblage, giving historical facts and reminiscences. Base ball and other games filled in the remainder of the day.

TOLEDO COMPANY CHANGES OFFICERS

The Milburn Wagon Co., which will place a light electric car on the market in the near future, has announced a change in officers. Frank Hafer, formerly treasurer of the company, has resigned to accept a position with another firm. F. H. Dodge, who recently resigned as president of the Ohio Electric Car Co., becomes treasurer of the Milburn Co., and has also been elected a director in the company.

Otto Marx, formerly of the Ohio Electric Car Co., has been elected vice-president of the Milburn Co., taking the title of H. R. Kelsey, formerly vice-president, but who was never active in the management of the company. Mr. Kelsey remains a director in the company. Roger Woodhull, also formerly with the Ohio Electric Car Co., has been appointed sales manager of the electric automobile division of the Milburn Co.

The Automatic Wagon Brake Co. has been organized and incorporated at Lawrenceville, Ill., with a capital stock of \$10,000, to manufacture improved vehicle brakes. The incorporators are O. E. Gillett, W. S. Titus and A. F. Hill.

FORGE-FIRE MAKING

The first and most essential object in forge fires is coal, which should be of the best quality. First of all, the forge should be thoroughly cleaned of all ashes and cinders, and don't forget to clean the underside as well, as one cannot get a clear blast if ashes are left in the bottom of the box and the blast forced up through them. Cinders are then bound to be driven up into the firebox. A good way to start the fire is to take a stick about four inches thick, that tapers down to about two inches, and place the small end over the hole in bottom of firepot and pack all around with wet coal, after which stick can be removed. Be sure to get fire started clear to the bottom and have plenty of good coke to feed with. Keep sides well packed and run fire level, and no difficulty will be experienced in getting a good heat. Many smiths do not give enough attention to their fires. I have known men who would poke the ashes away with their hand to make a little opening, put in their kindling, get a blaze started and then expect to do good work. This is a great mistake, as good work with a poor fire is impossible. Another man will continually run the poker into the fire and lift it up. To my mind this is bad practice—keep fire close and well packed is my way of doing.

There is only one thing to do when a fire becomes poor, and that is to clean it out and build a new one. I saw an illustration of this a few days ago, where the smith had been working his fire all morning, heating only when a job came along that required a weld. At the end of the day he did not want to bother with the fire, so he put some coal on and started a job. It looked well in the fire, but as soon as the air struck it it turned a pale yellow and would not stick. The man tried a number of times without results, until finally he threw it down in disgust and said he believed he had forgotten how to weld. Later on, the helper made a new fire, and the smith started again, this time having two welds to make, as the piece had wasted away with the many heats. With the new, clean fire he had no trouble whatever.—H. N. Pope.

ST. LOUIS VEHICLE ASSOCIATION MEETS AGAIN

The regular monthly meetings of the Implement, Vehicle and Hardware Association of St. Louis were resumed on Monday evening, September 14, the session being held at the American Annex. Dinner was served and the meeting held in the large banquet hall on the roof of the hotel. In view of the fact that the ladies had been invited to the dinner the entertainment committee secured as one of the speakers Mrs. Walter McNabb Miller, Columbia, Mo., president of the Equal Suffrage League of Missouri, who made an address. John L. Messmore, ex-president of the Merchants' Exchange, also delivered an impromptu talk.

RULE OF THUMB VS. TECHNICAL

To illustrate the point on a theoretical ideal car, in 1905 Duesenberg, educated in the common schools of Iowa without so-called technical education, obtained in schools and colleges, followed out a design he had used in producing a motorcycle. By common consent that motor proved to be the greatest two-cylinder motor ever put into an automobile.

Duesenberg built a single-cylinder motor so arranged that he could produce any degree on his camshaft by threading his shift and by an ingenious device could raise or lower the cylinder and thus increase or decrease the compression and could also set the cylinder off center on one side, then by careful experiment under a brake test he determined the proper degree to set his cams, the proper compression and the proper offset.

SHOP-MADE GRINDER

The engraving shows a grinder that I made for rough grinding. I forged and turned everything except the stones and the pulley, and it is still giving good service.

The foundation and frame are one piece, as indicated, of concrete. The foundation is set down in the ground about two feet, and the center line of the shaft is four feet above the ground. The bearings (B) are made of strap iron, and bab-

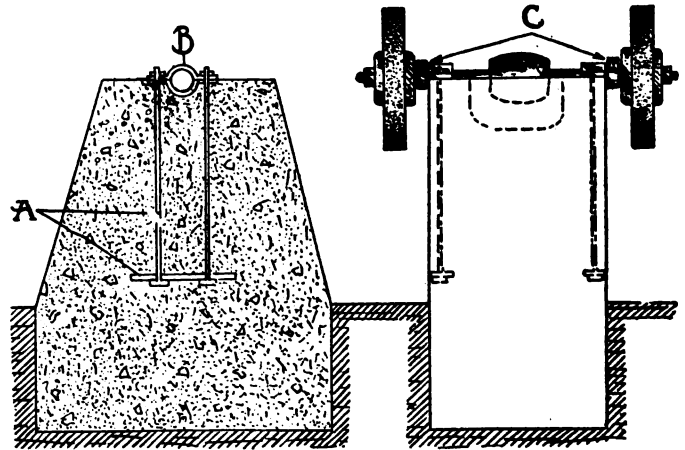

bitted. They are held firmly in the concrete by the anchor bolts and plates (A). In the center of the concrete frame is a depression, to allow for the pulley and belt. I used the collars (C) on this machine, but I would advise omitting them and turning a shoulder on the shaft instead, as I experienced a little trouble at first in being unable to make the collars rigid. The inside collars holding the stones are, of course, held by the collars (C), while the outside collars are held by the nuts on the spindle.

This grinder is inexpensive and easily made. The only difficulty in making it is to get the bearings in alignment.—N. G. Near, in American Blacksmith.

PHILADELPHIA CARRIAGE AND WAGON BUILDERS

The regular monthly meeting of the Carriage and Wagon Builders' Association of Philadelphia, was held on Friday evening, September 18, at the Hotel Hanover. In addition to the regular order of business the subject of "Loaning Wagons" was discussed. The consensus of opinion was that the practice of lending a wagon to a customer while repairs are being made is an abuse which should be discouraged as much as possible, but it was agreed that it would be difficult to put a stop to the practice. Dinner was served after the meeting.

ST. LOUIS VEHICLE DRAFTING CLASS

The vehicle drafting class in the St. Louis public schools will resume its studies the middle of October. In addition to mechanical drafting, geometry and a manual training department are to be a part of the course this term. There is quite an interest developing in this branch of the school work, and a large enrollment is anticipated.

HORSE SET TREAD STANDARD

The first motor cars were built horse size. Horses were a certain height and to drive them the seats had to be a certain height. To accommodate the height the tread of the wagon or carriage had to be a certain width, and hence the road standard of 56 inches. This is a horse standard.

OBITUARY

John Bladon, veteran carriage manufacturer of Toledo, O., passed away October 6 at the home of his son, Frank Bladon, of Detroit, where he has made his home in recent years. Mr. Bladon was born 82 years ago in Raby township, Durham county, England. He located in Detroit in 1852, and the following year moved to Toledo where for many years he was engaged in the manufacture of carriages. He was a veteran of the civil war. He is survived by his wife, whom he married in 1861, a son, Frank Bladon, and a sister.

H. M. Harmon, 60, for more than 30 years a carriage maker of Youngstown, O., died September 20, after a two weeks' illness with typhoid fever and sciatic rheumatism. Mr. Harmon was born in Adamsville, Pa., and moved to Youngstown nearly 35 years ago. For 15 years he worked at his trade with the Youngstown Carriage Works. Then for two years he was employed by the Fredonia Carriage Works. He then started in business for himself, which he continued until ill health compelled him to retire. Six children survive.

Jacob Schmitt, 54, for 26 years a resident of Colorado Springs, Col., died October 3. He was a pioneer of the Pikes Peak region and for the last 19 years had conducted a carriage shop at 127 South Cascade avenue. He is survived by his widow and two sons. The body was taken to St. Joseph, Mo., for interment.

UNIVERSH

The Murphy Varnish Company has given the above name to a quality of varnish that is filling the role of much in little. The one varnish is a quick drier, easy worker, and remains undimmed and unchanged no matter what happens, except fire. This is a bit of exaggerated statement on our part, but it is proof against about all that has heretofore been so destructive to varnish. This is asking a lot of such a material as varnish, and to get away with it is an achievement.

MR. KERR MAKES A CHANGE

George W. Kerr, for a number of years body engineer of the Stevens-Duryea Company, has announced his resignation from that concern. Upon leaving, his associates and employes gave evidence of the high esteem in which he was held by presenting him with a beautiful jeweled Knights Templar charm, together with their best wishes for his future success.

WANTS

Help and situation wanted advertisements, 1 cent a word; all other advertisements in this department, 5 cents a word; initials and figures count as words. Minimum price, 30 cents for each advertisement.

PATENTS

Patents—H. W. T. Jenner, patent attorney and mechanical expert, 606 F St., Washington, D. C. Established 1883. I make a free examination and report if a patent can be had and exactly what it will cost. Send for circular.

SITUATIONS WANTED

Situation wanted as carriage painter, by an all round man in paint shop; wishes job in small custom shop in country town. Box 29, care The Hub, 24 Murray street, New York.

Wanted—Position as sales manager or salesman; 18 years active experience; familiar with credits and every detail of vehicle business. Chas. H. Kelly, care Studebaker Bros. Co., 445 Broadway, New York City.

Blacksmith foreman; 25 years experience, buggies, carriages and wagons for the trade; best credentials. P. Steinbrecher, Milan, Indiana.

FIRES

The carriage building plant of Geo. C. White & Sons, at Richmond, Va., sustained a fire loss of \$4,000 on October 5.

John Manuel's carriage factory at Gloucester, Mass., was damaged by fire on September 29.

REMOVAL

A. E. Louderbach, the well known cloth importer and dealer of New York, has changed office location from 118 Hudson street to 75 Murray street, where facilities for transacting business are much improved.

THE DIFFERENCE

A certain motor car sales for September of this year is given as 21,976. As three styles of body are made, probably the average is \$500 per car, or \$10,983,000 in money.

If the buggy averages \$80, for instance, 137,312 would have to be sold to cover the automobile money. We are told by those in the know that the production cost of the automobile we have in mind is about \$283 each. This would indicate the profit in automobiles was worth while, while the profit in buggies was once in a while.

INDEX TO ADVERTISERS

Baltimore Hub-Wheel and Mfg. Co.....	40
Backstay Machine and Leather Co.....	38
Carter, The Geo. R. Co.....	40
Central Mfg. Co.....	40
Columbus Bolt Works.....	4th cover
Correspondence School of Carriage and Motor Drafting...	39
Cumberland Hotel.....	3d cover
Dowler, Chas. L.....	40
Eberhard Mfg. Co., The.....	37
Eccles, Richard, Co.....	3
Fairfield Rubber Co.....	3
Gifford, John A., & Son.....	3
Jones & Co., Phineas.....	3d cover
Keystone Forging Co., The.....	39
Keystone Paint & Filler Co.....	3
Lawson Co., F. H., The.....	1
Masury, John W., & Son.....	2d cover
Meyer, John C., & Co.....	40
Miller Bros.	40
Mulholland Co., The.....	40
Murphy Varnish Co.....	4
National Spring & Wire Co.....	39
Payne Co., E. Scott.....	40
Pierce, F. O., Co.....	3d cover
Porter, H. K.....	3
Sheldon Axle Co.....	3
Sidney Mfg. Co., The.....	2d cover
Skinner Bending Co., The J. M.....	40
Standard Oil Cloth Co.....	2
Stewart-Mowry Co.....	4th cover
Technical School for Carriage Draftsmen and Mechanics..	38
Virginia and North Carolina Wheel Co.....	4th cover
West Tire Setter Co.....	3d cover
White-Quehl Mfg. Co.....	40
Wilcox Mfg. Co., D.....	1
Willey Co., C. A.....	1

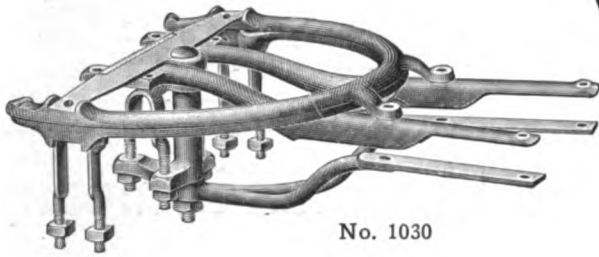

No. 1030

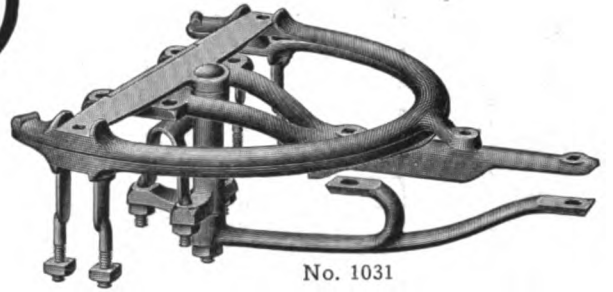

No. 1031

Malleable Iron Fifth Wheels

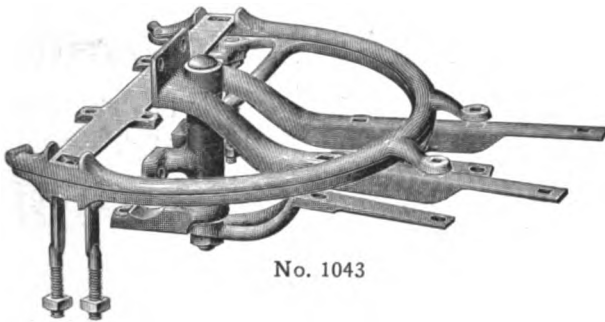

No. 1043

Made
by

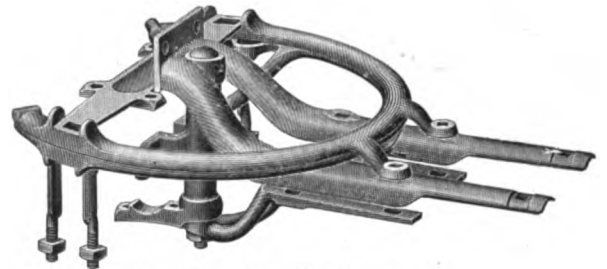

No. 1060. Parallel Perch

The Eberhard Mfg. Co.

Cleveland, Ohio

Manufacturers
of

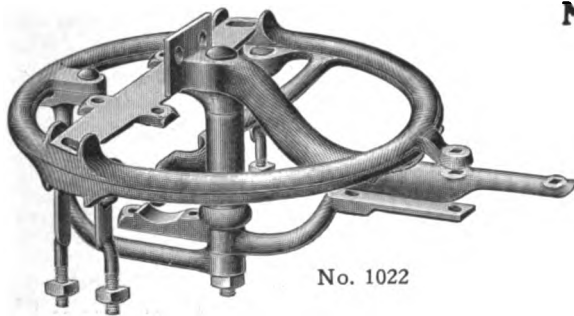

No. 1022

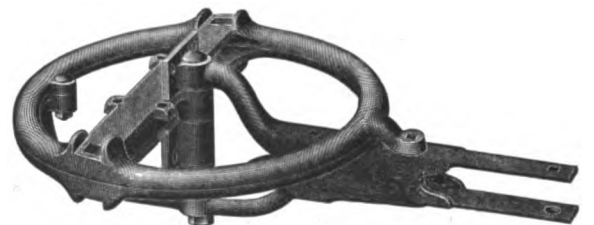

No. 875

Carriage and Wagon Hardware

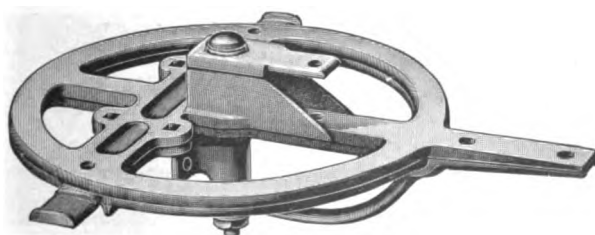

No. 890



No. 839

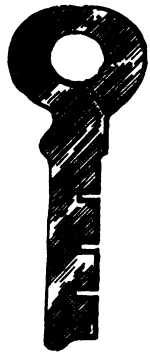

To Satisfaction on Welts and Gimps
A CUSTOMER ONCE—CUSTOMER ALWAYS

Backstay Machine and Leather Company
UNION CITY, INDIANA

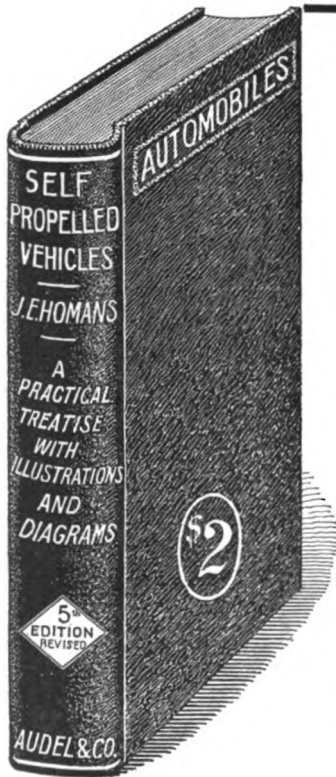

"Self-Propelled Vehicles"

Fifth Edition, Revised.

A practical treatise on the theory, construction, operation, care and management of all kinds of Automobiles.

By

JAMES E. HOMANS, A.M.

Contains 608 pages and upwards of 500 illustrations and diagrams, giving the essential details of construction and many important points on the successful operation of the various types of motor carriages driven by steam, gasoline and electricity.

This work is now the accepted standard, explaining the principles of construction and operation in a clear and helpful way. This book will be sent postpaid to any address in the United States, Mexico or Canada upon receipt of \$2.00.

Address

Trade News Publishing Co.

24 Murray Street, New York

Carriage Mechanics

Desiring to improve their present Condition should attend the

TECHNICAL SCHOOL

FOR

Carriage Draftsmen and Mechanics

SUPPORTED BY THE

Carriage Builders' National Ass'n

The object of the School is to teach men to design vehicles and make working drawings, and to otherwise facilitate their work in the shop. Only those men employed in carriage or automobile building or their accessory trades are admitted to its privileges.

The classes are conducted in three divisions, viz.: Corresponding, Day, and Evening. The former is open during the entire year, while the day and evening classes are in session only from October 1 to April 1.

The tuition is moderate.

For prospectus and full particulars, write to the instructor,

ANDREW F. JOHNSON,

20 West Forty-fourth St.,
NEW YORK CITY

Subscribe
Now for

THE HUB

\$2.00
Per Year

"BLACK VELVET" CUSHION SPRINGS

Manufactured Only by the
NATIONAL SPRING AND WIRE COMPANY
 ALBION, MICH. WINDSOR, ONT.

THE SPRING OF QUALITY.



SPRING or SOFT EDGE CUSHION FRAME
 For Buggies or Other Vehicles. Built of the Highest
 Grade of Steel Wire.

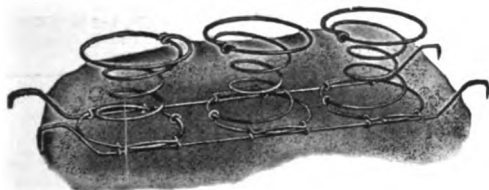

STRIP FOR WOOD OR BOX FRAME

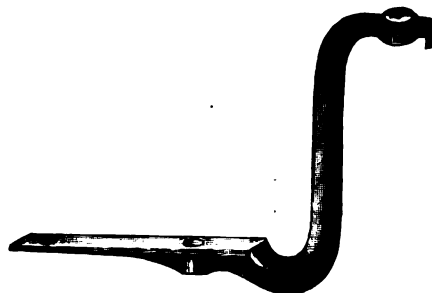

**BODY
 LOOPS**

**ALL
 SIZES
 ALL
 STYLES**

MANUFACTURED BY
The Keystone Forging Co.
 Northumberland, Pa.
 WRITE FOR PRICES

Established 1886

**Correspondence School of Carriage and Motor
 Carriage Drafting**

A thorough, practical tuition is given through this cor-
 respondence school. The theory and practice of con-
 struction, bookkeeping, perspective. Many men now hold
 good positions through taking the courses of instruction.

Principal, **THOS. MATTISON,**
 Hillside Avenue, Bitterne Park,
 Southampton, England

Author of "The Coach Body Makers' Guide," \$3.00;
 a practical treatise on "The Suspension of Carriages,"
 "Bookkeeping," and other carriage building works.

WHAT IT IS

The American Harness and Saddlery Directory
The 1914 Edition

An extra painstaking revision of the names (and other information as below) constituting the Retail
 Harness Trade, has been completed for this year's issue of the Directory, and we think the work is so
 important and worthy that the

1914 Price Is \$5 Per Copy

and it is very moderate for what is offered in a work that is

Indispensable for Reference

for copying of addresses, and for all purposes usual in a directory.

Just a Sketch of Its Contents

The list of the **WHOLESALE** and **JOBGING TRADE** is so arranged as to make it convenient to
 separate the association members from those not so recognized.

The **RETAIL HARNESS MAKERS** of the United States and Canada comprise the principal part of
 the Directory, arranged by State, Town and County, and in the large cities, the street and number is given.
 Those rating (approximately) over \$1,000 are marked.

A list of **HARNESS DEALERS** as distinguished from retail harness manufacturers, is also given. The
 value of this list to those who solicit the vehicle, implement, hardware and department stores will be
 readily appreciated.

A list is also published of Export Commission Merchants, giving the class of merchandise they handle.

PUBLISHED BY

THE TRADE NEWS PUBLISHING COMPANY

PUBLISHERS OF "HARNESS"

24-26 MURRAY ST., NEW YORK

BUSY BUYERS BRIEFS

JOHN C. MEYER & CO.
THE
LOWELL THREAD
MILLS
 MADE SEWING THREAD AND SPINNING
 BEST IN THE WORLD
LOWELL, MASS. U.S.A.

Baltimore Hub-Wheel & Mfg. Company
 Manufacturers of
Wheels AUTO MOTOR CAR
 CARRIAGE
 WAGON
Also SPOKES and RIMS
 Factory: Harford Ave. and B. & O. R. R.
BALTIMORE MD.

CHARLES L. DOWLER
 CARRIAGE AND WAGON HARDWARE
 108 North Third St., Philadelphia, Pa.
CUSHION MANUFACTURER
 Pure Stearic Acid Candles. Wheel Stock. Snow
 Flake Axle Grease.

MULHOLLAND
BUGGY SPRING
 Reduces weight of springs one-half.
 Made in one size only but will fit bodies
 of all widths.
 Write for further particulars and prices.
THE MULHOLLAND CO. DUNKIRK, N. Y.

 **White's Brazing Sleeves**
 For applying Rubber Tires
 Send for Samples.
 LINED
 **WHITE-QUEHL MFG. CO.**
 431 E. Pearl St.
CINCINNATI, OHIO
 UNLINED

Automobile and Carriage Leathers,
Leather Welts and Gimps
All Kinds of Leather Specialties
 WRITE US FOR PRICES
THE GEO. R. CARTER CO.
CONNERSVILLE, IND.

STEEL SEATS AND BODIES
 Not a Weld, Joint or Seam
CENTRAL MANUFACTURING CO.
CONNERSVILLE, IND.

AUTOMOBILE
Bodies AND CARRIAGES
IN THE WHITE
Estimates Furnished on Special Designs
MILLER BROTHERS
Amesbury, Mass.

E. SCOTT PAYNE CO.
Carriage and Automobile
HARDWARE
Horse - Shoers' Supplies
 362-364 North Gay St., Baltimore, Md.

 One of the oldest and
 largest Rim Plants in
 the world.
BENT RIMS
 For Carriage and Wagon
 Wheels
 For Automobile Wheels
 We make prompt deliveries in
HICKORY and OAK RIMS.
THE J. M. SKINNER BENDING CO.
 Toledo, Ohio

Results always follow
advertising in
THE HUB

It Pays
Others

It Should
Pay You

"TRIUNE" COLOR VARNISH

Is strictly a Varnish Product possessing color with the power to Cover in one Coat. It works as freely as straight varnish and will "flow," "level," "rub," "moss" and exhibit in general full durable qualities and working properties.

THREE QUALITIES IN ONE PRODUCT

1—Color. 2—Power to cover in one coat. 3—Straight varnish working properties and qualities. Nothing like enamel or gloss paints. Different, distinct.

Sole Manufacturers

F. O. Pierce Company, New York City
12 West Broadway

HOTEL CUMBERLAND NEW YORK

BROADWAY AT 54TH STREET

Near 50th St. Subway Station
and 53d St. Elevated.

"Broadway" cars from Grand
Central Depot pass the door,
also 7th Avenue cars from
Pennsylvania Station.

New and Fireproof

Best Hotel Accommodations
in New York at Reasonable
Rates.

**\$2.50 with bath
and up**

European Plan

All Hardwood Floors and
Oriental Rugs

**Ten minutes' walk to
40 Theatres**

Excellent Restaurant
Prices moderate

Send for Booklet



HARRY P. STIMSON, Formerly with Hotel Imperial

Only New York Hotel window-screened throughout

1855—Standard for 59 Years—1914

Jones Wheels

"Best on Earth"

The Name of Jones as Applied to Wheels Means the
First, Last and All-the-Time Word in Wheels

"Kantsamore"

Buyers of vehicles should say, "Give me wheels made by

Phineas Jones & Co.

NEWARK

NEW JERSEY

U. S. A.

The WEST Hydraulic Tire Setter

WILL CUT DOWN EXPENSE

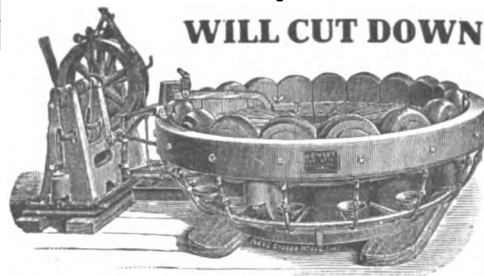

Tires set cold in
one minute. This
machine saves time
—does the work
better and quicker,
does a way with
burned streaks. On-
ly necessary to
measure one wheel
in a lot. Does not
char the rim, and
thus make the tire
loosen prematurely.

Saves resandpapering of wheels. This machine is now increasing the
profits of many manufacturers. Send for catalog and read about it.

WEST TIRE SETTER CO.,

ROCHESTER, NEW YORK

BENT RIMS Hickory Second Growth and Forest Hickory
All Grades

OAK—STAR BRAND

SPOKES Second Growth Hickory—Finished and Club Head

SUITABLE FOR ALL VEHICLES, INCLUDING AUTOMOBILES

VIRGINIA AND NORTH CAROLINA WHEEL CO.

8 Bridge Street, New York City

RICHMOND, VIRGINIA

THIS TRADE MARK MEANS MUCH TO VARNISH USERS

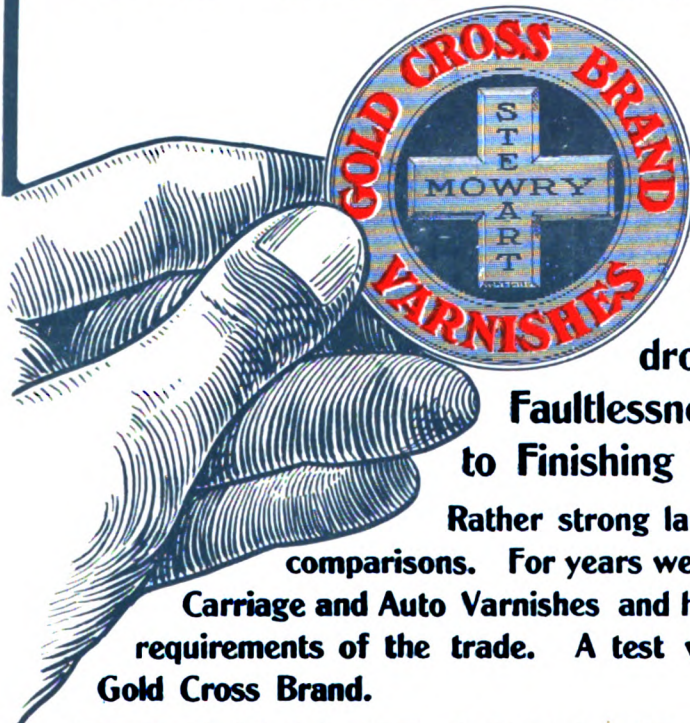

It signifies Quality. It is placed only on the best line of Varnishes we make---our Gold Cross Line.

We stake our reputation on every drop that bears this brand. It implies Faultlessness, and has no superior from Japan to Finishing Varnish.

Rather strong language—but we can prove it; and we court comparisons. For years we have been making the most complete line of Carriage and Auto Varnishes and have put some very intensive study into the requirements of the trade. A test will convince you of the superiority of the Gold Cross Brand.

STEWART-MOWRY CO., CHICAGO, ILL.

Skewed Shaft Couplings

**Regular or Oval Patterns
For High Arched Axles**

Furnished in rights and lefts for any height of arch. Oval Axle Clips $\frac{5}{8}$ or $\frac{3}{4}$ width to match Oval Couplings. Bolts, Clips, Couplings, Carriage Hardware and Special Forgings

Catalogue "H" and Prices on Application

COLUMBUS BOLT WORKS, Columbus, O.

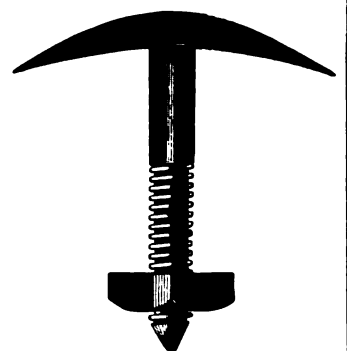
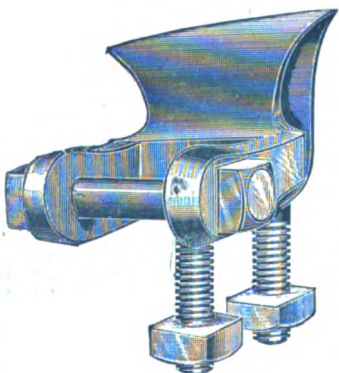

The Hub



TRADE NEWS PUBLISHING COMPANY
24-26 MURRAY ST. NEW YORK

"BLACK VELVET" CUSHION SPRINGS

Manufactured Only by the

NATIONAL SPRING AND WIRE COMPANY

ALBION, MICH. WINDSOR, ONT.

THE SPRING OF QUALITY.



SPRING or SOFT EDGE CUSHION FRAME
For Buggies or Other Vehicles. Built of the Highest
Grade of Steel Wire.

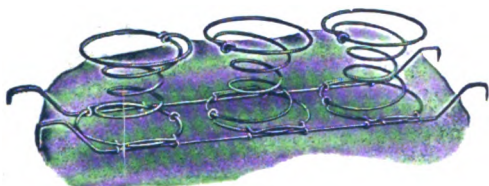

STRIP FOR WOOD OR BOX FRAME

THE F. H. LAWSON CO.

CINCINNATI, O.

Manufacturers of

LAWSON'S METAL BUGGY SEATS

FLEUR DE LIS PATTERN

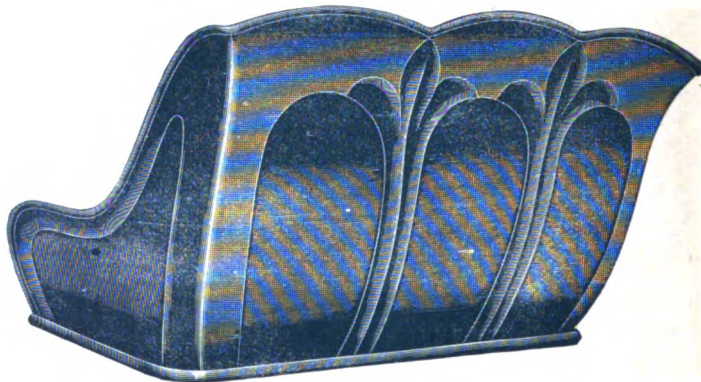

**NEW STYLES—ALL SIZES—STRONGEST—
NEATEST—BEST**

No Solder Used

YOUR VEHICLE SELLS WHEN EQUIPPED WITH

LAWSON'S METAL SEATS

Write for Prices

JOHN W. MASURY & SON

Originators of

Superfine Coach and Automobile Colors

Acknowledged the Standard for Fifty Years

AND MANUFACTURERS OF

Fine Carriage and Automobile Varnishes

New York,

Chicago,

Minneapolis,

Kansas City



SHERWIN-WILLIAMS
VEHICLE FINISHES

A PRODUCT FOR EVERY PURPOSE, PRODUCING DISTINCTIVE RESULTS

S-W METAL PRIMERS S-W BODY AND GEAR UNDERCOATINGS
S-W Q. D. COLORS S-W COLOR VARNISHES
S-W FINISHING VARNISHES

EFFICIENT IN QUALITY AND UNIFORMITY

The SHERWIN-WILLIAMS Co.

CLEVELAND CHICAGO NEWARK MONTREAL LONDON, ENG.

WILCOX **F**INE
FINISHED
ORGED

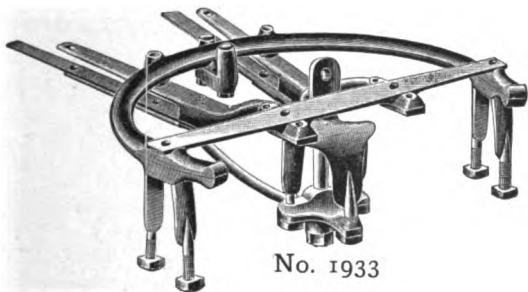

No. 1933

**Carriage Hardware
and Gear Irons**

Write us for Catalogue No. 11B

The D. Wilcox Mfg. Co.

**MECHANICSBURG,
CUMB. CO., PA.**

WILLEY'S COLORS

The **RECOGNIZED STANDARD**



C. A. WILLEY CO.

COLOR GRINDERS

and Manufacturers of Specialties in

CARRIAGE, AUTOMOBILE AND CAR

PAINTS

COLORS, VARNISHES, ETC.

HUNTER'S POINT, NEW YORK CITY

Established 1886

Correspondence School of Carriage and Motor Carriage Drafting

A thorough, practical tuition is given through this correspondence school. The theory and practice of construction, bookkeeping, perspective. Many men now hold good positions through taking the courses of instruction.

Principal, **THOS. MATTISON,**
Hillside Avenue, Bitterne Park,
Southampton, England

Author of "The Coach Body Makers' Guide," \$3.00;
a practical treatise on "The Suspension of Carriages,"
"Bookkeeping," and other carriage building works.

SUBSCRIBE NOW FOR

THE HUB

\$2.00 PER YEAR

WHAT IT IS

The American Harness and Saddlery Directory

The 1914 Edition

An extra painstaking revision of the names (and other information as below) constituting the Retail Harness Trade, has been completed for this year's issue of the Directory, and we think the work is so important and worthy that the

1914 Price Is \$5 Per Copy

and it is very moderate for what is offered in a work that is

Indispensable for Reference

for copying of addresses, and for all purposes usual in a directory.

Just a Sketch of Its Contents

The list of the **WHOLESALE** and **JOBGING TRADE** is so arranged as to make it convenient to separate the association members from those not so recognized.

The **RETAIL HARNESS MAKERS** of the United States and Canada comprise the principal part of the Directory, arranged by State, Town and County, and in the large cities, the street and number is given. Those rating (approximately) over \$1,000 are marked.

A list of **HARNESS DEALERS** as distinguished from retail harness manufacturers, is also given. The value of this list to those who solicit the vehicle, implement, hardware and department stores will be readily appreciated.

A list is also published of Export Commission Merchants, giving the class of merchandise they handle.

PUBLISHED BY

THE TRADE NEWS PUBLISHING COMPANY

PUBLISHERS OF "HARNESS"

24-26 MURRAY ST., NEW YORK

SHELDON AXLES AND SPRINGS

**For Horse-Drawn and Power-Propelled
Vehicles of All Kinds**

JUST ENOUGH BETTER THAN OTHERS TO BE NOTICEABLE

When you specify "Sheldon" you are not experimenting with experiments, but are getting Axles and Springs with years of manufacturing experience back of them—Axles and Springs that are selected for important work where conditions make reliability supremely important

SHELDON AXLE AND SPRING COMPANY, WILKES-BARRE, PA.

LARGEST AXLE AND SPRING FACTORY IN THE WORLD

PORTER'S BOLT CLIPPERS

"Easy" "New Easy" Allen-Randall



To Cut 5-16, 3-8, 1-2, 5-8, 3-4 inch.

H. K. PORTER,

EVERETT, MASS.

Richard Eccles Co., Auburn, N.Y.

Manufacturers of

Forgings: Carriage, Wagon, Automobile' Special

Send for Catalogue No. 18;

Also Catalogue of Special Automobile Forgings



THE FAIRFIELD RUBBER COMPANY

Manufacturers of

**Carriage Cloth, Imitation Leather,
Automobile Cloths, etc.**

FAIRFIELD,

CONNECTICUT

KEYSTONE BLACK FILLER

MAKES A PERFECT

ROUGHSTUFF

For Automobile Bodies and Parts

It fills the pores of Metal and Wood perfectly. Sandpapers easily and produces a fine, smooth surface that DOES NOT CRACK, SCALE NOR PEEL.

POMEROY & FISCHER, New York
Selling Agents to Vehicle Trade

KEYSTONE PAINT AND FILLER CO., Muncy, Pa.

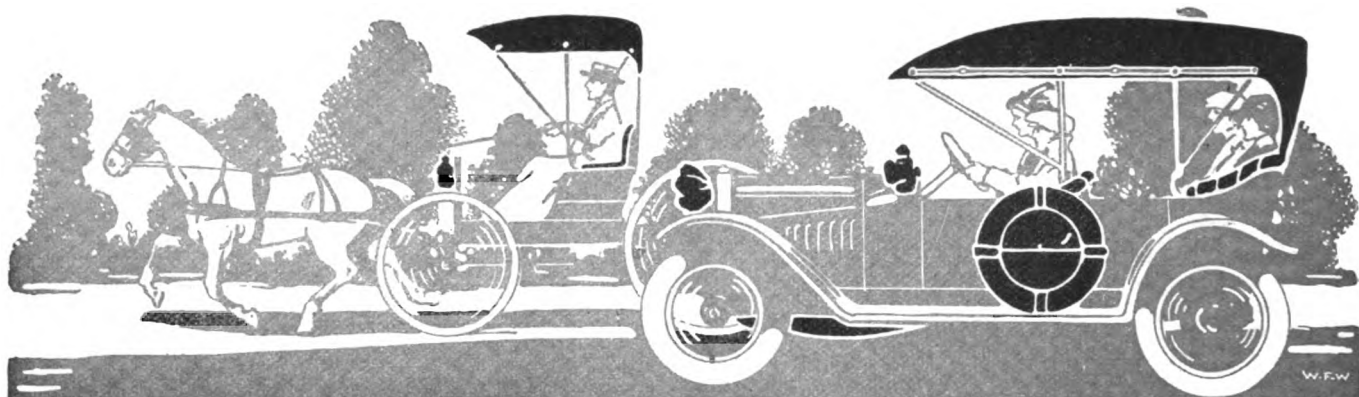

Learn More About The Leading Leather Substitute

Every carriage and automobile manufacturer—every manufacturer of carriage and auto accessories, storm curtains, aprons, lamp covers, tire cases, trunks, etc., should get and examine samples of

MERITAS LEATHER CLOTH

Only by seeing the goods—by testing them—by noting the handsome, durable, non-cracking finish and the fine line of colors can you appreciate the high quality we have attained in the manufacture of a serviceable leather substitute.

There are styles, colors and finishes in MERITAS LEATHER CLOTH suitable for every carriage and auto trimming and upholstery purpose.

It can be had in muslin, duck and drill; dull or glazed; smooth or grained; in black and colors.

Sample book on request—write now and know more about the leading leather substitute.

Write
for
sample
book of
MERITAS
LEATHER CLOTH

NOW

Standard Oil Cloth Co.

320 Broadway, New York

THE TRADE NEWS PUBLISHING CO. OF N. Y. Publishers of THE HUB

J. H. WRIGHT, *President* G. A. TANNER, *Secretary and Treasurer*
24-26 MURRAY STREET, NEW YORK

Other Publications of Trade News Publishing Co.:

HARNESS (monthly).....per year, \$1.00
AMERICAN HARNESS AND SADDLERY
DIRECTORY (annual).....per copy, \$5.00

THE HUB is published monthly in the interest of employers and workmen connected with the manufacture of Carriages, Wagons, Sleighs, Automobiles and the Accessory trades, and also in the interest of Dealers.

Subscription price for the United States, Mexico, Cuba, Porto Rico, Guam the Philippines, and the Hawaiian Islands, \$2.00, Canada, \$2.50, payable strictly in advance. Single copies, 25 cents. Remittances at risk of subscriber, unless by registered letter, or by draft, check, express or post-office order, payable to the order of THE TRADE NEWS PUBLISHING CO.

For advertising rates, apply to the Publishers. Advertisements must be acceptable in every respect. Copy for new advertisements must be received by the 25th of the preceding month, and requests to alter or discontinue advertisements must be received before the 12th day of the preceding month to insure attention in the following number. All communications must be accompanied by the full name and address of writer.

FOREIGN REPRESENTATIVES:

FRANCE—L. Dupont, publisher of *Le Guide des Carrossiers*, 78 Rue Boissiere, Paris. Subscription price, 15 francs, postpaid.

GERMANY—Gustave Miesen, Bohn a Rh. Subscription price, 12 marks, postpaid.

ENGLAND—Thomas Mattison, "Floriana," Hillside avenue, Bitterne Park Southampton. Subscription price, 12 shillings, postpaid.

Entered in the New York Post Office as Second-class Matter

Cause for Rejoicing

The enormous increase in the aggregate value of the farm yields of 1914, spite of the sharp loss in cotton caused by the war, undeniably means better times ahead. Coincident with the operation of the new Federal banking system and the straightening of the international exchanges, the evidence of cessation of agitation against business interests and more favorable consideration of the railroads' case, this bountiful harvest must inspire each and all. That we should produce so heavy an exportable surplus of foodstuffs at a time of European shortage in the midst of war means a strong effort toward adjustment of the financial and commercial situation in the United States. Clearly, the corner of depression has been rounded and we may look forward with confidence to more hopeful business.

We are not out of the woods yet, but among the clear signs of improvement the great 1914 harvests loom large—it is the correct economic basis for genuine improvement, this great crop. The potential buying power thus created is great; granted return of confidence, readjustment in financial arrangements, an irresistible force will

come from the replenishing of depleted stocks of merchandise.

The temporary cotton loss is more than offset by the record-making cereal yields and the high prices resulting from European demand. The Department of Agriculture places the value of our farm crops this year in excess of five billions, and, in spite of over four hundred millions loss in cotton, the total runs over one hundred millions ahead of 1913. This is a remarkable exhibit of prosperity's basis, a great demonstration of our country's splendid abilities.

With agricultural success and what it means of buying power, with straightening of financial affairs and establishment of sound credit conditions, the beginning of revival may be foreseen. Our export trade is gaining well, and with savings in the usual annual bills to Europe for freights, travelers' expenditures and remittances generally, the meeting of balances due from us may be accomplished successfully, spite of the great volume of our securities held abroad and withheld from liquidation by the prudent handling of the American financial situation whereof the closed Stock Exchange is a vital necessity.

Without going so far as to say that our remarkable harvests of 1914 spell immediate or even early return of general business to what we call normal, it is plain that they do call a halt in pessimism and do give cause for rejoicing and for renewed courage.

Fortune in the Clouds

Manufacturers who were confronted with a shortage in dyestuffs at the outbreak of war, owing to the fact that we are dependent so largely on foreign countries for them, will find food for thought in an article by George H. Cushing, in the *Technical World* magazine. He declares:

"All of the anilin dyes are by-products of coal. Chicago, Pittsburgh, Cincinnati and Cleveland belch great vats of gorgeous colors into the air daily and then send all the way to Germany to buy a supply."

American genius surely can do what German genius has done in this matter! There is no longer the excuse that "Germany does it so much cheaper," for Germany has stopped doing such things, almost altogether.

Philip D. Armour used to say, "We shall see larger fortunes made out of the things that are now thrown away."

Who shall say that "the days of great opportunities

have passed away," when even the smoke clouds over our cities offer fortune for those who have ability and courage to reach out and take it?

It is estimated in Paris that six billion dollars represents the French losses in real estate, houses, furniture, workshops, mines, railroads, public roads, and public monuments since the beginning of the war. To this add the money loss in Belgium and you will see what carrying the war into the enemy's country means.

PRESENT CONDITIONS IN ARGENTINA

Consul General L. J. Keena, Buenos Aires, under date of September 14, writes as follows: Purchases in foreign markets are few and are being cautiously made. The general feeling is that the country has no money to spend for the present and must get along as far as possible with the available supplies. Coal is the one great exception. Interest in American-made goods is unprecedented. The trade indexes and lists of manufacturers on file at this office are in almost constant use by importing agents and manufacturers' representatives who are seeking lines to replace those formerly purchased in Europe. It must be understood, however, that these men are rarely in immediate need of goods and that their necessity is not such that they will blindly order from a list of manufacturers or from catalogs given them. They realize that they must establish new commercial connections and desire to do this intelligently before it becomes necessary for them to restock.

On September 17 the Lamport & Holt Line steamship Vauban will leave this port for New York. This will be the first of this line since August 15. The Lamport & Holt Line promises that beginning with September 17 it will have regular weekly sailings to and from New York for passengers and freight. Other lines also state that their service will be regular in the future. These regular lines, together with other steamers that may be attracted to the South American east coast routes, should insure prompt deliveries of American merchandise, and, what is equally important, of American mails.

As to the question of credits, while it is true that locally cash transactions have prevailed during the past six weeks, that practice is regarded as only temporary. Further, it is one thing to pay cash for goods warehoused here and quite another to deliver cash against documents in the United States, which would mean a payment of 40 days in advance of the time when the goods could be received and cleared from customs here.

The public statements of prominent officials and individuals in the United States relative to a liberal credit policy on South American sales have been widely copied in the local press and most favorably commented upon. The feeling is also freely expressed that the country has heretofore enjoyed most liberal credits from Europe and that the fact that it has not abused them should be a basis of credit for it with any friendly country. The type of credit extending from six months to two years formerly granted by some European houses, is not solicited nor is it approved by substantial business houses, as over-long credits tend to encourage pure speculation. According to the impression of this office a 90-days' dating with suitable discounts for earlier payments would not only be acceptable to the local trade, but would strongly influence the establishing of cordial relations.

This much can be reasonably forecasted, namely, that a general policy of cash against documents in the United States (which is now in many instances being followed) will mean temporary buying in American markets, not from choice but from necessity; but such buying will be only temporary and purchasing will revert to European markets at the first opportunity, whereas a policy of liberal credit extension, with a maximum of 90 days, backed by the acknowledged quality of

American goods, would result in established and well-cemented commercial relations between the United States and Argentina.

An American credit-rating firm has a branch in Buenos Aires, and the branch of the National City Bank of New York at present being established intends to organize a special credit service for Argentina.

COUNTY AID TO ROAD BUILDING

With the object of gathering data that will help county and township officers to determine the best way of financing their local road improvements, the Office of Public Roads of the United States Department of Agriculture has just published, under the title, "Highway Bonds" (Bulletin No. 136), an analysis of the economic features affecting the construction and maintenance of highways financed by bond issues.

The bulletin, which consists of 91 pages of text, with a number of maps and plates, gives complete tables of costs of various types of roads and the amounts of bond issues, as the result of inquiries addressed to county officers of all the counties, which brought definite returns from 1,230 counties. These led the office to fix the total amount of highway and bridge construction bonds issued by counties and townships up to January 1, 1914, at \$287,031,018. In addition, the bulletin gives elaborate tables and charts whereby county officers can determine the total cost and annual appropriation necessary for constructing different highways by bond issues.

The investigation shows that January 1, 1913, slightly over \$202,000,000 in bonds were outstanding. During the past three years, county, district and township highway and bridge bonds were voted as follows:

1911.....	\$29,200,022
1912.....	31,793,274
1913.....	50,655,554

Total for three years.....\$111,648,850

Up to January 1, 1914, there had also been voted state highway bonds to the amount of \$158,590,000, which makes a grand total of all highway bonds voted and reported to the Office of Roads January 1, 1914, of \$455,621,018, or very nearly a half billion dollars of state and county money expended or to be expended on highway and bridge improvements.

While many counties did not report the term of the highway bond issues, it was found that the mean term for approximately \$47,000,000 issued prior to 1913 was 24.8 years. The issues of 1912 and 1913 which were studied indicated that bonds maturing in 20 years or less, or else retired under the serial payment plan, were more popular than those running over 20 years.

In speaking of bond conditions, the authors of the bulletin state that inasmuch as probably over 80 per cent. of local bonds for highways and bridges are still outstanding, the highway bond movement has yet to meet the test of repayment, and that the maximum outlay for the retirement of outstanding highway loans will apparently be reached in about 20 years.

The continued success of highway bonds as a means of road improvement will depend largely, the authors point out, on whether or not the county authorities follow the following principles of sound road financing:

(a) A steady and well administered system of meeting interest and providing for the retirement of bonds on maturity, whether by means of a sinking fund, by the annuity method, or through serial payments.

(b) The limiting of expenditures for road improvements to sums which are warranted by the actual saving in cost of hauling that the road improvement will effect. In this item may also be considered increased tonnage which follows road improvement.

(c) Expending bond moneys only on roads of such a character that a satisfactory share of this money may be regarded as a permanent improvement. This means that the bond issue should not be spread so thin over an exorbitant mileage that

the improvement will be largely superficial and practically disappear in a very short time.

This means, also, that a large percentage of the bond issue should go into building a satisfactory and permanent foundation for the road which would call principally for resurfacing repairs, rather than frequent complete reconstruction.

(d) Provision for proper maintenance and repair of a bond-built road throughout the life of the bonds, so that when bonds are retired the county will still have an actual and valuable property to show for its expenditures.

(e) Limiting the term of bonds so that the life of the bond will not exceed the life of the improvement.

PACIFIC COAST MOTOR HIGHWAY

In addition to the great Canadian automobile highway now in course of construction from the Atlantic to the Pacific, of which Vancouver is the western terminus, the Pacific coast highway extending from San Diego to Alaska via Vancouver is being linked up, and by the end of 1915 motorists will be able to make the trip from southern California to British Columbia over a hard-surfaced road. The route will include the principal cities on the coast and will afford one of the most attractive motor trips on the continent.

There has been great activity in road building in California, Oregon and Washington, and several thousand miles of fine roads have been added to the highways in those states in recent years. Various sections of the Pacific coast highway have been linked up in the states mentioned, and it is now possible to make the trip by motor for most of the distance from San Diego to Seattle.

Approximately \$7,000,000 was spent on road building in British Columbia in 1913, and every settled section of the province is being provided with good roads. As practically all the original transportation routes in this district were from east to west, especial attention is now being given to the building of north and south lines of both highways and railroads. The purpose is to open up lines of coastwise communication connecting the main arteries of traffic extending from the eastern and central provinces to the Pacific coast. This is especially true of motor roads, and at the present rate of progress in construction British Columbia will soon be provided with highways suitable for motor traffic from the border of the United States to Yukon territory.

That portion of the British Columbia section of the Pacific highway from Vancouver to Blaine, Wash., was recently definitely marked, and other divisions in the province are being connected. For several years various sections of good motor roads along the coast have been in use, but only within the last few years has there been a concerted effort to connect the completed divisions, making one continuous highway through the Pacific coast states and British Columbia.

The plan of the Pacific Coast Highway Commission, which initiated and has been the moving factor in the construction of a motor trail along the Pacific coast, is ultimately to include Yukon territory and Alaska in the route.

The engineers detailed by the Alaskan Road Commission to survey the proposed government highway from Skagway to the summit of the White Pass have completed the work and are now preparing maps and data for the route. The road is to connect at the international boundary line at the summit of the pass with the Canadian system of roads reaching to the Atlin section, and to Yukon as far north as Dawson. The road from Skagway to the summit will have a grade averaging less than 5 per cent, and at no place will it exceed 8 per cent.

According to the new survey the route follows for the greater part of the distance the old '97 trail, leaving out that section of the road leading to Black Lake, but continuing on the west side of the Skagway River to Rocky Point, avoiding the long, steep grade to Black Lake.

With the completion of this route motorists living in any

section of the coast country will be able to make the journey from southern California to Alaska with such side trips as they may desire to include.

J. M. STUDEBAKER CELEBRATES 81ST BIRTHDAY

J. M. Studebaker, last of the family of five brothers who developed the biggest vehicle business in the world, celebrated his 81st birthday on the 10th of October, at South Bend, Ind. Mr. Studebaker does not look like a man who has completed four score and one years, his eye is clear, and his face and bearing, together with his healthful color, give him the aspect of a considerably younger man. He is keenly alive to all the affairs of current history and keeps up an active interest in all matters relating to the vast Studebaker organization.

Despite his advanced age, Mr. Studebaker is at his office in the factory every day, usually arriving at seven o'clock in the morning, in advance of most of his 5,000 employees.

DOES NOT BUILD STORM BUGGIES

On page 10 of the September issue of *The Hub* was shown a cut of a storm buggy as the season's leader of the F. A. Ames Co., of Owensboro, Ky., which should have been credited to the Union City Carriage Mfg. Co., of Union City, Ind. The mistake is all the more annoying because the F. A. Ames Co. does not build storm buggies. Several good customers have asked the company to build a storm buggy but it has continually declined to do so.

GROWING OLD

Dr. A. V. Barnes, in *Christian Advocate*

A little more tired at the close of day,
A little less anxious to have our way;
A little less anxious to scold and blame,
A little more care for a brother's name;
And so we are nearing the journey's end,
Where time and eternity meet and blend.

A little less care for bonds of gold,
A little more zest for the days of old,
A broader view and a saner mind,
And a little more love for all mankind;
And so we are faring down the way
That leads to the gates of a better day.

A little more love for the friends of youth,
A little more zeal for established truth;
A little more charity in our views,
A little less thirst for the daily news;
And so we are folding our tents away
And passing in silence at close of day.

A little more leisure to sit and dream,
A little more real the things unseen;
A little nearer to those ahead,
With visions of those long loved and dead;
And so we are going where all must go,
To the place the living may never know.

A little more laughter, a few more tears,
And we shall have told our increasing years.
The book is closed, and the prayers are said,
And we are part of the countless dead.
Thrice happy, then, if some soul can say,
"I live because he has passed my way."



MARTELL BODY BUGGY
Built by Durant-Dort Carriage Co., Flint, Mich.

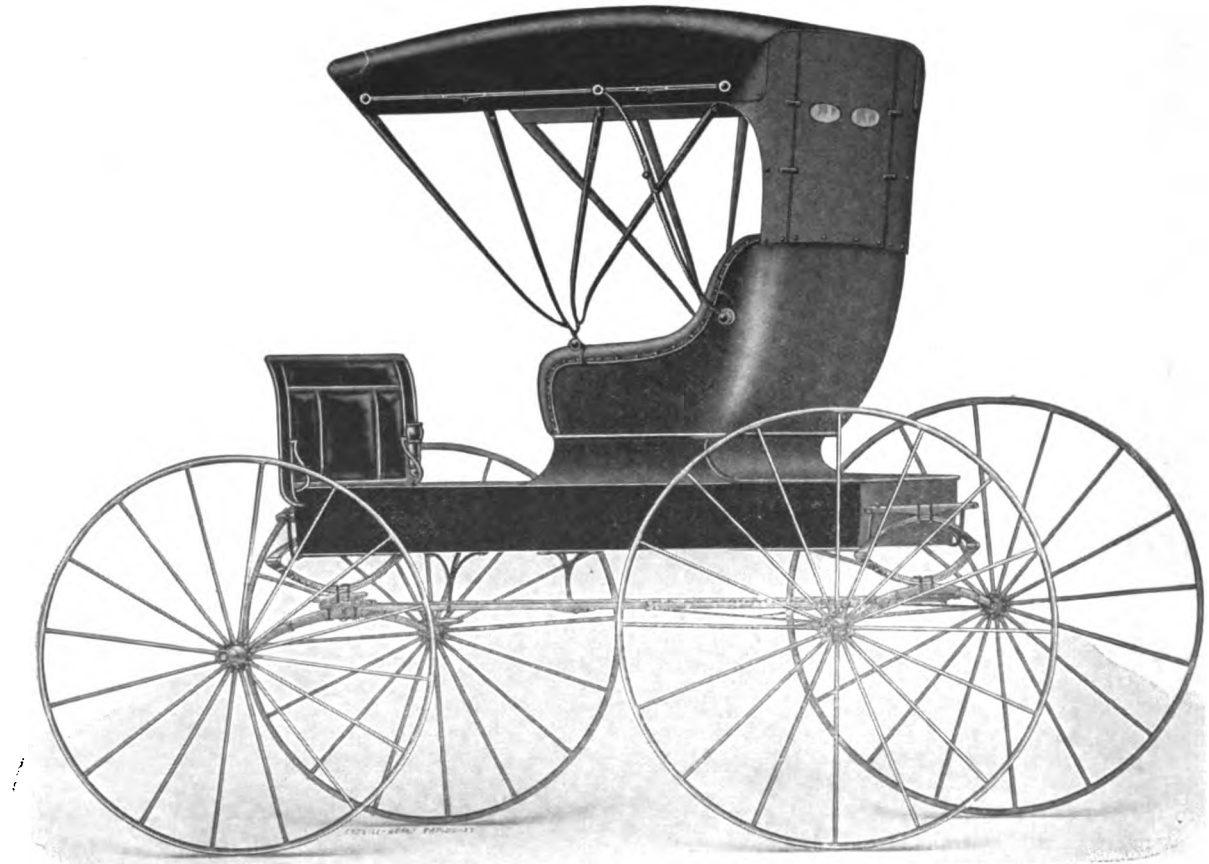

LIMOUSINE SEAT TOP BUGGY
Built by Peerless Buggy Co., Springfield, Ill.

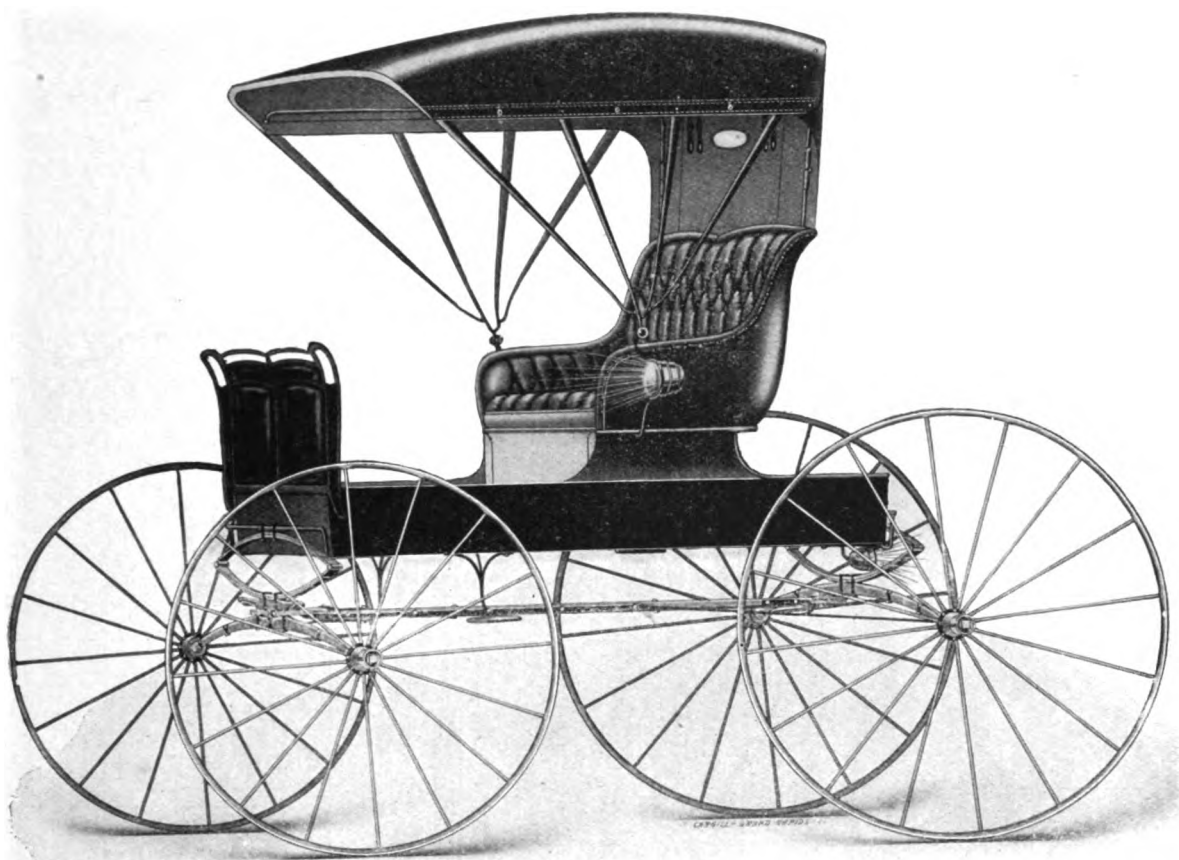

THE EMERSON AUTOCRAT BUGGY
Built by Emerson-Brantingham Co., Rockford, Ill.

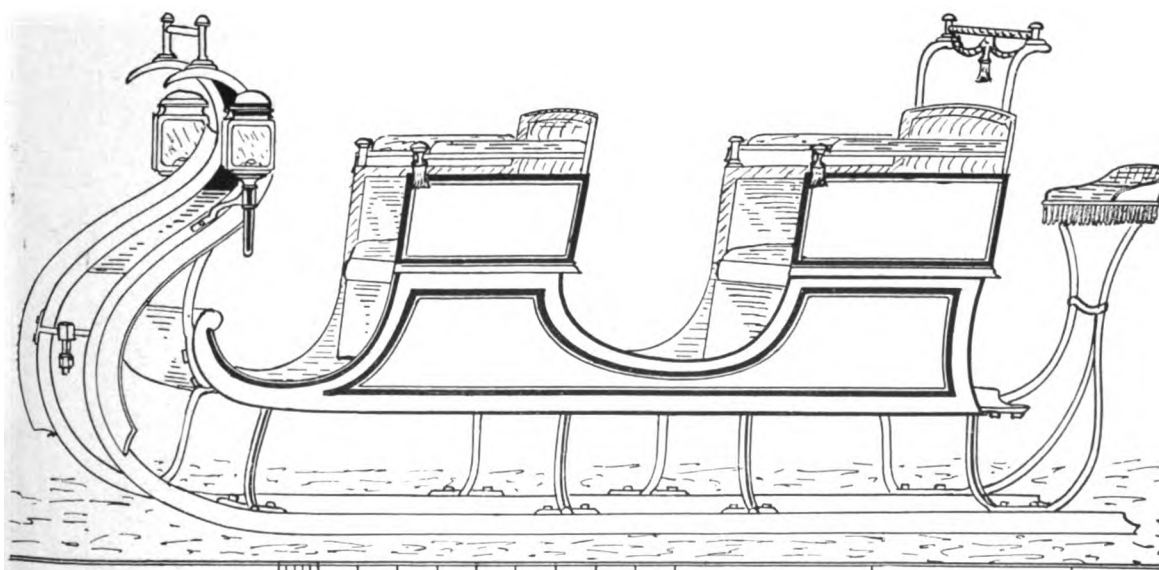

A GERMAN SLEIGH
Drawing from Deutschen Sattler-Zeitung

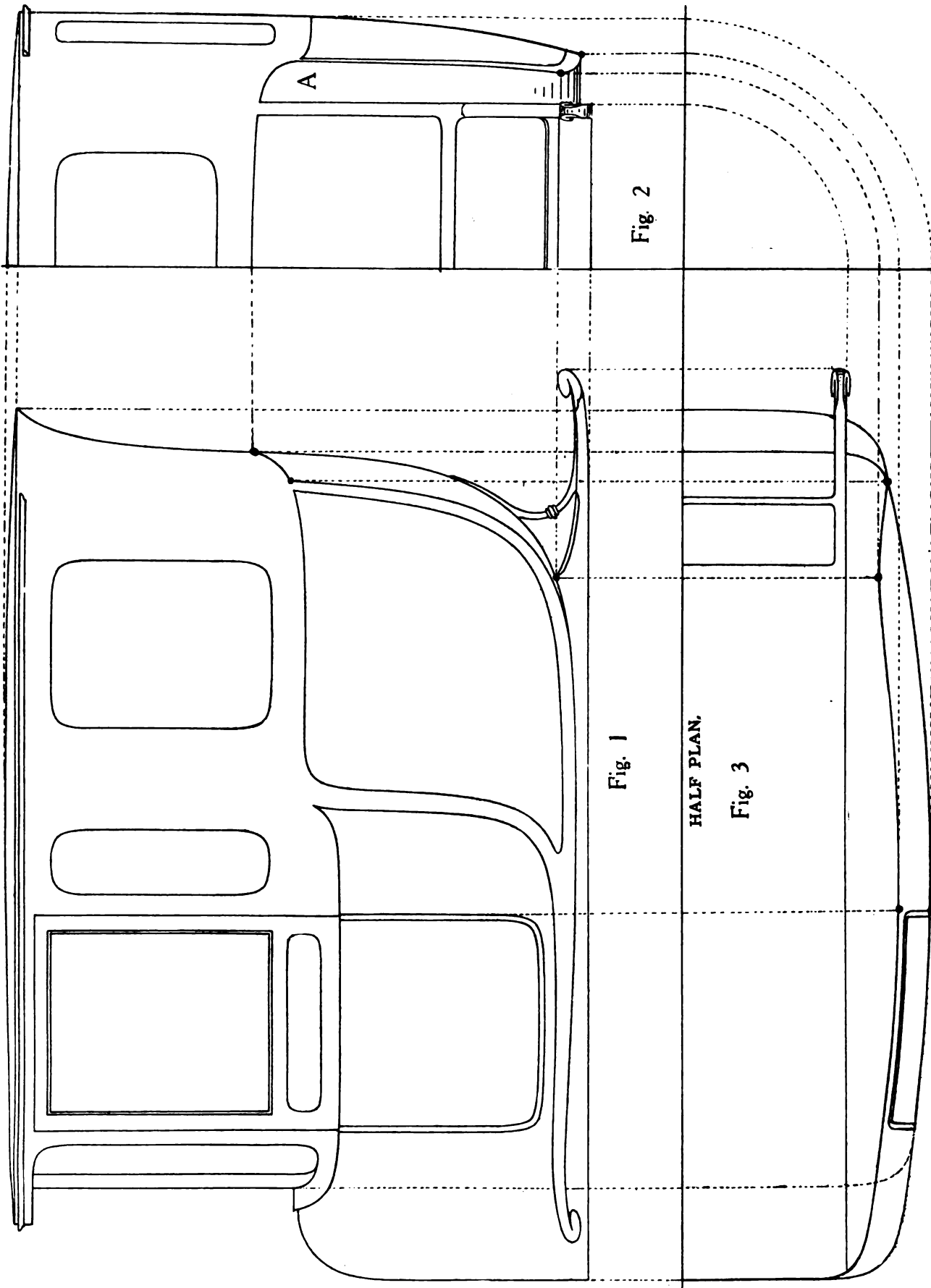

CABRIOLET LIMOUSINE MOTOR BODY
Description opposite page

CABRIOLET LIMOUSINE MOTOR BODY

In the luxurious rank of motor vehicle production the limousine holds a distinctive place, and quite as unique as that of the brougham in horse-drawn carriages.

The shows, or exhibitions, that are annually held in London and Paris furnish us with the position in motoring society of those types of body that are of exclusive patronage with the elect. With this section of the community the limousine is very popular. We cannot enter into the derivation of the body's title, or unravel its meaning, but in the absence of this we may safely put it down to mean spacious, roomy, and we may be pardoned if we coin a word and say "saloonery."

The body is fashioned in many styles of outline, as most cars are without any meaning to the design, but this is a great mistake, for every design of body, whether for light or heavy work, ought to be distinctive in its character, and so give a force to position and uses they are meant to fill.

The design we present herewith is of a cabriolet hind bottom quarter, bound by a controlling ogee-corner body line, which renders a rich effect on the top quarters and lends a gondolic grace to the car when speeding along the high courses of fashion and country.

The composite of the design shows a rich blending of the law of continuity, as demanded by the exactions in the law of curvature.

But in this particular body designing is, alas, a dead letter. Would-be mentors in England, whose conceit and ignorance of the laws of design, with knowing wisdom advocate a good schooling in free hand drawing, which, of course, is excellent, but the object of technical education is to impart the theory or science of craftsmanship, to show workmen by direct application the truth and reason of things. Free hand drawing tells you nothing, other than giving a refining and mobile movement to the hand, while the law of curvature holds the scholar to the truth of lines and teaches how to impart a living force to design, for it is the art that lives, and not the mechanism.

Hence, we see such a lot of "guys" passed off under the name of design, in the output of motor bodies, which tell the tale of darkness more eloquently than the severe handling of critics.

The design we present in this issue is apportioned in its sectional spacing with a clear sense of the importance of proportion, and the lines flowed into a harmonious balance. The design is all the clearer and imposing through being in severe outline only.

The back quarter is cabrioleted and finished with a curved quarter corner pillar; the heavy quarter is thus cut up and the outline of the quarter clearly defined by the moulding which runs into the arm moulding on the bottomside line.

A front pillar moulding defines the quarter in complete form, and spaces a light quarter to harmonize with the bonnet quarter and door; thus the bottom quartering is nicely balanced in its harmony, while the top quarter is cut up in its heaviness by spacious side lights. The front body is made with top quarter side light, and fronted with the windage screen. The whole outline of the body showing a design of rich and dignified appearance, which a car of this model should signally possess.

The prevailing fashion is to avoid projecting quarters of any description, so that windage cannot attack the surfaces, but sweep the body from front to rear in a full leveling pressure. The body is in obedience to this necessity level sided, having one clean side and turnunder line sweep.

Fig. 1 shows the full design of body. Fig. 2 shows the half back section and its design, from which the half plan or "cant" of the body is projected, the turnunder of the bottom quarter, the back and the pillar quarter, back bottom quarters and top quarter are clearly defined.

The top quarter can be rounded into the covered quarter pillar or left square as in the draft, the curve of the elbow can run up the curved corner or finish at the moulding point, while

the corner can be top rounded as in the half back section at A. These points are left open as they can be followed either way as pointed out.

The half plan is developed from the elevation in points of width and curvature, while the turnunder points are projected from the half back section and defined on the half plan in star points and chain lines leading to their position on the elevation and half back section. The elevation, half section and half plan are very clearly defined, and to the practical and experienced body maker needs no other explanation than is herein given.

The sizes of body are as follows: From front quarter to extreme point of roof, 7 ft. 8 in.; full length of top quarter on elbow line, over all, 4 ft. 2 in.; projection of top quarter over elbow point, 4½ in.; length of back quarter over mouldings, 2 ft. 10 in.; depth of quarter over mouldings, 2 ft. 4½ in.; depth of rocker at this point, 1 in.; length of elbow on front quarter, 11½ in.; width of door, 23 in.; depth of door, 1 ft. 9½ in.; depth of waist rail, 7½ in.; width of front quarter, from door, 16½ in.; depth of same, 2 ft. 6½ in.; width of body on back at elbow point, 44 in.; width on turnover line at standing pillar, 47 in.; full width across standing pillar, 53 in.; depth of body from door over moulding arm and rocker, 5 in.; full length of roof of body, 7 ft. 2 in.

The chassis is 3 ft. in front and 40 in. behind. The bottomside of the body should be made wide enough to rest fully on the width of the top of the chassis. The width of the windage quarter light over all is 6½ in. from door line; depth of same, 2 ft. 6 in.; width of back quarter top light, 18 in.; depth of same, 23 in.; width of front light, 7½ in.; depth of same, 23 in.; width of door light, 19 in.; depth of same, 23½ in.

The body can be made of metal panelling or of wood in coach making style, which after all holds the field in the highest class car building for good work and rich finish in construction.

PROPOSED WITHDRAWAL OF STOPPING PRIVILEGES

Western railroads have filed notice of the intention to cancel the rules permitting the stopping of cars to complete loading or partially unload, privileges that are of the utmost importance to the agricultural implement and vehicle trade.

The traffic department of the National Implement and Vehicle Association is preparing a protest to be filed with the Interstate Commerce Commission. Suspension of the tariff from which these rules are omitted will be asked, pending a hearing. The association will then present evidence to show that the withdrawal of the privileges would be an injustice to the users of agricultural implements because it would result in higher freight charges. Less than carload rates would be collected on numerous shipments that now take the carload rates, although contributed by factories in different towns, or destined to dealers in two or more places.

The dealers' National Federation will be called upon to assist in the fight for the continuance of these privileges.

DEVELOPMENT OF THE CHEAP BUGGY

J. W. Moon, president of the Moon Motor Car Co., recently stated that it took the buggy business 20 years to develop to the point which the automobile has reached in ten years. In this connection Mr. Moon, who has been a vehicle manufacturer for 32 years, told the following interesting story of the beginning and development of low-priced buggies:

The first so-called "cheap" buggy factory was started in Cincinnati in 1873 by John Aull. Aull built the bodies and running gears and his wife did the trimming. For a year Aull disposed of his product through the Fifth street horse market in Cincinnati. Then came Louis Cook, who had the first buggy factory that was really worthy of the name. The Simmons Carriage Co. followed and Cincinnati became a hotbed of buggy

factories. Soon they began to spring up in every part of the country.

Before that time buggies were built by almost every blacksmith in towns of 2,000 population. They were sold from \$300 to \$400. At first the factories had a hard fight to dispose of their product, because of the opposition of the local buggy builders. They would ship a carload of buggies into a town and the salesmen would come along and auction them off. After the second or third trip someone in the town, usually the implement dealer, would take the agency for the buggy factory.

The industry had a mushroom growth. Factories grew and expanded too rapidly. There was too many in the business. The crash came in 1893, with the panic. That year and the two years following there were 52 failures in the buggy business in the United States. Business became stable after that and the factories that had been growing naturally stayed in the business and prospered.

The automobile industry began to be noticed in the United States in 1903 and 1904. It, too, developed rapidly and had a mushroom growth. There was a great deal of speculation in the business. A readjustment had to come and failures resulted. But, as in the buggy business, the concerns that grew normally are still in the business and will continue to be.

MOTOR CARS IN SICILY

While the sale of automobiles has increased in Sicily in recent years, says Consul Samuel H. Shank, Palermo, Italy, there are still few in use as compared with many other parts of Europe, and a good market yet remains to be developed. The touring car has found a good sale, especially the lighter one. The country in general is mountainous and light cars with strong power meet with favor. Most of the roads are good, and the motor can be used in any place where wagons can go.

Method of Handling Trade

The American motor car is well introduced here. It is claimed that of 600 cars sold in Sicily 200 are of one American make. Another American company has had an agency here for a year and a half and has sold seven cars. The first-named sells for \$820, the last for \$1,545. The cause of these high prices lies in the fact that after the cars reach Europe they pass through the hands of three agents and each must make a commission. One company has a general European agent in Paris, an Italian agent in Turin, and a local agent in Palermo. The local agents receives \$67.55 per car. It would seem a bad method of exploiting the business. A car which sells for \$500 in America ought to be sold here for \$700 and still give the agent a good profit.

Instead of appointing general agents for a whole country, it would be advisable to sell direct to local agents, giving them such territory as they can well handle and no more. The delay caused by ordering through other than local agents is sometimes detrimental to the business. Another serious objection foreigners have to buying American cars is the failure of the manufacturer to provide all local agents with a sufficient supply of parts. If a part breaks, and a man has to wait for it to be sent from New York, his car remains out of commission for several weeks; therefore, it is important that a complete supply of parts should be in the hands of each agent.

Market for Cheap Cars

The Italian and French makers hold the market here for high-priced cars, but, as before stated, the low-priced American car is in favor, and there is still opportunity for other manufacturers to get into the market. One dealer here would like to receive quotations for cars costing from \$500 to \$800. Four-cylinder motors, with right-hand drive, are preferred. The steep grades demand powerful motors and strong brakes. Self-starting devices are in favor. Only a direct agency will be considered.

The truck and light delivery cars are very little in use here. Palermo not being an industrial center, the use of the heavy truck is limited. There are no large department stores in this city, and the smaller stores do not, as a rule, deliver their goods. Consequently, there is not a large market for light delivery cars; but, as the city is growing, and houses are being built farther from the business centers, the necessity for delivery will grow, and a fair business in delivery cars might be developed.

SPRAYING MOLTEN METAL

Many are cognizant of a process of plating metals with a thin layer of another metal for the purpose either of resisting rust or of taking a high polish. Plating up to very recently has been accomplished by an electro depositing process or by rolling on the baser metals thin plates of the superior metals.

Now R. K. Morcom, an Englishman, has described a newer process to the Institute of Metals. This consists, briefly, of a large size automatic piston, which, by means of a feed mechanism, melts and sprays the metal on to whatever it is desired to coat. Although an intensely hot flame is employed to melt the metal as it is fed, yet it is possible, owing to the temperature at which it strikes the surface to be coated, to plate or deposit on wood, fabrics, celluloid, and even explosives with equal safety.

So far as motor parts are concerned, it will doubtless be used, if it is not already in use, in one or two progressive factories for coating the whole of the chassis with some non-rusting metal. Parts which have been subjected to sand-blasting are best for causing the metal to adhere well, and, naturally, as in electro plating, the surfaces must be chemically clean. There are other uses for this ingenious invention which are of interest to motor manufacturers, viz., it can be employed for fine castings; an ordinary pattern, if slightly greased, can be sprayed over and most minutely copied. It can also be used for lining the sand or other moulds used in casting, with the result that, owing to the fine polish produced on the mould, a cleaner casting is produced.

To explain in detail the whole of the process, as it was described by Mr. Morcom to the Institute of Metals, would possibly weary our non-technical readers; it is sufficient to say that the process is somewhat akin to shooting a stream of molten metal at the article to be coated, the pistol being held in the operator's hand while he directs its movement to enable the surface to be evenly coated. Very large articles require some form of mechanical traverse to hold the gun when it reaches dimension which render it too heavy to be handled by manual means.

TWO CARRIAGE MEN TO CHANGE VOCATION

Two well known names in the wagon trade are to be identified hereafter with the textile industry, according to plans of the promoters of the Kentucky Cotton Yard Co. W. C. Nones, former president of the Kentucky Wagon Mfg. Co., has been made president of the Kentucky Cotton Yard Co., and S. M. Nones, formerly manager of the wagon company, is secretary and treasurer of the wagon company. R. F. Phillips, formerly with the Louisville Cotton Mills Co., is to be manager. The incorporation papers are to be filed shortly and will provide a capital of \$50,000. The company at first will lease and equip an existing building and operate in it.

WALNUT STAIN

An excellent stain to represent walnut is made by applying hot the following mixture: Five ounces dry Vandyke brown, three ounces washing soda, and half an ounce of bichromate of potash. Another stain for the same purpose may be made by mixing $\frac{1}{4}$ lb. dry burnt umber with one quart of hot vinegar.

Convention of National Federation of Implement and Vehicle Dealers

At the Hotel Sherman, in Chicago, on October 13, 14 and 15, was held the fifteenth annual convention of the National Federation of Implement and Vehicle Dealers' Associations. The gathering was the largest ever held by the association, both in number of associations represented and delegates present.

The far west was represented at this meeting for the first time, the Pacific Northwest Implement and Hardware Association sending its secretary, E. E. Lucas, and the Montana association its secretary, F. T. Betzner, as delegates.

Beside the regular sessions of the Federation there was an important conference with the sales managers' department of the National Implement and Vehicle Association for a discussion of a number of topics presented by both the sales managers' department and the Federation.

President Sebenthall called the first session to order at 10 a. m., October 13. After the reading of the minutes of the last convention by Secretary Hodge, the president appointed the following committees:

Resolutions—T. G. Wiles, chairman; E. P. Armknecht, W. C. Mangold, C. M. Johnson and E. C. Barton.

Programs for Association Conventions—C. I. Buxton, W. L. Derry and E. G. Busch.

Nominations—T. J. Turley, W. M. Vickery and M. D. Thompson.

Auditing—R. A. Lathrop, E. W. Robbins and F. L. Warrington.

President Sebenthall addressed the convention briefly. He spoke earnestly and with much feeling of the responsibilities and opportunities of the retail implement dealer in connection with the extraordinary conditions created by the war in Europe.

In Secretary Hodge's annual report he had this to say in reference to the vehicle warranty and conditions in that branch of the industry represented in the association:

Vehicle Warranty—You will remember that this Federation went upon record at its last meeting as being opposed to the proposed action of the Carriage Builders' National Association pertaining to the vehicle warranty, advance information concerning same having come to our attention. You will recall that several telegrams passed at that time, both organizations being in session the same week. I now have to report to you that in February of this year I received a letter from Secretary McLear of the C. B. N. A., giving notice that the executive committee of that association had voted to appoint a committee of their number to confer with this Federation upon any matters which may arise that would be of mutual benefit to the two associations. This committee was appointed and I am advised by the chairman that he will be in attendance at the convention, and I take it, will be prepared to discuss this important question with us. Any vehicle warranty that is not as broad in its scope as that given by the mail order houses is a handicap to the dealer.

Vehicle Trade—There is considerable apathy apparent on the part of the retail dealers in regard to the vehicle trade. A report to the Carriage Builders' National Association at its recent convention shows that there were over 1,200,000 vehicles built in 1913. Not a very great reduction in the total output of the factories, but there has been a very material falling off in the number of vehicles sold by the retail dealers. They have been less aggressive than formerly and have allowed themselves to be frightened into the belief that the automobile had supplanted the horse-drawn vehicle entirely. The consequence is the mail order houses and trailers are getting the business. I think this Federation should adopt a resolution on this subject. It is important and such a resolution might be a stimulant to some dealers.

A communication received from the sales managers' department of the manufacturers' association contained a list of topics

to be submitted for discussion at the annual conference with the Federation. The convention discussed the propositions and selected representatives to present the Federation's views at the conference. The convention also prepared a list of topics to be presented to the conference and selected the speakers to handle them.

The secretary read a communication from H. B. Staver, representing a special committee of the Carriage Builders' National Association, stating that if the Federation desired, he would appear before it to confer on matters of mutual interest, including the vehicle warranty. Secretary Hodge was instructed to invite Mr. Staver to attend one of the sessions.

The delegates then repaired to the Congress Hotel for the conference with the representatives of the manufacturers' association.

Hold an Interesting Conference

There was an unusually large attendance at the conference. Beside the representatives of the sales managers' department of the National Implement and Vehicle Association the manufacturers were represented by credit men, advertising men and executives. After the usual preliminaries the conference took up for consideration the topics that had been suggested by the two bodies and the various questions were discussed by representatives of both bodies at great length.

Standardization

The subject of standardization was on the docket of both the Federation and the sales managers' department. Members of the latter body stated that manufacturers had reached the point where they must reduce the sizes and kinds of machines, wagons, etc. If this is not done they will be compelled to advance prices. They asserted that the question is one of equal importance to dealers and manufacturers, but that it would be practically impossible for the manufacturers to accomplish very much in the direction of standardization without the co-operation and support of the dealers.

Astonishing figures on the number of different styles of machines used for the same purpose and the combinations of wagons that can be made from the many different sizes of wheels, skins, axles and other parts were presented. It was declared that the variety of certain implements could be reduced 85 per cent. without interfering in the least with farming operations, and it was said three-fourths of the wagon combinations could safely be eliminated.

The manufacturers' representatives asked the Federation to appoint a committee to act with the manufacturers' association in an effort to advance the standardization movement. In response, representatives of the Federation pledged the support of that body and of its constituent associations in the effort to eliminate superfluous sizes and styles to the extent it could be accomplished without retarding improvements.

Assistance for Club Extension

Secretary McCullough announced that the National Implement and Vehicle Association would continue to give financial assistance in the extension of local clubs. The manufacturers realize the importance of continuing this work. He said that a suggestion has been offered by association secretaries to the effect that it would be advisable to alter the plan adopted two years ago, so that the money contributed by the association for local club work would be paid to the different state and interstate associations instead of to the local clubs. He said

the sales managers' department had this proposition under consideration and thus far it seemed to be favored.

The Federation again asked the consideration of the sales managers' department of its suggestion, made a year ago, involving the overcrowding of territory in the sale of machines. Many instances were given showing the evil results of placing agencies too closely together. The sales managers' department pledged its consideration of this matter.

The dealers presented a kindred subject asking that the manufacturers, when withdrawing the agency of their line from a dealer, relieve him of any of their goods that he may have on hand that are in a salable condition. The sales managers' department also promised consideration of this proposition.

SECOND DAY'S SESSION

The Federation at its second day's session took up for consideration the topics discussed at the conference the day before and the requests that had been made by the sales managers' department.

A committee on standardization was appointed to co-operate with the manufacturers in determining types and sizes of machines and wagons best adapted to different territories. This committee is composed of the secretaries of the state and interstate associations embraced in the Federation.

In discussing local club extension the statement of the Federation delegates appeared to be in favor of payment to the state and interstate associations, rather than to local clubs, of any money that the manufacturers' association is disposed to contribute to further the local club movement. In fact, this was moved and carried.

The property statement submitted at the conference was taken up for consideration and discussed at length. Opposition to approving the form unless amended developed. The first clause of the property statement reads as follows:

"For the purpose of obtaining credit now and hereafter for goods purchased, I, or we, herewith submit to you the following statement of my, or our, resources and liabilities, and will immediately notify you of any material unfavorable change in my, or our, financial condition."

A motion was adopted that the form be approved provided all of the words in the above clause following the word "liabilities" be stricken out, and that the following question be added: "Do you belong to any implement dealers' association or local club?"

A motion was also made recommending to the sales managers' department that another question be added, namely, "Do you subscribe for a trade paper?" In explaining this motion, the delegate stated that he considered the reading of a good trade paper, as well as membership in an association, a strong point in favor of a dealer seeking credit. The motion recommending this question to the sales managers' department was carried.

The report of the treasurer was read and referred to the auditing committee.

At the afternoon session the convention took up for consideration the recommendations made in the secretary's report.

The committee on resolutions was instructed to place the Federation on record as heartily in favor of agricultural extension by means of country demonstrators or farm advisers. It was stated that some complaint has been received relative to the attitude of certain farm demonstrators who had been attempting to promote co-operative and mail order buying among the farmers with whom they came in contact. The opinion was expressed that dealers should be on their guard to prevent this as far as possible.

Conference on Vehicle Warranty

Harry B. Staver, representing the Carriage Builders' National Association, appeared before the Federation to explain the attitude of the executive committee of that organization on the subject of vehicle warranties. Mr. Staver is chairman of a special committee that was appointed by the executive com-

mittee last winter to confer with the dealers' Federation on matters of mutual interest, including the warranty.

It was explained that the Carriage Builders' National Association in 1906 had adopted a resolution favoring the withdrawal of vehicle warranties as soon as possible. This, however, had not bound manufacturers to withdraw the warranty, and few, if any, had done so. The subject was brought up again a year ago at the 1913 convention of the C. B. N. A. and telegrams had passed between that body and the Federation, the latter asking for the appointment of a committee to meet a committee of the Federation and arrange for an equitable warranty. The appointment of the committee of which Mr. Staver is chairman was in response to that request of the Federation.

Mr. Staver stated he was sure that the Carriage Builders' National Association is disposed to give careful consideration to the views of the dealers and will take no action unfair to them.

A motion was made and carried that the president appoint a committee of three to confer with Mr. Staver's committee prior to the annual meeting of the executive committee of the C. B. N. A., to be held November 13. This committee was authorized also to discuss with the vehicle manufacturers' committee any other questions of mutual interest. The president appointed P. T. Rathbun, of Ohio, E. P. Armknecht, of Iowa, and T. G. Wiles, of Kansas.

Better Buying

C. M. Johnson brought up the question of "Better Buying." He expressed the opinion that it was incumbent upon the Federation to make an investigation to determine whether or not some plan can be adopted by which the 15,000 dealers represented by the Federation will be enabled to get better prices than are now available to them on some of the smaller articles in their line, outside of trade-marked goods. Mr. Johnson's remarks on the subject were approved by several other delegates and his motion that a committee of three be appointed to investigate the proposition and if possible devise some plan for obtaining better prices on goods of the character mentioned, and report at the next convention, was passed. The president appointed C. M. Johnson, Minnesota; E. W. Robbins, Wisconsin, and Ed. Lehmkuhl, Nebraska.

THIRD DAY'S SESSION

Business of the final day's session was begun with the report of the auditing committee, which showed that the accounts of the treasurer had been carefully audited and found correct and that the expenditures of the past year had been approximately the same as the receipts, leaving a balance on hand of \$1,019, as compared with \$1,028, the balance reported a year ago.

T. G. Wiles, chairman, submitted the report of the committee on resolutions, which was adopted.

The convention instructed the secretary to prepare and send to the secretaries of the constituent associations a letter giving in a concise form the various achievements of the Federation since it was organized that have been for the benefit of the retail implement and vehicle trade. The object of this action is to enable the secretaries to extend their association and local club work.

Election of Officers

The following officers were elected for the coming year:

President—F. R. Sebenthall, Eau Claire, Wis.

Vice-president—P. T. Rathbun, Springfield, O.

Directors—T. G. Wiles, Cherokee, Kas., and W. L. Derry, Vermont, Ill.

WILL QUIT BUSINESS

The Wheeler Carriage Co., which for some years has been one of the leading manufactories in its line in Louisville, is dissolving and going out of business, according to the decision of the stockholders, reached at a recent date.



PRESIDENT WRENN'S DINNER TO THE EXECUTIVE COMMITTEE AND HIS GUESTS

C. B. N. A. CONVENTION DATES

Meeting of Executive Committee in New York, and President Wrenn's Dinner

At the executive committee meeting of the C. B. N. A., held at the Hotel Astor in New York City, on Friday November 13, the dates for the 1915 convention were set for the week of September 20, at Cleveland, O., with the Hollenden Hotel as headquarters.

The committee decided that there shall be no liquors served hereafter at the annual banquets.

Other matters of importance to the trade were considered and will be made public later.

In the evening, President Wrenn gave an inaugural dinner to the members of the C. B. N. A. executive committee and his personal guests.

Those present, beginning with the host, to the left and around the table, are as follows: President C. O. Wrenn, Chas. E. Adams, Chas. A. Lancaster, W. H. McCurdy, C. H. E. Redding, A. M. Ware, H. B. Staver, W. A. Sayres, Theodore Luth, P. E. Ebrenz, W. H. Roninger, W. E. Maxwell, Homer McDaniels, G. W. Huston, T. M. Sechler, Henry C. McLearn, J. D. Dort, O. B. Bannister and Lewis Straus.

TRADE CHANCES IN SOUTH AMERICA

Business Trips to South America

Visits of American commercial delegations to Brazil afford an opportunity for the embassy earnestly to call attention to the importance of American firms being directly represented in Brazil—or at least in Rio de Janeiro—by Americans enjoying full powers to represent their principals. Correspondence on file with both the consulate general and the embassy show that American exporters in many instances are seriously handicapped by the lack of such agencies.

With few exceptions, American exporters are now represented in this capital either by Brazilian firms, by English firms, or by American technical experts who, while thoroughly capable of judging local conditions, do not enjoy sufficiently ample authorization from their principals to act in an emergency without telegraphic instructions. It is a well established fact that many of the British or Brazilian houses now acting in this capacity for American manufacturers, while undoubtedly exerting their best efforts on behalf of their principals, are hampered by the fact that they often represent more than one foreign exporter whose interests are—or may be—conflicting.

Local conditions are peculiar. As in many other countries, politics and business are inextricably mingled. Strong pressure may be brought to bear from unexpected sources and an intimate and impartial knowledge of all local conditions is, therefore, vital. Living expenses are very high and to a certain

extent the wage scale is correspondingly so, and any American exporter who might contemplate compliance with the suggestions contained in this dispatch should be prepared to assume a relatively large initial expense from which there would probably at first be no return. The experience of the comparatively few American houses who are directly represented here has appeared to justify the expenditures to which they have been put, if not in immediate business returns, yet certainly in an intimate knowledge of local conditions of inestimable value for the future.

Rio Negro Valley of Argentina

Bahia Blanca is rapidly becoming the commercial capital and chief center of much of the southern portion of Argentina, as well as the most accessible port in the country for foreign shipping. It is the outlet particularly of the valleys of the Rio Colorado and the Rio Negro.

The natural distributing point for all this region at present is Bahia Blanca, and it will probably continue to be so indefinitely, notwithstanding the contemplated extension of the Southern Railway to Chile from Zapala, where the line now terminates.

The direct trade of the United States or Europe with the consumer is not great. The few large foreign houses have various credit arrangements with their customers. In general four months' credit is allowed or 5 per cent. for one month, payments being made by draft on the crediting country.

Representatives of American firms who come to Buenos Aires might do well to continue to Bahia Blanca; but their efforts will probably prove far less useful there than in the cosmopolitan capital of the republic unless they speak the Spanish language fluently and correctly and their acquaintance with the Latin-American and his customs and characteristics is considerable. Otherwise they would be at a great disadvantage where other foreign agents, particularly the Germans, fit as well into the local customs and language as the natives themselves. There is a distinct prejudice in favor of all classes of American machinery, but this will continue to be largely offset so long as American firms send representatives who, though well acquainted with the technical side of their various lines, are wholly unacquainted with local customs and language.

Hindrances to Trade Extension in Colombia

Pilfering en route, invited by the careless or inadequate packing of goods shipped to Colombia by American firms, forms one of the chief causes of complaint among local merchants when trade connections with the United States are suggested.

Business Outlook in Chile

Business in general in Chile continues rather slow, and the outlook for improving conditions before the end of 1914 does not seem overly encouraging. For the first four months of 1914 there was a decided falling off in the collection of import duties in the several ports.

Notwithstanding the condition of business it would seem that this is a fairly good time for American interests to investigate the field and get ready to take advantage of the increased business that is bound to follow the depression now prevailing over Chile. The natural resources of the country are very great, and better times will bring a wonderful development, both in the agricultural and mineral fields.

Traveling men now visiting Chile do not succeed in getting large orders or doing what might be called a paying business, but they report that they are well satisfied with the results since they are able to get in closer touch with importers and retailers than they could do even when business was moving normally. Purchasers are able to go over matters very much more thoroughly now and decide what the trade will demand when the volume of business increases.

It should be understood that this propagand work, while

not profitable at the time, will in the end be most profitable to the manufacturer or exporter who is really earnestly pushing for the business in South America. This work is the foundation of the business structure and can not be omitted without a serious loss later on. Too often salesmen are sent out for a five or six months' tour of South America to see what can be done by way of taking orders. These men go out and make a record for that particular trip and too often misrepresent the goods they have for sale, so that when the goods arrive the purchaser is dissatisfied. This practice hurts and should be avoided. The salesman who makes the first trip should be given ample time to investigate the field thoroughly and to select the best agents obtainable and should be content with smaller orders at first, waiting until later to build.

The imports of this country amount to about \$125,000,000 United States gold a year, of which fully 85 per cent. are manufactured articles. This proportion is destined to increase materially, as it has in late years, and now is the time for American interests to make a strong effort to obtain their share of this trade.

IMPORTED DRAFT HORSES NO LONGER NECESSARY

With the exception of a very limited number from England, importation into the United States of pure bred draft horses for breeding purposes has been practically stopped by the outbreak of the European war. For several years previous, from 2,500 to 4,000 stallions and mares have been brought annually into this country. In the opinion of experts in the United States Department of Agriculture, however, the standard of draft horses in America will not suffer from the interruption of these importations. There is, it is said, a sufficiently large amount of pure blood already in the country to answer all requirements and the American draft horse will now have an opportunity to demonstrate his own qualities. Hitherto a certain fascination has hung over the word "imported" which has had a marked effect upon prices. For example an imported Percheron stallion might sell for \$2,000, where an equally well bred American Percheron would bring only \$1,200 to \$1,500.

THE GUARANTEE OF QUALITY

Largely equivalent to proved quality as a buying impulse is guaranteed quality. The purchaser of a mechanical device gave the following reason for his decision: "I bought my machine because it was guaranteed, not for six months or a year, but permanently. The sellers evidently had put so much stability into it that they were willing to stand back of it for any length of time. Of course, I paid more than I might have paid elsewhere, but this I was very willing to do in return for such assurances as I received."

Such a guarantee is not possible for some classes of products, but it illustrates the ideal condition of manufacture and selling. The greater the degree of confidence the seller has in his goods the larger his sales are apt to be and the less effort and expense required to make them.

UNDERTAKERS ORGANIZE AUTOMOBILE CO.

Articles of incorporation of the Falls City Auto Co., with a capital stock of \$6,000 divided into 60 shares of the par value of \$100 have been filed in Louisville, Ky. The organization is composed of a majority of the leading undertakers of Louisville, the incorporators being E. C. Pearson, who is named as president; S. J. McElliott, vice-president; John Schildt, secretary; Henry Rosse, treasurer, and Lee E. Cralle, who, with the other four constitute the board of directors. The corporation is authorized to incur an indebtedness not to exceed 50 per cent. of the paid up capital stock. Other undertakers of the city are named in the articles as stockholders.

National Implement and Vehicle Association Holds Twenty-first Annual Convention

The twenty-first annual convention of the National Implement and Vehicle Association was called to order at Congress Hotel, Chicago, on October 21, and continued in session for three days.

The preliminary session was in charge of the Association Auxiliary, and Louis M. Henoch, president of that body, called the assembly to order. He extended a warm welcome to the manufacturers present, and a fitting response was made by F. E. Meyers for the association, after which the meeting was turned over to President J. A. Craig, who read the president's annual address.

Committees Announced

President Craig announced the following committees to serve the convention:

Resolutions—W. H. Stackhouse, Springfield, O., chairman; H. N. Wade, Batavia, Ill.; A. J. Brosseau, Albion, Mich.; H. M. Kinney, Winona, Minn.; W. E. Taylor, La Porte, Ind.; W. S. Thomas, Springfield, O., and Fred H. Bateman, Grenloch, N. J.
Necrology—C. H. Bagby, Quincy, Ill.; A. Hirshheimer, La Crosse, Wis.; T. M. Sechler, Moline, Ill.; William Loudon, Fairfield, Ia., and R. F. Roberts, Randolph, Wis.

The nominating committee was selected by the convention, as follows:

C. F. Huhlein, Louisville, Ky.; James A. Carr, Richmond, Ind.; A. B. McLean, Mansfield, O.; W. D. Graves, Dayton, O., and Richard Carpenter, Lafayette, Ind.

S. E. Swayne, chairman of the executive committee, then submitted the report of that committee.

The report of Treasurer H. N. Wade showed the association to be in a very prosperous condition, with all debts paid and a substantial balance in the treasury. The receipts for the year to October 15 were \$27,551.91, and the expenditures \$26,765.81.

Before reading the reports of the various business committees, President Craig took occasion to thank the members of the executive committee. He said that this committee at all times teemed with activity and had broken all existing records for the number of meetings held. He wanted every member of the association to take up and work for trade revival. In speaking of the flattering showing made by the financial end of the association under adverse circumstances, the president said that it really showed that the members were all boosters and he wanted everyone to boost and boost hard for the organization and for more business.

The report of G. A. Ranney, chairman of the committee on agricultural extensions showed that this committee was a new one, having been organized during the year but had been active and had prepared a book for general distribution on "A Few Facts About Agriculture." The report went into detail about the expected achievements of the committee which contained the names of such well known agricultural experts as Prof. P. G. Holden and Doctor W. E. Taylor.

The report of Secretary and General Manager E. W. McCullough was then read and it was one of the shortest secretary's reports ever presented to the association.

C. E. More, representing the association's attorneys, Buckley, Gray & More, presented the report of legal affairs of the association during the last year. Mr. More did not read his report which had been prepared, but commented on various paragraphs contained therein.

In the discussion of the report of the attorneys, J. A. Carr arose for information about matters relating to the workmen's

compensation laws. He asked Mr. More if it would not relieve the employer if he took affidavit from the parents of children whose age was around the legal limit. Mr. More declared that in his opinion the employer would not be relieved inasmuch as a jury nearly always finds in favor of the injured party. He recommended some record of vital statistics so that the employer might be able to get the date of birth and other information regarding the employe. He said this was the one safeguard against the imposition of employes who told untruths about their age.

F. E. Myers asked that in case of promissory notes endorsed by responsible parties which went to protest how long a time would elapse without bringing suit before the endorsers would be relieved of responsibility. Mr. More said that in case of dated notes suit should be begun at once. In case of notes of demand, when demand for payment is made and not met then the indorsers are liable within six months.

T. M. Sechler asked that in case of children under legal age are employed upon a parent's affidavit that they are above the legal age, if this would not be perjury and the parents could be so punished. Mr. More said that in case of injury the burden of proof is always placed upon the employer and the parents might easily claim that an unintentional mistake as to dates and age might have been made. It would be up to the employer to run down the facts but "Perjury proceedings might be a good bluff," said Mr. More.

Afternoon Session

The afternoon session was called to order at 2 o'clock by President J. A. Craig, who called for the report of the advisory committee, H. M. Kinney, chairman. Mr. Kinney made a verbal report that the advisory committee was one of reference only and had during the year pursued a policy of "watchful waiting." In other words the committee, he said, had watched the active work of the officers and committees. He explained that the committee of which he was chairman was made up of ex-presidents of the association and was a committee whom the organization chose to honor rather than place any burdens upon it. Mr. Kinney recounted some of the work which had been performed and closed with praise for the various working officers and committeemen.

After explaining the report and making it a part of the convention record, President Craig called for the report of the committee on credits and collections prepared by M. R. D. Owings, chairman of the committee, who was not able to attend but had sent as a substitute E. S. Maddock, manager of credits of M. Rumely Co. The report follows:

Report on Credits and Collections

During the year your Committee on Credits and Collections held six meetings and submit the following as a report of its work:

Manufacturers and merchants needing property statements find difficulty in securing them sufficiently complete to be able to fairly fix the amount of a dealer's credit. Part of this difficulty arises because there has been no uniformity of practice on this subject among manufacturers and merchants, and because many dealers think it would be difficult to furnish the information required, and do not realize the value to them in obtaining credit, of a complete property statement. This would be overcome by adopting a uniform property statement setting forth in the simplest form possible questions intended to elicit the information needed to form right judgment on a concern's financial responsibility and uniformly requiring customers desiring credit to supply such statement.

Your committee, therefore, has spent considerable time in working out a property statement of this nature, which it here-with respectfully submits as embracing the best judgment of its several members as to what is needed and obtainable, and while it is realized that with the methods of bookkeeping prevailing in the offices of the average implement dealers there may be some difficulty in getting correct answers to some of these questions, they will be educational to the dealer, and the request coming to him uniformly endorsed by this association, the National Federation of Retail Implement and Vehicle Dealers' Association, and perhaps other associations, will impress him with the necessity for this information, and enable him when once prepared to meet any subsequent request for such information without much additional effort or expense. We believe when understood by the dealers that this information is necessary in order to give them the full measure of consideration in their purchases and that one manufacturer is not asking for information that is not needed by all alike, the dealers' objections to supplying it will be removed, and when the dealer understands that this information will be called for uniformly by the manufacturers or distributors he will be disposed to keep his records in such a way as to readily supply it.

Much assistance can be rendered a dealer by the representatives of the manufacturers, not only in obtaining these statements, but advising him on the best methods of keeping his accounts.

It has been our purpose to have the questions so simple and the need for the information in this property statement so apparent, that we are not taking up any space in this report in the discussion of the details making it. It is expected that the representatives of this association will address the various dealers' conventions throughout the country and explain this statement and its use, soliciting at the same time the co-operation of the dealers in making its adoption universal. We trust our members generally will consider it their duty to co-operate with us to aid in securing the universal use of this blank.

Proposed Plan to Protect Creditors

It is frequently found that through a combination of circumstances involving perhaps over-purchasing, adverse climatic conditions, etc., that some of our customers find themselves in an embarrassed condition at the maturity of their bills, and there seems to be no co-operative methods to relieve them of this embarrassment, if so unfortunate as to overestimate requirements.

The committee in its several meetings has given consideration to this subject, and the proposed plan is the result of its efforts to work out something practical along this line, and the attached plan has been offered with the suggestion that it be submitted to a number of manufacturers, prominent in the field, to determine whether it is considered practicable to secure co-operation in situations of this kind, and if so, their views upon what the committee has worked out.

It is not intended to take away any of the privileges that a distributor now enjoys, but it does suggest steps co-operatively to protect his interests as well as others when he has exhausted resources in following up his individual accounts, thus in many instances conserving the resources of the dealer, giving him the assistance necessary to relieve his embarrassment, and avoiding an action that might precipitate his affairs into bankruptcy and make him prey to an arbitrary action that would not result in any good to any of the creditors and perhaps entail an unwarranted expense upon those who might be disposed to grasp the first offer of assistance to protect their individual interests.

Your committee realizes that this is a comprehensive subject and cannot become operative without entailing some responsibility upon any concerns participating, but it is believed that some plan of this kind would result in great economy of expense and loss in the conduct of our business, and result in the continuance in business of deserving dealers.

It is contemplated that a further report will be made as soon as the conclusions of those to whom the plan has been submitted have been received and considered.

Objection to Property Statement

Secretary McCullough stated that the approval of the uniform property statement form prepared by the committee on credits and collections had been asked from the National Federation of Implement and Vehicle Dealers' Associations and that body had taken exception to one of the obligations of the signer. The opening clause of the uniform property statement reads as follows:

"For the purpose of obtaining credit now and hereafter for goods purchased, I, or we, herewith submit to you the following statement of my, or our, resources and liabilities, and will

immediately notify you of any material unfavorable change in my, or our, financial condition."

The dealers' Federation had expressed a willingness to approve the form if all of the words following the word "liabilities" be stricken out of this clause, and that the following question be added: "Do you belong to any implement dealers' association or local club?"

H. M. Wallis said he thought the position of the Federation with respect to the above clause was well taken. In his opinion few, if any, dealers would sign a statement obligating them to notify their creditors of any material unfavorable change in their financial condition, and he thought it inadvisable to include anything in the statement that would be objectionable. President Craig agreed with Mr. Wallis to the extent of advocating some modification of the obligation.

The subject was disposed of for the present by the passage of a motion, offered by Mr. Swayne, that the objection of the Federation, also its recommendation with reference to an additional question, be referred to the committee on credits and collections with instructions to report its recommendations to the executive committee.

Mr. Burg suggested the establishing of a credit bureau as a part of the association activities, and Secretary McCullough replied that the proposition had been under consideration by the executive committee. He expressed the opinion that the association eventually would establish such a bureau.

Referring to the other recommendations of the committee on credits and collections, involving the adjustment of the estates of bankrupt dealers, the president announced that a referendum of the membership would be obtained during the coming year and asked all of the members carefully to study the committee's report on this subject before expressing an opinion.

The report of the committee on foreign commerce and tariff was then read by Chairman Paul E. Herschel.

The report of the insurance committee was made by A. B. McLean. On account of this report having to do entirely with insurance of members of the association, the paper is omitted.

An interesting report from a manufacturer's standpoint was that of Manufacturer's Costs presented by Geo. R. James. This report was ordered referred to the new executive committee for its consideration.

F. E. Myers, chairman of the committee on membership, gave some statistics about the growth of the organization and its possibilities. He urged members to use their influence to secure at least one new member each from among the 200 concerns which are eligible to membership in the organization.

SECOND DAY'S SESSION

The second day's convention was opened Thursday morning by President J. A. Craig. The report of the committee on workmen's accident compensation was read by G. L. Avery, who supplemented an interesting report with diagrams and some statistics on accidents.

The report of the foreign trade managers' department made by C. A. Patison, recounted the work which is being accomplished by the association in procuring information for the members who are engaging in foreign trade or desired to enter that field.

President Craig introduced Captain C. F. Huhlein, who addressed the association on "The South American Field," in a splendid paper which contained the information which Captain Huhlein had gathered during his recent trip to South America extending over 100 days.

Doctor Hale, representing the United States Department of Commerce, addressed the association briefly in explanation of the work which will be done by the new department of the United States government to investigate and permit commercial interests.

Dealers' Day at Convention

"Dealers' Day" was what the afternoon session of the second day was called, and the entire session was devoted to reports

and addresses in which the dealers of the country have a direct interest. These included the report of the committee on dealers' associations by W. S. Thomas, chairman; an address on dealers' problems by H. J. Hodge, secretary of the National Federation of Implement and Vehicle Dealers' Associations, and the report of the sales managers' department by R. B. Lourie, president.

Co-operative Buying

In addition to his regular report Mr. Thomas related a conversation he had with officials of the rural organization service of the Department of Agriculture after the department had issued its bulletin recommending co-operative buying of farm equipment, seeds, fertilizer, etc. Because there are many co-operative farmers' insurance companies, creameries, cheese factories and grain elevators in successful operation, representatives of the rural organization service believe that co-operation in other directions, even to buying all kinds of farm supplies, is practicable. Mr. Thomas cited the failure of numerous co-operative enterprises and asked for an explanation of the statement made in the co-operative buying bulletin to the effect that farmers are the prey of unscrupulous concerns who sell them inferior goods. The officials admitted that they knew of no instances of this character so far as the trade in implements is concerned. They then attempted to justify their suggestion by saying that the dealers are inefficient. Mr. Thomas told them that there are inefficient business men in all lines and that sooner or later they are forced out of business as the result of their inefficiency. He assured them that the implement trade has no more than other lines and that there has been wonderful improvement in that trade in recent years; largely as the result of association work, and that the improvement is going on all the time. He also said that there are enough efficient dealers to serve the farmers well. The officials then said that the dealers' repair service is inadequate, and Mr. Thomas said millions of dollars are tied up in repair stocks held by manufacturers, dealers and transfer houses. He explained that a dealer might have \$1,000 worth of repairs on hand and still receive an order he could not fill promptly. The same thing happens every day in some of the largest mercantile establishments in the world. Mr. Thomas told the officials that the manufacturers who are producing the bulk of the farm implement output regard the dealer as indispensable. He is a necessary link in the chain of distribution, and the farmers would be seriously handicapped without the service he renders.

President Craig then arose to introduce H. J. Hodge, secretary of the National Federation of Implement and Vehicle Dealers' Associations. Mr. Craig praised the work of Mr. Hodge, who was one of the earliest organizers of the association efforts and one of the boosters of the Western Association, the first of the dealers' associations to be formed. Mr. Hodge delivered a very interesting address on "The Dealer's Problems."

THIRD DAY'S SESSION

There was a splendid attendance at the morning session of the closing day. The session was devoted to the discussion of the reports of various committees.

The afternoon session given over to the reports of the wagon department of the association, the necrology committee and the election of officers.

The report of the nominating committee recommended the election of the following ticket, and the report was adopted by unanimous vote:

President—S. E. Swayne, Robinson & Co., Richmond, Ind.
 Vice-presidents—J. E. Brown, Aultman & Taylor Machinery Co., Mansfield, O.; E. B. Sawyer, Cushman Motor Works, Lincoln, Neb.; M. M. Baker, Holt Mfg. Co., Peoria, Ill.; W. R. Lumry, Associated Mfrs. Co., Waterloo, Ia.; H. L. Whitman, Whitman Agricultural Co., St. Louis, Mo.; C. G. Rowley, Aspinwall Mfg. Co., Jackson, Mich.; F. H. Bateman, Bateman Mfg. Co., Grenloch, N. J.; H. G. Newcomer, Eureka Mower Co.,

Utica, N. Y.; E. K. Emig, Acme Wagon Co., Emigsville, Pa.; W. C. Smith, Vermont Farm Machine Co., Bellows Falls, Vt.; J. S. Baker, Baker Mfg. Co., Evansville, Wis.; B. P. Thornhill, Thornhill Wagon Co., Lynchburg, Va.

Treasurer—H. C. Stahl, Ohio Cultivator Co., Bellevue, O.
 Chairman Executive Committee—A. J. Brosseau, Gale Mfg. Co., Albion, Mich.

Members Executive Committee for Three Years—Paul E. Herschel, R. Herschel Mfg. Co., Peoria, Ill.; F. D. Park, Flint & Walling Mfg. Co., Kendallville, Ind.; Wm. Black, B. F. Avery & Sons, Louisville, Ky.

Acknowledgments were made by Mr. Swayne and Mr. Brosseau, the former taking occasion to pay a warm tribute to the retiring president, J. A. Craig, of whose work for the association he spoke in highest terms.

E. W. McCullough was reappointed secretary and manager of the association.

The next convention will be held at Indianapolis.

MEETING OF AUXILIARY ASSOCIATION

At the annual meeting of the Auxiliary to the National Implement and Vehicle Association, held at the Congress Hotel, Chicago, October 22, the meeting was called to order by President Henschel, a large number of members being present.

The president reviewed briefly the work and progress of the association, and the treasurer read his annual report.

The Auxiliary adopted appropriate resolutions in memory of two deceased members, A. M. Todd and J. M. Pickands.

The following officers were elected: President, E. J. Baker, Farm Implement News, Chicago; first vice-president, Capt. O. H. Morgan, Chicago Varnish Co., Chicago; second vice-president, M. Taylor, Acme White Lead & Color Works, Detroit, Mich.; third vice-president, G. F. Danielson, Youngstown Iron & Steel Co., Youngstown, O.; secretary and treasurer, W. R. Alcorn, Tousey Varnish Co., Chicago; chairman entertainment committee, E. A. De Campi, National Lead Co., Chicago; chairman membership committee, B. E. Hamilton, Illinois Steel Co., Chicago.

HARDWOOD MANUFACTURERS' ASSOCIATION MEETING

The Hardwood Manufacturers' Association will hold its annual meeting at the Hotel Sinton, Cincinnati, January 28-29.

A special invitation is to be extended this year to the consuming manufacturers, and it is expected that there will be a large representation of consumers present. The general condition in the hardwood market, due to the European war, will undoubtedly attract practically all the hardwood mill owners to the meeting.

OBJECT TO INCREASE IN TERMINAL SWITCHING CHARGES

Protests against the increase in switching rates of the Kansas City Terminal Railway Co. and against the elimination of stoppage in traffic proposed by the railroads were made by members of the Kansas City Implement, Vehicle and Hardware Club at the regular monthly meeting at the Hotel Baltimore, November 9.

The changes in the rates of the Terminal company increases the cost of switching from \$2 to \$4 per car and for "trap" switching, such as switching the cars about the yards, which has previously been done free of charge, the Terminal company now has fixed a charge of 4 cents per hundred pounds, an average of \$4 per car.

The elimination of the stoppage in traffic also has been strongly opposed by the club. Formerly manufacturers in shipping from one place to another were able to pay an additional

sum of \$5 and distribute their goods at different places. The railroads favor doing away with this system entirely.

The protests will be filed with the traffic bureau of the Commercial Club, and later with the Interstate Commerce Commission.

An election of officers of the club resulted as follows: Horace Carr, Jr., president; Lewis C. Yount, first vice-president; Simor C. Robertson, second vice-president, and George F. Massey, secretary and treasurer. J. Howard Harbison was elected chairman of the executive committee.

INSTANTANEOUS GLUE DISSOLVER

Patents have been applied for on a device for quickly dissolving glue without contact with steam, and for retaining the liquid in condition for immediate use. A sheet metal cabinet of circular form is provided, adapted for connection with a low pressure steam supply. A copper pan with a brass wire sieve

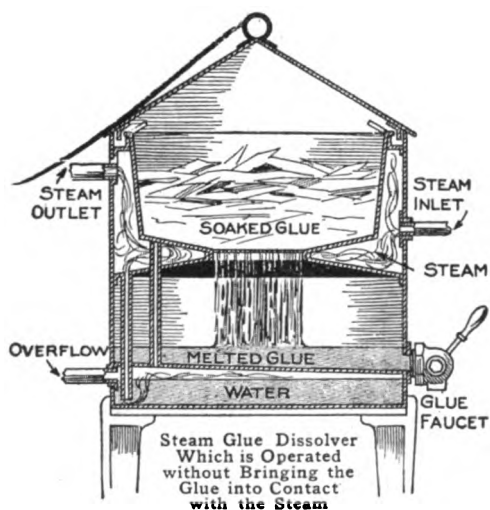

at the bottom, fits over a copper retaining vessel, having a faucet at the lower edge. Soaked flake glue is put into the removable pan and the cover replaced. Immediately upon turning on the steam, which circulates about all sides of the dissolving pan, the glue commences to dissolve, dripping through the fine wire mesh into the retainer beneath, where it is kept liquid by the heat from the steam.

ELECTRIC DOOR OPENERS

Electric door latches, eliminating entirely door handles of any form is a feature of the new Scripps-Booth car to succeed the cyclecar which this concern brought out a year ago. A push button, placed close to the door in the side of the body, operates the latch magnetically.

It is in connection with the bodies that the luxury of the Scripps-Booth appears. It is made in three body styles, namely, roadster, cabriolet, and coupe, all with three passenger capacity. The roadster sells at \$775. This body has come under the hands of a clever designer for it is exceedingly attractive. It is a streamline type with a decided slope to the bonnet. The effect is carried out by a V-shaped radiator of German silver and by continuing the bonnet slope back to the end of the cowl. The rear is given the torpedo shape, and this is attractively set off by the mounting of a spare wheel on the deck.

Seating is well worked out. The drive seat is placed slightly forward of the passenger seat which gives a modified staggered arrangement, and ahead of this there is mounted an auxiliary folding seat to accommodate a third person. Deep Turkish upholstery of long-grain buffed leather, unusual in a car of this type and price, and having a depth of 9 inches, is used.

Domed fenders do their part in making the machine attrac-

tive, and with wide doors and clear running boards the body meets every requirement of the most fastidious. The door width, to be exact, is 21 inches.

The drive is on the left, a 16-inch walnut steering wheel being used. On this there is a throttle lever swinging vertically, and an unusually large push button operates the Klaxet horn. This is a domed aluminum affair placed at the center of the steering wheel spider and having a 3-inch diameter to make horn signaling as easy as possible.

PERSONAL

Gus C. Nuetzel, president of the Ruby Carriage Co., Louisville, Ky., who was threatened with the loss of his eye on account of injury suffered when a chip of steel struck him, is recovering and is able to spend some time daily at the shop.

A. W. Grafton, Iowa manager for the MacKinnon Wagon Co., announces that he has been made Iowa manager also for the F. A. Ames Co., of Owensboro, Ky., which has opened a selling campaign in the state for the Ames and Liberty buggies. R. L. Axton, of Kentucky, is in the north half of the state, and L. C. Goring, Jr., of South Carolina, in the south half. Both are under the direction of Mr. Grafton. Samples are being shown on the display floors of the Hawkeye Transfer Co., in Des Moines.

OLD BUGGY CONCERN CLOSES

The Hynes Buggy Co., one of the oldest business establishments in Quincy, Ill., closed its doors October 31 never to reopen. This concern has been commercially active for nearly 50 years. The Hynes Buggy Co. was established in 1869 and gradually came to the front until it was incorporated in 1892. The chief business of the concern was done in Oklahoma, Texas and other parts of the growing southwest. When the automobile business began to thrive a number of years ago indications of the end now at hand began to appear. H. J. F. Ricker is president of the concern, B. Aberkamp is secretary and treasurer, and H. H. Bartelt is manager. Manager Bartelt will remain on the job for six weeks or two months settling up the accounts and closing the business.

DIRECTION OF THE NAP

It is usually asserted by the trimmer that the various parts of the trimming should be so made up that they brush to the front, the main argument being that it is easier to clean an interior made up in this way. An interesting deviation from this way of looking at the question was heard, where an experienced workman held just the opposite opinion. He pointed out that he preferred to have a head lining with the nap running from the front to the back, as by this means less dust was taken up by the cloth, as the draught flowing into the body was in the direction of the nap of the cloth and not against it.

THE BIG AUTO SHOWS

From the number of exhibitors who have been allotted space for the Fifteenth Annual National Automobile Shows to be held in New York and Chicago, it is evident that manufacturers of automobiles, motorcycles and accessories are preparing for the greatest year of business in the history of the industry. The New York show is to be held in the Grand Central Palace, January 2-9, and the Chicago show will be held in the Coliseum and First Regiment Armory from January 23 to 30.

The Cook Carriage Co., of Bloomville, O., is seeking to locate in Tiffin, O. The Chamber of Commerce of that city is looking after the proposition, and it is believed that arrangements can be completed for the removal of the plant.

TRI-STATE CONVENTION AT CINCINNATI

The sixteenth annual convention of the Tri-State Vehicle and Implement Dealers' Association was held in Music Hall, Cincinnati, O., October 20-22. The attendance was good and a splendid meeting was enjoyed by all the members of the association. An exhibit was held during the week of October 19-24, in connection with the convention, which was well patronized and attracted many dealers from nearby states. Following is a brief account of the proceedings of the convention:

The first session was called to order at 4 o'clock Tuesday afternoon, October 20, by President T. H. McGeorge. After declaring the convention opened, President McGeorge called for the reading of the minutes of the last meeting by the secretary, P. T. Rathbun. Then followed the address of President McGeorge, which filled the dual purpose of welcoming the dealers and reviewing the work of the association with prospects for the future.

The report of the treasurer showed substantial increase of membership during the past year and a balance on hand October 1 of \$3,252.52. The report was referred to the auditing committee.

President McGeorge announced the following committees:

Committee on Resolutions—T. J. Turley, Owensboro, Ky.; W. G. McMaken, Ft. Wayne, Ind.; D. H. Steiner, Sterling, O.

Auditing Committee—W. J. Bulleit, Corydon, Ind.; H. A. Lowry, Litchfield, Ky.; Jno. Schultz, Worcester, O.

Committee of Chronology—Geo. P. Wagner, Jasepr, Ind.; O. S. Torbet, Columbia City, Ind.; T. L. McCarty, Ft. Branch, Ind.

At this point President McGeorge introduced J. F. Follmer, secretary of the Michigan Implement and Vehicle Dealers' Association, who had prepared a talk on Business Costs.

At the close of the address the convention adjourned until Wednesday afternoon at 4 o'clock.

The second session was called to order by Vice-President T. L. McCarty, who was called upon to preside over the meeting in the absence of President McGeorge. He introduced Ed. S. Ralph, advertising manager of the American Seeding Machine Co., Springfield, O., who spoke to the members on advertising.

The recommendation made by Mr. Ralph relative to the standardization of catalogs and folders was referred to the committee on resolutions. Action so referring the recommendation was made by a rising vote.

Vice-president McCarty at this point introduced O. S. Torbet, of Columbia City, Ind., who made a talk to the members on the subject of the Application of Costs. This was in the line of a chalk talk and was one of the features of the convention.

At the close of Mr. Torbet's address, the convention adjourned until Thursday morning at 10 o'clock.

The final session of the convention was called to order at 10 o'clock Thursday morning by President T. H. McGeorge.

The auditing committee reported that it had examined the books of the treasurer and found the balance to be \$3,252.52. The report was received and filed.

The report of the committee on necrology revealed the fact that only one member had been removed by death during the year. W. H. Allibrand, of Nicholasville, Ky. Mr. Allibrand was a former treasurer of the Tri-State Association and the committee on necrology presented a short testimony of sympathy to be spread on the minutes of the meeting. At this point the report of the resolutions committee was offered.

Then followed the report of the delegates to the National Federation, presented by T. J. Turley and W. G. McMaken.

The following nominations for officers for the ensuing year were then made: T. J. Turley placed in nomination for president, H. C. Otterbacher, of Wellington, O.

Nominations were closed and Mr. Otterbacher was elected president by unanimous vote.

The convention then divided into groups by states and pro-

ceeded to the election of the following officers, as is the custom of the Tri-State Association.

New Officers**Ohio**

Director for two years—E. H. Huffman, Columbus.

Director for one year to fill the unexpired term of President-elect Otterbacher—Joseph H. Goldcamp, Lancaster.

Vice-president—W. H. Carnahan, Blanchester.

Delegate to the National Federation—H. C. Otterbacher, Wellington. Alternate—Joseph H. Goldcamp, Lancaster.

Indiana

Vice-president—T. L. McCarty, Fort Branch.

Director for two years—T. H. McGeorge, Ft. Covington.

Delegate to the National Federation—W. G. McMaken, Ft. Wayne. Alternate—W. J. Bulleit, Corydon.

Kentucky

Vice-president—H. A. Lowry, Litchfield.

Director—C. S. Darnaby, Lexington.

Delegate to National Federation—T. J. Turley, Owensboro. Alternate—W. C. Dorman, Corinth.

Mr. Otterbacher offered his resignation as director of the association, which was accepted, and the convention adjourned to meet at the call of the board of directors.

A smoker and better acquaintance meeting was held at the Hotel Gibson, Wednesday evening. The meeting was called to order by President T. H. McGeorge, who announced that the meeting was called for the purpose of getting better acquainted. He said that "All work and no play makes Jack a dull boy," but, "That too much play is as bad as too much work," so an effort was to be made to mix the two together.

The first speaker to be introduced was R. C. Craig, of Indianapolis, Ind., who spoke upon "The Local Club from the Manufacturers' Viewpoint—How and Why to Organize Results in Our Territory." This was a talk in favor of local clubs as assisting the manufacturers.

Secretary P. T. Rathbun spoke upon the organization of local clubs, and especially to those which have been formed within the territorial limits of the Tri-State Vehicle and Implement Dealers' Association.

At the close of the talk on local clubs and things which are incidental to them, the business program of the evening was declared closed, after which a social session occupied the attention of the visitors. There was music, also short talks by Messrs. Daddlach, Bannister, and Clemons.

BENEFIT OF ROADS TO NONABUTTING PROPERTY OWNERS

The road building specialists of the Department of Agriculture, in Bulletin No. 136, entitled "Highway Bonds," have the following to say about the benefit of a well constructed highway to property owners whose property is not directly on the road to be improved:

In planning the highway system or the main market roads, it will be found necessary to omit many roads the improvement of which is greatly desired by abutting land owners. The fact that such property holders must pay a tax for the bond issue is only an apparent injustice, for if the highway system is well planned the entire county will feel the benefits of the improvement. As a rule, main market roads reach the majority of producing areas, and when they are improved all land values tend to increase.

The fact that cities and larger towns are frequently taxed for bond issues to build highways outside of their own limits is sometimes made a point of debate in bond elections. It is argued that because a large part of the county wealth is within the corporate limits of such cities and towns, highway bond money should also be used to construct their streets. It is even urged that the expenditure should be made proportionate to the assessed valuation within the city limits. If the proceeds

of highway bond issues were distributed in this way, their purpose in many cases would be defeated. The primary object of the county highway bond issue is to build county market roads and not to improve city streets, although a high percentage of the assessed valuation may be city property. It is now known that the expenditure of city taxes on country roads is a sound principle and that it is one of the best features of state aid for highways. In Massachusetts the city of Boston pays possibly 40 per cent. of the total state highway fund, but not a mile of state-aid highway has been built within its limits. New York City also pays about 60 per cent. of the cost of the state highway bonds. Some state laws prohibit the expenditure of proceeds of state highway bonds within corporate limits of cities or towns.

The improvement of market roads results in improved marketing conditions which benefit the city. Most cities are essentially dependent upon the surrounding country for their prosperity and development. The development of suburban property for residence purposes is also dependent upon highway conditions and it is becoming evident yearly that whatever makes for an increase in rural population must be encouraged. Since the introduction of motor traffic, country highways are used to an increasing extent by city residents. In fact, the cost of maintaining many country highways has been greatly increased by the presence of city-owned motor vehicles. The general advance in facilities for doing country business from town headquarters when roads are improved is no inconsiderable factor in the commercial life of the community.

FRANCE SPENDS DOLLAR A HEAD FOR ROAD UPKEEP

While the appropriation for roads in New York state is generally considered a heavy one, it is really small as compared with the sum the French republic spends annually on road maintenance alone. New York appropriations are for the construction of roads, with little or no provision for maintenance, while to the annual expenditures of \$45,000,000 for maintenance, the French authorities add some \$850,000 for the construction of new roadways. M. Jean de Puligny, chief engineer of roads and bridges in France, in an address at the recent Roads Convention of the American Automobile Association, in Washington, gave the following figures and stated that France is thus spending \$1 per head annually for road maintenance. The French expert's address was in part as follows:

"France is about four times as large as the state of New York, its population is a little more than four times the state of New York; consequently with a population slightly over 9,000,000 in 1910, it means that this state would have an annual expenditure of \$9,000,000 for road maintenance. This does not include road construction by any means.

"During 1912, 29 of the states of the union expended \$62,691,425 on the construction of roads. The total population of these states is 61,261,000, so that the expenditure in these states figures out at practically at \$1 per head. The majority of these states, however, were experiencing abnormal road expenditures, which expenditures will have to be continued for some years. France spends her \$1 per head practically on road maintenance and these states have been spending \$1 per head practically on road construction. Many of the states in your country have not yet learned the lessons of road maintenance, but if it is on a par with that in France it will practically mean a sum equal to that used on construction.

"The original cost of construction of French roads was \$12,040 per mile for a hard macadam surface. Hard road construction, and the agitation for good roads in France began 150 years ago, under Napoleon I, and the beginning of the present network of French roads radiating from Paris dates from 100 years ago. Most of the roads in France, even the earliest, were of macadam construction.

"France has to date 340,000 miles of roads, and in the last

century has spent \$1,300,000,000 on these. Of this amount \$400,000 has been supplied by the central government to the heads of the roads departments throughout the country for a period of 70 years, name, 1820 to 1897. Since 1890 the work has been going on at a slower pace with smaller appropriations, most of the useful work having been done prior to that date. This means that the central government of France during those seven years appropriated \$6,000,000 a year in the building of roads. During that time the appropriation for building smaller roads was approximately the same as that for maintaining the national highways. Up to the opening of the European war, the French government was spending \$45,000,000 for maintenance alone."

BLADE SPREADER FOR ELLIPTIC SPRINGS

The spreader consists of a piece of bar steel, bent into a U shape as shown, with small projections in the inside of the lower ends. A bolt is run through holes drilled in the sides

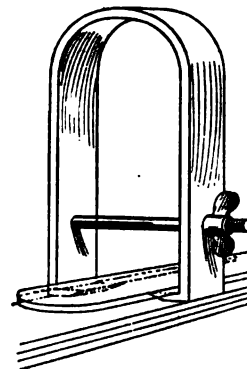

and a thumb nut used on the threads. The projecting ends are filed to a chisel edge.

In use, the sharp projections are inserted between the blades of the spring and the nut is turned up. This will separate the spring parts so that oil can be readily placed between them.

HENNEY CO. MOVES TO "TIGER" PLANT

The various departments of the Henney Buggy Co. have been moved to the plant of the Tiger Vehicle Co. Both plants are located at Freeport, Ill., and are the property of the Moline Plow Co. The body department of the Henney Buggy Co. plant will remain in operation in its present quarters and will employ in the neighborhood of 100 men, while the remainder of the Henney plant will be used for storage purposes.

The Tiger vehicle plant is larger and more modern and adequate for construction of the output of both companies and therefore it was deemed advisable to occupy the newer building.

For the present there will be about 150 men placed at work at the Tiger plant, but this number will be added to as business demands. The output will include all jobs which were formerly manufactured in both plants.

The office force of the Henney plant with some from the Tiger plant will occupy the spacious office quarters at the Tiger company plant.

GAS-ELECTRIC TAXICABS

That the Mason-Seaman Transportation Co., New York City, will probably employ the combination of the gasoline engine and the electric motor in its taxicabs, is stated by W. H. Barnard of that company. Mr. Barnard states the company is at present experimenting with a new 1,000-pound cab which will be propelled by the above system, the invention of Mr. Rockwell, also of that company.

FIFTH ANNUAL CONVENTION OF ELECTRIC VEHICLE ASSOCIATION OF AMERICA

The Electric Vehicle Association of America held its fifth annual convention in Philadelphia, October 19-21. There was an attendance of about 500, representing the passenger and commercial vehicle departments of the industry, together with battery makers and other builders of component parts, such as motors, tires, frames and chassis necessities. Over half the delegates were from central station interests, concerns manufacturing electric current for varied purposes.

It seemed to be the consensus of opinion that the electric vehicle industry has not made the progress it should and greater activity was necessary.

James H. McGraw, publisher of the *Electric Railway Journal*, read a paper in which he endeavored to explain why the industry has not progressed as the conditions of the time warranted. Mr. McGraw regards the present condition of the industry unsatisfactory for three reasons: First, the novel character of the business has been depended upon to carry the business to a point where exhaustion has set in. Second, those responsible for the administrative conduct of the business have done little in a constructive or creative way to open up new lines of business and have depended too much on the routine of subordinates. Third, the central stations have not co-operated to the extent they should have in pushing the industry.

Mr. McGraw thinks that all these ills can be corrected by simply applying to them such reasoning as will develop adequate comparison with progress made in other lines of business, and by adapting principles which have been known to bring results.

Puncturing the \$500 Electric Prediction

J. Crawford Bartlett, of Philadelphia, read a brief paper answering a paper read some months ago by Dr. Steinmetz, the eminent electrician of the General Electric Co., wherein he prophesied the \$500 electric that will travel 20 miles on one battery charge and have a speed of 15 miles per hour. He predicted 1,000,000 of such vehicles within 10 years. Mr. Crawford said: "Dr. Steinmetz predicted an electric of 20-mile radius for \$500, and not an electric of 60 or 70-mile radius. I can take care of Dr. Steinmetz's \$500 car for \$7.50 or \$10 per month as he prophesied. We had that kind of a car 10 years ago, but who would buy it today? Before 1909 I drove to Atlantic City in a 1,200-pound electric car, but today the public wants heavier cars and now I ride in one weighing 3,200 pounds. The public today does not want your puny, weak electric, but is demanding the swift, sturdy, comfortable car that will go 75 miles on one battery charge. The greatest setback the electric vehicle industry received was the low-priced small vehicle of 10 years ago."

George H. Kelly, of the Baker Motor Vehicle Co., agreed with Mr. Bartlett that the public today wants the big car and not the little one. The electric vehicle makers are going to give the public what it desires in a car, rather than following a missionary course of trying to convince the public that it should use the light-weight, short-radius vehicle.

The Committee on Garages and Rates created much discussion when its report was read. The report contained a map of the Lincoln Highway, extending from New York to San Francisco. The majority of the report consisted of the tabulation of mileage on the Lincoln Highway, the ostensible inference to be drawn from the report as presented being that it was to show the possibility or impossibility of touring by electric from coast to coast. No sooner had the report been presented than George H. Kelly moved that it be laid on the table because the manufacturers of electric vehicles advertised their passenger cars for city use and not for country use, and that while the report on the map proved interesting information they were all wrong so far as the spirit of the electric is concerned. In America there are 225 cities of over 25,000 popula-

tion, and in these the electric vehicle manufacturer should hope to make his sales for several years to come, and to these centers the association through its Committee on Garages and Rates should endeavor to assist the industry.

Warm Discussion on Electric as a Touring Car

Immediately the convention was divided into two factions, those favoring the electric as a vehicle possible for touring, and those representing the industry considering it more in its present form as a vehicle for city use. P. D. Wagoner, of the General Vehicle Co., in siding with Mr. Kelly, believes that the public will not generally adopt the electric for touring purposes through the country until the speeds of the vehicles are higher than at present, and until batteries are perfected so that they will carry an entire day or until they are perfected along other lines which will permit them to be recharged or boosted in as long a time as it takes to fill a gasoline tank in a gasoline touring car.

The entire convention was not, however, of this belief. Day Baker, of Boston, Mass., and treasurer of the association, is a staunch believer in electrics and does his country touring in a machine that he has used for eight years. With it he regularly makes the trip from Boston to Providence, 46 miles in 3 hours, whereas the average gasoline car making the trip does it in two hours and thirty minutes.

J. M. Skinner, of the Philadelphia Storage Battery Co., believes that it is possible to use electrics for touring throughout all of the eastern United States, and corroborated his belief by citing that he has frequently made the trip from Washington to Boston without difficulty, averaging 50 miles per charge.

With the present charging facilities, there are only 50 charging depots on the line of the Lincoln Highway between New York and San Francisco, and of this number there are only 14 west of the Mississippi River. With the present distribution it would be impossible for the tourist to even get from New York to Chicago, as there is one jump of 123.2 miles in Pennsylvania between Chambersburg and Greensburg, where there is not a charging station. This is the longest gap between New York and the Mississippi. West of the Mississippi there are but three stations between the Mississippi and the Missouri at Council Bluffs. There is not a single station between Omaha and Cheyenne, and from the time you leave Salt Lake City you do not meet with another charging station until you reach Sacramento, Cal.

Electric Taxicabs in Berlin

An interesting part of the report was the fact that there are 600 electric taxicabs, or were before the start of the war, in Berlin, Germany. To keep these taxicabs supplied in batteries there are two battery maintenance systems in the city, one with 700 batteries, and the other with 450, the batteries having 250 ampere-hour capacity. These maintenance companies charge the operators 3 cents per kilometer for battery service, including minor repairs to the car, but not including washing and garaging. The chauffeurs receive as their compensation 25 per cent. of the fare, plus all tips. The expense of washing the cab is 25 cents, and one-half of this charge is taken out of the percentage earned by the drivers.

The changing of batteries is handled as follows: The drivers are required to report at the maintenance depots at specified hours for changing of batteries, this practice distributing the load and reducing the number of employes in the depots. When the cab reports for a fresh battery the odometer reading is taken, and collection is made of the chauffeur or driver for the previous charge. When it is noted that a certain minimum mileage cannot be secured from a charge the taxi is required to go to the shop for overhauling. At the charging station the workmen are paid a premium when the battery life exceeds 10,000 kilometers.

The following are some interesting facts in connection with this system:

Number of taxicabs in Berlin.....	600
Taxi speed maximum miles per hour.....	20
Taxi income average per mile.....	\$0.16
Battery capacity, at 5-hour discharge rate, A. H.....	250
Number of cells in battery.....	40
Life of battery plates, positive, miles.....	9,375
Life of battery plates, negative, miles.....	18,750
Time of battery change at depot, minutes.....	2.5

The prevailing conception that there are few electric vehicles in use in the different cities of Europe was fairly well exploded by P. D. Wagoner, of the General Vehicle Co., who has recently spent considerable time in Europe, investigating different aspects of the industry. Nearly every city in Europe has its quota of electrics. Thus Berlin in addition to its taxicab equipment has 24 electrically driven pieces of fire apparatus, 30 electric water carts for sprinkling the city streets, which are effecting a saving of \$400 per vehicle per year over the previous horse system, 67 electrics in the mail delivery service, etc. In Munich there are twelve three-wheel electrics used in the postal service, and Leipsig has 20 electric postal vans.

That the Electric Vehicle Association of America is not idle in its efforts to bring the electric vehicle before the attention of the postal authorities in Washington was well demonstrated in the report of the Committee on Parcel Post Delivery, which was delivered by J. H. McGraw, who is chairman of the committee. This committee has been in touch with the Postal departments, and has prepared a booklet entitled "The Electric Vehicle in Parcel Post Service for Economy and Reliability." Special letters, together with a copy of this booklet, have been sent to the President and his Cabinet, and to all members of the Senate and House of Representatives, to the Collectors of Custom of the principal parts of the country, to the postmasters in all cities of 10,000 population or over in the United States and Canada, and to all departments of the government, including army, navy, civil service, etc. The campaign was extended to Canada by having the Canadian Electrical Association take up the propaganda and spread it throughout the country.

The committee has gone further in developing the parcel post business in favor of electrics, and has secured detailed analyses undertaken by the Post Office department to determine the parcel traffic in each of 50 of the principal cities for specific periods. The combined figures for these 50 cities, which have a total population of over 25,000,000, show that nearly 11,000,000 parcels were mailed out from these 50 post offices during the interval of October 1 to October 15, 1913, and 3,500,000 parcels were received at the 50 post offices for delivery during the same period. The average weight per parcel was 1 pound 11 ounces and the average parcel charge 10 cents. The cost of delivery by automobile was 5 cents per parcel.

Claims \$700 Electric Impossible at Present

The closing session was animated by a discussion between electric vehicle manufacturers and central station interests on the possibility of the low-priced electric, namely, a passenger vehicle selling at from \$500 to \$700 and manufactured in large quantities.

T. L. Jones, a representative of the central station interests in Brooklyn, opened the question in his address when he asked what was being done to distribute information on electric vehicles throughout the country. "The passenger electric vehicle is too high priced," began Mr. Jones. "The only reason why central station companies are not using such vehicles is the high initial cost. In Detroit every central station salesman uses a gasoline car. If the electric vehicle manufacturers will go to the central station people with a \$700 electric car they will get enough orders to make its manufacture possible. Today the electric passenger vehicle is for the luxurious classes. According to the registrations of July 1, 1914, 80 per cent. of the gasoline passenger cars had a selling price under \$2,000, whereas 85 per cent. of the passenger electrics sold in excess of this price."

Mr. Jones contended that the sale of electric vehicles must be pushed by those people who profit by the sales, and the

four people who profit by the sales are the manufacturers of cars, the manufacturers of batteries, the manufacturers of such accessories as motors, tires, etc., and lastly the central station or electric power producing companies.

Battery Makers Criticised

Mr. Jones believes that the lack of mileage is a drawback to the present extended sale of the electric passenger vehicle. "The maker who says he has a 120-mile car," continued Mr. Jones, "has not such a vehicle. He may have it on a glass road and at a certain temperature, but not under normal traveling conditions. Real facts will be more effective than glaring statements."

Continuing Mr. Jones criticised the battery people on the ground that during the last two years there has been little progress made in chemical research, although there has been much progress made in the mechanical details of the battery. He spoke of the work the central station interests are doing in Brooklyn by distributing cards to electric truck makers, which enables them to stop at other depots for a boosting charge and secure same at the regular rate. In Brooklyn they are working to have decorative lamp posts fitted with charging plugs so that the scope of the electrics can be thereby increased.

The gauntlet hurled into the ring on the \$700 electric was immediately taken up by George H. Kelly, of the Baker Motor Vehicle Co., Cleveland, who, voicing the views of a part of the electric vehicle manufacturers, contended that it is practically impossible to build a \$700 passenger electric vehicle at the present moment. Mr. Kelly believes there is no demand for such a low-priced vehicle at the present time, but rather that the demand is for a good looking car with a mileage radius from 70 to 80 for battery charge. With a \$700 electric this radius would be approximately 30 miles, and the average speed of the vehicle lower than at present.

Concerning the possibility of central stations buying cheap electrics in large quantities, Mr. Kelly cited an experiment made some years ago in which a canvass was made of practically 1,700 different central station people as to the market for an electric to sell at \$1,200 and which would have a good mileage radius as well as an adequate speed. There were not enough prospects coming from the central station people to warrant the necessary expenditure for the production of such a vehicle.

"The low priced electric," Mr. Kelly went on to state, "is yet in the future, and its coming depends on the 6,000 different central stations in the country. If they can get together and place sufficient orders so that such vehicles can be manufactured on a quantity basis, it will be possible to produce such a car, and not until then."

"A further cost in the electric car," said Mr. Kelly, "is the mechanical work that must be looked after and which is not a factor in the low priced gasoline car. A loss of one horsepower in a gasoline car is almost a negligible factor, but is a big factor in an electric. Because of this the cheap electric must be a well built vehicle eliminating friction losses in order to conserve electric current.

"Two big arguments for electric vehicles are long life and low cost of upkeep, and these cannot be secured with cheap construction. After all, first cost is not the biggest factor, particularly if you are going to pay one-half the original cost for fuel to operate the car with during the first 20,000 miles."

According to J. C. Bartlett, a Philadelphia dealer and garageman who handles electrics, there is not any demand for the cheap electric and it cannot be manufactured and marketed for \$700. He referred to certain movements in the electric passenger field some years ago where efforts were made to market vehicles much under the present prices, and that these practically ended in failure. The public demands a luxurious type of car with power and mileage.

The Keystone Vehicle Co. has just completed 1,000 stretchers at its plant in Reading, Pa., to be used in the service of the Red Cross hospital corps by the English.

CONSTRUCTION OF PRESENT DAY AUTO "ROTTEN"—"NOT A RADICAL IMPROVE- MENT OR CHANGE"

W. A. Swan, who has a to-the-point manner of expression, has delivered himself in a trade journal communication on the subject that will interest all who look at the progress of the motor car as a vehicle that must be permanently reckoned with. He says:

The whole construction of the present day automobile (excepting perhaps the body and wheels) is rotten. I know I am stacking up against some pretty clever designers, but tell me what has been done in the automobile as we now have it, outside of the perfection of details that was not in the little \$650 Olds of the early 90s, or the big single-cylinder Winton of the same period. I will say there has been not one radical improvement or change.

Look back in the early stage of industry, when steam wore the crown and when Charles Duryea would argue with everyone that would argue with him that the internal combustion engine was the coming motor power. In those days Duryea, Olds and Alexander Winton were, you might say, the master minds. They are the ones who built the present automobile when it started.

Since then we have added improvements, of course. We have also added cylinders, added gears, added magnetos, added expense, added complication, until it compares favorably with the first class battleship, but always the same old machine. True, we get somewhat better results, but why wouldn't we? Haven't we been working on the same old thing long enough? And, haven't we added enough to get something?

The Car of the Future

Now, let me tell you what the motor vehicle will be not 50 years hence but 25 years from now. You can call it imagination if you wish, a dream or a nightmare, but before forming an opinion, think of the Atlantic cable, the telephone and wireless. The future truck will have for its foundation a chassis of standard design and measurement for the different sizes, say, 1,000, 2,000, 4,000, 6,000 and 10,000 pounds capacity. It will have standard springs and fittings. And will provide standard lugs and braces for the motor power. The power plant, I believe, will be operated by alcohol and perhaps it might be well here to give my reasons for such belief. It being a manufactured product, the quantity of which is unlimited, could be regulated to suit the demand. It is safer, cleaner and more agreeable to handle than either gasoline or kerosene and produces a more flexible explosion than either. And I might suggest that if the government would take up this matter of producing alcohol, instead of spending money in useless investigations, we would then get a price much less than that of gasoline at the present time.

The power plant will have standard bosses or projections to fit lugs and braces of the chassis with but three or four bolt holes to fasten it to the same. It will be completely self-contained. The motor will be self-starting, in fact, not the so-called self-starter of today, where we depend on acetylene gas, electricity, compressed air, spring movements or some other form of power. This term, like many more on the automobile, is used for the want of something better. There are no self-starters today. They are auxiliary starters. Our future machine will have auxiliary powers but they will be reduced to two, compressed air and electricity. The acetylene gas generator and tank will have passed away and the only place you will find the water-circulating pump or a carbureter will be in a museum and referred to as Ancient Motor Group. I know there will be a general smile of criticism all along the line when I say that you will find the magneto and that spider-web piece of construction called a radiator in the same group. The motor of the future may be a modification of the Knight, but

will not be as expensive in construction and will be much simpler. It will have no timing gears or camshafts.

Now let us see what we have under the hood. A plain symmetrically designed motor (and it won't be a two-cycle, either) with no poppet valves or springs, no timing gears or chains, no cam or connecting link shafts, no circulating pump, no magneto, no wiring, and no radiator. In addition to this, the motor being self-contained, can be removed for repair or replaced for a new one in less than one hour by the driver or by an ordinary mechanic.

The Things We Won't Need

Listen, did I hear someone say, this fellow has forgotten about his shaft drive connections, and universal joints? No, but you forget that we are 25 years older and have learned that we don't need any. Not even a clutch, and about that box, filled with chrome nickel steel with more or less grease and trouble mixed in, well you'll probably find that in the same museum with the motor group, but indexed as Ancient Transmission Group. When we have gone this far, we can naturally disregard the gearshifting mechanism, including levers, etc.

Now let's get back to the thing that won't drive when one wheel slips, commonly called the differential. We will have to get something here that will give us the results we require and the only way is to drive each wheel independently.

But how? Now we have three methods, bevel or worm gear, chain and internal gear. By the time we have the rest of this car worked out, I guess we will have decided that the internal gear is the thing. And then we shall have a standard size gear bolted to the wheel, with standard size pinions suitable for each chassis of given capacity. Somebody else said I've forgotten the steering gear. No, I haven't. That answers pretty well now, so we will continue to use it.

Now, in going over the above, it will be noticed that I have not attempted to suggest how any of the results are accomplished. But I do wish to say that I have my own ideas and know they are more possible than I would have believed the phonograph was 30 years ago, or wireless telegraphy 20 years ago.

Just as soon as the present automobile momentum dies out, someone will have made enough money to spend some of it in giving us what we really want.

FOREST NOTES

The town forest of Baden-Baden, Germany, yields an annual profit of \$5.25 per acre, or a total net profit of nearly \$67,500.

Outside of its use for fence posts, black locust finds its principal utilization in insulator pins and brackets for telegraph and telephone lines.

One hundred shade trees will be planted by the Massachusetts forestry association in cities or towns of four population classes which win prize contests for excellence in street tree planting.

The Russian government has placed an embargo on all kinds of lumber, to prevent its exportation; walnut lumber, including Circassian walnut, much prized by American furniture makers, is specifically mentioned.

It is said that the first sawmill in the United States was at Jamestown, from which sawed boards were exported in June, 1607. A water-power sawmill was in use in 1625 near the present site of Richmond.

NEW PLANT FOR DETROIT

American Auto Trimmings Co., Detroit, Mich., will build a four-story brick and steel manufacturing plant, estimated cost \$36,500.

AIDING APPRENTICESHIP BY MOTION PICTURES

By A. M. Boggs, M. A.*

The great problem which has confronted industry since the abolition of the old apprentice system is to find capable and trained workmen for any kind of skilled occupations.

From the industrial viewpoint there is decidedly something amiss in training boys for positions. To overcome this, the larger corporations have instituted corporation schools in which they endeavor to instruct their employes in cultural as well as in industrial subjects. But they have not as yet solved the apprentice problem.

How can we train our boys and young men adequately, accurately and quickly; how can we stimulate the man at the bottom to better workmanship and to ambition to rise? These questions confront every employer. A young man of collegiate training, applied recently for a traveling salesmanship in a large shoe firm. He was told it would take him at least five years to acquire sufficient knowledge of that particular method of making shoes to warrant his employment as an agent.

The old apprentice system would indeed require that long; under the modern apprenticeship two months would be more than adequate. The old relied on one man's teaching, the modern studies the methods of all similar industries comparatively; the old consumed years, the new, months. What is the modern apprentice system? Teaching industry by moving pictures.

The motion picture film is essentially the modern and efficient method of teaching industry. A two or three reel film of factory first makes graphic and tangible the process as a whole; the same film after several revisions discloses each department and the exact method and skill required. Reviewed several times more, the young man discovers his particular niche in the scheme of production and by careful study of the action involved readily masters the detail.

He has not spent years acquiring this knowledge, which is in point of fact more accurate and specific than if he had done so. He comprehends completely his part in the process; he knows what the next fellow is doing and why he does it, and most important for him personally he is familiar with the requirements for the higher step if he wishes to take it.

Some of the unions of the day tend to keep a man in one position. They discountenance ambition and endeavor to keep in ignorance every man who desires to rise by learning the next man's work. It is a well known law that a typesetter, for instance, must never, even in the greatest emergencies, take the place of a stone locker. The usual answer to such a suggestion is, "I don't know how to do it."

The value of motion pictures as an educational medium has passed the problematical stage. In the industrial world it is in its infancy. A few of the more progressive companies have made films of their works, mainly from the advertising viewpoint, not as a medium of instruction for their own employes and the world at large. The jealousy that exists between two manufacturers of the same products militates seriously against comparative study in the factories and the public rarely sees an industrial film.

During the past year an organization has been completed in Philadelphia for the free circulation and distribution of industrial and commercial films. The Bureau of Commercial Economics is an association of the leading institutions, manufacturers, producers and transportation lines of this country and abroad to engage in the dissemination of industrial and vocational information by the graphic method of motographs, showing how things in common use are made and produced, upon the recommendation of the leading educators of the country. The work

*Assistant Director, Bureau of Commercial Economics, Philadelphia, Pa.

of the Bureau is maintained through endowment funds and annuities and is purely philanthropic. No expense is involved for any institution to whom these visatures are sent; they are available only when admittance to the public is free.

The Bureau does not accept any remuneration for the exhibition of any film or slide, but such pictures are displayed for educational purposes only. The work of the Bureau began in Girard College, on October 2, with an audience of 1,000, on October 10 the equipment for the 21 introductory visatures was shipped to the University of Pittsburgh and is now being displayed by them in their extension work. A set has also been sent to the University of Wisconsin.

The second and third series of visatures are now being collated, each in turn will be sent to the University of Pittsburgh, by them to be sent to the University of Cincinnati, from there forwarded to the various co-operating universities in a tour across the continent. Co-operation of the universities consists in displaying the pictures, thus affixing their seal of approval as to character and quality and then circulating them in their extension centers at night to large audiences who are in sympathy with the work as their own university stands sponsor; for which work many states make appropriation. The Bureau displays its visatures in universities, colleges, technical and agricultural schools, high schools, public institutions, settlement houses, missions, commercial clubs, and trade conventions, and will in the summer time use powerful projectors, operated from auto trucks for exhibitions in parks, playgrounds, etc., for the general public.

The Bureau was founded solely with the idea of getting occupational films to the people; to teach industry through the eye; to open the vista of possibilities to everyone who is seeking a position or who is endeavoring to better his economic condition. The boy in school, who, as part of his school curriculum, the college man, the man of the street, who sees in these free lectures every field of compensated endeavor portrayed on the screen can select wisely and with full knowledge of the reason for his choice, his particular vocation and avocation in life. It ought to make fewer misfits.

FOOT-AND-MOUTH DISEASE QUARANTINES

When a case of foot-and-mouth disease is found upon a farm, that farm is absolutely quarantined by the state or local authorities. No produce of any sort can leave it, the owner is not even permitted to drive his horses on the public highway, and in some cases his children are not allowed to go to school until the exposed stock have been done away with and the entire premises thoroughly disinfected. Since the disease, moreover, is readily communicated from farm to farm by cats, dogs, poultry, and human beings, the local authorities exercise their discretion in determining what restrictions should be placed upon shipments of produce from the area in the immediate vicinity of the infected farm. Poultry from the uninfected areas in the various quarantined states can be moved freely without the least danger of spreading the disease or of injuring the health of the consumer.

SAXON ADDS LIGHT DELIVERY CAR

The Saxon company has branched out into the commercial field by adding a delivery car of 400 pounds carrying capacity to its well known two-passenger type and selling at the same figure of \$395. This vehicle is mounted on the same chassis as the roadster, and with its light weight it should have a big field among the various lines of business requiring quick delivery of light packages.

With practically the same bonnet and control features, the main change is the placing of an open-box type of body back of the driver's seat, which body has the same length front and back of the rear axle. The carrying space is 48¼ in. long and 38 in. wide, with the sides 45 in. high.

EUROPEAN WAR AND AMERICAN OBLIGATIONS

By V. Gonzales*

The facility with which the people adapt themselves to the most abnormal situations is once more shown in their attitude toward present conditions. The outbreak of the war stunned everybody, and at that time some exaggerated the troubles in store, many did not realize what the sudden stoppage of commerce would mean, while others predicted that a shower of gold would fall on the United States as a result of this land being the only industrial country at peace with unimpaired energies and productive capacity.

Shipping and banking were the two factors of the world's economic life most dislocated, and local affairs were thrown into a state of panic. Three months of war have been enough for the people to conform themselves, practically, to present conditions, and everyone is thinking, now, how to continue business under the (now normal) abnormality.

Every country has devised its own means of protection, local gold stocks have been locked and sealed and all have accepted the most unusual economic provisions cheerfully, and are facing the future philosophically, to say the least.

Trade, which has always been the most intelligent factor everywhere, is moulding itself and is overcoming many difficulties thought at first unsurmountable. Of course, there are still many problems to be solved, and many of them cannot be solved until the duration and extent of damages of the war are known. Among these the disposal of unmarketable products is the gravest.

How long the war is going to last no one can say, but there is no hope at present that it will end soon. We are "praying" for the restoration of peace, but what are we doing to bring it about? On the contrary, if what the press says is true, we are simply adding fuel to the fire by providing all kinds of supplies to the belligerents.

There would be for us no sacrifice too great if it would tend to end the war, but it is useless to plead for its termination. Individual interests would oppose it, and, in all probability, we shall continue to furnish supplies destined ultimately to prolong the war.

The War May Last for Years

Let us then, consider that the war is going to last, say, three years, as predicted by a high officer of the British army, and let us see what we should do to take care of our trade during this period.

The supremacy of guns prevail, and it is of no use to protest against the supremacy. Those who owe will pay, if they so desire—and those who are strong enough will confiscate, destroy or otherwise dispose of goods and means of transportation, as and how policy may dictate. However, we must continue trade, and the rest of the world must also do the same. Everyone will seek the best means of protecting himself as far as he can, and will take his chances.

As between trade surrounded by all classes of risks and no trade at all we must choose the first.

Credit Must Be Restored

Credit, which was the foundation of commerce, has almost disappeared, and its disappearance is curtailing all transactions. We must restore it, and, if we do, we must control it.

London was the center of the world's banking exchanges and the clearing-house for the foreign trade of all countries; the 90 days' sight draft on London was practically international money, and all banks and bankers would count as actual gold all that they had on balance with London banks.

The invulnerability of those banks, never questioned before,

is now impaired; the holiday week and the 60 days of moratorium have broken the confidence of the world, and in spite of the guarantee of the British government for pre-moratorium bills no one will, openly, take a 90 days' sight draft on London, whoever the drawer is and whoever is the acceptor.

Why Shipments Are Held Up

Shipments of raw materials all over the world are held up for want of a substitute for the 90 days' sight bill on London, and we, among others, are feeling the inconvenience thereof. Our candid demand for "cash against shipping papers" is holding back our own shipments to a large extent, and, outside of food products and war supplies, little of our manufactures are being sold to foreign countries. Our cotton crop, held back largely because the purchasing capacity of the world to buy cotton goods is reduced, will remain unsold for a longer time if we do not devise the means of selling it on credit as we did before. It is doubtful whether cotton exporters will sell for drafts at 90 days' sight on London, and, if they do, it is also doubtful whether they will readily find buyers for those drafts.

Must Find a Substitute for London Bills

We must, therefore, find a substitute for the 90 days' sight draft on London; the earlier the better. Then we must also find the means of extending commercial credit to our foreign buyers, because if we do not sell on credit our sales will be greatly curtailed; neither will it be to our benefit to lessen our production nor to burden ourselves with an increasing quantity of unsold goods.

In order that we may know exactly what is needed in both directions and provide adequate means, it is necessary to look into the conditions of each one of our possible markets.

Foreign purchasing capacity must be considered first, for a country cannot buy unless it can sell what it produces or borrow money. Borrowing of money being at present out of the question, the first factor is practically the only one to consider. Then shipping and financial facilities, so unsettled since the beginning of hostilities, should be studied.

Latin America is our most expectant market, not because of its proximity, which does not apply at all parts, but because of its present business capacity as a whole.

Although forming a group of 20 countries, its similitude of habits, language, business methods, needs, and other conditions justify it to be counted as one only. It has nearly 75,000,000 people and its actual imports exceed \$1,200,000,000.

Then follow Australia and New Zealand and the other islands of Oceanica; and subsequently, China and Japan, India and other British possessions, Dutch East Indies and the other continental countries of Asia; South and East Africa come next, then Northern and Western Africa, and finally Europe, where some countries are still at peace and open to trade. The warring countries also represent possible trade, although under greater risks of many kinds.

A Glance at Latin America's Trade Position

Latin America should be divided into two sections—North America and South America—considering in the first group Mexico, Central America and the Latin republics in the West Indies, and in the second, the ten countries of the southern continent. Their area, population, imports and exports are as follows (in thousands):

NORTH AMERICA				
	Area	Population	Imports	Exports
Mexico	767	14,000	\$97,886	\$150,203
Guatemala	48	2,000	10,062	14,450
Honduras	46	700	4,317	3,080
Salvador	7	1,700	6,173	9,929
Nicaragua	49	600	4,967	3,861
Costa Rica	18	400	8,778	10,432
Panama	32	400	9,872	2,065
Cuba	45	2,000	135,811	165,208
Dominican Republic....	18	700	9,272	10,469
Haiti	10	1,200	9,877	17,285
	<hr/> 1,040	<hr/> 23,700	<hr/> \$297,015	<hr/> \$386,982

*Foreign Trade Department, National Association of Manufacturers.

SOUTH AMERICA

	Area	Population	Imports	Exports
Colombia	438	4,500	\$23,965	\$32,222
Ecuador	116	1,500	11,489	12,692
Peru	696	4,800	30,548	44,472
Bolivia	609	2,300	19,309	35,148
Chile	291	3,300	122,076	139,878
Argentina	1,136	7,000	408,712	469,999
Paraguay	98	700	5,190	5,462
Uruguay	72	1,100	51,355	53,040
Brazil	3,218	20,000	308,244	362,795
Venezuela	394	2,800	18,030	29,484
	<u>7,068</u>	<u>48,000</u>	<u>\$998,918</u>	<u>\$1,185,192</u>
Total	8,108	71,000	\$1,295,933	\$1,572,174

Mexico and Cuba represent about 80 per cent. of the trade of the first group, and Argentina, Brazil and Chile about 80 per cent. of the second.

DESCRIPTION OF A NEW TIRE HEATER

A new tire heater of a novel and practical design, combining many new features and advantages, is shown in the accompanying illustration. The one feature, which perhaps more than anything else distinguishes this tire heater, is the portability of the apparatus. It can be set up in any part of the building or yard in a few minutes and when not in use, may be stored away without taking up valuable floor space.

The apparatus consists mainly of a cast iron combustion chamber, having eight separate outlets leading toward the tire.

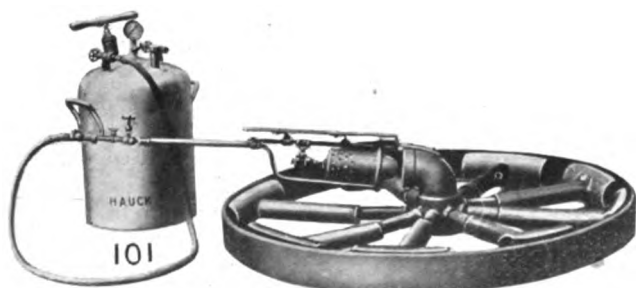

Hauck Tire Heater, for heating wagon and truck tires

These outlets are equipped with sleeves which can be adjusted instantly to fit any size tire from 20 in. to 80 in. in diameter. A special hood at the end of these sleeves confines the flame to the tire and prevents any heat from escaping.

A large kerosene oil burner is attached to the combustion chamber and connected to a 12 gallon oil storage tank by a special oil resisting rubber hose. The powerful blue flame from this burner is thrown into the combustion chamber and forced into the eight outlets, with the result that practically eight separate flames are thrown against the tire. This novel arrangement is said to heat a wagon, truck or locomotive tire in a few minutes and at a cost of only a few cents.

Aside from heating tires, the burner, which is detachable, can be used as a brazing and heating torch for brazing cast iron, steel and copper, bending and straightening iron frames and plates, melting babbitt out of bearings, shrinking and expanding machine parts, annealing and tempering, preheating for welding, etc. The Hauck Mfg. Co., 140 Livingston street, Brooklyn, N. Y., are the manufacturers.

TOTAL COST OF A ROAD KEPT GOOD UNTIL THE BONDS ARE PAID OFF

While it is frequently easy for a county to issue bonds and borrow money for improving the local highways, the raising of the money to retire those bonds at maturity is often not so simple. Many counties, in borrowing money for bonds, figure that the amount of money raised represents the total cost of

the road, forgetting that the road must be maintained and repaired if, at the end of the term of the bonds, the county is to have anything to show for its investment.

The question of financing country road building is discussed fully in Department of Agriculture Bulletin No. 136, entitled "Highway Bonds," which is written by the Office of Public Roads in collaboration with James W. Glover, professor of mathematics and insurance, University of Michigan. In this bulletin the authors discuss fully the various methods of financing road building and retiring debts for road construction, and also deal frankly with the actual total cost of a road during the life of the bonds. On the total cost of a road, the authors cite the following two examples as affording at least a basis for estimating the total minimum cost of a mile of road:

Total Cost of a Mile of Road Built With 20-year Bonds

Bituminous-macadam:	
Cost of construction (\$10,500) under 5 per cent. serial bond with interest for 20 years.....	\$16,012.50
Cost of annual repair and maintenance (\$600) for 20 years	12,000.00
Total cost for 20 years.....	\$28,012.50
Brick:	
Cost of construction (\$18,500) under 5 per cent. serial bond with interest for 20 years.....	\$26,426.73
Cost of annual repair and maintenance (\$300 for 20 years	6,000.00
Total cost for 20 years.....	\$32,426.73

The authors point out that the actual cost of building and maintaining a specific highway can be determined only after the character and volume of traffic and actual wear and tear have been studied for a series of years. The figures quoted above, of course, will not apply to ordinary macadam, gravel or clay roads, but in all these cases the interest on the bonds must be met, and there must be expenditures to maintain them in condition. The poorer the drainage and the less permanent the character of the road foundation, the greater must be the percentage that repair costs will bear to the first cost. Similarly, the question of whether the actual surfacing is designed to withstand the character of traffic and weather to which it is subjected also has an important bearing on what it will cost the county to keep the road in such shape that when the bonds are paid the locality still will have a valuable property to show as a result of its borrowing and repayment.

DODGE ADDITIONS

Dodge Bros., Detroit, Mich., manufacturers of the "unknown" car, are still expanding their already large plant. A new pressed-steel shop and the doubling of their general offices have been let to the contractors and will mean an outlay of \$650,000. The pressed-steel plant will be a four-story building, 400 feet long and 77 feet wide which will have a total floor area of 130,000 square feet. It will be connected with the new assembling plant through an extension of the latter building by 189 feet. A wing will also be built 89 feet long and 77 feet wide, to connect it with the loading platform, railroad tracks and driveways. The first two stories will be of steel frame and concrete throughout, while the two other stories will be of reinforced concrete. The exterior will be similar in construction and design and color to the other Dodge buildings. The general office and administration building, which now is a two-story structure, 116 x 52 feet, will be enlarged to be a four-story building, 320 feet long and 72 feet wide.

FORD'S NEW L. I. PLANT

Ground has been broken for a new eight-story building of concrete, steel and brick construction for the Ford Motor Co., at Honeywell street and Jackson avenue, Long Island City, east of and adjoining its present building. The new building will have a frontage on Jackson avenue of 325 feet and will cost about \$650,000.

Paint Shop

FAULTS IN VARNISH AND ENAMELS

Tackiness

This most annoying trouble is often traceable to a soft undercoat. Sometimes the old fault of putting too much driers in undercoating is the cause, by giving the paint a hard surface before the air can oxidize the body of the paint. In such a case the oil never hardens, and would gradually cause the softening of the surface coats, even hard church oak varnish becoming tacky by this means.

If varnish is hurried on to a coat of paint that has not become properly dry a similar result may follow. When the trouble is but slight, it may often be cured by a coat of whiting or Fuller's earth made into a creamy paste with water only, and left on for a couple of days to extract the greasy exudation. It is then to be washed off with hot water, and after drying for a few hours a coat of hard varnish will effect a satisfactory finish.

There is a tackiness due to the presence of rosin oil in place of linseed oil in the manufacture of some of the commonest qualities of varnish, but varnish makers of high standing do not risk their reputation by using this undesirable substitute in any of their products.

Some slow-drying varnishes are tacky for a few days after drying before finally hardening off. This should not be regarded as a fault, though in some cases a special varnish may reasonably be made of quicker hardening qualities on being reported so to the makers. Such varnishes are usually the most durable after hardening—among them would be found the finest finishing coach body varnishes. In these cases the varnish passes through three stages—in drying, the tacky, and the hardening, like slow oil gold size, which depends on this peculiar quality for its merit in holding the leaf firmly while afterward hardening quite independently of atmospheric contact.

Cracking

So much has already been said on this subject in this journal that it will only be necessary to summarize here the causes and their avoidance. Various causes produce cracks of distinct character. The addition of terebine to a varnish for hardening will often cause cracking, especially when exposed to direct sunlight. These cracks at first give the varnish a silky appearance, due to their hair-like fineness and great numbers. Subsequently many of the cracks open out wider under atmospheric variations. But the crack due to terebine is always sharp and clean, and mostly straight, as though cut with a razor edge, crossing the work in all directions.

Terebine is sometimes used in graining color and in other undercoats prior to varnishing. In such cases the cracks will show their origin to be in undercoats by the depth of every crack, while if the varnish only be at fault the undercoats will in many parts remain unaffected.

The application of any hard, quick-drying coat of paint or varnish on a soft undercoat is liable to cause cracking, and would affect any super-coat likewise. This may sometimes be traceable to a glaze coating prior to varnishing, to a gold size and turps flattening coat on an oily ground, or to a hard drying varnish on a soft ground-work.

Gold size cracks are distinguishable by their usually lying in the direct line of the brushwork, and having soft, round edges, turning inward, the cracks being less numerous but more open than terebine cracks.

The application of a coat of size upon a hard, non-porous ground prior to varnishing, such as sometimes occurs when revarnishing old work in cheap jobs, if the size be fairly strong, will sometimes result in cracks, the cracks being notably of polygon shape and the edges having a tendency to curl outward.

Cracking sometimes occurs only where knots exist in the woodwork. That is generally due to the preliminary use of too much shellac or patent knotting destroying the porous key of the wood, leaving no hold for the priming coat. As no affinity exists between the shellac and the oil paint, the latter cracks by irregular contraction and expansion of the paint and the wood. The remedy is to scrape down to the bare wood and to paint again without fresh knotting, or after a thin coat of reduced strength, in case of new woodwork.

To avoid tendency to cracking, there is no better course than to take care that every coat prior to varnishing be thin, and allowed to dry hard before applying the following coat. It is important also that no quick drying medium, such as gold size or terebine, be employed in painting over a coat mixed with ordinary linseed or boiled oil, though the reverse order may be employed without danger, and in case of quick drying paint being necessary, employ no oil at all, except for the priming coat on new wood, and the finishing varnish may then be elastic or hard as desired, without danger of cracking. A hard varnish may be used as an undercoat, and an elastic finishing varnish over that. But the reverse order may give rise to the fault under notice.

Silkiness

The fault known as "silkeness" is due generally to applying one coat too soon over another in varnishing over black japan or over a previous coat of varnish. The fault is most noticed when black japan is the undercoat, and appears to be caused by the absorption of much of the oil from the finishing varnish, and the subsequent extremely fine cracking of the gum in the remainder. The cracks are visible under a strong magnifying glass, though not to the naked eye.

There seems no way of ensuring the avoidance of this mishap except when once noticed to avoid using the same two articles in contact with each other afterward. The remedy is a careful flattening down with pumic blocks, and revarnishing. Two coats are generally necessary for a good finish after this trouble.

Patchy Surface

If a painter tries to economize his outlay by adulterating varnish with linseed oil, or to improve upon the skill of the varnish maker by mixing two varnishes together, he may look for this trouble.

In the course of varnish manufacture all necessary ingredients are amalgamated at exceedingly high temperatures, 300 to 500 deg. F., as they would otherwise refuse to blend into a homogeneous product. It is therefore out of all reason to expect to blend more ingredients or various products at normal temperature, and even if heated together, none but the actual varnish maker would know the correct time to say that the desired blending had taken place. If the painter will first try very small quantities in a clean glass phial, he will clearly see that all his attempts to blend oil with varnish are practical failures, showing a clouded or a stinky mixture, however agitated.

No other cause except a faulty ground-work or inexcusably inferior quality of varnish can usually be held responsible for this trouble.

CANADIAN PAINT BRUSH SITUATION

The Canadian paint brush makers are experiencing difficulty in adjusting selling prices to the present cost of the basic material, says Consul Felix S. S. Johnson, Kingston, Ontario. Bristles from a semiwild hog of Russia and Siberia and also a black hog of China have advanced 50 per cent. since war was declared, on account of the practical stoppage of shipments from those countries.

Other hairs used in brush industry are also scarce. Camel hair is dressed only in Germany; the trade of dressing this very fine and short hair requires great skill. It is not known where it can be secured when the present supply is exhausted. Badger skins from which the badger hair is obtained comes entirely from Russia. The advance in this article is nearly 100 per cent.; in fact, it is not a question of what one has to pay, but whether it can be bought at any figure.

Germans and others in and around New York City have been dressing bear hair in large quantities for the past ten years, and as a result the Canadian trade is not obliged to purchase in Europe. Ox hair, generally called Siberian ox hair, comes from the inside of cows' ears. These ears were formerly taken to Germany, where the hair was cut out, the skin used for other purposes, and the gristle of the ear used for gelatine. During the last few years the dressing of cows' ears has been done in the United States.

VARNISHING RUNNING PARTS

Not infrequently some otherwise exceptionally good workmen fail to become really high-class finishers upon carriage running parts. Failure appears to be due to the fact that these men overwork their varnish—dwell too long over the brushing out. In other words, and speaking in the blunt phrase of Tom Watson, they are teasers. A first class gear finishing varnish does not take kindly to much brushing and it should not receive much. The first thing the varnisher should learn is the art—for, after all, it is nothing else—of brush-working his varnish. Upon running parts this should consist, in case, for example, of the gear, of flowing the entire structure over with a swimming coat of varnish. Then return to the starting point and lick up with brief strokes of the brush the surplus material which refuses to mass itself in place as the varnish flows to its permanent position upon the surface. Further brushing is not only unnecessary but a positive detriment to the finish. A flowing varnish, which all good varnishes are, should be permitted, once upon the surface, to fulfil its destiny. Over-brushing is an inexcusable fault. Why practice it?

HOW TO USE GLUE

For glue to be properly effective it requires to penetrate the pores of the wood, and the more a body of glue penetrates the wood, the more substantial the joint will remain. Glues that take the longest to dry are to be preferred to those that dry quickly, the slow-drying being always the strongest, other things being equal. For general use, no method gives such good results as the following:

Break the glue up small, put it into an iron kettle, cover the glue with water, and allow it to soak twelve hours. After soaking, boil it until done. Then pour into an air-tight box, leave the cover off until cold, then cover up tight. As glue is required, cut out a portion and melt in the usual way. Expose no more of the made glue to the atmosphere for any length of time than is necessary, as the atmosphere is very destructive to made glue. Never heat made glue in a pot that is subject to the direct heat of the fire or of a lamp. All such methods of heating glue cannot be condemned in terms too severe.

Do not use thick glue for joints or veneering. In all cases work it well into the wood, in a similar manner to what painters do with paint. Glue both surfaces of your work, except in cases

of veneering. Never glue hot wood, as the hot wood will absorb the water in the glue too suddenly and leave only a very little residue.—Scientific American.

RESINS FOR VARNISHES

The resins used in fixed oil varnishes are, in their natural state, insoluble in linseed oil and in turpentine. It is only after undergoing a process of roasting or distillation that they become soluble, and in this operation they lose from 20 to 25 per cent in weight. In the process of manufacture the resin is first melted down in a kettle, and after it has been sufficiently heated the proper quantity of linseed oil, also hot, is added, and the mixture heated some time longer to effect a combination between the oil and resin. After cooling somewhat, sufficient turpentine is added to properly thin the varnish.

NEW DECATUR BUGGY CO.'S RECEIVER HELD LIABLE

H. H. Haines, receiver of the New Decatur Buggy Co., of Hamilton, O., will be held personally liable for the payment of all obligations which he contracted as receiver of that company in excess of the authority granted him by the court, is the opinion handed down by United States District Judge Hollister, October 29, in the United States District Court on the final hearing of the intervening petition of the Buckeye Wheel Co. in the case of Harry W. Quackenbush vs. Harry H. Elwood, the New Decatur Buggy Co. et al., in which Haines was appointed receiver for the buggy company. In his opinion the court said in part:

"In his case the receiver was authorized to carry on the business, and, for the purpose of doing so, was expressly authorized to borrow a sum of money. This was not only a limitation on the amount of money he might borrow for the purpose, but was a negation of any authority to involve the receiver, as such, in any expense in running the business greater than the amount authorized to be borrowed by him for that purpose. He had that much money to spend and no more. If he incurred debts beyond that sum he did that which he had no authority to do, and the court will require him to personally make good all obligations which, without authority, he, as receiver, entered into.

"It appears that the receiver with authority to contract an indebtedness on receiver's certificates in the sum of \$5,000 owes merchandise creditors a large sum of money. His accounts will be surcharged, as prayed in the intervening petition of creditors. If necessary he will be required to repay such sums as have been allowed him by way of compensation.

"If it should be necessary to determine the questions of priority between different classes of his creditors, the holders of receiver's certificates, issued under order of the court, will be awarded priority."

T. P. HOWELL & CO. SUPPLIES LEATHER FOR REFURNISHING ROOM OF PRESIDENT WILSON

T. P. Howell & Co., of this city, the largest tanners and manufacturers of upholstery leather in the world, today shipped to Washington a consignment of leather to be used in reupholstering the furniture in President Wilson's private room in the United States Senate. The shipment fulfills an order received by the Newark firm two months ago. The order was secured in competition.

The leather is dark maroon in color and the finest quality of hand-buffed steer hide. It will be used on all the furniture in that particular room. This is the first time the furniture in the President's Senate room has been "done over" in leather, and T. P. Howell & Co. are particularly pleased that the order should come to Newark.—Newark Evening Star, October 27, 1914.

WITH A CAR AT THE FRONT

The following, extracted from a long letter, accompanied by photographs, is written by W. F. Bradley, a special writer for *The Automobile*. It is interesting as showing how the motor vehicle lives and dies in war, and its varied uses. The communication bears date of September 25:

We speak and write of the importance of the role played by automobiles in this great war, but no man, who has not been on active service, can appreciate to the full the work done by mechanical transport. The opportunity presented itself to go on active service as a motor car driver, doing the same work as well known race drivers and thousands of more humble motorists. I accepted this offer, and at the present moment am wearing the British uniform, driving officers from the base to army headquarters, from headquarters to the firing line—doing any kind of work which may be required. This is the story of a spell of service, a period in which days were lost count of, for the completion of the task and not the setting of the sun decided that rest should be taken.

I was given orders to report at the depot six miles away within half an hour. Officers never make use of the railway—unless they are prisoners. The only rapid means of locomotion is the automobile. The trip from Paris to the nearest point of the firing line can be made in three to four hours with a fast car. The average time on the train is from 20 to 23 hours.

While military men are making the greatest possible use of cars, civilians are being restricted to the utmost. Within the zones of the armies it is absolutely impossible for a civilian automobile to penetrate. Newspaper men in particular have made wily and determined efforts to break through, but without success.

The freedom of the main roads from all other kinds of traffic and the right of way which the military man enjoys make it possible to maintain a high average rate of speed. A pace of 30 or 40 miles an hour can be set and maintained for hour after hour.

Most of the cars seen on the road are high grade machines bearing all the evidences of hard and continuous work. In a little village where I was held up for a few seconds, a handsome Rolls-Royce with a costly boat type body appeared. A German helmet was tied to the radiator cap, the body was thickly coated with mud and tied around the car were cans of gasoline and boxes with provisions.

The battle of the Marne had come to a close about a week before I ran through this district. But all the ravages of war were to be seen.

Between Meaux and Chateau-Thierry, about 40 miles up the river, not a single bridge has been left intact. At one of these towns on the River Marne the bridge had been blown up by the French at 2 p. m. At 2 o'clock the following morning German officers approached this bridge in a Benz limousine. Not knowing that it had been demolished, they rushed across at high speed to fall to an instant death in the water.

What most impressed one as a tourist was the utter untidiness of the whole countryside. One hill had been under heavy shell fire. Big trees had been cut through by shell, innumerable branches had been carried away, every telegraph pole was broken and telegraph wires hung stragglingly.

Between the Marne and the Aisne valleys is a 30 to 40 mile stretch of country through which the German armies made their retreat after the Marne battle. This was a deserted country, not destroyed, but scoured clean of food and fodder. Despite the heavy traffic the main roads had kept in a good condition, only the side banks, which are usually trim and neat, had been trampled into a bed of mud.

At British Headquarters

The full extent of the motor transport service in connection with the British army was realized in the village selected by Sir John French as his headquarters. About two miles before

reaching this village hundreds of horse-drawn army transport wagons were passed in muddy fields. It was very rarely that I saw these vehicles in actual service other than bringing up provisions for themselves.

A mile outside of the town motor lorries were lined up in close formation for more than a mile. These were nearly all commercial vehicles which had been taken out of active service at a moment's notice and carried the advertising matter which forms such a distinctive note of this war. These vehicles formed a reserve called upon in rotation to go to the railroad depot a mile to the north of the town and there load up with food and ammunition to be taken direct to the firing line.

Originally the military plan was to make use of motor trucks for carrying supplies from the railroad to a point a couple of miles back of the fighting line, from which point the final distribution was made to the men by horse wagons. This plan has been altered, the motor trucks now going right up to the firing line and delivering direct to the men in the trenches.

During the six or seven weeks the war has been in progress the British motor transport service has settled down to business in a remarkable manner and is now giving results which in the opinion of all officers are amazing. The army generally is showing itself highly efficient, but the motor transport service is certainly the best of its many branches. Since the outbreak of hostilities the weaklings and unsuitable types which were pressed into service too hurriedly have been abandoned and have been replaced by new trucks supplied by English factories. Judicious classification has also been indulged in, so that five-mile-an-hour lorries are no longer made to keep pace with twelve-mile-an-hour machines.

No work is being done away from made roads. The absence of cross-country work is made possible by reason of the network of roads in this part of Europe. One of the chief defects of several of the English makes of lorries is the lack of clearance. I noticed several cases of rear axles designed with a view to rapid inspection and quick dismounting, but without any thought that the vehicles might have to operate on mud roads. If the war continues throughout the winter, which is likely, many of these trucks will be incapable of operating on the third and fourth class roads.

Very useful, if not indispensable, accessories are differential locks and towing hooks, front and rear. Despite careful driving a truck would sometimes get off the road into the mud. As all journeys are made in convoys, it is always possible to get the vehicle out if hooks, a rope and differential lock can be used at once.

Generally cooling and lubricating systems are proving satisfactory. Up to the present all the motor trucks have used gasoline only. The British army has brought its entire supply from England, either in two-gallon cans or in big kegs, and has never had to make use of such alternative fuels as benzol and alcohol.

On the public square of the headquarters town there was an even greater scene of motor activity. Here were to be found 200 motor vehicles of every type. There were motorcycles, touring cars of all types, motor ambulances, trucks, omnibuses and a well-equipped motor workshop. A portion of a covered market at one end of the square formed a gasoline and oil depot. Close by was a van stocked with tires and accessories, while in the center of the square was the motor workshop. The equipment of this latter was simple but effective. The vehicle was an ordinary four-ton chassis with a big platform body carrying a tarpaulin cover. Inside the body was a twin-cylinder Douglas motorbike motor generating current for electric lighting and for driving a lathe. Sixteen skilled mechanics were attached to this shop and at the time of my visit were working a day and night shift. A surprisingly extensive range of repair work was undertaken.

For every hour spent in the saddle, army officers in these days spend 50 hours in an automobile. Horses are maintained, but with the exception of cavalry officers it is a rare feature

to see an officer on horseback. No particular type of touring car appears to be preferred, although English officers have a preference for a comfortable rather than a very fast car. The machine ought to be able to touch 45 miles an hour with ease and to keep up 40 miles an hour for long periods.

In most of the cars the gasoline tanks were too small, for in a war-devastated country it was often necessary to carry sufficient fuel for journeys of 400 to 500 miles.

An adequate oil supply was also necessary, and a car which could run very long distances without the bonnet being lifted for renewing the oil had an advantage over others.

Tires Changed Under Fire

Spares which are unnecessary in civil life are indispensable for active service, but not many cars had the necessary space for carrying these. Detachable wheels are a valuable acquisition. One one occasion when drawn up for a tire change we were fired on by German stragglers hiding in the woods behind the Allies' lines. The change was made while shots were flying. Under such circumstances there was a wonderful amount of satisfaction in knowing that the change would occupy but a few seconds, for my car was fitted with detachable wire wheels.

An efficient system of lighting is indispensable. Electric lighting appeared to give the best results, but this system requires so little attention that there is a tendency among drivers to give it none at all, with the result that it failed them when needed.

NEW LIGHT BUILT-UP STEEL WHEEL

A steel wheel, built along the lines of present artillery wooden wheels, has been invented by W. Starley, an Englishman, and its manufacture has been taken up by The Jointless Rim Co., Ltd., Birmingham, Eng.

The Autocar, which hails this new wheel as something of great importance to motordom, states that the essential difference between the new wheel and other steel wheels is that it is built up with separate hollow spokes, which are attached to an ordinary steel tire rim at their outward extremity and wedged together at the nave as in a wooden artillery wheel.

The ten spokes have a U-section and are pressed from flat steel plates, the rounded portions of the spokes being on the outside. The open or inner side of each spoke has a flat plate, welded to it, completely closing it, the welding being done by the oxy-acetylene process. The nave end of the spoke is tapered just like a wooden spoke. When the ten spokes are assembled, the taper leaves a slight space between adjacent spokes, the opening being the widest toward the center. These taper spaces are, in the process of assembling, filled with steel wedges. The outer ends of the spokes fit over small lugs, which are let into the tire rim from the under side and afterwards riveted over. No welding or brazing is required at the rim, as the hollow spokes fit over the lugs and remain firm.

When the wheel has been roughly assembled, the tire rim is placed in a large vise which grips it at three points, which the wedges already referred to are driven into. This produces a tendency in the spokes to spread, but, being prevented from doing so by the rim, and interlocking with one another at the nave, the wedging action results in the spokes becoming firmly locked together. After the spokes are wedged the center is bored out to a circle, and inside a groove is turned into which is spun a steel liner. This, in turn, is bushed with brass, to prevent rusting.

A steel flange is fitted on each side, being held in place by spinning over the ends of the steel and brass liners. The lateral strength of the wheel does not, however, depend on these flanges, which are only fitted to give the wheel a finished appearance. The outer flange is fitted with a brass hub cap so that car makers are not even called upon to provide this; they have nothing to do except to fit the wheels to their hubs.

The methods of attachment is that known as the stud system,

each alternate spoke being drilled for the studs or bolts and a cross liner of brass fitted into each hole to prevent rusting and to act as a driving support for the stud.

Before assembling and after completion the wheel is treated by the Fermangan anti-rusting process inside and out. The total saving in weight in a set of five 26 x 3 inch wheels is about 13 pounds.

This wheel would seem to not only have the stability and strength of the wooden artillery wheel, but the heat radiating and resilient qualities of the wire wheel. On the other hand it is not to be forgotten that a very high factor of safety is required in a wheel depending for its strength on oxy-acetylene welding of small steel parts and on wedge action of other steel parts, both these elements calling for highly skilled workmanship to secure uniform results.

[This does not appear to be as simple and strong a construction as the Standard wheel one time made in Toledo, but now in the discard].

WELDING STEEL WITH SAND

Welding with sand is very popular with blacksmiths in all lines of work. When soft steel first came into use, the man at the forge found no little trouble in making good welds.

At that time, compound was used altogether, but now it is different, as about two-thirds of the smiths are using sand. I am using it altogether on soft steel and axles. It is not fit for tool steel. For that, compound, of which there are several good ones on the market, must be used.

For the benefit of the blacksmith who has not tried sand, I will give the benefit of my experience; and I wish to say, that those who have not used it don't know what they have missed.

Use clean, fine, dry sand, which is free from clay plasters. It is astonishing what an effect this has on soft steel. It is a purifier and restorer; but only to soft steel and common iron. The latter is harder to weld.

To test the restoring qualities of sand, take an old steel axle, and have a pan of sand close to side of fire. Get a strong, white heat on the laps; so strong that it is partially burned. Let the helper take out one and you the other; stick both ends in the sand, simultaneously, and be quick about it. Remove to the anvil and weld; you will be surprised at the result.

This is merely an illustration to show the restoring and purifying powers of sand; for every day welding, apply sand by throwing a little on the laps while the heat is just beginning to sparkle.

When you are welding together two pieces of steel, dip the points in the sand; put back in the fire, and get quite a strong heat, being careful not to strike a hard blow at first. Stick it together and it will weld up nicely at one heat.

For forging out irons solid by splitting, soft steel is better than Norway iron, as it is not so liable to crack nor gall. Of course, it requires a little more elbow grease. Don't overheat in forging out solid pieces, as the beauty of it is the grain runs both ways.

The steel used chiefly for auto axles, lamp brackets, running brackets, etc., is soft and when hot blends very easily. It is easily welded but only with compound, and at a very low heat.

In straightening up an auto axle, don't heat to a cherry red, as overheating makes it too soft in spots, and it will spring again in the same place.

STANDARD WELDING ADDS THIRD BUILDING

The Standard Welding Co., Cleveland, O., is building the third large addition of the year to its plant. The newest structure is of structural iron, with corrugated asbestos, metal reinforced roofing and siding. The dimensions are 60 x 240 feet by 30 feet high. It is to be devoted entirely to the storage of rims and will accommodate approximately 100,000 rims of various types.

TO THE SOUTH

It is the fashion now to talk about the south. Our eyes gaze over the equator. There are some business charts that traders ought to possess and study before making any definite move. They may be had from the Superintendent of Documents, Government Printing Office, Washington, D. C., for a nominal price. These are the publications:

Transportation Rates to the West Coast of South America,
South America as an Export Field,
Trade Directory of South America.

At the risk of seeming to teach a lesson, facts that need to be emphasized will be repeated. It is more than well to remember them.

First, the personal equation. It has been emphasized that the social feature, almost negligible in the United States, is an important factor in trade relations in Latin America. Business is conducted more slowly in general, correspondence and personal relations do not perhaps have so much of the "touch-and-go" character, and in all commercial transactions more stress is laid on both the forms and the spirit of courtesy than in the United States. Traveling salesmen will find that they can make more progress by taking their time in working up a personal acquaintance with the trade than by attempting, even with the most favorable terms to customers, to close a sale on the first visit; and a courteous letter, written in Spanish and directed especially to the person or firm addressed (in contrast to a circular or form letter), will probably prove far more valuable as an accompaniment of a catalog and price list than the mere catalog itself.

Fair treatment of the customer from the beginning to the end of a commercial transaction is of the highest importance. In the next year or two American goods will be likely to penetrate to every remote corner of Latin America. Under these circumstances dealers and consuming public alike will have their first opportunity to become acquainted with American wares of every sort and description, and it is of the highest importance that the impressions they receive, not only as to the quality of the goods but also as to fairness of treatment by American exporters, should be favorable.

Latin American merchants do not lightly change from firm to firm in their purchasing of foreign goods, and when they become assured of fair treatment from a particular export house their trade is likely to go to that house indefinitely. Much the same thing is true of the nations from which they buy, and with American goods once firmly established and American exporters found to be courteous and trustworthy, the future for our trade in Latin America will be assured.

Second, the condition of shipments. Perhaps the greatest objection to American methods heretofore has been that detailed instructions concerning packing and marking have been disregarded, with considerable damage and delay as a result. In many ports on the east coast of South America, and in practically all on the west coast, all goods have to be lightered to shore, and on landing are sometimes allowed to remain exposed to the weather for several days. The necessity for strong boxes and crates, well reinforced, is discussed in detail in "Packing for Export," obtainable from the Superintendent of Documents, Government Printing Office, Washington. Good, clear marking is of much greater importance than is generally realized, as the lack of these marks, or their failure to correspond to those in the invoice, often causes the goods to be held up in the customs for weeks and months. It is in many cases essential that the weight in kilos (kilo=2.2 pounds) be marked on the box, as the capacity of many of the cranes is limited. American exporters owe it to their customers to look carefully after these details, especially if the customer himself lays emphasis on the point, and they will find that attention to these matters will go

far toward retaining the good will and trade of a customer once obtained.

Third, beware of substitutions, they are the direct path to destruction. The needs of customers in South America are very often peculiar to their district, and substituted goods are in many cases altogether useless. When it is remembered that it may take a month to send the original order, another month to have the goods shipped, a third to complain of the substitution or to return the articles substituted, and a fourth to get the article originally ordered, it will be seen that one instance of this kind will be likely to impair the chances of the manufacturer concerned for an indefinite period. In the same class of actions is the sending of goods which do not correspond to the sample or the catalog description from which they were ordered. It is in nearly all cases a mistake to suppose that the manufacturer knows better what a customer wants than the customer himself, and this might be said to be particularly true in South and Central America, where most of the country is mountainous and transportation offers special problems, and where the preferences of the people have been accentuated by long use of one kind of goods. A firm that can be depended on to send the exact goods ordered will work at a big advantage in the Latin-American trade.

The fourth point squints at "smart" business, for which the real name is sharp practice. The granting of exclusive agencies and then the indiscriminate sale of products direct to all comers is an instance of unfairness that needs only to be mentioned to be condemned. There have been many complaints that exporting firms do not observe the terms of such arrangements, and have not only sold in the territory granted to an agency but have also terminated the agreement and entered the trade direct after the preliminary work and expense had been borne by the local firm. Practices of this kind are not conducive to the establishment of permanent trade relations. It often happens that an American firm offends in this respect while acting in perfect good faith. It grants an exclusive agency to a local concern in some country and then fills orders in the regular course of business from an export commission house that has customers in the same territory. Fairness to the local agent requires that this should be prevented, but the best method of procedure would probably be to have an understanding in regard to the matter before the agency is granted.

The fifth point concerns credit. For all exporters who are new to the field, or who are operating through salesmen or correspondence merely, it would probably be as well to continue to use caution in the granting of credits. Financial conditions in many South American countries are not on so sound a foundation as in the United States; and it often happens, besides, that beginners in business who have small knowledge of trade or of their particular line do not hesitate to lay in a large stock of goods on credit without regard to future contingencies. The credit-information facilities in some countries, such as Argentina and Uruguay, are said to be as good as in the United States, but the factors affecting business are perhaps more numerous than those in the United States, and different in character, and this makes the granting of long credits without a knowledge of the country more or less a leap in the dark. The whole credit situation is best handled by a permanent agency of the exporter that remains on the ground year after year and knows not only the varying phases of the economic situation but also the character and standing of the commercial firms to which it sells. Perhaps the best of all mediums for keeping in touch with the credit situation is the permanently established American branch house or agency, with Americans of experience in charge. A firm with such a representative can afford to grant credit terms to compete with those of Europe, and will probably find it advantageous to do so. But others would do well to go slowly, and at any rate to lay down a general policy of extending credit only after thoroughly satisfying themselves, from a study of the many elements involved, as to the lengths to which they would be justified in going.

SUMMARY OF REPORT OF LATIN-AMERICAN TRADE COMMITTEE

Appointed by the Secretary of Commerce Pursuant to Resolu- tion of the Informal Latin-American Trade Conference

The industries of the United States will be seriously injured by loss of Latin-American trade if the restriction of commercial credits is not remedied and that it is to be hoped banks will extend accommodations at least sufficient to assure maintenance of existing trade is one of the conclusions of the Latin-American Trade Committee appointed by Secretary of Commerce W. C. Redfield.

How dependence upon London banking saps American foreign selling power and how the sister republics are turning to the United States for funds to carry on industrial development are set forth in the committee's report which has been issued for the purpose of providing the public's intense interest with a businesslike analysis of present conditions and future prospects. The committee is headed by James A. Farrell, chairman of the National Foreign Trade Council, and consists of representatives of manufacturing, commercial, transportation and financial elements engaged in, or affected by, foreign trade. Of present conditions the report says:

"Since August 1 of this year the countries in South America whose currency is not already on a gold basis have experienced a serious depreciation of their paper money.

"The export of copper, tin, nitrates, coffee and other products has been curtailed because of loss of the normal European markets. As indicative of financial conditions, bank holidays and moratoria were declared at the outbreak of hostilities which were extended in certain countries from 60 to 90 days. The effect has been damaging to American exporters as, under such circumstances, drafts due in August will not be liquidated until November or December. This means a large accumulation of draft indebtedness never contemplated by the shipper. Specie payments were suspended."

The United States is confronted by the necessity of holding its normal export trade with Latin-America and by the possibility of increasing that trade by filling Latin-American needs for merchandise hitherto purchased in Europe, which Europe cannot now supply.

"Production in the United States can be maintained if there be a sufficient market at home and abroad for American goods. Production in South America may continue but cannot be further developed unless financial assistance be obtained.

"At the present time steamships are available to the principal ports of Latin-America and from those ports to the United States. Many of these vessels are unable to obtain full cargoes. Although only a limited number are under the United States flag the above will clearly indicate to exporters, importers and manufacturers that they need not hold back from entering the field on this account.

"Before trade can resume its normal course, the exchange problem must be solved, either by the restoration of old, or by establishment of new credit facilities."

The committee found that in contrast to the well balanced commerce of England and Germany, the Latin-American trade of the United States showed in the fiscal year of 1914 a balance of \$187,012,514 against this country.

"Our exports to, and imports from, Latin-America are shipped direct," says the committee, "but (almost exclusively in South American and largely in Central American trade) they are paid for in sterling bills of exchange.

"We have been obliged to settle this adverse balance of trade by remitting to England either gold or goods to meet interest charges on the South American debt and to pay for goods purchased in Europe by the South American countries . . .

"Deprived of the European loans with which their resources

were being developed, Latin-American countries are now undergoing a serious curtailment of industry and development.

"It has been increasingly the practice of European bankers to stipulate the use of European material in the projects which they financed. Latin-America is now turning to the United States for funds. This country is hardly in a position to undertake considerable investments at the present time, but industries with an already considerable trade at stake may well consider the necessity of protecting that trade by obtaining for their customers some relief from the present stringency. Such investments, if judiciously made, would yield an ultimate fair return and meanwhile provide a market for American materials which cannot now be sold.

"The question of creating a market for Latin-American securities in the United States, therefore, is highly important. The development of our trade with those countries is largely dependent on its satisfactory solution.

"Unless the restriction of commercial credits be remedied, however, we will not only be unable to extend our trade but we will lose a considerable portion of that which we already have.

"Whenever there is a great disturbance of the world's finances, American exporters and importers in South American trade are injured, because of their dependence on London. This has happened four times in 25 years.

"The maintenance of exchange relations depends on a credit machinery and reciprocal balances. This machinery will partially be provided under the Federal Reserve Act, which permits American banks to open branches abroad and permits a rediscount in this country of commercial paper, based on shipments of commodities in foreign trade."

The committee considered the proposed establishment of a "co-operative exchange" or merchant's clearing house for Latin-American trade. The plan was pronounced impracticable.

"Your committee feels that merchants and manufacturers now contemplating an entry into the Latin-American field should be careful to avail themselves of the easily accessible information concerning these markets. The cost of maintaining individual representatives would probably be too great for many of them to bear themselves. It is therefore suggested that associations consisting of the smaller firms or corporations engaged in kindred lines of production might be formed, and that either one or more representatives should be sent to South America to look after the interests of such associations, thereby bringing the cost of representation within a reasonable limit.

"Merchants and manufacturers should not attempt to install their own establishments in Latin-America unless they are prepared to meet initial losses and disappointments before realizing even moderate profits in what must necessarily be a developing, rather than a ready made, business.

"Your committee begs to state its belief that the present disorganization of the trade of the United States with Latin-America may best be remedied and placed on a permanently satisfactory basis by

"First—The establishment of a dollar exchange, through the ultimate creation of a discount market and pending the establishment of a discount market, by the extension of adequate accommodation by banking institutions, and the establishment of reciprocal balances in the United States and in Latin-America for financing Latin-American trade.

"Second—Perfection of our selling machinery by furnishing additional support to commission houses familiar with Latin-American business; by forming associations of merchants and manufacturers to be jointly represented in Latin-America, and by obtaining information as to the possibilities of developing retail stores in large Latin-American cities."

Silver is very quickly and nicely cleaned by boiling in an aluminum kettle, in a suds made with Ivory soap.

INTERESTING NEW AUTO MODELS OUT

Announcements Made of Eight, Six, and Four Cylinder Cars from \$495 to \$5,000

Specifications and announcements of a number of new models have interested the trade recently. Some of the new things promised and performed are as follows:

An eight-cylinder announced by the King Motor Car Co. at a price of less than \$1,500 complete. The car is to have 40-45 horsepower, but full mechanical details are not to be disclosed until December 10. The new car will be exhibited in coming automobile shows.

After cautious experimenting, covering a period of many months, the Willys-Overland Co. has announced the specifications of a six-cylinder Overland. The model is offered only in the single body design, and sells for \$1,475, electrically lighted and started, and completely equipped. Wheel base is 125 inches. With a bore of 3½ in. and a stroke of 5¼ in., the motor develops 45 or more horsepower at a normal engine speed. The cylinders are cast en bloc with the cylinder head detachable as a unit, exposing cylinders, pistons, valves, and valve chambers.

A new Stearns-Knight five-passenger touring car will sell for \$1,750, completely equipped. It is the first one in the world to sell with a Knight-type motor for less than \$2,000. It is a factory-built creation, guaranteed of 40 horsepower. There is a companion cabriolet for \$2,250 and limousines for \$2,850 up.

Philo E. Bemington, grandson of "the father of American gummaking," has brought out a light roadster to sell for \$495. The power plant is the unit type, including clutch and transmission; the motor has four cylinders, is water cooled, and is of the long-stroke type. The crank shaft is extremely large and the connecting rods are long, thus eliminating side thrust on the pistons. The gear set is of the selective sliding type, three speeds forward and reverse, with all gears of chrome nickel steel, and is operated by the Hollister automatic gear shift.

Announcement is made by R. E. Ingersoll, manager of eastern branches of the Reo Motor Car Co., of a coupe which has been added to the Reo line. This new job, which lists at \$1,575, is built on the standard chassis and the body is interchangeable with that of the roadster.

The Cole Standard Four, a seven-passenger four-cylinder model, 120-inch wheelbase, weighing about 3,000 pounds, to retail at \$1,485, nearly \$200 less than the previous four-cylinder model, is announced by the Cole Motor Car Co. The new four body is a stream line design, having neither rise nor drop in cowl. The Stewart-Warner vacuum gravity gasoline control system is used on all models. The four carries the 4¼ x 5¼ Northway unit power plant, giving the car a rating of 40 horsepower at 1,600 revolutions per minute.

Announcement has been made by officials of the Grant Motor Co., Findlay, O., of a new six-cylinder model to sell at \$795. The new six has a wheel base of 106 inches, and will carry full equipment, including electric lighting and starting apparatus. For purchasers who do not desire the electric lighting and starting system the price of the car will be \$750, including acetylene lights.

Finley R. Porter, formerly chief engineer of the Mercer Automobile Co., of Trenton, N. J., has organized the Finley Robertson Porter Co., and has taken over the plant of the Metropole Motor Car Co., at Port Jefferson, L. I., where he will produce a 100 horsepower, 140-inch wheel base chassis, to sell for \$5,000, with full electrical equipment. The motor has an A. L. A. M. rating of 34.2 horsepower, and will develop 171 horsepower. It is of the valve-in-the-head type with four 4.6 x 6.75 in. cylinders, a single overhead cam shaft operating all valves. The piston displacement is 449 cubic inches. The officers of the new company are: President, Mr. Porter; vice-

president, F. D. Veiller; second vice-president, H. Adams; secretary, C. H. Froelich; treasurer, R. B. Porter.

In response to the demand for a car of this type the Haynes Co. has announced a light six cabriolet. It may be converted from a roadster to a coupe or vice versa in less than a minute's time by a person within the car. When used as a roadster the plate glass windows are dropped into recesses in the doors and the curtains are kept in a carrying space built into the back of the seat.

FACTS CONCERNING BANNER-REGAL MERGER

J. D. Cathey, of the Regal Buggy Co., St. Louis, has given out the following statement:

"We have merged our business with the Russell E. Gardner factories, which include besides the big Banner Buggy Co. factory, several other plants. The writer has purchased a large interest in the consolidated companies, assuming those duties beginning October 1. I will be made first vice-president of the company and expect to assume an active part in the general management.

"The report has gone forth in some quarters that the Regal Buggy Co. has sold out, but the change is more in the nature of a merger. If the carriage trade wish an explanation for the change that has been made, I can say to you that the principal consideration was the fact that Mr. Gardner desired the services of the writer in the management of his various institutions, and the only way he could accomplish that purpose was by absorbing the Regal Buggy Co.

"The Regal Buggy Co. was incorporated October 10, 1906, therefore has been in existence eight years, during which time we have built up a splendid business all over the country, and has been a most successful institution. We have made money from the beginning, and it was with considerable regret that the writer finally agreed to the merging of our business with the Gardner institutions.

"It will be recalled that I was associated with Mr. Gardner in the Banner Buggy Co. for something over 15 years prior to 1906, having been with Mr. Gardner at the time the Banner Buggy Co. was organized and started in Columbus, O. The fact of the matter is I virtually grew up with Mr. Gardner, as I was connected with him in the spoke business before he ever attempted to make buggies. I first entered his employment as a boy, when he was manufacturing spokes for the old American Wheel Co., at Union City and Humboldt, Tenn.

"The addition of the Regal Buggy Co. plant to the Gardner institutions now gives us three large buggy factories, a wheel factory, a body and seat factory and a gear wood factory, all owned by the same company and under one management, and all of which are located in St. Louis. It gives us one of the most complete organizations in the United States devoted to the manufacture of horse-drawn vehicles, and with this prestige and equipment, we believe we will be able to give the trade better values than any other manufacturer in this line."

THE NEW DODGE CAR

The Dodge Bros. have finally announced the make-up of their new car. The price is set at \$785, and will be furnished only in five-passenger touring form.

The Dodge car is a streamline machine of sturdy mechanical construction. The specifications include a block-cast, L-head motor, 3⅞ x 4½ size; gearbox in unit with the engine; drive through a propeller shaft inclosed in a torsion tube to a floating rear axle; cone clutch; three-quarter elliptic rear springs; overslung frame, and left drive with center control.

The wheelbase is 110 inches, and tires 32 x 3½ all around, the rear set being of the non-skid variety. Equipment is of note in view of its completeness, taking in such items as North East combination motor-generator set for cranking and lighting, Eisemann magneto, Jones speedometer, one-man top, rain vision

and ventilating windshield to which the front of the top fastens, Willard battery, etc.

The body is a trim affair, being an example of all-steel construction. Even the frame is of steel. Upholstery is of machine and hand-buffed leather. The body and bonnet are united without any disturbing lines due to the consistent slope of both cowl and hood, which is finished out with a radiator of the coped-over edge type. The fender construction is good, being of the oval molded type rounding into the splashers.

The cowl board arrangement shows that the instruments necessary in driving are placed a little to the drive side of the center. To the right of them is a small compartment with a locker which may be used for carrying gloves, etc. The instrument panel is of pressed steel.

The motor, S. A. E. rating of 24, operates with a compression pressure of 65 pounds per square inch. There is no question that this motor is amply powerful for the car, for with a ratio of stroke to bore of 1.16, it has a displacement of 212.3 cubic inches. When the car is running at about 10 miles an hour on high, the motor is turning over at 380 revolutions per minute.

The general arrangement of the motor is of the type in which the cylinder head is a separate piece, bolting to the cylinders. The intake passages are cored through the single opening to the carburetor on the left side to the intake ports on the right, the cored passages being between cylinders Nos. 2 and 3. The exhaust manifold is a separate casting with an opening individually from each cylinder. A single long plate incloses the valve mechanisms.

On the left is mounted the motor-generator in addition to the carburetor, and the magneto and water pump are placed on the right.

The suspension of the motor is three-point.

NOW THE SHELDON AXLE AND SPRING CO.

In order to link together in its incorporate name both articles that go to make up the bulk of the Sheldon output, the name of the Sheldon Axle Co., Wilkes-Barre, Pa., has been changed to the Sheldon Axle and Spring Co.

The company recently completed a number of large additions. The entire axle assembly department has been moved into new quarters and complete equipment of new machinery has been installed in the vacated assembly room, which is devoted exclusively to the worm gear proposition.

In this connection announcement also is made by the company of the bringing out of a new 1,500-pound worm gear driven axle which is now ready for delivery in quantities. This now gives a standard line of Sheldon worm gear drive rear axles consisting of four sizes, namely 1,500 pound, one, two, and three ton.

The new size is identical in design with the previous sizes, using ball bearing throughout for both the radial and thrust loads in the worm itself.

THE KRATZER CATALOG

A better description cannot be given of the catalog just issued by the Kratzer Carriage Co., of Des Moines, Ia., than that contained in a letter to The Hub by President Walker of that company. He says:

"We are sending under separate cover our new catalog which has just been received from the printer and which we believe covers the specifications of what you consider a model carriage catalog given in your issue of The Hub of September, better than any catalog that has ever been printed.

"First, as to size, being 8¾ x 11 in., which is practically standard. It is a salesman inasmuch as it has selling talks on every page. It is not a freak—is well dressed, neat with attractive cover. It has good paper, printing and illustrations. It is exceedingly well written. Observe the opening attack on page 2. Observe the general descriptions beginning on page 58. It

gives all of the details as to measurements as you will notice by the description under each vehicle. It has a guaranty put up in an attractive manner, page 61. It is sent out with order blank and return enveloped. It has the proper shadow cuts showing details, pages 52 to 57, and we believe is a catalog that will attract attention."

TRADE NOTES

C. H. Gleason has joined the sales and designing force of the Kalamazoo (Mich.) Spring & Axle Co. Mr. Gleason has had many years' experience in manufacturing and designing all classes of vehicles, and during the past seven years has held a responsible position in the sales department of Sheldon Axle Co.

The parts department of the Woodward Carriage Co., at San Antonio, Tex., was deluged during a flood on October 23. It had been intended to remove the material to new quarters in 15 days, but the flood made immediate change necessary.

T. P. Moore has disposed of his interest in the Charlotte (N. C.) Wagon & Auto Co. to Messrs. O. V. Hoke and A. K. McLeod. Mr. Hoke will be actively engaged with F. A. Owens in the management. The Charlotte Wagon & Auto Co., which began business about two years ago, manufactures delivery wagons, automobile truck bodies and tops, and does general vehicle repairing and painting.

PARRY INNOVATION

Parry Mfg. Co., of Indianapolis, has produced a distinct innovation in the ironing of seat frames for buggy bodies. The basic idea is an angle iron used on each corner of the frame and extending from the sills to the seat, thus doing away with the perpendicular seat rods that have previously been used. The corners of each seat frame are further strengthened by the use of the Parry patented corner irons. This style of ironing is to be used by the company on all drivers, top buggies and Concords put out for 1915 trade.

GESTENSLAGER FACTORY BUSY

According to a local paper the Gestenslager Company, at Wooster, O., has more orders for vehicles on its books at the present time than a year ago and reports prospects bright for the future.

FILES BANKRUPTCY PETITION

The H. Abel Wagon Co. filed a voluntary petition in bankruptcy in the United States court at Birmingham, Ala. The case was referred to Judge E. H. Dryer, referee in bankruptcy, who appointed W. G. Estes as receiver to operate the business as a going concern.

PUBLISHER'S STATEMENT

Statement of the ownership, management, etc., of The Hub, published monthly at New York, N. Y., for October 1, 1914, as required by the Act of August 24, 1912.
 Editor, C. H. E. Redding, 24 Murray St., New York City.
 Managing Editor, C. H. E. Redding, 24 Murray St., New York City.
 Business Manager, G. A. Tanner, 24 Murray St., New York City.
 Publisher, Trade News Publishing Co., 24 Murray St., New York City.
 Owners: (If a corporation, give its name and the names and addresses of stockholders holding 1 per cent. or more of total amount of stock. If not a corporation, give names and addresses of individual owners.)
 Trade News Publishing Co., 24 Murray St., New York City.
 Joseph H. Wright, Toms River, New Jersey.
 G. A. Tanner, 24 Murray St., New York City.
 Geo. W. Hills, Fairfield, Conn.
 Known bondholders, mortgagees, and other security holders, holding 1 per cent. or more of total amount of bonds, mortgages, or other securities: None.

TRADE NEWS PUBLISHING CO.

G. A. Tanner, Business Manager.
 Sworn to and subscribed before me this 5th day of October, 1914.
 JOSEPH R. FRITH,
 Notary Public Kings County. Commission expires March 30, 1916.

O B I T U A R Y

F. A. Brown, about 58 years old, and who had been in the employ of the Mifflinburg (Pa.) Buggy Co. for five years covering the New England territory, dropped dead just as he was alighting from a train at Poughkeepsie, N. Y., on October 15. The funeral services were held at his home in Hudson, October 18, and burial was made at Kinderhook, his old home. Mr. Brown was an unusually large man, weighing about 300 pounds, and was extremely active. Hard working, conscientious and loyal, he was well liked among his trade and was a man who had lots of friends.

Walter L. Crossman, for over 20 years traveling representative of Beckwith-Chandler Varnish Co., was found dead in his room in a Cincinnati hotel on October 20. The indications were that he had been stricken the previous night while preparing to retire. He had complained on various occasions of slight heart trouble but did not regard it seriously. He resided in Buffalo and leaves a widow and two children. Mr. Crossman spent his boyhood days at Sennet, Cayuga county, N. Y. When he was 18 he went to Skeneateles, N. Y., to take his first lesson in the carriage painting trade. After three years he went to Bath, N. Y., and from there he went to Owego, where he remained for about five years. He then removed to Syracuse, N. Y., in the employ of H. A. Moyer; resigning to accept the position of superintendent of painting department with O. H. Short & Co., Syracuse, which position he held until he was engaged by the Beckwith-Chandler Company in 1892 as traveling salesman, his first work outside of the shop. Mr. Crossman, during the long period he was employed by Beckwith-Chandler Company, covered a large territory, and for some years it had been his custom to make an annual visit to the Pacific coast; so his sudden death will find among his wide list of friends an expression of profound sorrow and sympathy. Mr. Crossman was, up to the time of his death, rugged and robust. He was thoroughly conscientious in his labors and took an unusual degree of pride in fulfilling every obligation.

John D. McIntosh, vice-president of the Munro & McIntosh Carriage Co., Ltd., of Canada, died recently. He was 56 years old.

Frederick Wells Parrott, a well known resident of Bridgeport, Conn., died suddenly last month at his home at 51 Milne street. Though he had been suffering for some time past with pulmonary troubles, he was out of doors on the day of his death. Mr. Parrott was born in Bridgeport, Conn., on July 17, 1855, and was educated in Norwalk. He was a son of Henry R. Parrott, of Bridgeport. In 1875 Mr. Parrott became connected with the Parrott Varnish Co., of that city, of which his father is president, and since 1891 he has been secretary and treasurer of the company.

James W. Rogers died October 26, at his home in Cleveland, O. For 35 years he conducted a carriage and wagon works at 2400 Broadview road S. W. Mr. Rogers is survived by three children.

William M. Stiles, superintendent of the varnish factory of Edward Smith & Co., Long Island City, N. Y., died at his home October 15, after a short illness. He had been in charge of the factory since 1897, and was previously with the H. W. Johns Mfg. Co., and before that was with the Johnston Paint Co., of Montreal.

FIRES

Fire did about \$2,000 damage to the carriage and wagon plant of Rhein Bros., at Baltimore, Md., October 23.

The plant of the Bender Wagon Co., Texarkana, Tex., was destroyed by fire on November 5. Loss estimated at from \$8,000 to \$10,000 and insured at about one-third that amount.

INDEX TO ADVERTISERS

Baltimore Hub-Wheel and Mfg. Co.....	40
Backstay Machine and Leather Co.....	38
Buckeye Paint & Varnish Co.....	40
Central Mfg. Co.....	40
Columbus Bolt Works.....	4th cover
Correspondence School of Carriage and Motor Drafting...	2
Cumberland Hotel.....	3d cover
Dowler, Chas. L.....	40
Eccles, Richard, Co.....	3
Fairfield Rubber Co.....	3
Gifford, John A., & Son.....	3
Jones & Co., Phineas.....	3d cover
Keystone Paint & Filler Co.....	3
Lawson Co., F. H., The.....	2d cover
Masury, John W., & Son.....	2d cover
Miller Bros.	40
Mulholland Co., The.....	40
National Spring & Wire Co.....	2d cover
Payne Co., E. Scott.....	40
Pierce, F. O., Co.....	3d cover
Porter, H. K.....	3
Sheldon Axle and Spring Co.....	3
Sherwin-Williams Co., The.....	1
Sidney Mfg. Co., The.....	40
Standard Oil Cloth Co.....	4
Stewart-Mowry Co.....	4th cover
Technical School for Carriage Draftsmen and Mechanics..	38
Virginia and North Carolina Wheel Co.....	4th cover
West Tire Setter Co.....	3d cover
White-Quehl Mfg. Co.....	40
Wilcox Mfg. Co., D.....	1
Willey Co., C. A.....	2

NEW FORD TIRE CO. WILL LOCATE IN FINDLAY

The Toledo-Ford Tire Co. will locate in Findlay, O., and expects to begin operations about the first of the year. The company will be capitalized at \$300,000 and sell tires direct to the user. The Findlay factory will make tires in two sizes only and specialize on Ford automobile tires, reducing the cost very materially. They will sell, it is announced, 25 per cent. below the ordinary cost and save to the user about \$19 per set.

W A N T S

Help and situation wanted advertisements, 1 cent a word; all other advertisements in this department, 5 cents a word; initials and figures count as words. Minimum price, 30 cents for each advertisement.

PATENTS

Patents—H. W. T. Jenner, patent attorney and mechanical expert, 606 F St., Washington, D. C. Established 1883. I make a free examination and report if a patent can be had and exactly what it will cost. Send for circular.

SITUATIONS WANTED

Situation wanted as carriage painter, by an all round man in paint shop; wishes job in small custom shop in country town. Box 29, care The Hub, 24 Murray street, New York.

Wanted—Position as sales manager or salesman; 18 years active experience; familiar with credits and every detail of vehicle business. Chas. H. Kelly, care Studebaker Bros. Co., 445 Broadway, New York City.

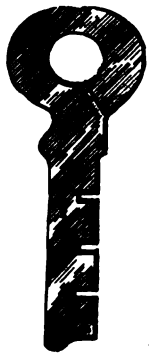

To Satisfaction on Welts and Gimps
A CUSTOMER ONCE—CUSTOMER ALWAYS

Backstay Machine and Leather Company

UNION CITY, INDIANA



"Self-Propelled Vehicles"

Fifth Edition, Revised.

A practical treatise on the theory, construction, operation, care and management of all kinds of Automobiles.

By

JAMES E. HOMANS, A.M.

Contains 608 pages and upwards of 500 illustrations and diagrams, giving the essential details of construction and many important points on the successful operation of the various types of motor carriages driven by steam, gasoline and electricity.

This work is now the accepted standard, explaining the principles of construction and operation in a clear and helpful way. This book will be sent postpaid to any address in the United States, Mexico or Canada upon receipt of \$2.00.

Address

Trade News Publishing Co.

24 Murray Street, New York

Carriage Mechanics

Desiring to improve their present Condition should attend the

TECHNICAL SCHOOL

FOR

Carriage Draftsmen and Mechanics

SUPPORTED BY THE

Carriage Builders' National Ass'n

The object of the School is to teach men to design vehicles and make working drawings, and to otherwise facilitate their work in the shop. Only those men employed in carriage or automobile building or their accessory trades are admitted to its privileges.

The classes are conducted in three divisions, viz.: Corresponding, Day, and Evening. The former is open during the entire year, while the day and evening classes are in session only from October 1 to April 1.

The tuition is moderate.

For prospectus and full particulars, write to the instructor,

ANDREW F. JOHNSON,

20 West Forty-fourth St.,

NEW YORK CITY

Subscribe
Now for

THE HUB

\$2.00
Per Year

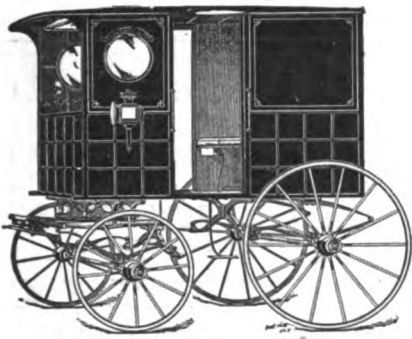

No. 112.—Milk Wagon.

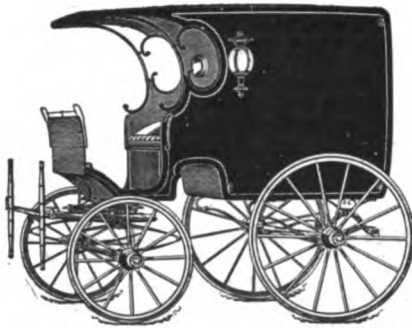

No. 111.—Altman Wagon.



No. 113.—Grocery Wagon.

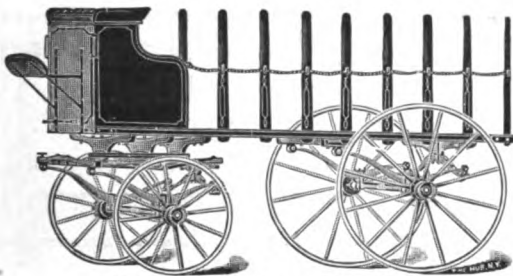

No. 122.—Flour Truck.

Electrotypes

of the vehicles presented on this page will be forwarded on receipt of

75 cts.

for each cut, to any address. Postage prepaid.

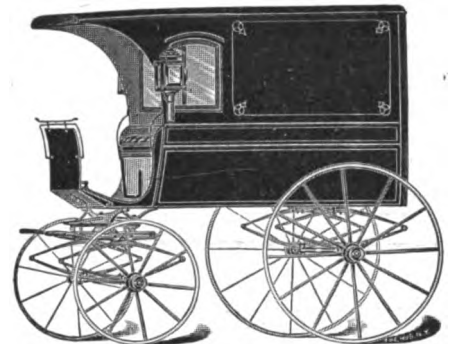

No. 115.—Delivery Wagon.

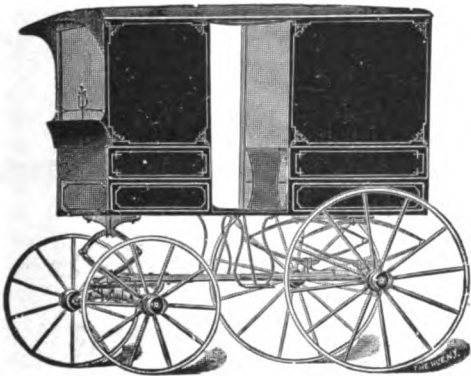

No. 116.—Milk Wagon.

Catalogue

containing nearly 200 illustrations of carriages, wagons, sleighs, and miscellaneous cuts will be sent upon application.

Trade News Publishing Co.
24-26 MURRAY ST.
NEW YORK

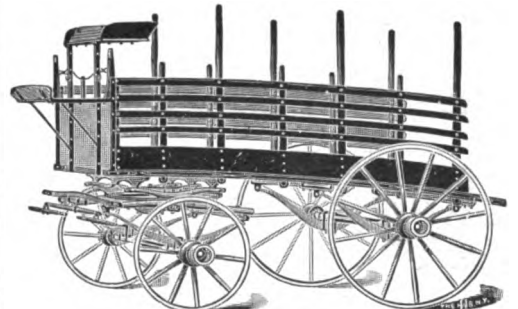

No. 117.—Merchandise Truck.



No. 114.—Delivery Wagon.

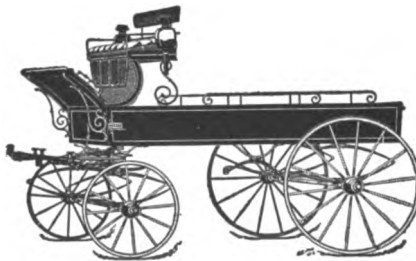

No. 124.—Delivery Wagon.



No. 118.—Ambulance.

BUSY BUYERS BRIEFS

Baltimore Hub-Wheel & Mfg. Company
Manufacturers of
Wheels AUTO MOTOR CAR CARRIAGE WAGON
Also SPOKES and RIMS
Factory: Harford Ave. and B. & O. R. R.
BALTIMORE MD.

CHARLES L. DOWLER
CARRIAGE AND WAGON HARDWARE
108 North Third St., Philadelphia, Pa.
CUSHION MANUFACTURER
Pure Stearic Acid Candles. Wheel Stock. Snow
Flake Axle Grease.

BUCKEYE PAINT & VARNISH CO.
Manufacturers of
Automobile and Carriage Paints
TOLEDO, OHIO

MULHOLLAND BUGGY SPRING
Reduces weight of springs one-half.
Made in one size only but will fit bodies
of all widths.
Write for further particulars and prices.
THE MULHOLLAND CO. DUNKIRK, N. Y.

 **White's Brazing Sleeves**
For applying Rubber Tires
Send for Samples.
LINED
 **WHITE-QUEHL MFG. CO.**
431 E. Pearl St.
CINCINNATI, OHIO
UNLINED

STEEL SEATS AND BODIES
Not a Weld, Joint or Seam
CENTRAL MANUFACTURING CO.
CONNERSVILLE, IND.

AUTOMOBILE BODIES AND CARRIAGES
IN THE WHITE
Estimates Furnished on Special Designs
MILLER BROTHERS
Amesbury, Mass.

E. SCOTT PAYNE CO.
Carriage and Automobile
HARDWARE
Horse - Shoers' Supplies
362-364 North Gay St., Baltimore, Md.

**Sidney Metal Buggy Seats
and Metal Bodies**
The Best in the World
Every Seat Guaranteed
THE SIDNEY MANUFACTURING CO., SIDNEY, O.

Results always follow
advertising in
THE HUB

It Pays
Others
It Should
Pay You

"TRIUNE" COLOR VARNISH

Is strictly a Varnish Product possessing color with the power to Cover in one Coat. It works as freely as straight varnish and will "flow," "level," "rub," "moss" and exhibit in general full durable qualities and working properties.

THREE QUALITIES IN ONE PRODUCT

1—Color. 2—Power to cover in one coat. 3—Straight varnish working properties and qualities. Nothing like enamel or gloss paints. Different, distinct.

Sole Manufacturers

F. O. Pierce Company, New York City

12 West Broadway

HOTEL CUMBERLAND

NEW YORK

BROADWAY AT 54TH STREET

Near 50th St. Subway Station and 53d St. Elevated.

"Broadway" cars from Grand Central Depot pass the door, also 7th Avenue cars from Pennsylvania Station.

New and Fireproof

Best Hotel Accommodations in New York at Reasonable Rates.

\$2.50 with bath and up

European Plan

All Hardwood Floors and Oriental Rugs

Ten minutes' walk to 40 Theatres

Excellent Restaurant
Prices moderate

Send for Booklet



HARRY P. STIMSON, Formerly with Hotel Imperial

Only New York Hotel window-screened throughout

1855—Standard for 59 Years—1914

Jones Wheels

"Best on Earth"

The Name of Jones as Applied to Wheels Means the
First, Last and All-the-Time Word in Wheels

"Kantsamore"

Buyers of vehicles should say, "Give me wheels made by

Phineas Jones & Co.

NEWARK

NEW JERSEY

U. S. A.

The WEST Hydraulic Tire Setter

WILL CUT DOWN EXPENSE



Tires set cold in one minute. This machine saves time—does the work better and quicker, does away with burned streaks. Only necessary to measure one wheel in a lot. Does not char the rim, and thus make the tire loosen prematurely.

Saves resandpapering of wheels. This machine is now increasing the profits of many manufacturers. Send for catalog and read about it.

WEST TIRE SETTER CO.,

ROCHESTER, NEW YORK

BENT RIMS Hickory Second Growth and Forest Hickory
All Grades

OAK—STAR BRAND

SPOKES Second Growth Hickory—Finished and Club Head
SUITABLE FOR ALL VEHICLES, INCLUDING AUTOMOBILES

VIRGINIA AND NORTH CAROLINA WHEEL CO.

8 Bridge Street, New York City

RICHMOND, VIRGINIA

THIS TRADE MARK MEANS MUCH TO VARNISH USERS

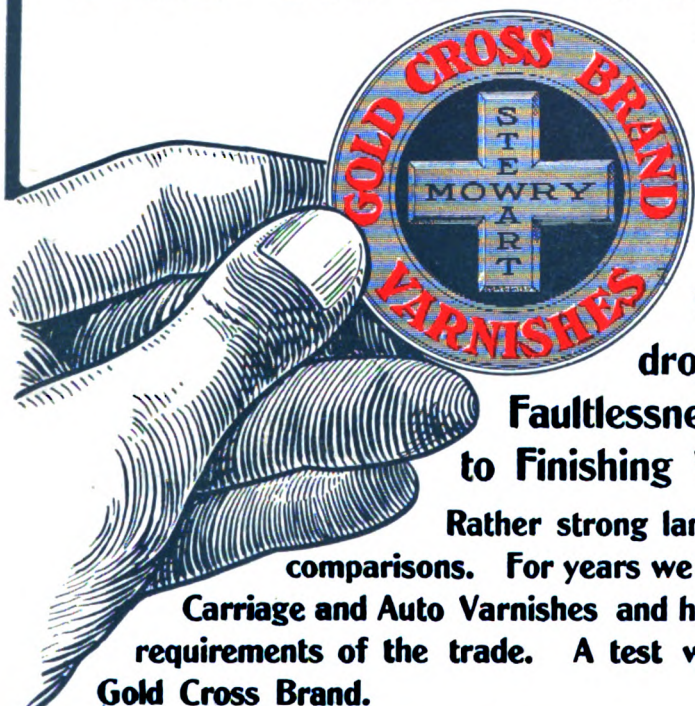

It signifies Quality. It is placed only on the best line of Varnishes we make—our Gold Cross Line.

We stake our reputation on every drop that bears this brand. It implies Faultlessness, and has no superior from Japan to Finishing Varnish.

Rather strong language—but we can prove it; and we court comparisons. For years we have been making the most complete line of Carriage and Auto Varnishes and have put some very intensive study into the requirements of the trade. A test will convince you of the superiority of the Gold Cross Brand.

STEWART-MOWRY CO., CHICAGO, ILL.

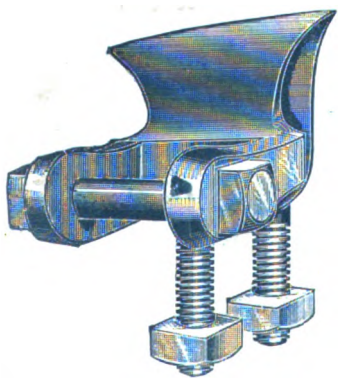

Skewed Shaft Couplings

**Regular or Oval Patterns
For High Arched Axles**

Furnished in rights and lefts for any height of arch. Oval Axle Clips $\frac{5}{8}$ or $\frac{3}{4}$ width to match Oval Couplings. Bolts, Clips, Couplings, Carriage Hardware and Special Forgings

Catalogue "H" and Prices on Application

COLUMBUS BOLT WORKS, Columbus, O.

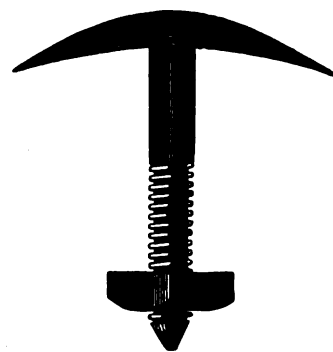

The Hub



TRADE NEWS PUBLISHING COMPANY

24-26 MURRAY ST. NEW YORK

"BLACK VELVET" CUSHION SPRINGS

Manufactured Only by the

NATIONAL SPRING AND WIRE COMPANY

ALBION, MICH. WINDSOR, ONT.

THE SPRING OF QUALITY.

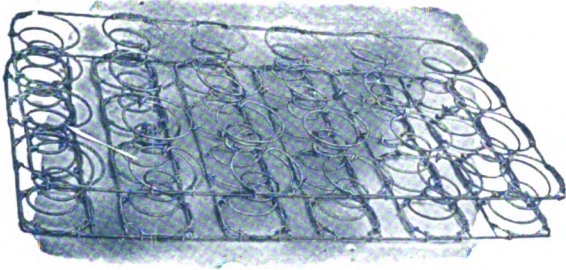

SPRING or SOFT EDGE CUSHION FRAME
For Buggies or Other Vehicles. Built of the Highest
Grade of Steel Wire.

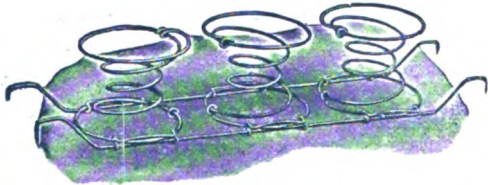

STRIP FOR WOOD OR BOX FRAME

THE F. H. LAWSON CO.

CINCINNATI, O.

Manufacturers of

Metal Buggy Seats

FLEUR DE LIS PATTERN

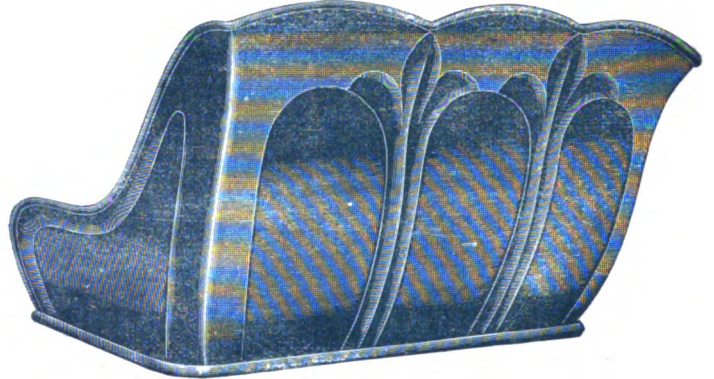

NEW STYLES—ALL SIZES

STRONGEST—NEATEST—BEST

No Solder Used

YOUR VEHICLE SELLS WHEN EQUIPPED WITH

LAWSON'S METAL SEATS

Write for Prices

JOHN W. MASURY & SON

Originators of

Superfine Coach and Automobile Colors

Acknowledged the Standard for Fifty Years

AND MANUFACTURERS OF

Fine Carriage and Automobile Varnishes

New York,

Chicago,

Minneapolis,

Kansas City

SHELDON AXLES AND SPRINGS

**For Horse-Drawn and Power-Propelled
Vehicles of All Kinds**

JUST ENOUGH BETTER THAN OTHERS TO BE NOTICEABLE

When you specify "Sheldon" you are not experimenting with experiments, but are getting Axles and Springs with years of manufacturing experience back of them—Axles and Springs that are selected for important work where conditions make reliability supremely important

SHELDON AXLE AND SPRING COMPANY, WILKES-BARRE, PA.

LARGEST AXLE AND SPRING FACTORY IN THE WORLD

WILCOX FINE FINISHED FORGED

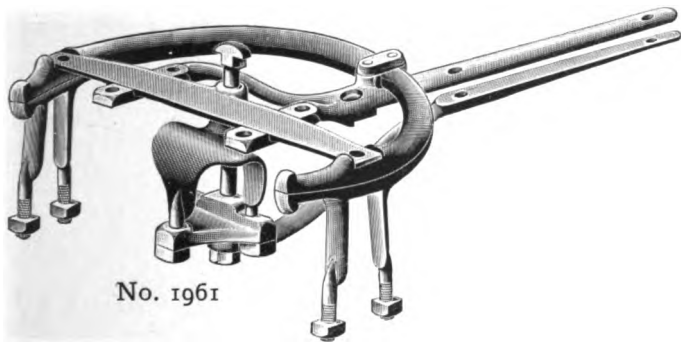

No. 1961

**Carriage Hardware
and Gear Irons**

Write us for Catalogue No. 11B

The D. Wilcox Mfg. Co.

MECHANICSBURG,
CUMB. CO., PA.

WILLEY'S COLORS

The **RECOGNIZED STANDARD**



C. A. WILLEY CO.

COLOR GRINDERS

and Manufacturers of Specialties in

CARRIAGE, AUTOMOBILE AND CAR

PAINTS

COLORS, VARNISHES, ETC.

HUNTER'S POINT, NEW YORK CITY

The WEST Hydraulic Tire Setter WILL CUT DOWN EXPENSE

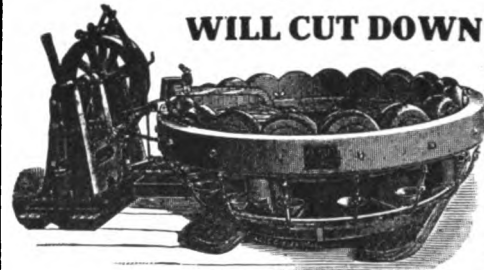

Tires set cold in one minute. This machine saves time—does the work better and quicker, does away with burned streaks. Only necessary to measure one wheel in a lot. Does not char the rim, and thus make the tire loosen prematurely.

Saves resandpapering of wheels. This machine is now increasing the profits of many manufacturers. Send for catalog and read about it.

WEST TIRE SETTER CO., ROCHESTER, NEW YORK

Established 1886

Correspondence School of Carriage and Motor Carriage Drafting

A thorough, practical tuition is given through this correspondence school. The theory and practice of construction, bookkeeping, perspective. Many men now hold good positions through taking the courses of instruction.

Principal, **THOS. MATTISON,**
Hillside Avenue, Bitterne Park,
Southampton, England

Author of "The Coach Body Makers' Guide," \$3.00; a practical treatise on "The Suspension of Carriages," "Bookkeeping," and other carriage building works.

WHAT IT IS

The American Harness and Saddlery Directory The 1914 Edition

An extra painstaking revision of the names (and other information as below) constituting the Retail Harness Trade, has been completed for this year's issue of the Directory, and we think the work is so important and worthy that the

1914 Price is \$5 Per Copy

and it is very moderate for what is offered in a work that is

Indispensable for Reference

for copying of addresses, and for all purposes usual in a directory.

Just a Sketch of Its Contents

The list of the **WHOLESALE** and **JOBGING TRADE** is so arranged as to make it convenient to separate the association members from those not so recognized.

The **RETAIL HARNESS MAKERS** of the United States and Canada comprise the principal part of the Directory, arranged by State, Town and County, and in the large cities, the street and number is given. Those rating (approximately) over \$1,000 are marked.

A list of **HARNESS DEALERS** as distinguished from retail harness manufacturers, is also given. The value of this list to those who solicit the vehicle, implement, hardware and department stores will be readily appreciated.

A list is also published of Export Commission Merchants, giving the class of merchandise they handle.

PUBLISHED BY

THE TRADE NEWS PUBLISHING COMPANY

PUBLISHERS OF "HARNESS"

24-26 MURRAY ST., NEW YORK

PORTER'S BOLT CLIPPERS
 "Easy" "New Easy" Allen-Randall



To Cut 5-16, 3-8, 1-2, 5-8, 3-4 Inch.

H. K. PORTER, EVERETT, MASS.

CARRIAGE—WAGON—AUTOMOBILE
 AND SPECIAL
DROP FORGINGS
 QUALITY—THE
 BEST

Richard Eccles Co., Auburn, N. Y.

PROMPT SERVICE.
 WRITE FOR CATALOG.
 SEND BLUE-PRINTS OR MODELS
 FOR OUR QUOTATIONS—IT WILL PAY YOU!



THE FAIRFIELD RUBBER COMPANY

Manufacturers of

**Carriage Cloth, Imitation Leather,
 Automobile Cloths, etc.**

FAIRFIELD, CONNECTICUT

KEYSTONE BLACK FILLER
 MAKES A PERFECT
ROUGHSTUFF
 For Automobile Bodies and Parts

It fills the pores of Metal and Wood perfectly. Sandpapers easily and produces a fine, smooth surface that DOES NOT CRACK, SCALE NOR PEEL.

POMEROY & FISCHER, New York
 Selling Agents to Vehicle Trade

KEYSTONE PAINT AND FILLER CO., Muncy, Pa.

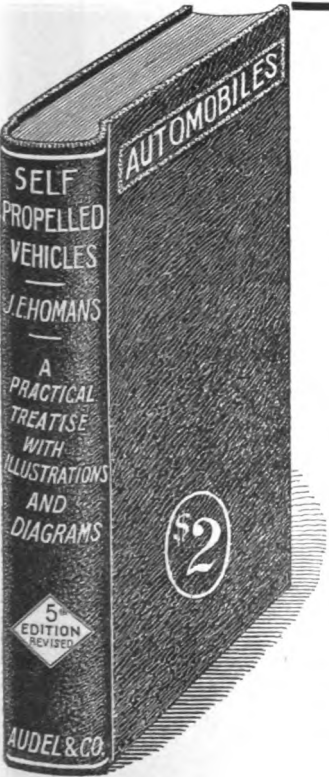

"Self-Propelled Vehicles"

Fifth Edition, Revised.

A practical treatise on the theory, construction, operation, care and management of all kinds of Automobiles.

By
JAMES E. HOMANS, A.M.

Contains 608 pages and upwards of 500 illustrations and diagrams, giving the essential details of construction and many important points on the successful operation of the various types of motor carriages driven by steam, gasoline and electricity.

This work is now the accepted standard, explaining the principles of construction and operation in a clear and helpful way. This book will be sent postpaid to any address in the United States, Mexico or Canada upon receipt of \$2.00.

Address

Trade News Publishing Co.
 24 Murray Street, New York

Carriage Mechanics

Desiring to improve their present Condition should attend the

TECHNICAL SCHOOL

FOR

Carriage Draftsmen and Mechanics

SUPPORTED BY THE

Carriage Builders' National Ass'n

The object of the School is to teach men to design vehicles and make working drawings, and to otherwise facilitate their work in the shop. Only those men employed in carriage or automobile building or their accessory trades are admitted to its privileges.

The classes are conducted in three divisions, viz.: Corresponding, Day, and Evening. The former is open during the entire year, while the day and evening classes are in session only from October 1 to April 1.

The tuition is moderate.

For prospectus and full particulars, write to the instructor,
ANDREW F. JOHNSON,
 20 West Forty-fourth St.,
NEW YORK CITY

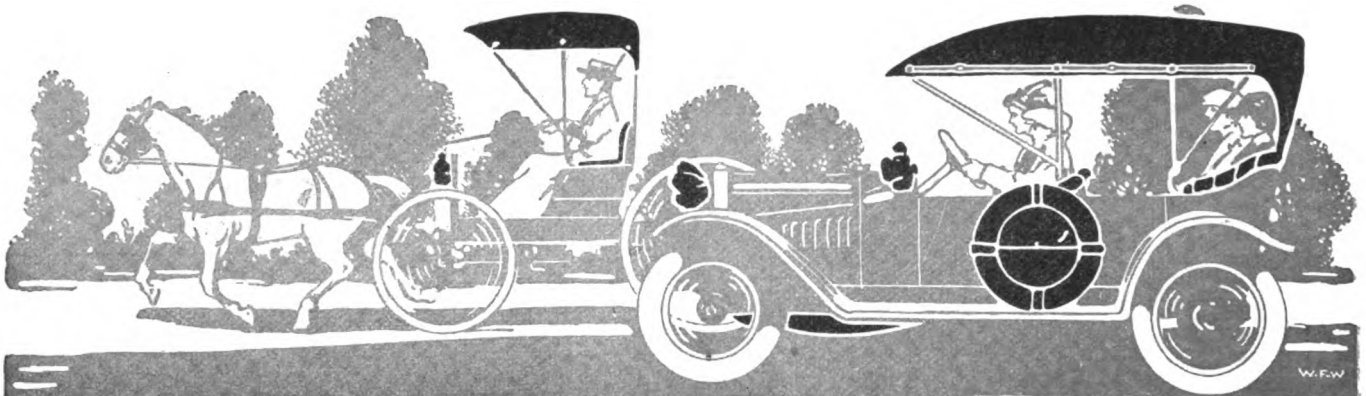

Learn More About The Leading Leather Substitute

Every carriage and automobile manufacturer—every manufacturer of carriage and auto accessories, storm curtains, aprons, lamp covers, tire cases, trunks, etc., should get and examine samples of

MERITAS

LEATHER CLOTH

Only by seeing the goods—by testing them—by noting the handsome, durable, non-cracking finish and the fine line of colors can you appreciate the high quality we have attained in the manufacture of a serviceable leather substitute.

There are styles, colors and finishes in MERITAS LEATHER CLOTH suitable for every carriage and auto trimming and upholstery purpose.

It can be had in muslin, duck and drill; dull or glazed; smooth or grained; in black and colors.

Sample book on request—write now and know more about the leading leather substitute.

Write
for
sample
book of
MERITAS
LEATHER CLOTH
NOW

The Standard Oil Cloth Co., Inc.

320 Broadway, New York

The Hub

Copyright, 1914, by the Trade News Publishing Co., of New York

Entered in the New York Post Office as Second-class Matter

Vol. LVI

DECEMBER, 1914

No. 9

THE TRADE NEWS PUBLISHING CO. OF N. Y. Publishers of THE HUB

J. H. WRIGHT, President

G. A. TANNER, Secretary and Treasurer

24-26 MURRAY STREET, NEW YORK

Other Publications of Trade News Publishing Co.:

HARNESS (monthly).....per year, \$1.00
AMERICAN HARNESS AND SADDLERY
DIRECTORY (annual).....per copy, \$5.00

THE HUB is published monthly in the interest of employers and workmen connected with the manufacture of Carriages, Wagons, Sleighs, Automobiles and the Accessory trades, and also in the interest of Dealers.

Subscription price for the United States, Mexico, Cuba, Porto Rico, Guam the Philippines, and the Hawaiian Islands, \$1.00, Canada, \$2.50, payable strictly in advance. Single copies, 25 cents. Remittances at risk of subscriber, unless by registered letter, or by draft, check, express or post-office order, payable to the order of THE TRADE NEWS PUBLISHING CO.

For advertising rates, apply to the Publishers. Advertisements must be acceptable in every respect. Copy for new advertisements must be received by the 25th of the preceding month, and requests to alter or discontinue advertisements must be received before the 12th day of the preceding month to insure attention in the following number. All communications must be accompanied by the full name and address of writer.

FOREIGN REPRESENTATIVES:

FRANCE—L. Dupont, publisher of *Le Guide des Carrossiers*, 78 Rue Boissiere, Paris. Subscription price, 15 francs, postpaid.

GERMANY—Gustave Mieser, Bohn a Rh. Subscription price, 12 marks, postpaid.

ENGLAND—Thomas Mattison, "Floriana," Hillside avenue, Bitterne Park Southampton. Subscription price, 12 shillings, postpaid.

Entered in the New York Post Office as Second-class Matter

Decline in British Trade

The British Board of Trade figures continue to show a natural effect of the war. The imports in November decreased \$62,400,000 and the exports decreased \$100,770,000. While the imports of food showed an increase of \$25,000,000, there was a decrease in the importation of cotton from America to the amount of \$32,500,000, and a decrease in the Egyptian product of \$10,000,000. All other raw material has also declined.

The principal shrinkage in exports were \$25,000,000 in cotton and yarns and \$10,000,000 in coal.

Where the Electric Scores

It is reported that a leading British engineering firm has acquired the agency for an American electric truck. There have been no electric commercial vehicles in London for many years, but as this type of vehicle is not apt to be commandeered for military purposes it will no doubt score heavily with the heads of traffic departments in England while the war is on.

You Are If You Are

If your name is not in the directory at the entrance of the building, not printed on the firm's stationery, and at the same time your brain and courage are directing the affairs of the company, you are in reality its manager and director.

No decision of a committee, no painted sign, no gold lettering on the door ever can give or deny you anything that is really yours. What difference does it make whose name appears on the stationery? The only thing that matters is the future—the opportunity to develop personal power, dignity and character, that neither man, type, ink, nor time can destroy.

If you are perturbed and vexed over your standing and position, the size of type in which your name appears—remember some day when the wind is east, when you are quibbling and wrangling over things that do not really matter, and never can—someone, somewhere, who is at work—improving his mind, taking inventory of his moral and mental stock—will soon pass you along the trail.

You never can be manager of anything or anybody by simply saying so—or by being appointed so. You never can be manager of a department or a business by being elected manager—you must be it. You are if you are, and if you are not, if you do not measure up to your position, no directors' meeting, no change in the company's letter-head can alter the fact that you have failed.

I know Fame and Wealth are magic words, but look back through the history you have read—down the list of names of noted men and women you have known—and, unless there was something substantial back of their dreams and ideals, what they really found after they had closed their hands over the rainbow of their fancy was an empty nothing—filled with unfounded hopes.

You cannot acquire position, fame, character and happiness by pursuing these things in themselves, but if you apply yourself to accomplish a certain thing because it is your life's work to accomplish it, your work will be followed by the success it deserves.

A boy with neither education nor experience—working for a salary of \$8 a week—can set up your name in 36-point type, but only a few men in a generation set up the physical, moral and mental monument that makes the MAN.

—"Everyman."

Foreign Trade Development

At Binghamton, N. Y., November 15, V. Gonzales, Foreign Trade Adviser of the National Association of Manufacturers, addressed the Men's Forum of the First Congregational Church on the effects of the war on the world's commerce and the necessity of pushing vigorously our exports.

"The war," he said, "has caused a universal calamity, and wherever we turn our eyes see misery and fear. But we are not going to overcome difficulties arising from this situation by sitting down and weeping over it. We must do something to keep moving our trade and that of the rest of the world still available. Hysterical papers have exaggerated the so-called 'opportunities' falling on this country because of the inability of the European industrial countries to supply the world with articles of consumption. I have never tried to find such opportunities because it is not a matter of opportunity at all. It is a calamity of which no one can take advantage, and if we are spared to a certain extent in the conflagration, the least thing we should think of is of taking advantage of the distress in which other countries are placed. We do not need to take any such advantage either; the trade will come to us by itself if we will do the right things at the proper time. 'Seizing,' 'capturing' or 'conquering' the trade are nonsensical words. Trade is neither 'seized' nor 'captured' nor 'conquered' because it is not taken away from anybody as it does not belong to any one country nor to any one man. 'Seizure,' 'capture' or 'conquest' means the victory over a resisting force, and the least thing we could ever expect is to trade by force with any one. We shall trade with other countries, as we have been doing for years; we shall increase our sales to them if we can supply what they need and if they are able to buy. We must not lose sight of the fact that the European markets closed to the sale of manufactures are also closed to the purchase of products of the countries to which they sold and that the foreign purchasing power of every country rises or falls in proportion to the increase or decrease of its exports. On this account the purchasing power of every country has shrunk, and we cannot expect to sell more to any one unless we can assist it in disposing of its products.

"For us the problem is one of vital importance. Because of our immense industrial machinery, we can not but keep moving; we must sell our manufactures or stop even if only in part our activity.

"Then we must export goods. We still need a tremendous amount of money abroad to take care of our foreign obligations and to pay for our imports, as we do not and can not produce all we need for our own consumption. The war has deprived us of buyers of our goods for a very large amount, perhaps 800 million dollars per annum, and we shall either have to store goods for this amount, which is not convenient to us, or not produce them, which is perhaps worse. Our exports amounted to 2,500 million dollars per annum, and to produce those goods there were employed no less than 2,000,000 men and consumed no less than one billion dollars worth of our own raw materials.

"The loss of one-third of the trade will cause the loss of work for 600,000 to 700,000 people, and fall in domestic production of 300 to 400 million dollars. If the cotton crop, worth about 800 million dollars, is a cause of so much concern to us, how should we look at the export trade, worth three times as much?

"But we are not going to improve conditions and replace our loss by selling goods to other countries if we let somebody else do it for us. We must act, and act promptly, and our action should be far reaching in its effects.

"Shipping, banking and credit, which are the three principal factors in foreign trade, are all three disturbed to a disastrous extent. Formerly we did not take care of any of the three—we shipped in foreign ships, we banked through foreign banks and credit was practically out of the question for us. We must

provide the three, and we can do it, as we have all the resources needed to create and extend these facilities. Of course, to provide for them we need the co-operation of all elements—manufacturers, brokers, merchants, ship owners, the government, and even individual activity.

"We must, as a matter of duty and convenience, assist all countries at peace in disposing of their products, as distributor and banker. We must help them with credit—both ways—to sell and to buy. We do not need any money for this, as no country needs money from without now, and they all need goods, which we have and can supply, and we can with our goods finance their needs and profit by it. But goods are not sold automatically nor are they moved by themselves, nor do the people of other countries know where to procure them nor whom they should ask for them. We must then employ individual efforts to acquaint those people with what we have and sell it to them, meeting their requirements under present circumstances.

"If we do this, and if we succeed in keeping the world moving during the conflict, we shall gain—not conquer, nor seize, nor capture—the position we shall be entitled to as the world's center for commerce and finance, not because we take it away from any one, but because it would be the natural outcome of the events for which we are not responsible."

NOT DEAD

Here is an item from the Nebraska Farm Journal which makes amusing reading: The man who believes that automobiles are driving the buggy and road horse out of the country, ought to have been in town at the band concert last Saturday night. The glistening of new buggies could be seen all around the square. Dealers are selling them by the carload. The boys declare a motor is no good to go to see a girl with. It costs too much; it stops when it should not; sometimes it makes too much noise, and the folks know just when you drive up to the girl's home. So they are as yet preferring the buggy for courting. The boys say the motor car has other faults, such as requiring two hands to drive.

PREDICTS UNPRECEDENTED PROSPERITY

J. D. Mansfield, general sales manager of the Durant-Dort Carriage Co., Flint, Mich., says:

"I have recently returned from a three weeks' trip through the cotton district, and it is very plain to be seen that the tendency in that territory, especially, is toward a better feeling generally regarding business conditions. Our correspondence from various sources in the United States within the last couple of weeks shows an increase in confidence in conditions and we have every reason to believe that it will only be a matter of a very short time until our factories and various institutions in the country will be enjoying prosperity such as they have not seen in years."

AUSTRALIAN TRADE

Despite the disruption of the shipping of Australia since the beginning of the European war, revenue returns for customs and excise during the last October showed an increase of approximately \$260,000 over the returns of October, 1913, according to Mr. Niel Nielsen, Trade Commissioner in America for New South Wales.

For the four months from July to October more than \$2,140,000 was collected in excess of the receipts for the same period a year ago for all Australia. In New South Wales a substantial portion of the gain was recorded.

Mr. Nielsen also said the Australian Federal Parliament had before it a bill providing for material extension of the operation of the Commonwealth bank, and for increasing its capital from \$5,000,000 to \$50,000,000.

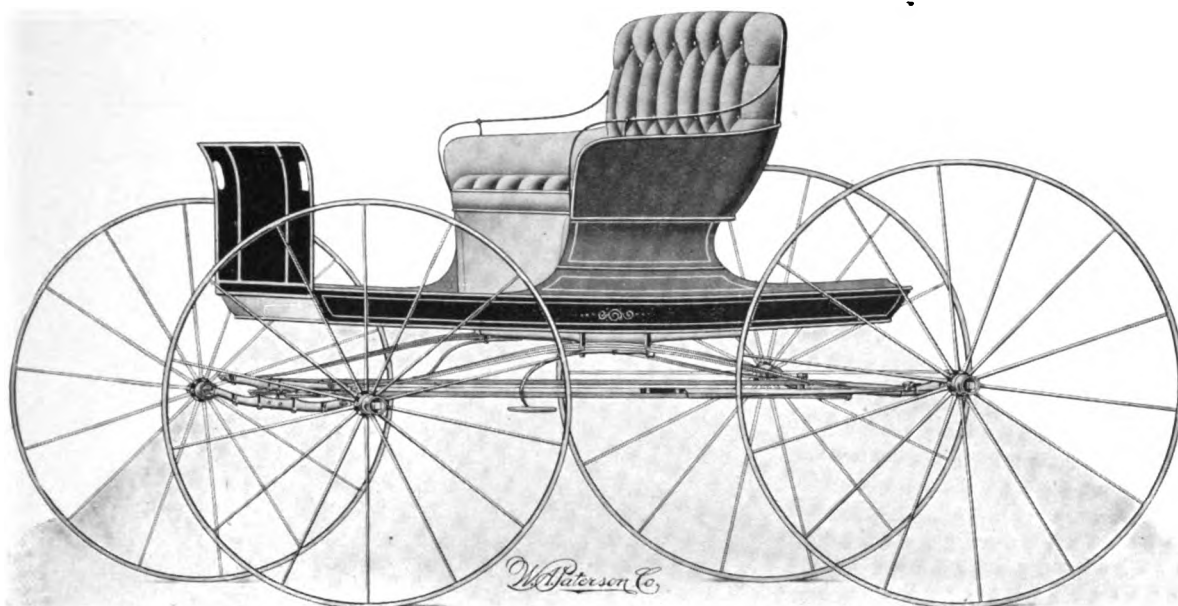

CONCORD WITH SOLID RISERS
Built by W. A. PATERSON CO., Flint, Mich.

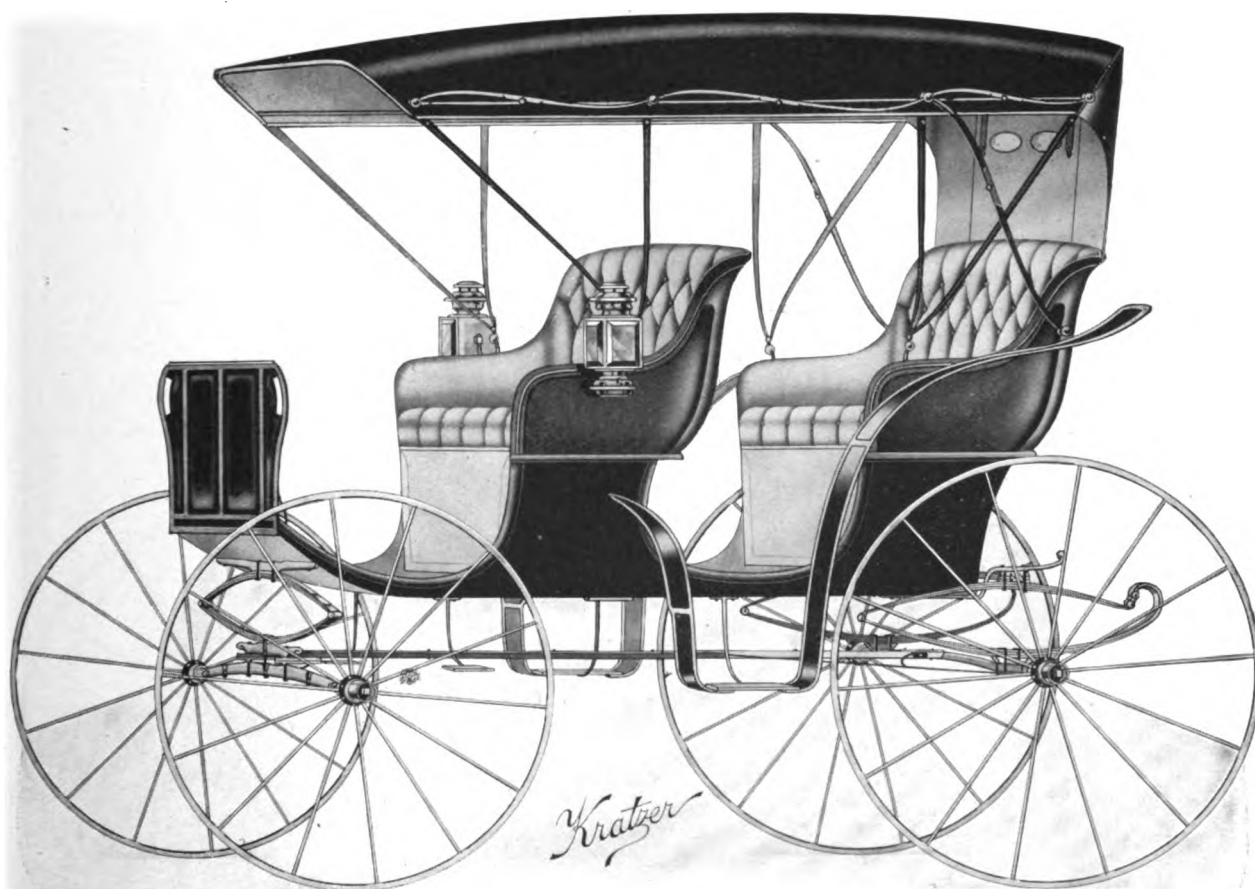

DEPRESSED PANEL SURREY
Built by KRATZER CARRIAGE CO., Des Moines, Ia.

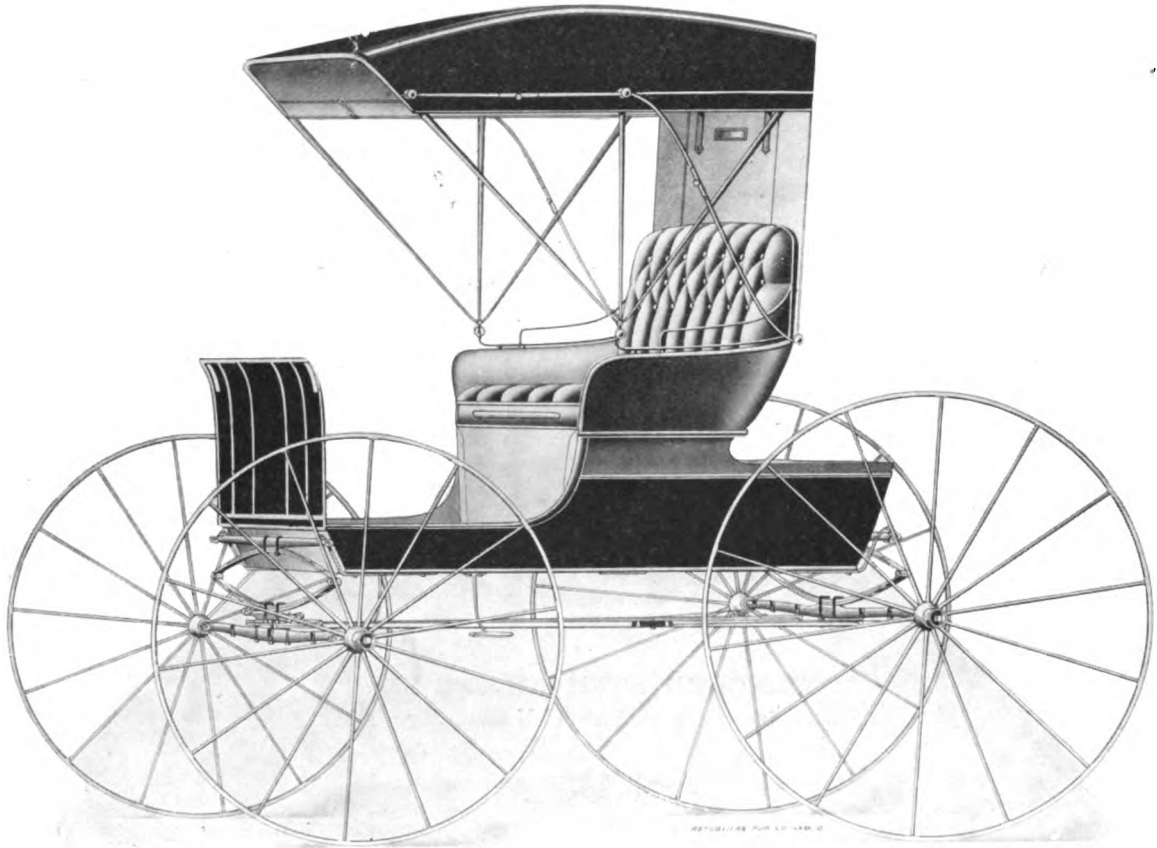

CORNING BODY TOP BUGGY
 Built by **THE PEABODY VEHICLE CO., Fostoria, O.**

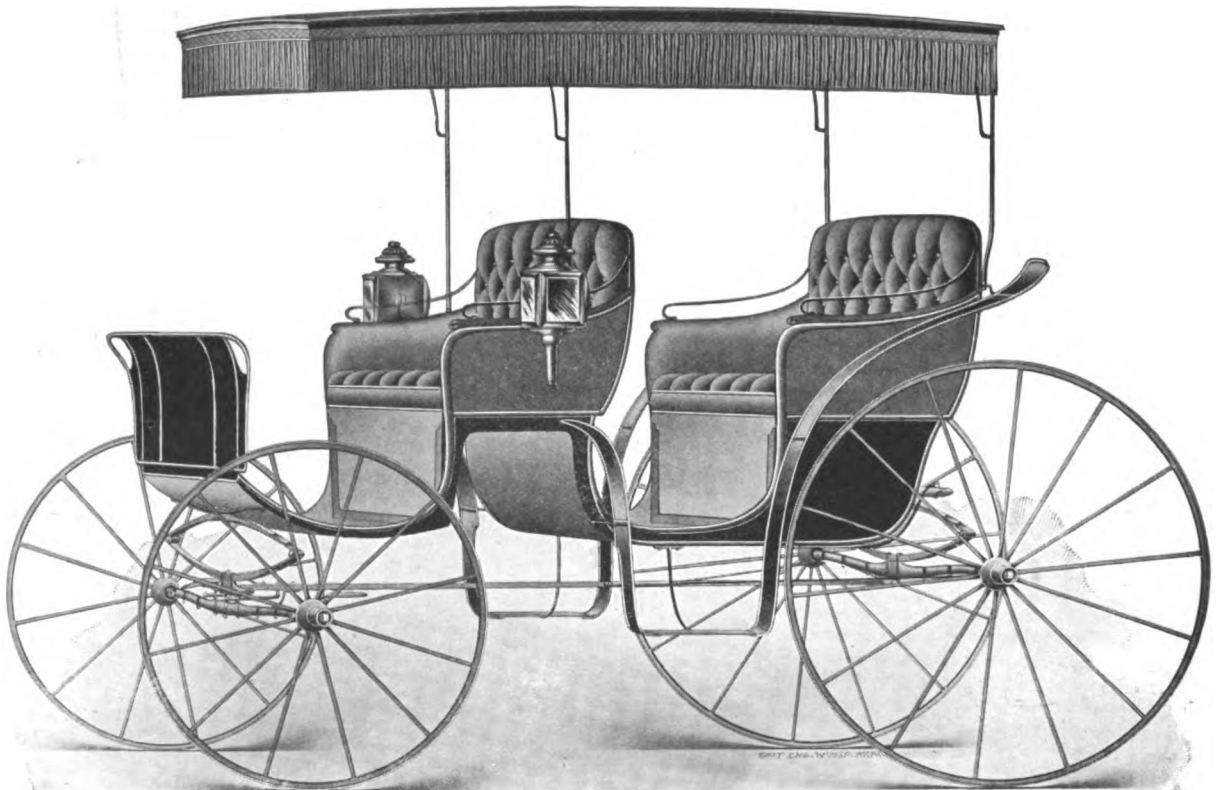

ARLINGTON CUT-UNDER SURREY
 Built by **MIFFLINBURG BUGGY CO., Mifflinburg, Pa.**

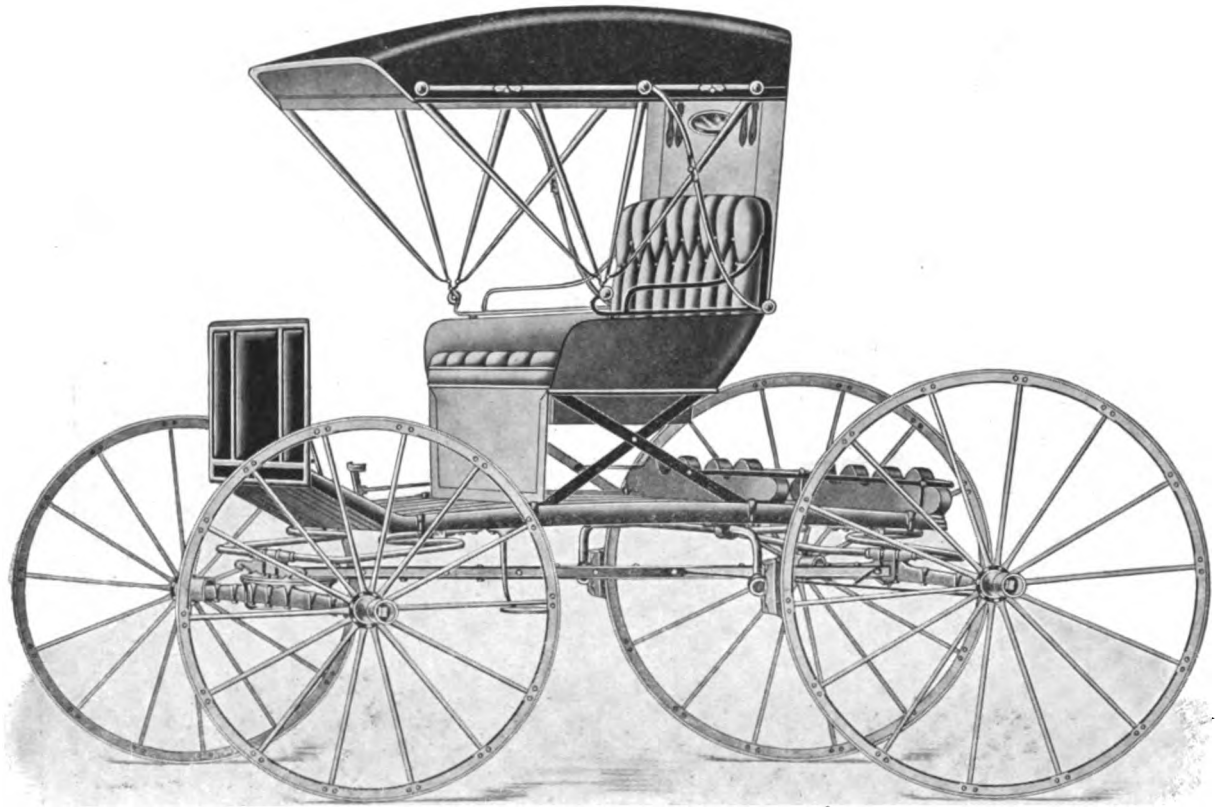

HEAVY OIL WAGON
Built by **REX BUGGY CO.**, Connersville, Ind.

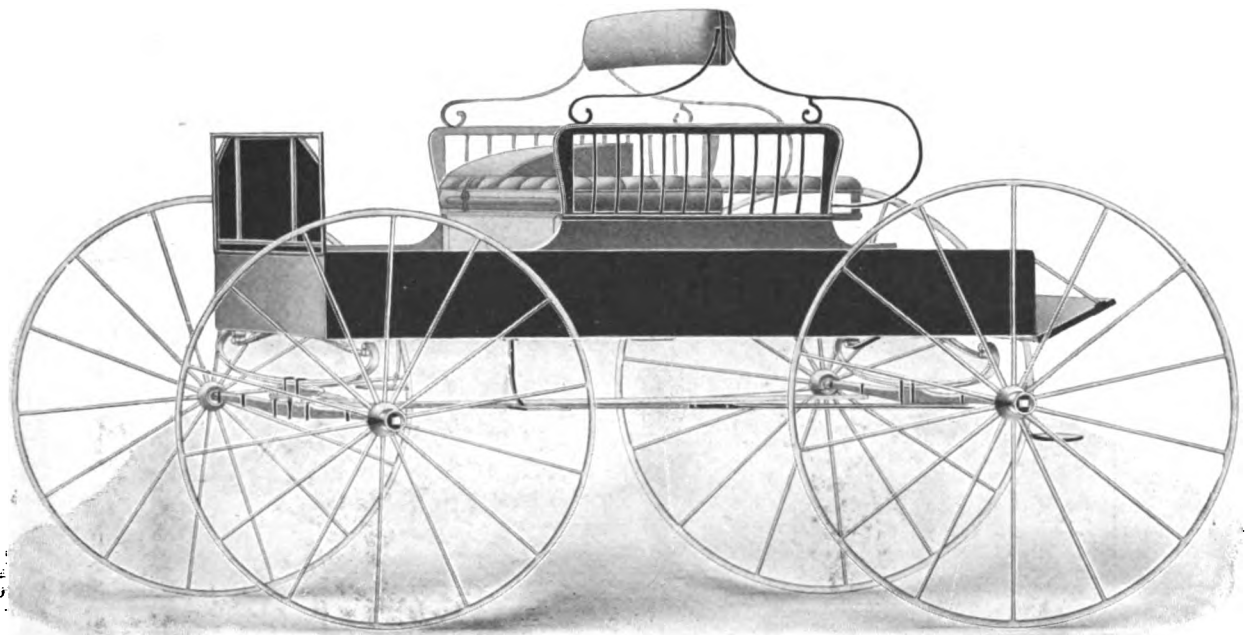

ATTRACTIVE DOS-A-DOS
Built by **WM. N. BROCKWAY, INC.**, Homer, N. Y.

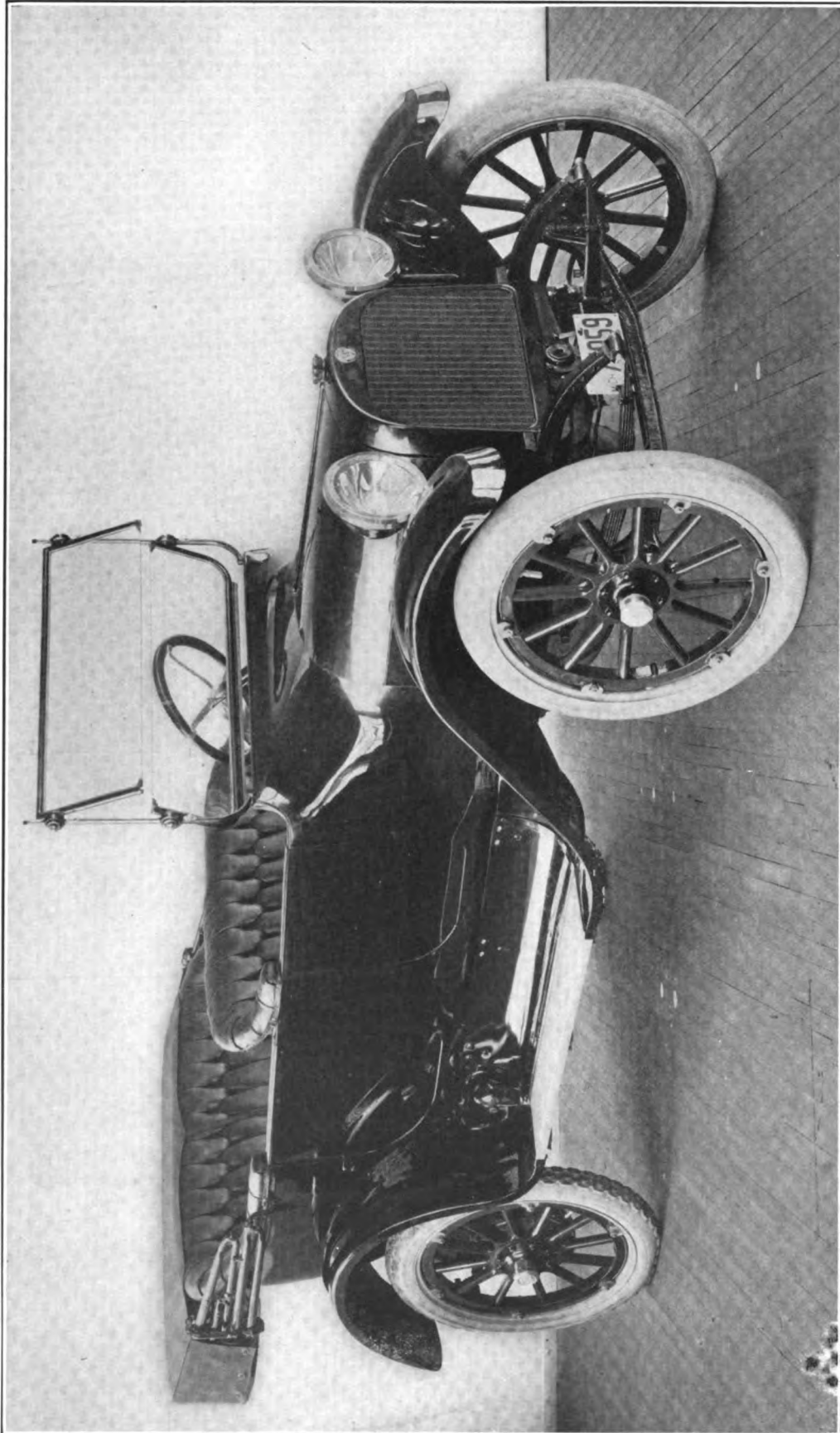

THE NEW DODGE AUTOMOBILE
Manufactured by DODGE BROTHERS, Detroit, Mich.

THE DODGE AUTOMOBILE

On the opposite page is illustrated the much talked of Dodge automobile. This car is manufactured by Dodge Brothers, Detroit, Mich., and is a light five-passenger touring car, weighing about 2,200 pounds, and will sell for \$785, equipped with electric lighting, starter, one-man top and similar fittings. Until about a year ago the Dodge brothers were one of the chief makers of parts for the Ford car, and were among the largest stockholders in the Ford Motor Co. When the announcement was made that the former concern had decided to quit making Ford parts and bring out a car of its own, the motoring world looked for something startling in the line of low-priced cars.

The Dodge car is furnished only in five-passenger touring form, and is a streamline machine of sturdy mechanical construction. The specifications include a block-cast, L-head motor, $3\frac{3}{8} \times 4\frac{1}{2}$ size; gearbox in unit with the engine; drive through a propeller shaft inclosed in a torsion tube to a floating rear axle; cone clutch; three-quarter elliptic rear springs; overslung frame; and left drive with center control.

The wheelbase is 110 inches, and tires $32 \times 3\frac{1}{2}$ all around, the rear set being of the non-skid variety. Equipment is of note in view of its completeness, taking in such items as North East combination motor-generator set for cranking and lighting, Eisemann magneto, Jones speedometer, one-man top, rain vision and ventilating windshield to which the front of the top fastens, Willard battery, etc.

The body is a trim affair being an example of all-steel construction. Even the frame is of steel. Upholstery is of machine and hand-buffed leather. The body and bonnet are united without any disturbing lines to the consistent slope of both cowl and hood, which is finished out with a radiator of the coped-over edge type. The fender construction is of the oval molded type rounding into the splashers. The cowl board arrangement shows that the instruments necessary in driving are placed a little to the drive side of the center. To the right of them is a small compartment with a lock which may be used for carrying gloves, etc. The instrument panel is of pressed steel.

The motor, S. A. E. rating of 24, operates with a compression pressure of 65 pounds per square inch. There is no question that this motor is amply powerful for the car, for with a ratio of stroke to bore of 1.16, it has a displacement of 212.3 cubic inches. When the car is running at about 10 miles an hour on high, the motor is turning over at 380 revolutions per minute. The general arrangement of the motor is of the type in which the cylinder head is a separate piece, bolting to the cylinders. The intake passages are cored through the single opening to the carbureter on the left to the intake ports on the right, the cored passages being between cylinders Nos. 2 and 3. The exhaust manifold is a separate casting with an opening individually from each cylinder. A single long plate incloses the valve mechanisms.

On the left is mounted the motor-generator in addition to the carbureter, and the magneto and water pump are placed on the right. The suspension of the motor is three-point.

The pistons, of gray iron, and $4\frac{3}{8}$ in. long, are fitted with nine thin steel rings each, three to a groove. Connecting rods attach to the pistons by $13/16$ -in. pins held to the piston by set screws, the rods bearing on them with $1\frac{3}{4}$ -in. phosphor bronze bearings. The rods are vanadium steel drop forgings of usual H-section, and measure $9\frac{1}{8}$ in. center to center of bearings. The crankshaft is of the same material as the rods and rotates on three brass-backed babbitt bearings.

Oiling is by the circulating splash scheme which makes use of an eccentric pump driven by spiral gear on the crankshaft. Cooling is by a centrifugal pump driven at crankshaft speed and operating in conjunction with a six-blade pressed steel fan belt driven from the pump shaft, which is carried on an adjustable bracket to take up belt stretch. A 5-quart radiator of tubular construction with six rows of 20 vertical tubes each

is the main cooling agent. The total water jacket capacity is two gallons.

Ignition current is supplied by an Eisemann G-4 high tension magneto of waterproof type. This is driven from the end of the pump shaft and it connects to a set of A. C. spark plugs with the firing order, 1, 3, 4, 2.

The combined motor-generator which takes care of all electrical requirements except the ignition is a North East 12-volt unit. It operates in the regular way either as an electric motor for starting or as a generator for charging the battery and lighting the lamps. The battery, carried under the left front seat, is a 12-volt Willard of 40 ampere-hours capacity.

The starter pedal is placed in the center of the toe board, and after switching on the ignition, it is only necessary to press this pedal to turn the crankshaft with a torque of 35 foot-pounds. After the starter pedal is released, the unit automatically becomes a generator. Connection between motor and final drive is by a cone clutch having spring inserts under the leather facing. The gear-set is a three-speed, selective, sliding type, one which is unusual in that when on direct drive the counter-shaft gears do not rotate.

The floating rear axle has a pressed steel housing with large plate at the rear giving access to differential and bearings. The differential is carried on the removable front cover portion of the housing. The steel stock used is $3/16$ -in. thick and the gears are vanadium steel heat treated. Timken bearings are used throughout the axle assembly and in rear wheels. The axle gear ratio is 3.615 to 1.

Chrome vanadium steel self-lubricating springs support the frame, the front set being half-elliptic and the rear three-quarter. They are overslung on the axles. The frame is well braced with three cross members, and is pressed from $5/32$ -in. stock into channel section $3\frac{1}{2}$ in. deep. There is a kick-up at the rear to clear the axle, and the front bottle necks, allowing the car to turn in a 40-foot circle.

The steering gear is of the irreversible nut-and-sector type. The spark and throttle control levers are placed on a sector under the steering wheel. The round 15-gallon gasoline tank is hung at the rear by forged brackets and the feed to the carbureter is by air pressure maintained by a camshaft pump. The instrument board carries a hand pump for auxiliary air pressure on the fuel in this tank. Tread is standard 56-in. with the option of 60 in.

DETROIT'S HORSE-DRAWN VEHICLE BUSINESS

Nowadays you hear much of automobile and commercial vehicle makers. They have been in the limelight for some years and they promise to hold their place with an ever-increasing demand.

But this does not mean that the old business of manufacturing wagons and carriages has gone. On the contrary, there are upwards of 30 concerns in this city which are building horse-drawn vehicles and making trimming and parts for them.

Naturally, wagon building is one of the old trades in Detroit. It came here with our civilization, for in the early days the vehicles had to be built here, means of bringing them to the new settlement being very limited. From the original hand workmen it grew until factories were established and Michigan became a leader among the wagon and carriage building states in the union.

The use of wagons is general. They are found in all industries, even parts and supplies for some of the automobile companies being drawn to their destination by horses. As yet nothing has taken the place of horses. More motor propelled vehicles are seen on the streets every day, also more horse-drawn wagons, for Detroit is growing and there is plenty of room for both.

If one wants the strongest sort of proof of the desirability of work horses let him go to one of the big vendues which are held every week or oftener in Detroit. Try and buy a nice

pair for heavy hauling or for medium grade work, which requires a team, and note the rapidity of the bids and the final figure at which the team is knocked down to the man who wants them more than others.

Horses never have sold for as much money as they now bring and the greatest difficulty in the sale marts has been to corral enough of them to go around. Old Dobbin is not backing up a bit, on the other hand he is a pretty good asset for a person to have around, for you can turn him into money about as quickly as any other possession.

The builders of trucks and vehicles for heavy work have not experienced any great trouble in disposing of their output. The wagon trade has held up very well, although in slack times, of course, there is not so much use for wagons, hence those in commission do not wear out as quickly.

The big trucking concerns stick to horse-drawn wagons for most of their work between factories and wholesale houses and the railway and steamer freight sheds. The comparison between them and motor trucks at these receiving points is in favor of the horse, for there are some kinds of work in which gas is not as good fuel as oats.

Wagon building has been undergoing the same change as business in other lines. Experience has taught that there is more economy in certain styles than in others which were the vogue and the makers have been turning out the new patterns. The trucks have greater capacity and there is a difference in the wagons.

Taken all the way through, the workmanship of the Detroit wagon and carriage makers is the best. In the days of the victoria, the landau, the brougham and other pleasure vehicles Detroit had an enviable reputation, one firm being rated as the leader in these lines.

The wagon makers here always have held their own in face of strong competition from the state and outside. The quality of their goods has told the tale, for the vehicle made for work must be strong and honest to stand the strain imposed upon it. As one of the makers said: "Perhaps we do too good work, for the wagons never seem to wear out."—Detroit Free Press.

RADICAL CHANGE IN CAR DESIGN AND REFINEMENTS OF DETAIL TO BE SHOWN AT GRAND CENTRAL PALACE SHOW

It is said that no automobile show in years has produced as many novelties and surprising improvements in design as will be seen at the fifteenth annual National Automobile Show, under the auspices of the National Automobile Chamber of Commerce, which is to be held in Grand Central Palace, January 2 to 9. No transition from one season to another has revealed such marked strides in the matter of equipment, refinements of detail, new ideas in accessories, as well as radical changes in design, as will there be seen.

Slack business in certain quarters last summer gave a number of makers opportunity to try out many new ideas and make improvements in their product, so that never before has it been possible for a buyer to get so much for a given amount. While prices of cars have not been materially reduced, it will be observed on all sides that much more is being given for the money in 1915 models than ever before, especially as regards equipment and conveniences. The fact that the price of fuel has been universally lowered during the past year has encouraged more prospective buyers of cars.

Many of the new features to be sprung at the show are being kept secret by the makers, but news of certain of these already has leaked out. Among the surprises in store are several new cars equipped with eight-cylinder motors. Almost equally startling are several of small six-cylinder cars which it is said will sell under \$1,000.

Fenders as a class are crowned so as to hug the wheel somewhat more than the old style, and to prevent splash more efficiently, but at the same time avoid the danger of the tire

striking the fender on a sharp rebound after passing over a bump.

The "one man," or "one hand" type of top will be found on the majority of touring cars, while interchangeable or convertible bodies have been improved to a point where they are practical and make it possible for a buyer to secure a combination open and closed car that is not cumbersome and is easily adjusted.

Great development will be noticed in small coupe bodies. In fact, the coupe has increased in popularity each successive season, and 1915 will see it more popular than ever. Innovations in seating arrangement, especially in closed cars, will be shown by the majority of exhibitors, and seats that slide out of the way and disappear when not in use, or swing so as to permit easy ingress and egress, will be noted in great number. Whereas a couple of seasons ago there were but few electric starting and lighting systems offered, there are now numerous ones to be seen, and in those that have been on the market two years or more much improvement has been made.

Not only have large cars, such as limousines, berlines, and heavy touring cars improved greatly in appearance, but very light cars have been much refined in beauty and utility.

WARRING NATIONS BUYING AMERICAN HIDES

The Wali Street Journal in a recent issue notes a sharp advance in the price of hides. This is due, we are told, to the demand of European nations for grades of leather suited to saddlery and other articles of war equipment.

It is apparent that our domestic supply of leather for upholstery and other purposes will be reduced materially by this big increase in the exportation of hides.

Shipments of the hides in their entirety—that is, without subjecting them to splittle processes—makes a very decided inroad on the stock of split leathers used by American manufacturers of upholstered products, or any requiring split leathers. How much our domestic leather supply is affected by the increased exportation of entire hides cannot be determined at a moment's estimation. It is sufficient to say that for every hide exported there is removed from the American split leather market at least two splits or sides. Obviously, our exportation of hides is developing a demand for artificial leather.

It may not be generally known that the various "splits" from an animal's hide are processed in a way that places them in the artificial class. The coating applied to the fleshy splits to give them strength and a surface for graining is very similar to the solution spread by mechanical means on the cloth backing of our best grades of artificial leather familiar to the trade and public by extensive advertising campaigns.

EDISON-FORD ELECTRIC MAY COME

It is rumored that an Edison-Ford electric car is a possibility. Thomas A. Edison, the electric wizard, was the guest of Henry Ford at his home at Detroit, Mich. The two went through the Ford plant and then came the report, it is alleged, that they have collaborated on a low-priced electric car. It is stated that if further experiments prove successful the new vehicle will be put on the market. It is substantially a Ford machine with an Edison battery and electric motor supplanting the gasoline motor.

AFTER PARCEL POST CONTRACT

The Wagenhals Motor Co., Detroit, Mich., will manufacture both electric and gasoline cars for the 1915 season. Both will be of the three-wheel type, will be built along the same lines and will be similar in appearance. The Wagenhals Co. is after the government order of something like 1,000 commercial cars which are to be purchased for use in connection with the parcel post.

MOTOR TRUCK GUN TRANSPORTS

Types of Specially Constructed Motor Vehicles Utilized with Success by Germans and Belgians—Special Equipment for Loading Artillery

In addition to ordinary touring and commercial vehicles used for the transport of officers and supplies, a few widely different types of specially constructed military motor vehicles are being used in the present war, says Eric W. Walford, in the current issue of *The Autocar*, an English motoring print, and from the evidence that a layman can accumulate, these vehicles seem to have justified their employment. It seems probable, therefore, that similar types will form a regular part of every arm's equipment and that, before long, this branch will be developed considerably and a number of different kinds of vehicle be used.

Thus there will be lightly armored cars of high speed for scouting, and we know that such cars have been used with suc-

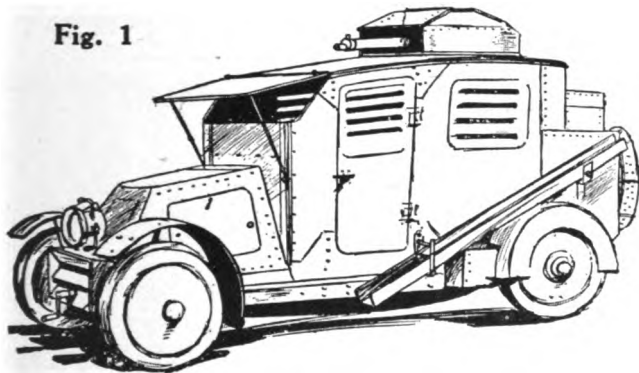

Fig. 1—Charron armored car with machine gun in revolving turret

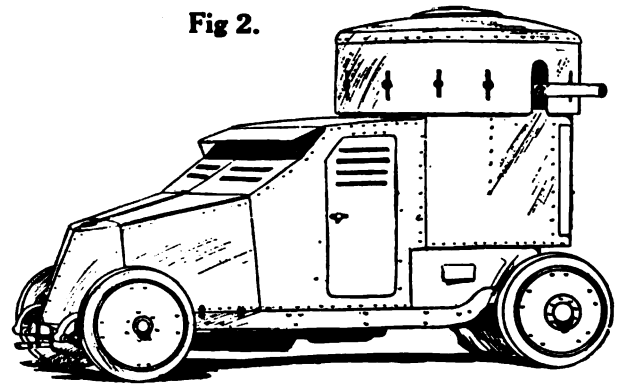

Fig. 2—Schneider military car equipped with gun in revolving turret

cess in Belgium by the Germans. Such cars are hardly fighting machines, and do not, as far as I am aware, all carry machine guns. There is, however, another type, which could give a very good account of itself in offensive work, and which might be termed a "fighting machine." There would be, moreover, cars far the rapid transport of guns, and modified forms in which the guns could be used when in place upon the car. It will be obvious that this last type would be particularly useful when attacking hostile air craft. When it is considered that the air craft would probably be traveling at any speed between 50 and 100 miles an hour, and that the gun carriage probably would not do more than 30 miles an hour, it will be obvious that there will be considerable benefit in being able to fire the gun without having to unlimber it, which would necessarily take considerable time.

The three latter types of vehicles, that is, the motor fighting machine provided with machine guns, the gun carriage, and the

rubber ring, and is absolutely immovable. When the gun is to be trained afresh, the hand wheel is rotated to raise the turret slightly, allowing it to be turned in the required direction. The machine gun is mounted on a cross bar D, with the usual elevating gear, etc.

The front of the car is provided with a hinged shield A that may be instantly dropped; behind this there is carried from the dashboard a lamp with a movable shutter that may be utilized for signaling. The radiator in this type of car is arranged low down in front, and it is enclosed by steel plates with louvers for the passage of the air. Ammunition is stored at the back in the receptacle E, while on each side of the vehicle, just over the rear wheels, is carried a channel steel ramp or gutter, which can be used to bridge over ditches, etc. This machine is the production of the Societe Automobiles Charron, Giradot et Voight, the makers of the C. G. V. touring car.

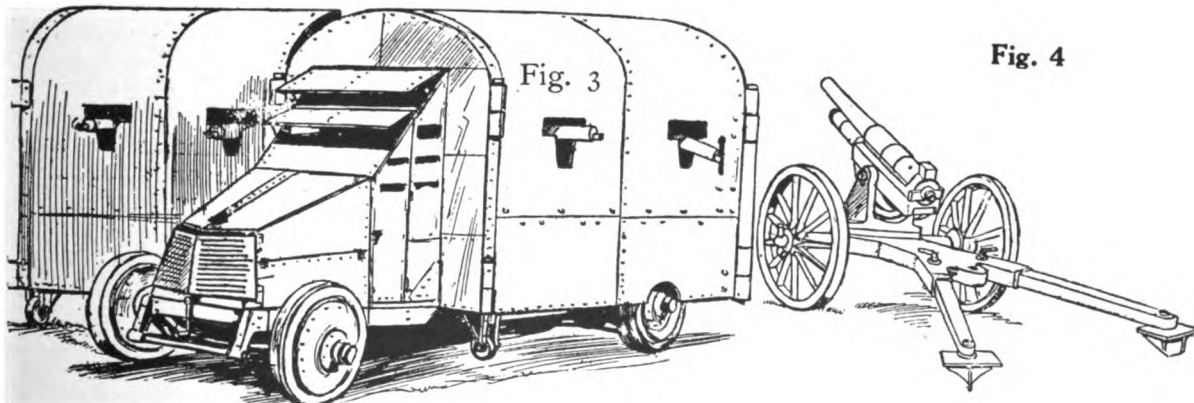

Fig. 3—De Sauteiron motor battery of machine guns; the sides of the vehicle can be swung out to bring all the guns in line. Fig. 4—Krupp motor gun carriage, showing the method of anchoring during action.

Schneider, the well known maker of Le Creusot, has produced for use on armored cars a special form of turret, which is shown at Figs. 2 and 8. The turret comprises a lower cylindrical part that is attached to the frame of the car and is a fixture. Above this is the rotatable turret that is provided with rollers A (Fig. 8) running on an inwardly projecting ring on the fixed turret. This ring is toothed on its inner side, and engaged by the gear wheel B. The gun is carried on a pair of brackets from a part of the rotatable turret, and these brackets support

are represented by the black dots shown in the small diagrams at Fig. 10. There are also two machine guns which are a fixture in the center of the car, these facing fore and aft respectively. By turning the side screens around into the various positions shown at Fig. 10 the car may be used for advance or for rear guard attacks, and it may be effective also in a lateral direction without turning the car, in each case the gunners being under shelter. As may be noted from Fig. 9, the side screens are supported on casters to allow them to be

Fig. 5

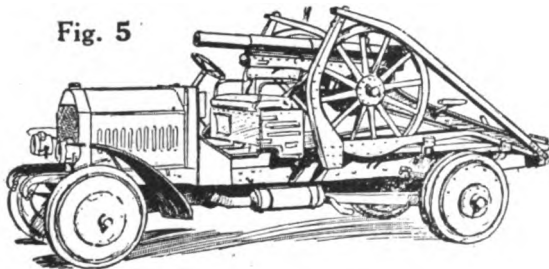

Fig. 5—Krupp gun transport, as it would appear with gun in position

the shaft on which the gear wheel B is fixed. Rotation of the gear wheel B is effected by means of the bevel gearing at C and a chain connected to a spindle D. On the gun is provided a kind of cycle seat E, and the spindle D carries cranks and pedals. In this way the gunner, seated on the saddle, is able, by pedaling, to rotate the turret and gun, leaving both hands free for aiming and working the gun.

A most ingenious form of motor "battery" is the production of an Italian artillery major. This vehicle is provided with a

Fig. 6

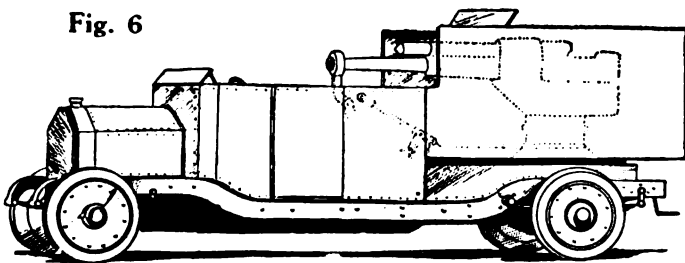

Fig. 6—Krupp heavy vehicle carrying mounted howitzer, and fitted with anti-vibration devices

number of machine guns, and constitutes really a kind of mobile fort. As indicated at Figs. 3 and 9, the main external appearance of the vehicle somewhat resembles the C.G.V. construction shown at Fig. 1, the vehicle being practically enclosed by armor plating. The sides, however, are not fixtures, but are hinged at the front and rear, while each side is integral with a part of the platform.

The platform, therefore, is divided longitudinally into two parts, and on each side are mounted two machine guns, which

Fig. 7

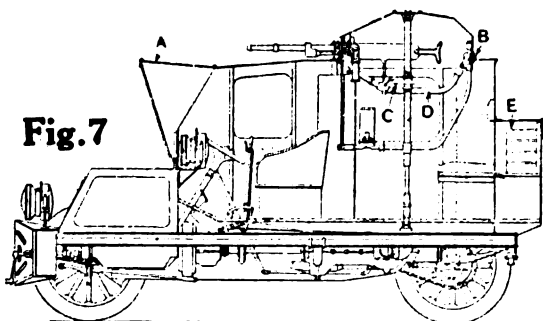

Fig. 7—Arrangement of Charron armored car

Fig. 8

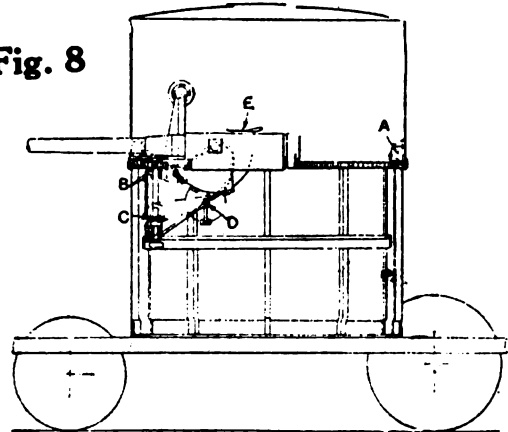

Fig. 8—Disposition of gun and turret mechanism in Schneider military car

rotated easily. The arrows in Fig. 10 show the directions of gun fire with the side screens in different positions.

Motor gun carriages will next be considered and, from the following, it will be seen that the Germans, through Krupp's, have given a great amount of attention to this point. One construction that is in use in the present war is shown at Fig. 11, and dates from as long ago as 1908. Here a strong motor lorry is utilized, and the platform at the back is specially con-

Fig. 9

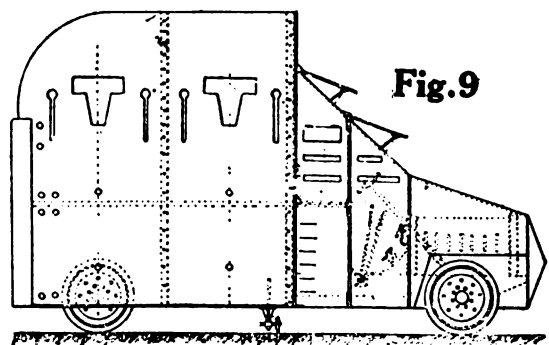

Fig. 9—Outside elevation of De Sauterion motor battery

structed with channel tracks for the reception of the wheels of the gun carriage, the barrel of the gun projecting forward by the side of the driver and over the bonnet, which latter is not shown in the accompanying drawings. The feature of this construction is the simple method by which the gun is secured.

This is effected by using ramps by which the gun is drawn on to the platform. These ramps are hinged to the back of the vehicle frame. They are turned over so as to rest upon the

Fig. 10

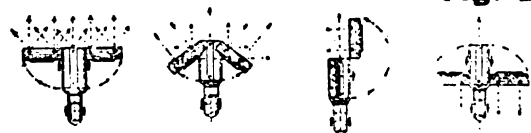

Fig. 10—Diagram showing lateral radii of gun fire possible with the De Sauterion arrangement

tops of the wheels, and are secured to the ends of the stops by spring catches. The spade at the end of the trail of the gun is arranged to bear against the frame of the car. In another arrangement of the same idea the ends of the ramps are adapted to grip the axle of the gun carriage.

It will be observed that this provides only for the transport of the gun, and does not allow of it being used without being unlimbered. In a design, which is shown at Fig. 4, the gun may be used when it is on the car, as well as in the ordinary way.

Fig. 11

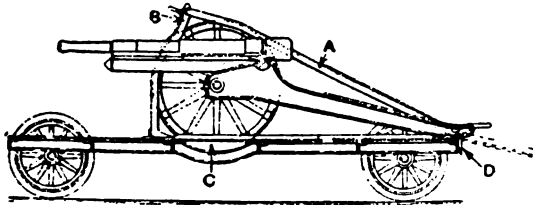

Fig. 11—Krupp motor gun carriage, with gun in position of limber

In the drawings is shown a gun that may be used for high angle firing, and it is designed ostensibly for offensive purposes in connection with air craft. The gun is provided with a pivot mounting on its under carriage, so that it may be rotated completely in a horizontal plane. It may also be turned vertically through a very wide angle.

A much larger gun, mounted upon a motor vehicle, is a later Krupp production. Here again, as seen by the drawing at Fig. 6, the gun is provided with a pivot mounting upon the frame of the car, and it is housed in a kind of turret attached to the platform that is provided with ball bearings for its rotation. The two rotate together, but there is no positive connection between the platform and the gun, a provision that precludes the possibility of injury from the shock.

BODY COMFORTS

It is rarely that any one season witnesses so many refinements in body construction and finish as are found in many of the 1915 cars. Frequently more than a dozen alterations of one nature or another exist, all carried out with the one thought of giving greater comfort to the passengers. That this is essential is well borne out by the comment of a pioneer automobilist, who has been driving cars since the days of the early steam types, to the effect that comfort in riding is today one of the major considerations in an automobile, if not the great one!

Comfort, says Automobile, has been increased for next season by a general improvement in seat design, the cushions in many cars being tilted to meet the needs of the passenger, as well as the upholstery being heavier in most low and medium priced machines.

The low body is always desirable, and many of the new models are well featured in this respect. The underslung spring has played its part in this movement, so has the dropped frame, and so has the dropped front axle.

Four-passenger bodies give evidence of being slightly more popular than the present year, this tendency being in line with European trends previous to the war. The four-passenger body gives a much better design, getting away from the width at the back seat and making it possible to have the maximum body width between the front and rear seats, if so desired. This design adds to the stream-line effect.

Early announcements point to more colors than this year, there being many more color options in medium and high-priced cars than formerly. The staid black will not be so dominating, notwithstanding the natural tendency the war would have toward somber colors. While black is the great predominating

tone, and greens, blues and grays in many varieties have large followings, there are many concerns that are giving other semi-gaudy color combinations that should suit the most fastidious.

Production and manufacturing requirements have produced a few tendencies for next season. In general there are fewer body models with many of the lower-priced cars, the one-body policy taking hold in not a few cases. With medium and high-priced cars there are often more models than formerly, the cabriolet, coupelet or other new ideas being included as standard types and often listed as stock models. The number of limousines has not materially increased, but coupes and sedans are more in evidence.

FOREST NOTES

Forbach, Germany, is said to have the most profitable town forest known; it yields an annual net gain of \$12.14 an acre.

The state school of forestry at Bottineau, N. D., announces that it will have one million trees for distribution to the citizens of the state during 1915.

Apple wood, used almost exclusively for saw handles, also furnishes the material for many so-called brier wood pipes and particularly for the large wooden type used in printing signs and posters.

One of the most expensive woods used regularly in an established industry in the United States is boxwood, the favorite material for wood engraving. It has been quoted at four cents a cubic inch, and about \$1,300 by the thousand board feet.

What is supposed to be record speed in getting men to a forest fire, is reported from Oregon, where on one of the national forests, a ranger went to town, hired ten men, and got this force to the fire twelve miles away within 48 minutes after he was notified by telephone.

The Sihlwald, or city forest of Zurich, Switzerland, adds to the town's revenues \$7.20 per acre a year, reducing the amount needed to be raised through taxation by more than \$32,000.

In northern Idaho and Montana, which had many fires during the past summer, 35 per cent. of the fires on national forests were caused by railroads, 26 per cent. by lightning, and 10 per cent. by campers. The remainder were due to brush burning and other miscellaneous or unknown causes.

The annual cut of British Columbia timber is approximately two billion feet. There are 420 mills and 790 logging camps in the province, employing about 60,000 men.

The Massachusetts forestry association offers as a prize the planting of 50 acres of white pine to the town which gains first place in a contest for town forests.

The Boise national forest in Idaho had 30 fires during the past summer, yet 28 were held down to less than 10 acres, and of these 15 were less than one-quarter of an acre. The supervisor says this success was due to a lookout tower, and to efficient telephone and heliograph service.

CINCINNATI CARRIAGE MAKERS' CLUB

The November meeting and dinner of The Carriage Makers' Club of Cincinnati was held at the Business Men's Club on the evening of the 12th. After the dinner the members were invited to attend the meeting of The Cincinnati Credit Men's Association, who had as their speaker United States Senator Theodore E. Burton, of Cleveland.

THE AMERICAN MOTOR VEHICLE INDUSTRY

According to Mitchell May, secretary of state, New York, over 1,500,000 motor cars of all descriptions were registered in the several states of this country last year, and of this number 88 per cent. were pleasure cars and the remaining 12 per cent. commercial, this proportion being based upon the registration returns in New York state where, of the total registrations of 135,000 motor vehicles, upwards of 15,000 were commercials.

The number of foreign cars imported into this country during the past three years has been negligible, less than 4,000, while the number exported has been enormous.

As a matter of statistics, 94 per cent. of the cars used in this country are of American make. The motor cars owned in the United States aggregate a present value of nearly \$2,000,000,000, an estimate placed on a basis of rating one-half of the total number of cars registered last year at \$1,000 each, and the remaining half at \$2,000 each, both figures being exceedingly conservative, as the price of motor cars varies from as low as \$400 to as high as \$6,000 for the six-cylinder limousine.

The statistics further show that close to \$600,000 was spent upon the purchase of new motor cars by American motorists last year, and to this sum is yet to be added the values of the accessories, the supply of which forms a very substantial branch of the motor car trade.

But the annual expenditure for new machines, large as it is, is not all the expense, as the cost of running is heavy, witnessed by an industry which motoring has built up, namely, tire manufacturing, which is becoming almost as large as the motor car building trade itself. Next to the tires is the cost of gasoline and lubricating oil, which is amongst the heaviest in the motorist's expenditures. Besides the cost in repairs, renovation and periodical "overhauls" amount to many millions, while added to this is the sum of the annual registration and license fees, which since 1911, when a careful collection of statistics from 36 states was made by the secretary of state's office, amounted to exactly \$3,746,938.55. Since that time, especially during the last year, over twice this license record was shown, totalling approximately \$9,500,000 in license fees.

The actual number of professional drivers licensed in this country during 1911 were 174,087 chauffeurs, and since that time their number in this country has increased four-fold. If the wages of this number were fixed at the rate of \$15 per week and the compensation of others employed about the car were added, the total would reach upwards of \$11,000,000 annually, and thus the running expenses of the motorists, added to the purchase cost and incidentals, would reach the enormous aggregate of some billions of dollars.

Taking all the expenditures of owners of motor cars, the benefits directly to the industrial classes must aggregate close to a billion dollars annually. If the average of the wages and salaries of all engaged in the motor trade and other connected industries be taken into consideration as \$800 per annum, it means that upwards of 1,000,000 obtain their employment by that industry, and that something like 3,000,000 of the population are directly or indirectly supported by the manufacture of motor cars.

DYESTUFFS

A sudden realization that this country is almost wholly dependent upon Germany for dyestuffs as also for many important synthetical drugs marked the early days of the war and quickly developed into consternation in the textile and other special industries as the paucity of stock in hand became apparent. A general and insistent demand arose for the immediate inauguration of an American coal tar industry which should relieve the humiliating situation and render impossible its recurrence. Committees were everywhere plentiful but capital for plants was everywhere scarce. It is likely to remain scarce for many compelling reasons. The German coal tar industry

is an exceedingly highly organized one, the various branches of which are minutely specialized and closely interrelated. It is not the sort of industry to be developed while you wait unless you are willing to wait a long time. We waited several decades in vain under a 30 per cent. tariff.

Fortunately our immediate needs are being satisfied by shipments through Rotterdam and there seems to be no serious danger of a future dyestuff famine. Meanwhile a few special products are being made here and both their volume and number will doubtless gradually increase.

ARMORED AUTOMOBILES IN WAR

A highly important development of the European war is the demonstrated worth of the armored automobile service, in which the Germans are especially strong. Dashing at high speed over the splendid roads of Belgium and northern France, these German cars have been most successful as "advance agents" of the Uhlans, and in other capacities, and it was not until the French grasped the necessity of destroying or digging pitfalls in the roads that they were able to negative in any degree the great value of this motor service to the enemy.

Realizing the significance of this development, Representative Daniel R. Anthony, of Kansas, member of the committee on military affairs, has prepared a bill providing for the creation of an automobile arm of the military service of the United States and the purchase of armored automobiles. Military experts are of the opinion that this country has too long neglected the development of the motor vehicle in the transportation branch of the army.

COMING SHOW DATES

January, 1915

- January 2-9—Show, Grand Central Palace, New York City.
- January 9-16—Show, Philadelphia.
- January 11-16—Show, Buffalo, N. Y.
- January 16-23—Show, Cleveland, O.
- January 23-30—Show, Montreal, Que.
- January 23-30—Show, Coliseum and Armory, Chicago.
- January 30-February 6—Show, Minneapolis.

February

- February 8-15—Show, Kansas City, Mo.
- February 15-20—Show, Omaha, Neb.
- February 23-27—Show, Syracuse, N. Y.

March

- March 6-13—Show, Mechanic's Building, Boston.
- March 8-15—Show, Des Moines, Ia.

DEATH OF CHAS. J. FORBES

Charles J. Forbes, vice-president and general manager of the Forbes Varnish Co., Cleveland, O., was taken suddenly ill at his office on November 19, and died at his residence on Clifton boulevard, the following day. Mr. Forbes was born at Parma, O., February 2, 1853, and went to Cleveland when he was 14 years old, where he received his early education. Afterward he attended Oberlin College. In 1888, Mr. Forbes became affiliated with the Murphy Varnish Co., later leaving them to become sales manager of the Standard Varnish Co., of Chicago, which connection he severed when he returned to Cleveland in 1906 and founded the varnish company which bears his name. He is survived by his wife, a daughter and a son.

INCREASES CAPITAL TO MAKE TRUCKS

The Chester County Motor Co., Coatesville, Pa., has increased its capital stock to \$500,000 and plans the construction of a factory for the manufacture of commercial trucks. J. Edwin Brinton is president.

Paint Shop

THE STRIPING OF VEHICLES

The most expert carriage painter will fail to stripe well if he uses a poor or otherwise unsuitable pencil for his particular purpose. A long, supple pencil is to be preferred, with just sufficient hair for the size or width of stripe desired. The pencil should be well filled with color, and be held so that it will be slightly raised at the heel, when using it. The inexpert striper will find a slow color the easiest to stripe with, for then he can easily wipe off and begin anew, if his first efforts prove unsatisfactory, as they most likely will. Also, straight lines are easier to draw than curved ones and the beginner is advised to practice well with curved lines, as well as with straight lines. One of the most profitable kinds of practice in striping is with circles, as this practice teaches the hand to become pliable.

The experienced striper will not, of course, need any instructions along this line, but the inexpert will, I feel sure, writes A. Ashmun Kelly, in *Modern Painter*, be grateful for any little pointers we can give him. Practice makes a steady hand, a confident touch, and, of course, perfect work. The expert striper may almost with eyes shut draw a good stripe, but the other fellow will need all his eyes and wits that he does not go wrong on any sort of line. He will need to remember that by concentrating his attention or gaze upon the pencil he will likely forget to look out for the path before the pencil, and thereby fail to hit the middle of a stroke, let us say. He should not only watch his pencil, but watch where the pencil is going, dividing his vision between the two, and following with his eye an imaginary part along the surface that he is striping.

How to piece out a stripe is another little trick that the beginner needs to learn. When a very long stripe is run the color on the pencil will become exhausted before the line is done, and hence the necessity for replenishing the pencil with color obliges one to take it from the stripe, after which the striping is resumed. Here is where the trouble comes in with the inexpert striper; if the join is not done right it will show the break and look very bad, even crooked. Now, the proper way to resume the stripe is to lay the pencil gently yet firmly down on the stripe, about an inch back from the end where you left off, then press the pencil down until the right width is obtained, when the pencil may be drawn forward and the stripe finished. After some practice you will find this not difficult.

To make a curved line, use the point of the pencil, adding pressure as the curve approaches a straight line, and into which it is to merge. Short curves are to be made with short pencils only, say pencils an inch long. Striping pencils vary in length, I need not state; those 1, 2, and 2½ inches long are for the fine lines, though the last two named sizes answer well for border lines also, say for stripes of ¼ inch and up.

Striping is much less difficult upon a flat or horizontal surface, which is obvious, but then it is not always that one can have such a surface to stripe on. When you have to make a stripe on a vertical surface, or at least on a surface having considerable inclination, the color has a natural tendency to flow into the heel of a pencil, and hence the paint will not flow properly at the point of the pencil. Upon the other hand, striping in a reverse direction, whereby the pencil point hangs down, the color will flow to the point too much. Such are a few of the difficulties the learner will have to face and overcome with perseverance and patience. He should practice with pencils of all

sorts, and also upon all degrees of inclination. Wheel spokes are about the easiest part of a vehicle to stripe; felloes and hubs are difficult. Fortunately, however, hub lines are in such a position that should a line be drawn slightly irregular nobody notices it, but you should be careful about making the ends of the stripes meet neatly. Revolve the wheel quite briskly, and keep your pencil full, having a steady hand. Use the dagger pencil for hubs, as it holds more color and is more supple than other kinds. Give the wheel a turn, put down the dagger, and "let 'er go."

Striping pencils are made from sable, ox, and so-called camel hair. The first two named are more springy, with greater strength of fiber, and do not sag under the weight of the color as the latter does. The beginner in striping will especially like them.

If one is not used to the work, the mixing of the striping color is difficult. It will not run easily, or it may run too freely. It should be made as thin as possible, being merely heavy enough to cover the surface color over which it is applied; also it must flow freely from the pencil.

Take excellent care of your striping pencils. When you are done with them grease with a mixture of tallow and sweet oil, press out into shape, and lay away in a clean, dust-proof box; never plaster them against the window pane. Only barbarians do that. Finally, have a good assortment of striping pencils, as they are inexpensive, and use carefully; they last a long time then.

"OIL—THE LIFE-BLOOD"

Although perhaps a little strong in its terms, the above phrase conveys very well the essentials of an oil paint—the force that is behind. Change your pigment if you wish and according to your lights; use pure turpentine or white spirit. Employ liquid or paste driers as your prejudices or your training direct you; but be true to your oil. It is literally the life-blood of a paint; if it fails, everything else fails. So much for an assertion, now for the practical application without scientific dogma. If a painted surface shows signs of becoming dry under the influence of the sun, give it a coat of pure raw linseed oil mixed with a little gold size; or, far better still, rub it over steadily and thoroughly with a rag generously charged with a similar oil. Does the reader remember the old four-wheel cabs at the time when a slip of silver moulding was invariably introduced for decorative purposes? The old "cabby" would delight in his spare time to polish that thin line with oil and rotten stone, and it gladdened his heart when it shone up brilliantly midst its relatively dull surroundings. But the oily rag did this; it kept alive the surrounding paint work which it touched, and when the main body was perished and done for, the thin line near the silver, which had been fed and sustained by the oil, was still alive and bright. The moral is, of course, that the close application of oil is under certain circumstances, of the greatest advantage.

Painters very rarely apply oil to a surface which is perishing, and if they did would almost invariably put it on with a brush. Try the rubbing on process, and you will probably be surprised and gratified.

One hint more for the practical reader. It may not be new, but it is certainly useful. Did you ever do a job of painted work—oil paint, of course, which, when completed, went dull in patches? And perhaps you were at your wits' end to know what to do. Possibly you realized the fact that the fault was yours, or, at least, the fault of your workmen, in not allowing

for the extra absorption of the undercoat. But whether you do or not, the point is what, under such conditions as those mentioned, is to be done. To give another coat of paint would possibly just turn a barely paying job into an actual loss. What shall be done under such circumstances? Rub hard and rub well with a rag thoroughly saturated in pure linseed oil, with driers as before on every dull spot. If you are a master man, do it yourself, so that you may be quite certain it is done very thoroughly. Then leave the room for 24 hours longer if you can, and take care that there is some ventilation, so that pure air, so essential to the proper drying of oil paint, gets in, and performs its natural function. Your client won't be disappointed, and, most assuredly, you will not.—The Decorator.

HINTS ON WRITING

It must, we think, be conceded that the branch of painting which has to do with lettering and ornamenting of our business wagons and vans has considerably improved during recent years, and the examples of well painted and artistically emblazoned vehicles to be seen have increased considerably. There is no reason, however, why this branch of the painter's art should not be taken up with yet more enthusiasm. With the idea in view of helping the beginner, says the *Automobile and Carriage Builders' Journal*, the following hints on the matter should prove acceptable to our readers, though it must be understood that they are only initial hints. The first lessons should be devoted to sketching with the crayon or lead pencil, and not until the workman has become expert with these should he venture on paint and brush work. When the ability to draw well and to work out original designs has been acquired, the coloring should be taken up. In this, as in other branches of the art, proceed first with straight lines, then to curves, and on to the ordinary letters, doing the full alphabet, and not doing only certain letters which are usually the easier ones. Thus S and O should be well exercised, as these are two of the most difficult letters in the whole alphabet. When the formation of all the letters and figures has been acquired, the workman should set himself to study spacing, for a badly spaced word will spoil the whole effect. A good rule is to place each separate letter into a square, rectangle, circle, or other enclosure, but it must be borne in mind that this can only be followed when the letters are of a similar character and will need much about the same space, but will not answer when I, J, M, W, or V have to be employed, and in such case the workman must make the necessary allowance to avoid overcrowding on the one hand, or, on the other, straggling of the letters. If this is not attended to the eye will be offended, and the effect will be unsatisfactory. With the acquisition of this, designing may be taken up, which, if intelligently pursued, should bring much grist to the mill of the workman, as the artistic painting, lettering, and ornamentation of goods vehicles is a branch of work that has a big future before it.

TO PRODUCE BOTTLE GREEN

A reader asks how to paint bottle green to obtain the deep, rich, lustrous shade so often seen upon New York carriage and automobile panels. Procure, either by buying ready prepared or by mixing with lemon chrome and ivory jet black, a green to correspond as closely as possible with that of green bottle glass. Then with Dutch pink and Prussian blue, ground in japan, mix to a fine, close shade of bottle green. Use the first green as the ground color, the last as the color proper. Apply the ground color with a camel's hair brush. Allow this coat one day to dry. Then dust off and apply the Dutch pink and Prussian blue green, thinned with turpentine to a nice working consistency. This color now gives the proper ground upon which to apply the glazing. Next mix yellow lake in elastic rubbing varnish, using the lake sparingly, and to each pint of the lake glaze add an ounce of the Dutch pink. Beat

the colors in the varnish thoroughly, and flow the surface with the same freedom that would be observed in applying the clear varnish. If a bit of warmth is desired in the green, add a drop of vermilion to the pint of lake. This method produces a green of matchless brilliancy into which the beholder looks with ever-increasing delight.

BURNING OFF A BODY

Few will dispute the fact that to make a thoroughly good and durable job of body carriage painting where the old surface is fissured, and cracked and seamed, the first necessity is to reach bare wood. It seems also indisputable that as a means of reaching bare wood and leaving it in the best possible condition to recoat, the paint burner still more than holds its own. In the hands of the right man, the burning off of a buggy body is but a short operation. The right man is a thoughtful man, known to have "his mind on his work," a man who will not take any unnecessary risks when handling such a mulishly inclined explosive as gasoline can be, though in the right man's hand it is as safe as the fire in the stove.

A man with the "infinite capacity for taking pains" is the safe man to intrust the care and use of the burner to. The man who uses the burner is the man who should care for it when not in use. What care it needs is trifling, but to have it always in condition it needs to be kept clean inside and out, more particularly inside, because if put aside with gasoline in it the fumes will ultimately deposit gummy matter in the flues which will certainly reduce the heating power according to the amount deposited, or enough may be deposited to render it useless until it has been cleaned by an expert. When done with for the day, any gasoline remaining should be withdrawn after cooling off, the plug left out so that air can circulate through the inside, and the whole hung up in such a way that any possible drip remaining may be towards the outlet, and protected from dust.

Not a big job certainly to care for one, but neglecting to care for one may be costly. What we call "burning off," while probably the easiest way to describe what was done, is really a misnomer.

We don't burn the paint off, simply heat it to an extent that makes it possible to get the end of a putty knife or other similar tool between the paint and the wood and by a push leave the wood bare.

The amount of heat required to make this possible is not the same on any two surfaces, owing partly to the difference in the number of coats or layers of paint, and partly to the nature of the varnish the job was finished with. The less paint the harder to burn off clean.

Sometimes it will almost blaze up like tar and nearly liquefy; again it may peel off right along and fall over about as cleanly as ribbon would, and I have seen cases of factory painting, and have just finished on one, where I am convinced it would have been a paying proposition to have given it a good solid lead coat and let it stand over night to dry before burning off. In this case, I would blame it on the foundation or rather the utter lack of foundation, for there certainly never was any on the job to speak of, though it answered the factory's purpose. If only they would not put such unholy finishing on and call it varnish, one might get through such a job without burning off.

One putty knife with a good square edge—and kept square—is about all the tool needed as an auxiliary to the burner on flat surfaces, such as the ordinary buggy body. At its extremities this knife should be slightly rounded, just enough to prevent sharp corners gouging the wood in the proximity of mouldings. When the seat raisers are hollowed, this same tool, if of ordinary width, would be a dangerous thing, but it's easy enough in almost any shop to get a piece of spring steel drawn to the proper thickness and given sufficient curve, very little will be found sufficient, to lie just flat on the surface, and doing

so, may save a lot of gouging and puttying. For the bent Cutter dash, a similar tool should be made, though it should be a good deal wider than one intended for seat raisers. The principal points to aim at in burning off are, to get just enough heat to loosen the paint, prevent all scorching and avoid gouging. The buggy body to be burned off can be in no better position than turned upside down, the seat resting on a barrel.

Of course, if you have a nice handy truck that will support it, it will be better still, for you can swing it to the light any way you need it.

In this position, you can reach every part of a buggy body comfortably, except, perhaps, the upper edge of the seat mouldings, though in many cases you can reach them too, but if not, a few minutes with the body right side up again will suffice for them. In case it is your misfortune to scorch wood, the scorching must be cleaned off down to bare solid wood, or the priming and paint applied to that particular spot will not only be faulty and unstable, but may disrupt the whole surrounding surface. A piece of window glass makes a most effective scraper for such places.

It's usual to say that having a surface burned off leaves the job to be proceeded on just as if it was new, but that is more or less misleading. For instance, no matter how well you may sandpaper after burning, and it's not possible to sand too well, it must be borne in mind that the pores of the wood were once supposed to have been filled, consequently the priming you apply should not be of such a penetrating quality as new wood requires. If you use lead and oil, or ochre and lead and oil, or any such combination, use more pigment than you would on the new job.

If you use any prepared oil priming, don't alter it in any way. Brush on a good coat, and brush it out good, then when you have gone all over the body, inspect it, and you will find that in some places the priming has settled in naturally, just as in bare wood, in others there is sufficient shine to show that the grain of the wood was already filled and it could absorb no more, the shininess indicating that your priming remained on the surface. Take a piece of cheesecloth and rub over the shiny places so as to remove all but a thin film, and your priming will dry equally all over and have about the same thickness of film all over, too. This wiping of the shiny places is sometimes dispensed with on the ground that it has to be sanded anyway, but I think if one fairly considers the matter he will admit that the wiping off way is the best. Nobody, having applied a nice priming coat, wants to sand it any more than just to remove "nibs" and minor inequalities without cutting through, but one could hardly sand the primer on those shiny places unless it had been wiped to the level of the remainder without cutting it into ridges and furrows because of its softness. The same thing would be apparent no matter what priming we applied if only our vision was more perfectly developed, and I have chosen to state the matter this way in an effort to make it quite clear, that while we mostly proceed with a burned off as on a new job, it is only fair to consider it so after its priming has been put right, and unless it is put right and given complete time to dry and harden, the burning off, so far as beauty and durability are concerned, was time and money wasted.

Another peculiarity about a burned off job is that it will need a greater number of coats of roughstuff to rub out to a level surface than new wood and in this connection we may note that where but little roughstuff is to be applied, the deficiency can best be made good by extra care and sanding on the body before priming, and then letting the priming have time to be positively and absolutely dry and hard before working over. Looks like a waste of time to give priming an extra day's drying, but it isn't. Just try it and note the difference in the lustre of your finishing coats, both in the shop and afterwards, as compared with one that was put through on a schedule time that just conformed with the manufacturer's statement on the label of his goods. To make this clearer, say the manufacturer's label states the priming may be worked over in 48 hours, it is

safe to say that the conditions necessary to make that safe cannot be found in more than four or five shops out of every hundred, and many a man today is at his wit's end to account for paint shop deviltries just because he hurried his priming, and quite likely he didn't know it.

CARRIAGE PAINTING NOTES

What is called japan brown color may be made by adding a little vermilion to japan black, just enough to make the presence of the red apparent. This is a very rich brown, and on it stripings of vermilion or orange look well.

Another nice brown may be made with chrome yellow as the base, and adding a little Indian red, French ochre, burnt umber, and white enough to be apparent; the red warms it, and the umber gives it its brown tone. By adding more or less of the leading colors this brown may be varied.

To get a good carmine job, ground the work with English vermilion, making the ground perfectly solid with the vermilion; then grind some pure carmine in a little drying oil, and put in some flowing body varnish; apply the color very carefully. It will take two coats to produce a good solid body. The carmine, of course, makes simply a glaze, having no sufficient body to do otherwise.

Speaking of glazed colors, you can use a green also, as well as carmine, claret, ultramarine, etc. Lay a light green mound, and use a green lake to glaze with.

To make a facing putty for small defects, mix whiting, a little white lead, litharge, of which a very small amount, and japan driers, and a drop of oil; work quickly into a mass, and use at once, as it sets soon. This putty will allow of rubbing down soon after it is laid, and will not tear up under pumice and water.

If you wish a good cheap purple, try mixing vermilion and Prussian blue, adding a very little white lead. Vermilion and black give a cheap plum brown; same for a claret; and looks passably well.

In striping gears, wherever a line comes to a nut head, say, let it go right over or on to it, and then fine lines can follow on or near edges of broad line, and around the outer edges of nut. For a fine effect, run a hair line down the middle of the broad stripe; if the latter is black, run a deep orange, or pure white, or gold stripe down the middle.

Black color-and-varnish should not contain too much color, as all black are poor driers, and when finishing if varnish is applied over a color-varnish containing too much black it is apt to part with some of its luster.

The heavy stripe is not to be advised when painting a business wagon, and it is good taste as well as practice to observe a uniform style of striping throughout the job.

If you have poor success in making your varnish go wrong, throw open your varnishing room to all chance callers, let there be no door to it, let the temperature get low in it, let it get high, don't let it stand still doing nothing—keep it on the move, let the fire go out now and then, open the windows on stormy days.

If you have a case of pitting of the varnish, maybe you have been adding driers to it? That is one of the causes of the trouble, the driers never becoming an integral part of the varnish, but drying in spots, and hence the pitting. Don't do it.

To make a putty for resetting glass in coach frames, add one part of white lead mixed with raw oil to the right consistency, and seven parts of whiting, all kneaded together to make the putty right for working; add a little japan gold size to help the drying of it. If the putty is for black frames, color with drop black. This is said to be a putty that will stay where it is placed.

The Chevrolet Motor Co., Flint, Mich., contemplates establishing new assembling plants in different sections of the country to facilitate the handling of its production.

MEETING OF C. B. N. A. EXECUTIVE COMMITTEE

The executive committee of the Carriage Builders' National Association met at the Hotel Astor, New York City, on Friday, November 13.

Those present at the meeting were President C. O. Wrenn, Norfolk, Va.; Chairman Charles A. Lancaster, South Bend, Ind.; H. B. Staver, Chicago; J. D. Dort, Flint, Mich.; Lewis Straus, Newark, N. J.; W. H. McCurdy, Evansville, Ind.; W. E. Maxwell, Indianapolis, Ind.; W. H. Roninger, St. Louis; P. E. Ebrenz, St. Louis; Theo. Luth, Cincinnati; Thomas M. Sechler, Moline, Ill.; W. A. Sayers, Cincinnati; Homer McDaniel, Cleveland, O.; Secretary Henry C. McLearn, Mount Vernon, N. Y.

Charles A. Lancaster was reelected chairman for the ensuing convention year.

A request from a number of wagon builders that all things possible should be done toward securing a better system of carriage and wagon tracks was next considered. They recommended that the track gauges be reduced to two, one 4 ft. 6 in., and the other 5 ft., measuring from center to center.

The executive committee endorsed this reform and recommended that the members of the association do all in their power to bring about its accomplishment.

The efforts of the Southern Vehicle League were approved and the members of the C. B. N. A. requested to aid in its work as much as possible. A committee of three, Messrs. Theo. Luth, W. H. McCurdy and C. O. Wrenn, were appointed to arrange some plan whereby our members could avail themselves of the work of this league and to consult with the officers of the same.

It was ordered that the report of the Committee on Costs, after being printed in the annual report, be also printed in pamphlet form for distribution to those who wish to avail themselves of the information given; our own members and others, both vehicle builders and accessory manufacturers who request a copy.

As requested by the Federation of Dealers' Associations, a committee of four, Messrs. H. B. Staver, W. H. Roninger, J. D. Dort and Charles C. Hull, were appointed to meet and confer with a like committee of the Federation and endeavor to secure guarantees that would be satisfactory to all.

A. M. Ware, chairman of the Press Committee, presented the report of that committee for last year, with a plan for publicity for the coming year, which was approved, and the thanks of the committee voted for their good work.

Daniel T. Wilson, chairman of the board of trustees of the Technical School, reported on its condition, its prosperity and its great good work it is doing. The usual appropriation was made for the support of the school.

As a suggestion had been made for standardizing one buggy as a sample of what could be done in that line, Mr. Sayers was appointed a committee to report on this as soon as he could possibly do so, in order to see if it is a feasible proposition and would meet with favor.

At the request of the Cleveland members, the date for the convention in 1915 was set for the last week in September.

Arrangements were started for the exhibition and the usual banquet. All the routine matters were considered and the work for this coming year well defined, after which the meeting was adjourned.

PHILADELPHIA VEHICLE BUILDERS' MEETING

The regular monthly meeting of the Carriage and Wagon Builders' Association of Philadelphia was held at the Hotel Hanover on Friday evening, November 20. The principal subject for discussion was "Technical Education," with special reference to the drafting class for vehicle mechanics and apprentices. Messrs. Marbaker, Godshall, Dengeldon, Quirk and others spoke upon this subject.

During this discussion it was brought out that young men who are of foreign parentage, or who have themselves emigrated from European countries, seem more anxious to take up courses of night school studies than our own American-born young men. It was a matter of regret to some members of the association that our young American boys preferred to spend their leisure time in seeking amusement rather than in perfecting themselves in some branch of their trade.

The members of the Philadelphia Carriage and Wagon Builders' Association feel that they are morally bound to support the drafting class, either by assisting it financially through the association, or, better still, in using individual effort to influence more students to take up the course.

It was reported that the young men already in the class are making excellent progress, many of them having completed the preliminary part of their courses and are now studying the practical work.

Following the talks on "Technical Education," which consumed the greater part of the evening's session, the members of the association adjourned to the dining room of the Hanover where an excellent dinner was served. A cabaret entertainment, in addition to the regular musical program, furnished by the management of the hotel, came as a pleasant surprise to the diners.

OVERLAND PLANT TO BE ENLARGED

The Willys-Overland Co., Toledo, O., will add two large buildings to its plant. The first of these is to be 1,000 feet long by 200 feet wide, two stories and basement. The other will be 200 feet square. These two buildings will add practically 17 acres of floor space, giving the company a total of 79 acres of floor space in the Toledo plant alone. It is said that this is a larger area of floor space than is contained in any other motor car factory in the world. The aggregate floor space of this and the affiliated Overland plant operated in other cities is just a little more than 100 acres.

Additions to the Overland plant embodying 25 acres of floor space have only just been completed, and it was thought until as recently as two months ago that with the exception of these additions the plant would be ample for the present, at least.

The larger of the new additions will have an area more than twice as great as that of the entire original Toledo factory when it was purchased by John N. Willys a little more than five years ago. The space will be used for the painting and upholstering departments and the chassis and body assemblies.

Although a building just completed for body assembling and machine work is 400 feet in length and 200 feet wide, two stories and basement, it already has been found too small to accommodate the work. This will be enlarged just 50 per cent.

October was the biggest business month the company ever experienced, it reports. The sales represent a money value of more than \$5,500,000.

SHAW MOTOR INCORPORATES FOR \$1,000,000

The Shaw Motor Co., Chicago, Ill., which recently selected Prairie du Sac, Wis., on the Wisconsin River, as the site for its permanent factory, has filed articles of incorporation and a statement to do business in Wisconsin as a foreign corporation. The capital stock is \$1,000,000 and the Wisconsin interest is given at \$30,000. Contracts have been awarded for the machine shop, office and assembling building, to be 60 x 108 feet in size, 19 feet high, with saw-tooth roof. In addition, the company has the use of the former Kahn foundry for producing its light castings. It is hoped to start operations by February 1, 1915.

A. A. Cooper Wagon Co., of Dubuque, Ia., has been awarded a considerable portion of the \$15,000,000 order for heavy wagons and bob-sleds from Europe recently received by Frederick Fish, of South Bend, Ind.

AMERICAN TRUCK EXPORTS

A total of 784 trucks, valued at \$1,181,611, is the story of America's truck exports for fiscal year ending June 30, 1914. While this is a creditable showing indeed, yet the orders from belligerent nations during the past month have exceeded this entire year's figures by 500 per cent. Conservative estimates place the orders for armored trucks at 3,300 to 3,500 during the past 30 days.

In this connection it might be stated that apparently considerable misapprehension exists concerning the effect of the United States' neutrality status in regard to the selling of merchandise to the belligerent countries. Robert Lansing, acting secretary of state at Washington, has issued an official announcement which should clarify the business atmosphere. This makes it clear that commercial transactions between the warring governments of Europe and private citizens of the United States in no way affect the neutrality of this country, even if arms and ammunition are involved.

The reports of the past few weeks regarding the heavy sales of American motor trucks to England, France and Russia, caused considerable speculation as to the effect of this action on President Wilson's neutrality attitude. In his official statement, Acting Secretary Lansing said: "In the first place it should be understood that, generally speaking, a citizen of the United States can sell to a belligerent government any article of commerce which he pleases. He is not prohibited by international law, treaty provision or United States statute. It makes no difference whether the articles sold are exclusively for war purposes, such as fire arms, explosives, etc., or are food stuffs, clothing, horses, etc., for use of army or navy of belligerent."

Of the \$1,181,611 worth of American motor trucks distributed last year, Canada was the largest customer, taking 247 trucks, valued at \$474,724, and the parent country, England, was second with 203 valued at \$189,099.

It is of special interest to note that the belligerent countries now placing orders for thousands of motor trucks from the United States were very poor buyers during the year. France and Russia, for instance, purchased but two trucks apiece, valued at \$5,070 and \$5,322 respectively. Germany took 24 machines, which had a value of \$18,462. Turkey purchased a single \$2,000 truck.

Aside from the warring nations, it is seen that South America was a fair customer, taking 79 trucks valued at \$130,811. During the current year a great boom in this field is expected, and, undoubtedly, the figures for the current fiscal year, ending June 30 next, will show a considerable gain over the past year.

Taking the individual states of South America, Argentine leads in the matter of American truck imports with 48, valued at \$65,225. This is over one-half of the entire number exported to that country. Brazil and Venezuela are practically tied with 13 and 12 respectively. While it is noted that Brazil surpassed its sister state in the number of trucks imported, Venezuela's imports were of greater value, the amount being \$28,228, as against \$20,449 for Brazil's 13 cars.

While all of the figures are of vital interest to the American truck manufacturer, yet at the present time his entire energies are being devoted to adjusting matters to meet the conditions caused by the European conflict. The war is swallowing up trucks in a manner that is surprising to the manufacturing interests. The allies, according to the closest and most conservative estimates, entered the fray with 40,000 to 50,000 trucks. These trucks are reported as being put out of commission at the rate of 500 a day. All of the latest war pictures show trucks strewn along the road sides, and in most instances where the different armies have been forced to surrender they have blown up the trucks and motor equipment rather than let them fall into the hands of the enemy.

With the plants of France, Germany, Austria-Hungary and Russia either closed down, or were inoperative because of the

lack of workmen, and those of Belgium practically destroyed, it is easily seen that England will be entirely at a loss to supply the enormous demand. Even after the war this demand for American built trucks will undoubtedly still exist, as there will be but few cars that will be in any condition for rehabilitation.

At the present time there are a number of special representatives of foreign powers in this country who are purchasing trucks for the various warring nations. Great Britain has two such representatives in H. G. Burford, M.I., M.E., M.I.A.E., managing director of the Automobile Consolidated Alliance, Ltd., London, England, and Col. Hughes, commander of the Department of Militia and Defense, Ottawa, Canada. Both these representatives are in New York City, and to date have placed orders for 1,000 or more trucks for that country. The American address of the English buyers is Chipman, Limited, 8 Bridge street, New York City. Col. Nicoli Golijoski, representing the Russian government, is at the Vanderbilt hotel, New York City, and to date is reported as having bought some 480 trucks. France is represented by Ambassador Jusserand and Charles R. Flint & Co., New York City, and, according to the latest statements, has taken 2,000 American trucks of various makes.

To the three countries mentioned above it is seen that 3,480 American made trucks have been sold to date. Greece was a recent purchaser of 50 commercial machines, and undoubtedly numerous large purchases have been made, and will be made daily during the war period which will not become a matter of public record. However, whether such purchases are made known or not will not alter the fact that the American manufacturer is reaping the profits.

FORD INCREASES SURPLUS OVER \$20,000,000

The Ford Motor Co., during its fiscal year ending December 30, 1914, increased its surplus over \$20,000,000, the actual figures being \$20,702,859.39. The company started its fiscal year with a surplus of \$28,000,000, so that this added to the profits of the present year gives the company a present surplus of \$48,827,032.07.

During the year, the liquid assets of the company have increased more than 100 per cent., liquid assets being meant cash on hand and accounts receivable. A year ago the cash on hand was over \$13,000,000, today it is over \$27,000,000. Last year the accounts receivable were half a million, this year they are over \$3,000,000, a fact no doubt explained by the great increase in the number of accounts during the past year.

In three years the total assets of the company have almost tripled, totaling \$20,815,783.63 in 1912, \$35,033,919.86 in 1913, and amounting to \$61,632,275.16 in September, 1914.

The total of the surplus for the last three years was near the hundred million mark last September, the exact figures being \$91,696,301.32.

AUTO BODY PLANT NEARLY COMPLETED

The Auto Body Co., Lansing, Mich., has nearly completed a new addition to its plant, the addition being for the purpose of housing the woodworking machinery and making it more convenient to caring for the rough timber stuff that is used in the manufacture of its bodies. The addition will give the company a plant a block long and with an L half a block long. The company has shown a remarkable growth in the decade elapsing since its organization on a capital of a few thousand dollars for the manufacture of automobile and buggy bodies.

GRAMM PLANT ADDS FIFTY MEN

Fifty men will be added to the Gramm motor plant at Lima, O., which follows the announcement that the company has decided to increase the capacity of the plant and only turn out 1,350-pound trucks.

THE EFFECT OF THE WAR ON COMMERCIAL VEHICLE DESIGN

"It is, of course, far too early, as yet, to attempt to draw any very definite deductions which will influence design in the commercial vehicle world and that have been based on the experiences of the present campaign," says Commercial Motor, a London publication. "That the latter have already been many and varied, evidence is constantly reaching us.

"The four-wheeled drive is a type which will receive its final criticism in the present operations, and it is our opinion that it will result in developments of far-reaching importance. Preference as to the use of heavy or light units for military purposes will be definitely ascertainable. There will be a wealth of information with regard to destruction tests which have been carried out as between the steel and wooden road wheel, the chain, worm, bevel and spur final drive, sleeve-valve and poppet-valve engine, leather-cone and disc clutch, wooden and steel frame, and many another alternative method of construction. Of many of these we are in the happy position to be able to keep ourselves very well informed, quite apart from what information official inquiry may render public in the future.

"It is perfectly obvious that, where a government like ours has hitherto been satisfied to have in reserve a thousand or two ordinary civilian-owned commercial vehicles upon which to draw in case of war, vast fleets of more or less standard machines will definitely have to be held at the disposal of the government in future. Few, indeed, foresaw before the outbreak of hostilities the all-important role which was so promptly to be assigned to the motor lorry. We in this country were ready in a way, considering the forces we could put in the field. In France and Germany, with their huge armies, there were none too many commercial vehicles available at the outbreak of war; in Belgium there were practically none at all.

"When peace arrives again at last, despite all assertions to the contrary, we shall not be able to live and maintain our integrity unarmed and unequipped. The final appeal is always to force, and it has to be remembered that there is no effective policeman other than public opinion behind the Hague conference. It is always open to some nation to flout the latter's findings. We shall always, therefore, have to engage in what is more or less the ruinous preparatory competition of armaments. The military motor wagon will be required in enormous numbers in the post-war future. So that on broad lines we can assume that, while as civilians we shall employ as many, or even more, commercial motors than we have in the past, many will of necessity conform more or less to military requirements. The assurance that such a condition of affairs shall follow will have to be enforced by the expenditure of generous subsidies. We shall have to pay for our fleet of motor vehicles as we pay for our fleet of battleships, only, of course, on a very much smaller scale and largely by way of subsidy.

"The first and most important effect on design then, and it is one of the few which may be foreseen quite distinctly, will be that our ordinary commercial models will conform much more closely in future to general military requirements. And for this concession civilian purchasers will secure a quid pro quo. They must be well recompensed."

DEMAND MUST BE CREATED

Before we knew anything about self-propelled vehicles the horse and carriage seemed to be a pretty good sort of conveyance. You could go from place to place with comfort, visit your friends, take drives into the country, and except that you could not go so fast nor so far, could do with a horse and carriage 30 years ago practically the same things that you do with an automobile today. The ownership of a horse and carriage conferred a certain distinction then, just as the possession of an automobile does now. The cost of purchasing and maintaining a horse and carriage then was not greater than the cost

of purchasing and maintaining an automobile now. Why, is it then, says Charles L. Benjamin, in *Judicious Advertising*, 30 years ago there was not the same craze for horses and carriages that there is for the automobile today? Look at the newspapers and magazines of 30 years ago and you will learn at least one of the reasons why. You will look for a long while before you find a single advertisement of horses and carriages. The passive race of business men that preceded the virile race of automobile manufacturers were not advertisers, they made no attempt to create desire, they merely announced spasmodically that they were prepared to supply the demand.

Demand for anything except the necessities of life is not spontaneous; it must be created. The force of example is powerful, but I cannot purchase all the things I see others enjoying, and the purveyor of the things I can do without must tempt me strongly and continually if he would move me to action. This truth applies not only to automobiles, but to everything that is bought and sold. We remain content with the things we have until discontent is implanted in us by some agency outside ourselves.

IMPLIED VEHICLE WARRANTY

Bradstreet's publishes the following item respecting the implied warranty in the sale of a vehicle:

A contract for the sale of an auto wagon called for a vehicle like that shown on a given page of the seller's catalog, and no other description was given as to horse power, etc. On the page of the catalog referred to a vehicle was illustrated, and printed matter thereon recommended that pattern of vehicle for certain uses. The Kentucky Court of Appeals held (*International Harvester Company vs. Bean*) that the description there given became part of the contract, and that failure to furnish such a vehicle as there illustrated and described amounted to a non-performance of the contract of sale and such default as to constitute ground for rescission thereof.

The court said that the warranty of fitness for a particular use which is implied by law, where a manufacturer sells machinery for a purpose made known to him by a buyer thereof, relying on the skill and judgment of the manufacturer in selecting machinery adapted thereto, is a warranty which attaches itself to the contract of sale independent of any express representation by the manufacturer of the suitability of the machinery for such use, attaching by implication of law as a direct result of the communication by the buyer to the manufacturer of the nature of the intended use.

The court added that while, if the parties to such a contract expressly stipulate against all warranties implied by law, none will be imposed against their consent, such stipulation will not be given effect unless fairly made as a part of the contract of sale; that such a stipulation, relieving as it does the manufacturer from duties imposed by law, will be conclusively presumed to have been inserted in the contract for the sole benefit of the beneficiary of such relieving stipulation, and effect will not be given to such stipulation unless its inclusion in the contract of sale was fairly procured.

TO BUILD STEAM MOTOR CAR

Abner Doble, inventor and designer of the Doble steam motor car, has interested Wilmington, Del., capital in his invention and a company will be formed there to build a plant to manufacture the car, a site having already been chosen. Mr. Doble will be president of the company, Col. G. B. Postles, vice-president, and R. R. Wittingham, secretary and treasurer. The company will specialize in trucks. Mr. Doble says there are but 24 moving parts in his new car, which makes its construction easy and not as expensive as other cars. The engine will burn anything from crude oil to gasoline. The boiler and condensing appliance are so perfected that the inventor claims the car will run 1,000 miles without stopping to take water. The scheme of lubrication is such that no oil cups are necessary.

J. G. WENDEL'S DEATH REVIVES OLD MEMORIES

"Fifth Avenue Recluse" Was the Owner of New York's Original "Automobile Row"—The Unoccupied Garage

With the death of John G. Wendel at Santa Monica, Cal., recently, there passed away a character more or less known in automobile trade circles in New York City, particularly among those men who were identified with the motor car business during its early days in the metropolis. Mr. Wendel, who was generally known as the "Fifth Avenue Recluse" or "Hermit," was one of the richest men in New York and owner of considerable business as well as residential property.

It was in connection with his real estate holdings, says Horseless Age, that Mr. Wendel came into contact with the automobile trade, for among his property was the block bounded by Seventh avenue and Broadway, Thirty-eighth and Thirty-ninth streets and the northern half of the block just below, including the entire Thirty-eighth street frontage. When the automobile first made its appearance in New York to any extent the men handling the new vehicles concentrated their showrooms and offices on the Thirty-eighth street property owned by Mr. Wendel. This was the original "Automobile Row" in New York, the scene of the early operations of men now nationally prominent in the automobile industry.

The old "Thirty-eighth street Row" holds some fond memories to many now in the trade. It was here that Peter Fogarty and E. B. Gallaher startled the business world by decorating their showroom with rugs, palms and other floral pieces, now common in automobile salesrooms, but very radical in those days. Fogarty and Gallaher handled the old Northern car. Among their neighbors were R. M. Owen, just starting in the business then with the Oldsmobile and Franklin; Charles E. Miller, the accessory man; Banker Bros., with C. C. Wridgeway as manager of the sales of St. Louis cars; F. A. La Roche, formerly of Hudson street, with the De Dietrich and Darracq; Smith & Mabley, Inc., handling the Panhard, Mercedes and Renault, as well as the S. & M. Simplex, the original of the present Simplex; Count Goutrand Biron with his French electric; the Standard Motor Co., which handled the sales of the Decauville car, the car that became famous in its way because it was made abroad especially for American consumption. There were a number of others prominent in their days as members of this thriving colony of motor car dealers, but the above were the most conspicuous of the group. Mr. Wendel's death also brought back to several men still engaged in the automobile business along the new "Row," thoughts of the day when the Hotel Navarre, at Thirty-eighth street and Seventh avenue, was the scene of the daily motor luncheons and particularly of the sign printed in Latin, which adorned the dining room of the hotel and well indicated conditions in the trade which cautioned the dealers: "Leave your hammers behind, all who enter here."

Mr. Wendel was noted for his eccentricities, even in the early days of the automobile business in New York, and because of his steadfast rule not to improve any of his property the automobile concerns had to move to more modern quarters. About the only exception to his rule against improvement was about eight years ago, when he erected a four-story garage on the northwest corner of Fiftieth street and Broadway. It was splendidly constructed and even now compares favorably in appearance with some of the up-to-date showrooms on Broadway, but it never had a tenant. Several times it was almost rented and Broadway had connected almost every man of prominence in the local business with an effort to lease the property. As far as the automobile men were concerned, the property was ideal for their business, but Mr. Wendel's peculiarity of opposing any move that might modernize the building prevented its being leased. It is reported that one automobile dealer after agreeing with Mr. Wendel's agents to rent the building for \$25,000 a year mentioned the placing of an electric sign on the

face of the building when he met Mr. Wendel to close the contract. "I never allow anything of that sort on my property," said Mr. Wendel, and the \$25,000 annual lease was not signed.

The large, square brownstone and red brick residence on the northwest corner of Thirty-ninth street and Fifth avenue was characteristic of the man. No one ever saw the windows open to let in the sunshine and fresh air and the shades were invariably drawn. Adjoining the house is a large yard, the largest vacant plot on the avenue, south of the upper residential section. A high board fence shuts it off from the street. It is said that he refused an offer to sell the property, worth a million dollars, because it would deprive his sister's pet dog of its playground. When Mr. Wendel died he owned real estate worth over \$55,000,000.

EDISON "STARTS OVER AGAIN"

Witnessing at the age of 67 the destruction of his great workshops, Thomas A. Edison exhibited true American spirit when he said to the reporters: "I'm pretty well burned out just now, boys, but I'll start all over tomorrow. There'll be some rapid mobilizing here when this debris cools off and is cleared away. I'll go right to work to build the plant over again. It is just a temporary set-back; don't forget that."

There never would have been any Thomas A. Edison such as the world knows if the bearer of that name had yielded easily to reverses, but his courage in the presence of disaster late in life is none the less noteworthy. No one need imagine that a man of such triumphs has not also been profoundly schooled in defeats. It is this habit of years which now fortifies him against adversity.

We know of no habit that is better worth cultivating. Nearly all human endeavor is attended by more or less failure or misfortune. There are many who never surmount their first affliction. Most of the comparatively few who gain great success have "started all over again" many times.

The industry, perseverance and self-discipline of Mr. Edison have long been an inspiration to the young men of America. During all these years he has created something besides electrical appliances, and quite as important—he has been building character. It is character that enables him in old age to meet frowning fortune undismayed.—N. Y. World.

BRITISH FACTORIES BUSY

Taken as a whole, the automobile industry in England has been rushed as the result of the war. Practically every branch of the manufacturing end of the trade is working day and night in order to keep abreast of the rush orders due to the conflict. Nearly every British truck, automobile, tire or accessory manufacturer is handling the government's work and finds it difficult to fill these orders without taking on any additional work.

The rule adopted by manufacturers throughout England in regard to the labor problem is an extremely fair one. Notices have been posted in all factories to the effect that the positions of the men who enlist will be kept open for them and work will be guaranteed them on their return from the war. In the meantime the companies are providing for the dependents.

McINTYRE DENIES RUMOR OF NEW SIX

The rumor that has been floating around in automobile circles to the effect that the McIntyre Company, of Auburn, Ind., was soon to put on the market a new light six selling completely equipped around the \$800 mark is absolutely without foundation, according to President W. H. McIntyre. He says: "We are working our limit on the new McIntyre 25 at \$695 recently announced, which seems to be the car a great many people have been waiting for—to even consider a six in the midst of our present rush is absolutely absurd."

PROBLEM IN FINANCING EXPORT TRADE TO SOUTH AMERICA

In discussing the outlook for more fruitful trade relations with South American countries, and the most promising methods open to American manufacturers for building up permanent sales fields with our neighbors to the south, Dun's International Review for November makes the frank statement that the success of such a campaign depends entirely upon satisfactory credit arrangements. It is pointed out that shipping conditions, as applying to South American countries, are not to be complained of at present and that there is a reasonable demand for standard United States products; the hitch, if there is to be one, lies in the financing of our trade with the Latin-Americans.

It soon became apparent, says Dun's Review, in analyzing the situation, "that it was not lack of shipping facilities that was retarding the resumption of trade relations between neutral countries, and particularly between those on the western hemisphere, but the extraordinary difficulty of financing shipments.

The United States quickly demonstrated that its financial position was sufficiently strong to take care of all the requirements of its domestic commerce and its import trade, but it became increasingly evident that its sister republics to the south were not equally fortunate. Every one of these was suddenly confronted with an enormous shrinkage in its buying power, owing to the loss of the normal European markets for its staple export commodities. The commodities thus affected were not the same for all countries, but the situation was identical—the war had cut off the usual outlet and each country found itself unable to sell the major part of its products. Prices of all the Latin-American staples fell in consequence, exactly as the price of raw cotton has fallen in this country. Each country found itself with these staples on its hands—for the most part foodstuffs and crude raw materials for various manufactures—but no money and no means of converting the staples into money.

From this it followed that the mechanism of international exchange, by means of which these countries in normal times were accustomed to pay for their imports, immediately broke down. For more than a century, or ever since the various Spanish-American countries ceased to be colonial dependencies of Spain, it has been customary to make export shipments from these countries and their great sister republic of Brazil the basis for credit balances at London. The reason for this was the fact that such balances, being in pounds sterling, could be drawn against to settle accounts for merchandise purchased from any country in the world—the pound sterling being, as Mr. John E. Gardin has aptly expressed it, "the common denominator of international exchange." In recent years there has been a growing tendency to create similar credit balances at New York, but these have been smaller than those at London, have been made in favor of only a few countries, and have usually been available as a basis for drafts upon a relatively small number of concerns. Direct exchanges between the United States and Latin America upon the basis of the gold dollar as the standard unit of value has, therefore, been restricted to a comparatively small part of our transactions with those countries, and the customary procedure has always been the triangular one by means of which Latin America drew against balances at London for whatever it sold to the United States, and this country drew against London for its shipments to Latin America. The breakown of this triangular exchange as a result of the war affords an opportunity to attempt the substitute of the dollar in place of the pound sterling as the basis of exchange between the United States and Latin America, and a straight line from New York to each Latin-American capital as the exchange route in place of the traditional triangle via London.

Obviously, this is merely an opportunity—a possibility of the future, not a reality of the present. If the war proves to be a short one, as every American devoutly hopes that it may, the

displacement of the roundabout pound sterling exchange route by the direct dollar exchange route will be at best only partial, and may prove to be only temporary. On the other hand, if the war should be protracted—as many of the leading authorities among the principal belligerents appear to expect—the advantages to all parties concerned will be so great that every effort will no doubt be made to establish the dollar as a new "common denominator" in Pan-American exchange. This will not mean doing away with sterling exchange, or attempting in any sense to do so, but will be simply a concerted effort on the part of the various countries of North and South America to provide a new exchange channel to supplement that of London, and to furnish a medium for continuing business between these countries in emergencies.

Since the outbreak of the war American manufacturers, bankers and transportation interests have been studying the Latin-American trade situation more carefully than ever before. The most important and constructive report on the subject yet published is the one prepared by the Latin-American Trade Committee of the National Foreign Trade Council appointed by the Honorable W. C. Redfield, Secretary of Commerce, early in September. This report was issued October 19. Its important constructive recommendations relative to the financing of Latin-American trade may be summarized by the following extracts:

"Even before the war our export trade to all Latin America, and notably South America, had begun to decrease on account of the prevailing financial stringency. Our imports, however, increased in value, and the trade balance adverse to the United States for the fiscal year 1913-14 greatly exceeded that of 1912-13 both for all Latin America and for South America alone.

"Since the balance of our trade with South America is heavily against the United States, there should be exchange facilities which would enable our exporters to obtain payment from balances created in New York in settlement for goods imported into this country from South America.

"Such balances, however, are not maintained in this country.

"Our exports to, and imports from, Latin America are shipped direct. They are, however (almost exclusively in South American trade, and largely in Central American trade), paid for in sterling bills of exchange.

United States exporters have, in the past, converted their dollars into sterling at the rate of the day, drawing against their South American customers at 90 days sight, payable in 90 days bills on London. Importers have accepted 90 days sterling bills, which they have liquidated at the current rate of exchange. This has necessitated the conversion of dollars into sterling in the United States, and a re-conversion in South America from sterling into the currency of the buying country.

"Thus, although the balance of the South American trade of the United States has been increasingly heavy against this country, we do not make settlement direct. We have been obliged, either by the shipment of gold or goods, to settle this adverse balance by remitting to England either gold or goods, to meet interest charges on the South American debt, and to pay for goods purchased in Europe by the South American countries.

"Old methods may no longer be serviceable in the situation which will result from the readjustment following the war. It should now be possible indeed, in the mutual interest of the Latin-American republics and ourselves, to create new credit machinery to perform the functions of the old, and which will at the same time rid us, at least partially, of a dependence upon the London credits and European financial markets which, though essential in the past, has proved to be seriously embarrassing.

"Whenever there is a great disturbance of the world's finances, American exporters and importers in South American trade are injured, because of their dependence on London. This has happened four times in 25 years.

"So long as South America must meet interest settlements in London by shipment of goods to the United States, under

WHAT IS A WAGON MAKER?

Is the term wagon maker applied to a wagon repairer as the term watch maker is applied to a repairer of watches, or does a wagon maker actually make wagons?

"The term wagon maker means all that it implies," said Austin English, of Hutchinson, secretary of the State Association of Blacksmith, Horseshoers and Wagonmakers, which was in session in Wichita recently.

"About 50 per cent. of the members of the association are wagon makers. The majority of these limit their manufacturing to a wagon bed once or twice a year and then only on special orders.

"We do have members who do nothing but manufacture wagon, carriage and automobile bodies. These are the real wagon makers. One of our members from Newton makes a specialty of taxicab bodies and does neither blacksmithing nor horse shoeing.

"Of course a wagon maker does not attempt to manufacture the running gear of either a wagon or an automobile. That is all machine work and there is no manufacturer in the United States today using hand labor who can compete with factories which use machinery for turning out running gear. Hand labor can never compete with machine labor.

"That is the reason that the wagon making industry has come to mean only the manufacture of wagon and carriage bodies. Hand labor can still compete with machinery in this work, because a machine can never duplicate the delicate work done by hand. Until some machine can be found that will put a wagon body together much better and cheaper than can any machine we have today, wagon makers will still be wagon makers and not merely wagon repairers."

AMERICA AND THE EUROPEAN WAR

From general information received by the writer in private letters, it seems that the German rubber industry was fairly active during the first months of the war, and, considering the enormous demand for war materials and the influence rubber has on many industries connected with the production of such supplies, it appears that the demand for rubber manufactures will continue—at least as long as Germany can keep the enemy outside her boundaries. The rubber industry in England is certainly as busy as it is in Germany, and its opportunities are greater. England can add to the demand from her own war office the considerable amount of private business done by Germany before the war, provided her industry is able to replace German goods in quality and price, writes Ludwig W. Schmidt, in *India Rubber World*. Little definite information has been obtained regarding the French rubber industry, but it can be surmised that the works which are interested in the manufacture of war material will be kept busy.

Under these circumstances it is clear that the demand for raw rubber must be very large. Germany cannot get new supplies. It has, as far as can be ascertained, large quantities of raw rubber in stock, which, however, must some day be exhausted; and it is an interesting problem what Germany will then do. It is very likely that her reclaiming industry is already supplying that part of the demand which until now has been supplied by American reclaimers. It is impossible to say whether any amount of reclaimed rubber is still leaving this country for Germany. If so, the quantity must be small.

Everything, therefore, points to the conclusion that at the end of the war stocks in raw material as well as in reclaimed rubber will be small, and that large replenishments will have to take place. It is impossible to say what the end of this conflict will be and what the economic situation in the warring countries will be at its conclusion. However, it seems practically certain that a new and strong demand for raw material and reclaimed rubber will arise as soon as normal conditions have been restored. This will materially affect the American

reclaimer. The European field has been a very good one for him in the past and there is no reason why it should not again be as satisfactory. Of course, it will take some time to resume old relations, and confidence will be shaken. Nevertheless, it would be bad policy to let the war interfere with development of business in Europe. The markets of England, France, Germany and some of the other countries are closed, but those of Spain and Italy remain open and it is to be hoped that these nations will be able to maintain their neutrality. Both these markets can be entered successfully by the American reclaimer, and it would be advisable to take steps at once to develop this export business, while Russia, one of the largest producers of reclaimed rubber, is greatly hampered in her movements and the Russian industry suffering in consequence. Having secured a foothold in these two markets, it will be much less difficult to resume business relations in the older markets when peace is restored than it would be if relations had been entirely cut off.

Incidentally it may be remarked that, as a result of the war, there will not only be a large demand for reclaimed rubber, but in addition to this there ought to be an increase in the supply of waste rubber. Whether this will be of the first class, of course, is doubtful. War waste as a rule is not of the highest grade, but the cessation of collection during the past few months will bring in its wake a larger volume of material, which ought to benefit the reclaimers in the United States. It seems probable, therefore, that the war, while at the moment stopping the business of the American reclaimer in Europe, will not injure it permanently. On the contrary, a large demand can be expected when normal market and manufacturing conditions are restored.

URGES USE OF SAFER APPLIANCES IN HAZARDOUS WORK

In an address on "The Engineer and His Relation to Accident Prevention" before the Engineers' Club, C. M. Hanson, chief engineer and secretary of the Workmen's Compensation Service Bureau of New York, urged upon the engineering profession the duty of safeguarding the employe by the development of less hazardous processes of production, the designing of safer appliances and by the education of the users.

"A careful analysis of hundreds of thousands in this and other countries," said Mr. Hanson, "disclosed that approximately 20 per cent. of all industrial accidents is due to defective and unguarded machinery and appliances; 30 per cent. to inherent carelessness, recklessness and disobedience of rules and regulations on the part of employes; 40 per cent. to inherent hazards in the various industries. This 40 per cent. will continue to occur as long as the present methods of conducting industries are in vogue. Immediately, however, that safer methods of operation are introduced in any industry, the total percentage under that heading will be proportionately reduced. The remaining 10 per cent. of all industrial accidents we have never been able to segregate under any particular heading. They are due to all causes combined. No particular party can be held responsible."

GRAMM-BERNSTEIN TO BUILD TRUCKS FOR GOVERNMENT SERVICE

The Gramm-Bernstein Co., of Lima, O., has booked an order from the federal government at Washington, D. C., for 25 trucks to be used by the various departments. They will be used in the District of Columbia only.

TRI-STATE SHOW DATE

The next annual convention and exhibit of the Tri-State Vehicle and Implement Dealers' Association will be held in Cincinnati, O., October 15 to 20, 1915.

PLANTATION RUBBER INDUSTRY AND THE WAR

According to a communication from M. N. Le Coispellier to the "Annals of Indo-China Rubber Planters," the rubber trade, in common with business in general, was surprised at the sudden breaking out of the war in the closing days of July last, when sales ceased in the east. Penang and Singapore held their last auctions previous to the war on July 28. They showed a lack of activity under the influence of the European cables, which left but small hope of maintaining peace. Sales were resumed rather timidly on August 12. The last sale before the war was held at Ceylon on July 31, when the situation was such that the principal sellers withdrew their offerings, some private sales being afterward made at prices equaling between 48 and 49 cents (American currency) per pound.

On the suspension of sales the planters of the Malay Peninsula lost no time in devising plans for meeting the situation. Messrs. Skinner and Macfadyen, former and present presidents of the Planters' Association of Malaya, went to Singapore to call the attention of the government to the prospective effect of the altered conditions on the plantation industry. A general meeting of the association was also held August 6, at Kuala Lumpur, to discuss the steps to be taken.

After an ineffectual attempt to obtain the co-operation of financial institutions, an arrangement was made by which both in the Federated Malay States and in the colony of the Straits Settlements the respective governments would make cash advances to the estate owners for the purpose of at least feeding the laborers, while official intervention would be used to persuade the latter that it was in their interest to remain on the plantations on the terms which would be offered them.

To cover these advances the government would receive consignments of first quality rubber, on which advances would be made at a rate equaling about 18 cents American currency per pound, or listed securities. In certain special cases loans would be made on personal guarantees. The requirements of the Federated Malay States for making these advances in money or rice were met by the help of the Straits Settlement colony, which took over shares from the Federated Malay States, which it would have been difficult to sell in present conditions, but which the colony was in a position to handle, having acquired a considerable stock of gold.

The principal anxiety of the planters was lest they would be unable to retain their coolies (estimated at 270,000), hence addresses were delivered in the various districts urging the laborers to accept the temporary conditions offered them for keeping the estates in good shape and doing a small amount of tapping.

According to M. Le Coispellier's statement, a large number of estates on the east of Sumatra belonging to English and German planters decided to cease operations, leaving to their own resources their 30,000 to 40,000 coolies, who were obliged to return to Java.

The efforts made on the Malay Peninsula to open up new outlets for rubber, in order to replace those closed in Europe, are spoken of as being all the more opportune, as there is a certain slackening of the English rubber industry and almost a total cessation in France, Belgium, Russia, Austria and Germany.

It is added that the horizon is becoming clearer for the rubber industry in general, and particularly for producers, the maritime commercial routes remaining free, which enables the raw material to be brought in security to the markets. The unprecedented consumption of rubber for the pneumatic tires of automobiles for military purposes will alone form an important outlet. This situation, the planters believe, cannot fail to react on the price of the raw material, all the more as, owing to the uncertainties of the opening of the campaign, a slackening of production took place which may lead to a scarcity of product. The hope is expressed that the reaction will not be sufficient to bring back low class wild rubbers to consumption. Had planta-

tion rubber not continued to reach the markets, manufacturers would have tried to promote the cultivation of lower grades in Brazil.

Regarding the Indo-China plantations M. Le Coispellier remarks:

"The question of labor not having to be met at present, our policy should be to continue as we have begun, so as to be ready to benefit by the increase of price which will certainly take place in Europe after the war, when the rubber industry there will be revived—pacified for a long time to come."

TO DEFEND KARDO PATENTS SUIT

At a meeting of the National Automobile Chamber of Commerce at headquarters in New York, on Thursday, December 3, it was decided that the national organization of automobile manufacturers will take over the defense of the rear axle patent infringement suit instituted against the Studebaker Corporation by the Kardo Co., several weeks previous. This decision means that the N. A. C. C. will take definite action against any move that the patents holding company might make toward demanding royalties for their patents from members of the N. A. C. C. In a statement furnished when the Studebaker suit was begun in Chicago on November 12 the N. A. C. C. declared that it had made a comprehensive search in preparation for any aggressive movement of the Kardo Co. to exact tribute from the automobile industry on the "eight or nine patents which it has secured from inventors with a view solely to secure revenue and not with the thought of protecting its product." The chamber announced then that it had retained the ablest counsel to defend its members from attacks by the Kardo Co.

The Kardo Co. was organized early in 1914 by the Packard, Peerless and American Ball Bearing companies, owning several patents covering the construction of rear axles.

CARRIAGE AND AUTO TRADE IN JAVA

The trade in American carriages with Netherlands, India, amounted to \$20,000 during 1913. This business has been pretty evenly divided between Java and other parts of the colony; in fact, American carriages are in favor with the planters in Java, as well as in Sumatra, Borneo, and the Celebes. The total imports of carriages during 1913 amounted to \$70,000. Besides the United States, the principal countries supplying this trade are Great Britain and the Netherlands.

There was a satisfactory business done last year in American automobiles, and statistics, together with other information received, show that 250 American cars, valued at \$250,000, were imported during the year, as compared with \$86,600 for 1912. The total number of automobiles imported was 1,260, valued at \$1,638,000.

Figures show that 490 cars were imported from the Netherlands (it is doubtful if all were Dutch cars), 250 from the United States, 112 from France, 105 from Germany, 80 from Great Britain, 60 from Belgium, 40 from Italy, and 50 from Singapore.

At the close of 1913 American automobiles were well represented throughout Java and a large business was reported. Forty different makes of automobiles are on this market at present, among which the writer has seen 13 American makes.

Automobile accessories not including lamps were imported into Java to the value of \$126,445, of which only \$8,637 worth came from the United States.

BOND ISSUE RETIRED

The Staver Carriage Co. paid on October 1, 1914, the final instalment of a bond issue of \$100,000, secured by a deed of trust on its plant. The deed of trust has been released, leaving the factory property free of incumbrance. The money obtained on this bond issue ten years ago was used in enlarging the plant and increasing the business.

FAILURE OF ROAD BOND ISSUES

Instances are not lacking, according to the road building specialists of the Department of Agriculture, where bond issues for highway purposes have proved failures. These failures, the government experts say, are invariably due to mismanagement rather than to defective principle. Where counties have issued highway bonds the proceeds of which have been spent to construct temporary road surfaces on unimproved grades and without proper drainage, failure has necessarily resulted. There are on record in the Office of Public roads instances where so-called macadam roads have been built with bond money by simply dumping broken stone at the wrong time of year on muddy road surfaces without grades or alignments and without rolling or binding.

A typical method of mismanagement is to distribute the funds equally on all the roads in the county or district issuing the bonds. Recently in a southern state \$40,000 was distributed equally over nearly 90 miles of highway in a certain district. After deducting necessary overhead expenses this sum was equivalent to about \$400 per mile. Obviously no permanent results could be obtained from such a distribution. In another county, where heavy rains and severe winters could not fail to make the roads nearly impassable with the superficial construction adopted, bonds were issued to the amount of \$300,000. The money was devoted to light grading on an excessive mileage without any attempt at surfacing.

Through a misunderstanding of the essential principles underlying the establishment of a proper county road system, conflicts of interest sometimes arise which cause the failure of the bond issue plan. The location of the roads to be improved should not be determined by argument, but upon sound engineering and economic principles. Before a community votes to issue bonds for highways it is necessary to understand thoroughly what roads are to be improved, and the approximate cost of their construction and maintenance. Too frequently ill-advised locations are adopted.

Need for Highway Engineers

Highway plans for bond issues require expert skill and professional service. Before the amount of bonds is determined, a thorough study of the needs of the county should be made and careful maps of the proposed highway system should be prepared. The sum to be issued should not be fixed until it is reasonably known what it will accomplish. It is customary for many counties to appoint a commission of business men under whose jurisdiction the bond money is expended. In other cases the county supervisor or county commissioner has the direction of expenditures. The best results have always followed where such commissions or county boards have secured the services of a highway engineer.

Guided by the costly experience of many communities, it is now becoming common for counties to adopt this plan. In all engineering construction it is customary to allow a certain percentage of the cost for engineering and supervision. There is no reason why highway building should be made an exception to this rule. At least 5 per cent. of the bond issue may well be set aside for engineering and supervision alone. Money spent to hire a competent engineer to make preliminary investigations before bonds are issued and to plan and supervise construction will be well spent. It is not uncommon to find counties that will repeatedly postpone the sale of bonds in order to obtain an increase of 1 per cent. in a bid for \$100,000 or less and then proceed to construct the roads in a most haphazard and ill-planned manner.

GOODYEAR TIRE CO.'S PROFITS

The annual report of the Goodyear Tire & Rubber Co. for the year ended October 31, 1914, shows net income of \$3,391,000, out of which was paid 7 per cent. dividend on the preferred stock and 12 per cent. on the common. The earnings were

equivalent to more than 36 per cent. on the common stock. In its balance sheet the company makes an excellent showing, with current assets of \$11,039,000 against current liabilities of \$668,000. During the year the slate was cleaned of notes payable aggregating \$3,653,000. As usual, Goodyear carries its patents, trademarks and designs, or "good will" on its books at \$1, and all the figures on the asset side are real, tangible values. Cash on deposit and on hand has increased from \$1,141,000 in 1913 to \$2,862,000 in 1914, or more than 150 per cent.

The stockholders reelected the directors and the officers of the company were also reelected. President Seiberling, in his annual report, shows that the company enters 1915 with greater strength and with brighter prospects than ever before.

ADDRESSES AT LATIN AMERICAN TRADE CONFERENCE

A pamphlet giving the statements made by representatives of Latin-American countries at a trade conference with American bankers and business men in Washington, September 10, has been issued by the Bureau of Foreign and Domestic Commerce and is available for general distribution. The conference was called by the Secretary of State and the Secretary of Commerce to obtain a clear statement of the commercial needs of both the United States and the Latin-American countries and the facilities for co-operation in supplying those needs. The statements made by the Latin-American representatives set forth the conditions in their respective countries and the particulars in which the assistance of interests in the United States is desired. The opening statement by the Hon. William J. Bryan, Secretary of State, and an address by the Hon. William C. Redfield, Secretary of Commerce, are also included. The pamphlet may be obtained from the Superintendent of Documents, Government Printing Office, Washington, D. C., for five cents.

TIMELY WARNING

President John E. Wilder, after the luncheon of the National Tanners' Association meeting, held in Chicago on October 30, referred to the unprecedented conditions involved in the great war in Europe. We get 50 per cent. of our supplies abroad, which the war cut off. Previously, in America, leather production had been curtailed and shoe manufacturers had also curtailed. The war will need vast quantities of leather which is one of the most important needs of warfare. After war broke out English bends advanced from 14c to 16c per pound. Bellies went up 5c per pound. All heavy sole and upper leather in America has been sold for export to the end of this year. Mr. Wilder warned the tanners that stoppage of the war might be followed by cancellation of leather contracts, and urged non-cancellation clauses and great caution used in selling leather to the foreign armies. He stated that much leather made for the Russo-Japanese war in 1904 was left on tanners' hands, and had been sold recently to Europe. This leather was ten years old. He hoped tanners would not be caught similarly by the sudden termination of the present war. This led Mr. Wilder to advise that regular customers be taken care of, as they would be taking leather long after the present war is over.

GETS ORDER FOR 7,000 WAGONS

The Kentucky Wagon Mfg. Co., of Louisville, Ky., is reported to have received orders for 7,000 wagons—4,000 in one lot and 3,000 in another. These orders are not from Europe. The receipt of these orders is recognized in Louisville as an indication of the rapidly improving conditions of trade throughout the country. Other large orders, some of them from Europe, are expected to be placed with several Louisville houses within the next few weeks.

COST ACCOUNTING

Taking as his subject "Cost Accounting—Its Particular Application to Your Business," J. A. Craig, of Janesville, Wis., addressed the Illinois Implement and Vehicle Dealers' Association, at Peoria, December 3, as follows:

I was told by one of your number that I had a very dry subject to present to you and I grant such is the case, if I would attempt to present it in the abstract form of simply how you can make it a part of your system of accounting, but this is not my plan in discussing this important subject with you. However, I do not want you to think for one minute that I do not realize the value of a competent system in cost accounting and the absolute necessity of every one in business today knowing their costs; the importance of having all in the same line of business figuring their costs on the same basis, and to be sure to include in them certain fixed expenses that must be accounted for, even if the actual money is not paid out each year.

What I am referring to is interest on investments, depreciation on stocks, allowance for losses, salaries for the proprietors and rent, even if one does own their own buildings in which they are doing business. Unless we all figure on such items as these you can readily see there is liable to be a great variation in our costs.

A few days ago I had a man say to me that his expense budget this last year was only \$4,000 and, knowing that there were two men in the firm, I asked him how much he set aside for salaries, and I found he was not figuring on any at all. You can readily see that an item of salaries for a firm of two persons, depreciation on stock, interest on investment and a reasonable amount set aside for losses, would make a budget of this size, or more, to say nothing about all the other actual expenses that one would pay to conduct their business—hence the importance of having an established system of accounting, and all working from the same basis; but, as I said in the beginning, I am not here to discuss that side of the question with you this morning.

Primarily, what are our costs for?

(a) First and foremost of all, I should say, to enable us to make our selling prices, for how can any intelligent person determine what they must sell their goods for unless they make up their selling prices from their costs? A little later on I am going to have more to say about this question of selling prices.

(b) I should also say that our costs were to determine the limit of our selling expenses in relation to our volume of business, for you all realize how easy it is to increase your volume, especially in a year like this, that you have had here in central Illinois. Your costs act as a barometer to keep these two balances equalized.

(c) Another thing that your costs are good for is in the proper selection of your line of goods that you will sell. First, there is the quality. Next, as to the variety, as that is getting to be one of the important things that implement dealers of this country must pay more attention to. Too many dealers fail to keep adding to their line the new things that are placed on the market that rightfully belong to them and, naturally, after some other kind of a merchant in their community has introduced the goods, they find they are cut out of the sale of them.

(d) The next thing that your cost system will show you is the amount of stock that you should carry in proportion to the volume of business you are doing. If the dealers here present this morning had the capital that they have tied up in dead stock at their command you would not be so much concerned about your collections or your ability to meet the payment of your bills when due. I am convinced that the stock of goods carried by dealers here in Illinois, as well as elsewhere, could be reduced from 25 to 33 1/3 per cent. if more care was exercised in the selection of their stocks. Your cost sys-

tem will show the expense of carrying stocks of goods. Take, for instance, an article that cost you \$50, carried one year costs you \$3 for interest, and unless very carefully stored, your depreciation will amount to another \$2. Allow this to run for five years and you have one-half the original price of the article added to your expenses—so really in place of selling carried-over goods at reductions they ought to be sold for more money which, of course, we know is an impossibility to do.

(e) The next question your costs will determine, and that is the terms at which you can sell your goods. A proper system of accounting will show you how much money you have tied up in capital, stocks of goods and notes and accounts, and in place of selling goods on unlimited time and trusting to good fortune to have the money to pay your bills with coming from some other source, you will know what terms you can make in selling your goods and will answer the question which is often asked very plainly, who is to be the banker for the farmer in your community?

(f) Your costs will show the service you can furnish free. In other words, it will determine very clearly the dividing line between service and expense, which, I fear, some of the dealers today are somewhat in doubt about.

(g) A thorough cost system will show very clearly the number of dealers that a community will support. Remember this one thing, there is a limit as to the amount of goods that can be sold in each community of a given class. I fully appreciate, however, that in most communities trade is not brought up to the maximum, but I also realize that in some towns there are entirely too many dealers for the amount of business that can be secured, and unless one has a cost system that is reliable there is liable to be several failures before they discover what's the matter.

(h) Another thing that a cost system will do is to show very clearly whether the business will support one, two or three partners, which I fear many times is not carefully considered by men going into business.

(i) Another question that is frequently asked at conventions is, "Does it pay to canvass or deliver goods out on the farms?" The answer to these questions will show very plainly in your cost system. Another question that is agitating the minds of dealers today is in reference to territory. The whole question of profitable prices, amount of goods that you can buy, the volume of business that you can do, and the amount of your annual expense, is very largely summed up in this question of the territory, and instead of debating the question with the manufacturer as to the probable size of your territory, let your cost accounting system tell you that, and then you will be playing on the safe side. Another question you very frequently hear discussed today, and that is, "Conducting the business on a cash basis," which does not seem to be practical; or "Selling goods on shorter time and taking note settlement at time of delivery." These questions are wholly answered by a competent cost system, which will show you what you must do in this matter and not what you ought to do.

(j) Also a competent cost system will show you the profitable lines to push the sale of. One of your own number, Mr. Derry, has a system that gives him his information, and I have several times heard him explain it before dealers' conventions. The advantages of knowing the profitable goods to handle and what you should be pushing the sale of, simply means the difference between success and failure, in many instances.

(k) Your cost system will guide you in the amount of extra help that you can afford to hire during the year and also the price that you should pay. This is a very blind subject with most of the dealers, and oftentimes they spend money for additional help during the rush season that may mean taking all the profits there were in the business that year.

(l) Last of all, what a cost system will do for you is to show you when you should get out of business. Now this may be rather a hard statement to make, but it's nevertheless true, that there always comes a time in the experience of every in-

stitution when you have either got to strengthen your organization or else you are going to see your business gradually slip away from you, and one of the most pathetic things that a manufacturer has to do is to tell some of his old customers who have done business with him for many years that the time has come when it's necessary for them to make a change in their agency. More times, however, we allow these things to drift along until we accept final settlements on the liquidation of the business that average about 25 cents on the dollar. A good cost system saves many a man his original principal and shows him when he must strengthen his organization or sell it to some one else who is younger and wishes to put more energy and is willing to risk more capital in the business than most of us are inclined to do as we pass down towards the shady side of life.

Today we very often read articles and hear men talk about the evolution of a business, when really we are going through an age of revolution, as we seem to advance to a stage when the present generation do not want to wait for time to bring about changes, but must attend to it at once, and that means revolution. We are having a revolution in morals, both in society, government and individuals. Readjustment is the order of the day, and unless a man is up and doing he is very liable to find himself or his business swept off its feet.

This question of the rapid changes going on in the business world is a very serious one, and I fear too few people realize it. It is a subject in itself and one which I have thought seriously talking to you about today rather than the one I have selected.

But coming back to the question of the application of our costs to our business. I want to make it very personal, if possible, and I want to ask each one of you this question: How well are we doing this? Will you answer me seriously? Who is setting your selling prices today; are you doing it on the basis of your costs or are you allowing your competitor to do it or some shrewd farmer who is a little better buyer than you are a seller? I am afraid there is a good deal of this going on today, and you know the old saying is, "No one is so badly fooled as the one who fools himself."

I read this little line the other day in a folder that came to my desk:

"A front, a bluff an' a little paint
An' the world'll think yer what ye ain't."

I think it fits in here very nicely, and we can all learn a lesson from it.

A few days ago I noticed an advertisement of a local dealer that had been sent in as a sample ad to one of our trade papers, and I was particularly interested in the price set on the different articles listed in the advertisement. One thing I particularly noticed, and that is all I will mention, was the price of gang plows, \$55, and on account of a reduction in freight rate of 20 cents per cwt., the dealer then felt that he should give his customers the advantage of it, and reduced the price to \$54.

Do you think that there could have been any cost system applied when these selling prices were made?

I also have a circular letter on my desk that came in a few days ago, about a dealer trying to reduce his stock of goods, of which he admits he was carrying entirely too much. He states in his circular letter, which he sent out to 650 of his customers, that he is offering these goods at wholesale, and below he gives the wholesale prices on an entire line of implements and vehicles, which are actual wholesale prices.

How many of you men present want to hand a circular letter to your customers setting forth the wholesale prices on an entire line of goods, so that they can file it away for reference, to be used at any time in the future they wish to buy goods of you?

This dealer admits in a letter of inquiry sent him that after two weeks' effort trying to sell goods at wholesale that he did not sell enough to pay for the expenses.

How much damage do you suppose he has done to his business and to the business of every other dealer in that vicinity?

It is absolutely inestimable. Do you think that this dealer knew anything about cost accounting, to say nothing about knowledge of the ordinary business principles?

The only competitor you have that I know anything about in the retail implement business is the man engaged in it like yourself, and the whole question simply means that you must work more together, have more confidence in one another and remember that nine-tenths of your troubles are caused by one or more of your own number and the remedy lies within yourselves.

I do not want to in any way excuse the manufacturer from the responsibility he holds in this matter. Those of us who are depending upon you dealers, to whom we sell the output of our factories, must do everything we possibly can to assist you in making business conditions better in your line and to come right down to home, for that's what you are interested in; the manufacturers who are doing business here in central Illinois must put their shoulders to the wheel and help build up this Illinois association second to none in the country.

I want you to know we appreciate very much the opportunity you have given the National Implement and Vehicle Association to be represented on your program.

AUSTRALIAN FIRM ADOPTS PROFIT-SHARING PLAN

At a meeting of the employes of Duncan & Fraser, Ltd., of Adelaide, Australia, held last month, Richard Duncan, on behalf of the directors, made a pleasing announcement. In the course of his remarks he referred to the growth of the company's business, and in particular to the success which had attended it during the twelve months just ended. He assured his hearers that the directors had always had the interests of their employes at heart, and mentioned that they were the first carriage building firm in Adelaide to adopt an eight hour day, Saturday early closing, and payment on Fridays. As a further proof of their interest in the employes he had pleasure in announcing that the directors had decided to share some of the year's profits with them, and accordingly he was glad to make known the particulars of the profit-sharing plan. Mr. Duncan then announced the principle upon which the bonuses would be allocated. In concluding, he said that the present was perhaps a somewhat daring time to distribute profits, but he had confidence in the stability of the company to weather future bad times if any should unhappily arise through the disturbed state of trade. They had just secured another large contract, and they hoped to be able to maintain full time in the workshops. At the conclusion of Mr. Duncan's remarks three hearty cheers were given for the directors by the employes.—Australian Wagon Builder and Wheelwright.

LULL CARRIAGE COMPANY TO INCREASE FORCE

President H. A. Crawford, of the Lull Carriage Co., announced yesterday that the carriage factory would add 75 employes to its payroll this week and that before January 1 the institution would be working to its capacity.

"Orders for our spring trade have come upon us in an avalanche," he said, "and we shall have to add additional men to meet the demand."

President Crawford declared that the improvement of business conditions the country over is indicated by the increased orders that have come into the Lull Carriage Co. during the last few weeks and stated that the prospects were never brighter.

The addition of 75 men to the working force of this concern will furnish employment to workmen who live and maintain families in Kalamazoo and they will enter upon the job with an assurance of steady employment throughout the winter months. The additional force will be added Tuesday or Wednesday, it was stated.—Kalamazoo Gazette, December 6.

PURE BRED DRAFT HORSES INCREASING

According to the report recently issued by Mr. Wayne Dinsmore, secretary of the Percheron Society of America, the breeding of draft horses shows improvement, with pure-bred sires on the increase and grades decreasing. The Percheron leads by an enormous preponderance, among the pure-bred draft stallions in the leading draft horse breeding states, i. e., in the order of their importance: Iowa, Illinois, Nebraska, Minnesota, South Dakota, Wisconsin, North Dakota, Pennsylvania, California and Oregon. Belgians are second to the Percherons in number, with Shires third, French draft fourth, Clydesdales fifth and Suffolk sixth.

Illinois shows a 2 per cent. decrease in grade sires; Minnesota, 7 per cent. decrease; North Dakota, 9 per cent. decrease; Wisconsin and Pennsylvania each show 11 per cent. decrease. Iowa has the lowest percentage of grade stallions of any state, as only 30 per cent. of the licensed stallions in that state are grades.

There has been a marked increase in the number of pure-bred sires.

Despite the gain noted, there is still an unnecessarily large number of grade stallions in service.

The number of pure-bred draft sires is not sufficient to bring about as rapid improvement as is desirable. Only one state—Iowa—has gone below the 300 mark. Experienced horsemen know that in the best draft horse breeding districts there should be at least one pure-bred draft sire for each 200 horses. Inasmuch as there is but one such sire for each 356 horses in the ten states named, and as at least one-fifth of these sires are not of such type and soundness as to warrant their retention in the stud, it is evident that we have not to exceed one good draft sire for each 445 horses, or considerably less than half as many good pure-bred draft stallions as we should have. As a matter of fact, we now have—on the average in ten states—about one good pure-bred draft stallion where there should be three.

Iowa has taken front rank. She has more pure-bred sires in proportion to total number of horses, and more to her total number of farms, than any other state.

The Percheron is by far the most popular breed in America. In every state it outnumbers all other draft breeds combined. Sixty-four per cent. of all the pure-bred draft stallions in use in these ten leading states are Percherons. In the two greatest of all draft horse states—Iowa and Illinois—the Percherons have made substantial increase, making an increase of over 5 per cent. in Iowa and an appreciable gain in Illinois.

"The overwhelming popularity of the Percheron horse in America," says Mr. Wayne Dinsmore, secretary Percheron Society of America, Union Stock Yards, Chicago, Ill., "is the most conclusive evidence that could possibly be presented to show the advantages possessed by the breed."

NEW SPECIFICATIONS FOR HICKORY HANDLES

Through new specifications for ax, sledge, adz, pick and other hickory handles, the Panama canal authorities have recently purchased large quantities of this class of material for one-fourth less than formerly paid, and at the same time are getting just as serviceable stock.

The war department and the navy department, as well as the Panama canal commission, have adopted these specifications, which were prepared by the forest service primarily for the use of the various branches of the federal government. Subsequently, however, they have been approved by the trade, both manufacturers and dealers, and adopted by several of the leading railroads.

The new rules are the result of a long study of the subject, covering exhaustive strength tests, investigations of the growth of hickory in the woods, processes of manufacture, and market conditions. Under the new specifications handles are selected

according to weight, as influenced by the density of the wood, and they now include material which may be either partly or wholly of heartwood, known generally as red hickory. Red hickory was formerly discriminated against in commercial grading, but it is now accepted, since it has been found that weight for weight it is just as serviceable as the white hickory. Handles which contain small sound knots or bird pecks, so located as not to affect the strength, are also accepted.

CANNOT MAINTAIN PRICES

Judge Hollister, of the United States District Court in Cincinnati, O., recently dismissed a bill of complaint brought by the Ford Motor Co. against the Union Motor Sales Co., Dayton, O., the basis of which was price cutting.

The Union Motor Sales Co. is in a way a co-operative organization; customers are supposed to be stockholders, taking a \$10 share of stock before sharing in the benefits of the company; goods were advertised at less than regular prices, and one of the favored items had been Ford cars.

Ford had declined to sell this company cars and in the suit which was brought about a year and a half ago charged that the Union Motor Sales Co. had conspired to obtain cars from regular Ford dealers, which cars were sold at less than list; this suit asked \$50,000 damages and an injunction restraining the Motor Sales Co. from selling any more Fords. A preliminary injunction was granted July 1, 1912.

A year later Ford charged Lucien A. Howard and O. D. Noble, of the Motor Sales Co., with contempt of court in continuing the forbidden practices; the charge was sustained in court. But within the past year or so there have been numerous high court opinions on price maintenance and these undoubtedly had much to do with Judge Hollister's ruling. He dismissed the Ford suit in its entirety.

NEW MOTOR FUEL IS NOT MEETING INVENTOR'S EXPECTATIONS

An announcement contained in a circular letter from President Carl G. Fisher, of the Prest-O-Lite Co., Indianapolis, Ind., is to the effect that recent developments have failed to bear out the expectations of those who were interested in the introduction of the new fuel, Zoline. Mr. Fisher explains frankly that the experiments have not been satisfactory up to the present time as regards cost, or in the general manufacture of the fuel.

"We are interested, of course," says President Fisher, "in assisting any inventor who may have a new fuel which will benefit motorists, but the closer we get down to facts in this particular fuel the more we are inclined to believe that it is even more expensive than gasoline. The entire plan does not seem to be practical.

"As is well known none of the people connected with this company would for a minute have anything to do with an article that was not exactly as represented, and we are not responsible for the large amount of publicity which has been given the new fuel.

"There are some points about the new fuel that even at this time we cannot explain, but we are continuing our experiments and hope in a few days to have all points made perfectly clear. In the meantime we do not wish to have the importance of the experiments over-estimated."

GOODYEAR'S WORKMEN'S HOMES

Nearly 200 workmen's home have been completed by the Goodyear Tire & Rubber Co., Akron, O., and occupied by employes' families, and many more applications for homes will be acted upon next spring.

President F. A. Seiberling, the originator of the idea, bought several farms at the edge of the town, not far from the works. A design for the community was arranged by an eastern land-

scape gardener, streets were laid out and pavements, sidewalks, sewer, gas and water pipes, etc., were put down. The total cost of the land and improvements was divided into actual lot prices, without profit. Then contracts for houses were let in large numbers, insuring lowest costs, and the completed properties turned over to workmen and paid for as rent. No initial deposits were required.

One of the strongest features of the plan is that every house has individuality, brick, brick and stucco, and frame being included in the numerous designs.

JACKSON AUTO CO. GETS BIG WAR ORDER

Announcement was made in Jackson, Mich., November 28, of a big order of trucks secured by the Jackson Automobile Co. for the French government. It is claimed that the order will amount to over a million dollars and that it will take nearly 1,000 men to execute the contract. It is thought that it will take at least 90 days to turn out all the trucks, but most of them will be ready for delivery by the end of 60 days. The contract will mean extra work and enlarged forces for several local auto accessories factories such as the Hayes Wheel, Sparks-Withington, Lewis Axle and Alloy Steel Spring companies. Officers of the Jackson Auto Co. have not made public the price of the truck, but it is understood to be around \$700, making the number of trucks about 1,429. They will be used in the European war.

WILLYS-OVERLAND BUSINESS FLOURISHING

According to a published statement, the books of the Willys-Overland Co., on November 25 showed a larger volume of sales since the start of that company's fiscal year on July 1, than that for the entire six months ending January 1, 1914. In other words, Overland business today already is considerably a month in advance of that of the last fiscal year when the total output of the company aggregated 45,000 cars. For the present calendar year this number has already been exceeded by several hundred cars.

Foreign orders for Overland cars received up to November 25 exceeded by 12 per cent. those received by the corresponding date of last year, with the unfilled orders for foreign shipment amounting to two and one-half times those on hand on the same day a year ago.

PRATT INSTITUTE WILL PRODUCE ANILINE COLORS

Pratt Institute, Brooklyn borough of the metropolis, is taking a lead among American colleges and preparatory schools to point out to the textile and leather trades the only certain way out of the present difficult dyestuff situation. In other words, the institute will make aniline colors. Dr. Edmonds, of the faculty, announces that the Pratt school of learning is making ready to produce several hundred pounds of various basic color dyestuffs and this work will be under the direction of Dr. Allen Rogers, and the dyestuffs will be strictly from products of American resources, namely, American coal, American produced coal tar and domestic made distillates will be worked in American vessels by American machinery, eliminating all foreign agencies whatsoever.

QUICK DEMOUNTABLE LIMOUSINE TOP

The Motor Car Mfg. Co., Indianapolis, Ind., announces that it has produced a quick demountable limousine top for use in connection with its Model 7-B Daniel Boone seven-passenger touring car. The company claims that in this new model it has produced a top so nicely balanced in design, finish and fit, that the car equipped with it can hardly be distinguished from a regular limousine. The list price for this top, f. o. b. Indian-

apolis, is \$675, and the list price of the complete Model 7-B together with the quick demountable limousine top, is \$2,997.

The top itself is upholstered in Bedford limousine cloth and is claimed to be the equal in detail of appointment to any limousine or sedan body, even to the pullman reading lamps in the corners.

FOREIGN DRIVERS FEW AT "500 MILES"

Entry blanks for the next Indianapolis 500 mile race are now in preparation. There will be a number of changes from the requirements of last year, although details, save for the fact that the piston displacement limit will be 300 cubic inches and that the date will be May 29, Decoration Day next year falling on Sunday, are not available.

Several American factories, including Stutz, Maxwell and Mercer, are known already to have models of proper size under construction, so that no difficulty in filling the entry list is anticipated. Foreign entrants, of course, it is generally thought, will be few.

STUDEBAKER PROFITS DOUBLED

The net profits of the Studebaker Corporation for 1914 will be more than double that of 1913, according to information. On the basis of actual figures for the nine months ending September 30, it is estimated the profits, after depreciation and interest charges, will be about \$4,000,000, comparing with \$1,904,823 last year. Accordingly the surplus available for dividends on the common stock would be equal to 11 per cent. on the \$27,931,600 stock outstanding. Since January 1 the company's serial notes outstanding have been reduced from \$6,800,000 to \$5,800,000. In addition to the \$800,000 that matured, the company cancelled \$200,000 bought in the open market.

OCTOBER TRUCK EXPORTS \$3,055,351

The large demand for commercial cars as a result of the European war is shown in the October exports, made public December 8 by the Federal Bureau of Statistics. In that month 672 commercial cars, valued at \$2,286,964, and 732 pleasure cars, valued at \$768,387, were exported, as against 79 commercial cars, valued at \$129,506, and 1,697 pleasure cars, valued at \$1,663,716, exported in the same month last year. The exports for the ten months ended October last were, 1,309 commercial cars, valued at \$3,353,509, and 20,262 pleasure cars, valued at \$17,888,351.

CRUDE RUBBER PRICES SOAR

A steady rise in the price of crude rubber during the last ten days or two weeks have given tire men something to think about. In the last week of November crude rubber could be bought at 63 and 64 cents per pound, for the up-river fine Para grade, and the same grade now costs 72 to 74 cents per pound. Plantation rubber, especially the best grade of smoked sheets, has reached 82 cents a pound, which is an increase of 25 per cent. in two weeks. The quantities imported in November were smaller than in any preceding month.

PREMIER RECEIVER FILES SCHEDULES

A report of the assets and liabilities of the Premier Motor Mfg. Co., Indianapolis, Ind., has been filed with Albert Rabb, referee in bankruptcy for the United States Court, by Frank E. Smith, receiver for the company. The assets are stated to be \$307,376.50 and the liabilities \$508,468.52.

The plant is being operated by the receiver and the present plan is to continue operating it so long as the court gives its consent. Thus far the operation of the plant by the receiver is said to have been satisfactory from a business standpoint.

PROGRESS OF THE UNITED STATES, 1800-1914

An epitomized record of the nation's growth in area, population and resources is contained in a pamphlet just issued by the Department of Commerce through its Bureau of Foreign and Domestic Commerce, entitled "Statistical Record of the Progress of the United States, 1800-1914." In all cases where the statistical data permit, the tables cover more than a century; the later inauguration of certain lines of statistics necessarily restricts, in those cases, the period covered.

A half-century retrospect, readily available by reference to tables appearing in the pamphlet, affords a clear perspective of the nation's growth. Since 1850 the population of the United States has more than quadrupled, being approximately 100 million at the present time. In the same period, however, foreign commerce has grown from \$318,000,000 to \$4,259,000,000 and the per capita value of exports from \$16.96 to \$23.27. National wealth has increased from \$7,000,000,000 in 1870 to approximately \$140,000,000,000; money in circulation, from \$279,000,000 to \$3,419,000,000; and New York bank clearings from approximately \$5,000,000,000 to over \$98,000,000,000, while for the entire country bank clearings have grown from \$52,000,000,000 in 1887, the earliest year for which figures are available, to \$174,000,000,000 in 1913.

In 1850 depositors in savings banks were 251,000 in number; today the number is 11,000,000 with deposits, exclusive of those in other savings institutions, aggregating \$4,750,000,000, or more than 100 times as much as at the middle of the last century.

In creased activity on the farm, in the factories, and in the great transportation industries has also developed during the last half century. The value of farms and farm property increased from \$4,000,000,000 in 1850 to \$41,000,000,000 in 1910; the value of manufactures, from \$1,000,000,000 to over \$20,000,000,000; and the number of miles of railway in operation from 9,021 in 1850 to 258,033 in 1912. In the last quarter century the number of passengers carried has increased from 492,000,000 to 1,004,000,000, and the volume of freight handled from 632,000,000,000 to 1,845,000,000 short tons. Nearly 20 billion pieces of outgoing mail matter are handled annually by the post office department, which disbursed in this important public service last year \$262,000,000, or \$2.70 per capita.

LYONS ATLAS CO. WILL BUILD NEW AUTO

Fortified with one of the largest and most complete manufacturing plants of its kind in the country, the Lyons Atlas Co., of Indianapolis, Ind., engine and automobile builders, has increased its capital stock preparatory to entering the automobile field on an extremely large scale. The company, which now builds the Lyons-Knight car, is preparing to place a medium priced car on the market, which it is said will be one of the sensations of the year.

J. W. Lyons, president of the company, refused to discuss the type of car that his company would build beyond the general statement that it would set a new standard in moderate priced motor car value, featured by style and easy riding.

COURT REFUSES TO DROP CHARGES

The prosecuting attorney of Kalamazoo, Mich., recently asked the court to drop all pending charges against Victor L. Palmer, formerly secretary of the Michigan Buggy Co., who is serving a sentence of two years in the federal prison at Fort Leavenworth for fraudulent use of the mails. A special prosecutor, who had assisted in the trial of Palmer, objected, and the court refused to drop the charges.

A. H. Glammeier recently purchased the wagon shop of John Ring, at Shenandoah, It., and has associated with him his father, E. Glammeier.

ST. LOUIS TO HOLD HARDWARE AND VEHICLE SHOW

An exhibit of hardware and vehicles will be held in St. Louis, Mo., in the Coliseum, January 19 to 22, inclusive, according to announcement of the officers and executive committee of the Missouri Retail Hardware Association, which met at the Marquette Hotel. The Mississippi Valley Implement and Vehicle Dealers' Association will exhibit jointly with the hardware merchants.

DEERES SELL WAGON PROPERTY

The property of the Davenport Wagon Co., of Davenport, Ia., has been sold by Deere & Co. to French & Hecht, of Davenport. The latter company formerly owned both the property and the business, but several years ago sold out to Deere & Co. The Deere interests have decided to concentrate their wagon manufacturing business in Moline and will move the Davenport business to that city. Only the real estate has been purchased by French & Hecht. That company will use the property in the extension of their mammoth metal wheel business.

WILL MANAGE ANDERSON COMPANY

Wm. F. Orcutt, of Indianapolis, Ind., for 25 years with the McFarlan Carriage Co., of Connersville, Ind., has been made manager of the Anderson Buggy Co., at Anderson, Ind. Frank Ringo, who has been connected with the manufacturing end of the company for several years, has been made superintendent. E. L. Anderson, who has been manager of the company for 25 years, retires to the position of councilor to the company. Officers declare that the outlook is good for the carriage business during the coming year.

BECOMES ILLINOIS REPRESENTATIVE

The Mitchell Wagon Co., of Racine, Wis., has announced the appointment of Chas. H. Hyde as representative in Illinois. Mr. Hyde will look after the sales of the Mitchell company in the entire state and make his headquarters at Decatur. He succeeds W. W. Dolbear, who recently resigned to accept a position with another company. Mr. Hyde has had a long experience in the wagon trade and has been connected with the Mitchell Wagon Co. for a number of years as representative in Iowa and Texas.

CHANGES POSITION

M. A. Coates, the well known Illinois traveling man, has resigned his position with the Stoughton Wagon Co., of Stoughton, Wis., with which he has been connected for several years, to become agent in Illinois and Indiana for the Northwestern Mfg. Co., of Ft. Atkinson, Wis. Mr. Coates has been traveling for various implement and wagon concerns in Illinois for over 20 years.

WILL HOLD IMPORTERS' SHOW

Despite the war conditions abroad, the Automobile Importers' Alliance will hold its annual salon next January at the Hotel Astor, New York City, as usual. The Paris and London shows have been abandoned this year, so the New York show will be about the only exhibition in the world to show foreign cars.

TO BUILD AUTOMOBILES

The Youngstown Carriage Co., Youngstown, O., expects to have the new addition to their building completed by the first of the year. The new plant will be devoted exclusively to automobiles.

HORSES FOR AMERICAN SOLDIERS

Plan of United States Department of Agriculture for the Breeding of Army Remounts, etc.

The United States Department of Agriculture has completed for the present the purchase of stallions for use in the encouragement of the breeding of horses for military purposes. Four Morgans, ten standard breeds, eleven American saddle horses and nine thoroughbreds have been purchased. These stallions, with four or five Morgans from the Morgan horse farm and six thoroughbreds presented to the government, are available for public service during the season of 1914, making a total of at least 44 stallions. Local wishes are respected and the breed of the stallion placed in a community is that which is most generally preferred by that community. Accordingly the Morgan stand in Vermont and New Hampshire, the thoroughbreds mainly in Virginia, the saddle bred horses and standard breeds mainly in West Virginia, Kentucky and Tennessee. Furthermore, every effort is made to avoid competing with privately owned stallions, and horses are not placed in communities which are already well supplied.

The government has not spared expense in the purchase of horses. The first requisites were that they should be good, sound individually and registered in proper stud books. Good breeding was, therefore, essential, and in many cases stake and show ring winners were obtained, but no horse was bought solely because he was a race winner or solely on account of his pedigree.

These horses are available for public service on liberal terms. The owners of sound mares, with a square trotting gait, may breed such mares free of charge provided they give the government an option on the foal during the year it is three years of age at \$150. However, the government will not hold the breeder of a foal to his option if he wishes to be released, but will allow him to cancel the option at any time by paying the service fee. This fee will be \$25 for mature stallions, and less for those under five years of age. In buying the colts the War Department has agreed to purchase both mares and geldings. No service fee will be charged unless the owner elects to cancel his option. If the government buys the colt no fee is charged; if the colt is offered to the government and purchase refused, no fee is charged.

On account of the provision for free service, the government believes that the mares bred should be suitable for the purpose, and therefore it will be necessary to breed only those which are free from the following unsoundnesses: Bone spavin, ring bone, side bones, heaves, stringhalt, lameness of any kind, roaring, periodic ophthalmia and blindness, partial or complete. Mares must also be free from manifest faults of conformation, such as curby hocks. Pacing mares will not be bred. Approved mares will be given a certificate of registration in the Remount Brood Mare Register of the Agricultural Department.

I believe it advisable for our jack and mule breeders to avail themselves of this opportunity. Our farms and commerce need more and better horses. In fact, there has never been a time within my knowledge when good useful horses were in such demand and so scarce. I would suggest that every thoroughbred breeder and owner would discontinue the practice of gelding good looking, sound colts. The time has arrived, in my opinion, when they will be sought both by the government and the farmers. With the increased use of motor-driven vehicles, trucks, etc., it is becoming to be popularly believed that the horse will soon be an obsolete animal. Such is far from being the case. The following table of statistics is taken from the records of the National Association of Allied Horse Interests, Providence, R. I. The eleven cities mentioned have a combined population of over 2,880,000 inhabitants:

Number of Horse-Driven Vehicles Licensed for Business Purposes in Eleven Cities During 1910, 1911, 1912, Showing Per Cent. of Increase

	1910.	1911.	1912.	Increase % 1910-12.
Baltimore, Md.....	15,421	15,538	15,680	1.67
Boston, Mass.....	15,833	16,656	17,100	8.00
Buffalo, N. Y.....	11,778	11,718	11,900	1.04
Galveston, Tex.....	1,713	1,742	2,186	27.61
Mobile, Ala.....	1,217	1,311	1,320	8.46
Pittsburgh, Pa.....	10,264	10,003	11,148	8.61
Providence, R. I.....	5,321	7,864	9,044	69.96
Richmond, Va.....	3,360	3,452	3,514	4.58
Vicksburg, Miss.....	140	160	150	7.14
Worcester, Mass.....	317	681	1,738	148.58
Salt Lake City, Utah...	502	510	1,055	110.16

If the use of the horse is increasing in large cities where the streets and adjacent roads are better, you may know they are more rapidly increasing in all of the cities of 100,000 inhabitants and under which dot this broad country.

So I wish deliberately to repeat that it seems to me it would be an economic crime for the American nation to be deprived of the benefit of the thoroughbred blood.

In speaking or thinking of the thoroughbred horse, the mind naturally associates it with the thrilling and heroic exhibitions of courage and of fleetness on the turf. I have no apologies to offer in this connection, for the turf is an ancient and honorable institution. Like everything else in life, it has just as much dignity and character and honesty as we put into it. Every man, be he racing official, breeder, owner, trainer, jockey or stable boy, should feel an individual sense of responsibility for the honor and welfare of the turf, and jealously protect it. It cannot be any better or worse than the racing associations, on the one hand, and the owners, trainers and jockeys, on the other hand, make it. It is far from a one-sided proposition and a positive loyalty in all things is due from each to the other.

So in speaking of the future of the thoroughbred, and the same may be said of the standard bred trotter, it rests entirely in the conception and execution of the duty the associations owe to the public who support it, and the fealty and hearty co-operation your enlightened self-interest should compel you to render to it.

OUR BUGGY BUSINESS

I think that we as buggy men should protest against this idea that is being advanced by the automobile advertisers that the horse and buggy are on the toboggan.

In the first place it is not true. There are far more buggies made every year than automobiles.

In the second place it is an attack upon our business that we should not meekly accept.

In the third place it is encouraging an extravagance which is bad for the country at large and it especially hurts the fellow who takes the bait.

The buggy business is a live proposition and he who thinks it is a dead one does not read the signs of the times. The buggy dealer who slows up on his efforts is going to miss opportunities.

All indications point to a constantly increasing demand for horse-drawn vehicles for many years to come.

All buggy dealers should talk buggies; holler buggies. It is a live issue.—S. M. Piper.

ORGANIZE VEHICLE CLUB AT COLUMBUS, O.

The Columbus Implement and Vehicle Club has been organized at Columbus, officered as follows: President, E. S. Baldwin, Osborne Division, International Harvester Co.; vice-president, E. B. Wilson, John Deere Plow Co.; secretary, R. F. Alspach, Birdsell Mfg. Co.; treasurer, E. R. Meyer, Johnson Harvester Co. The membership embraces a majority of the implement and vehicle houses of Columbus.

ECONOMIC RESOURCES OF THE UNITED STATES

A partial inventory of the national assets of the United States in area, population, and the fundamental factors of economic life reveals the fact that it is not only practically self-supporting but that it possesses, in many lines, a large surplus available for protection against famine and temporary adversity or for use in meeting unusual demands from the outside world. Recently the Bureau of Foreign and Domestic Commerce has been receiving hundreds of letters from American producers and manufacturers making inquiries regarding possible markets abroad for their surplus products and as to the ability of the United States to supply the raw materials necessary to their industries. Investigations in connection with the replies to these inquiries have developed the fact that in many instances materials now imported from abroad are of a class found in this country, the production of which, however, is still in the initial stages. This is particularly true of numerous basic materials used in the chemical industries, which were formerly wasted, but are now partly utilized.

The peculiarly fortunate position of the United States in its ability to supply its own needs is clearly seen from a survey of its production and relative contributions to the world of the great requirements of man—food, clothing, and shelter. It is found, for example, that the people of the United States may be readily fed by home-produced foodstuffs, our vast area of 3 2/3 million square miles representing every variety of climate and production and nearly equal in extent to all Europe with a population five times that of this country. Agriculture in the United States has not yet reached the stage of scientific development common to many countries of Europe, and the present domestic production may therefore be expected to increase greatly with more attention to improved methods of culture. Nevertheless our country already produces over 2 1/2 billion bushels of corn, or two-thirds of the world's supply. This year's wheat crop is estimated at the high-record figure of 911 million bushels, about 20 per cent. of the world's harvest. The United States also produces annually over 1 billion bushels of oats, or one-fourth of the international yield, and 197 million gallons of cottonseed oil, representing most of the annual output of this article, whose food value as a substitute for olive oil is becoming more and more recognized. Fifteen per cent. of the world's cattle are on American farms, the number in this country being 59 million, or twice as many as in Argentina or European Russia and half in number those of India. Our country also has 60 million swine, or three times as many as Germany; 50 million sheep and 24 million horses. We import, however, 5 billion pounds of sugar (chiefly Cuban), or one and one-half times the amount produced in continental United States and its island territories.

In the mineral kingdom the preeminent position of the United States is unquestioned. We produce, for example, 534 million short tons of coal, 40 per cent. of the world's output, and nearly twice as much as the United Kingdom or Germany; 238 million barrels of petroleum two-thirds of the world's total, and three times as much as Russia; and 57 million tons of iron ore, out of a world's total of 132 million, the production in this country being twice that of Germany. One-half of the world's copper is taken from American mines, which turned out 1 1/4 million tons in 1912. Of the world's output of 466 million dollars' worth of gold, the United States produced about 20 per cent., being exceeded only by South Africa. About 28 per cent. of the world's silver and 30 per cent. of its lead are produced in this country.

In the value of manufactures the United States leads the world, though the product of American factories is chiefly consumed at home. Of the 20.7 billion dollars' worth of manufactures produced in the United States in 1909 only about 5 per cent. were sold to foreign countries, the world's market for iron and steel products, cotton goods, chemicals, and other

important products of industry being thus far largely held by England, Germany, and other European nations.

The foregoing are indicative of the strong position of the United States in its supply of the factors of national wealth.

NEWARK, O., PLEDGES SUPPORT TO BLAIR TRUCK

The Board of Trade of Newark, O., at a recent meeting pledged both moral and financial support to the Blair Motor Truck Co., which was recently organized to manufacture motor buses. A committee of five was named to confer with the officials of the company with reference to its needs. It was stated that about \$60,000 additional capital was needed to take care of orders.

INDICATIONS GOOD AT HENNEY PLANT

According to a local paper the plant of the Henney Buggy Co., at Freeport, Ill., which was only working 30 per cent. of its force three months ago is now running 70 per cent., with the indications that the full force will be employed by the first of the year. This is the statement of M. A. Steele, general manager of the company. Mr. Steele is an optimist and is sure that better days are ahead for the vehicle trade.

AUTOS TO AID IN WAR TAX

It looks as though motor cars might have to help pay the war tax in the form of certificates to bear a small stamp and to cost owners and licensed chauffeurs 10 cents each. The total revenue from this source, if based upon the present figures, will reach approximately \$27,000, assuming that the tax is not repealed before next September.

J. M. STUEDBAKER INJURED

J. M. Studebaker, Sr., of the Studebaker Corp., South Bend, Ind., was painfully injured November 19 in an automobile accident. The car in which he was riding and another car crashed together in a blinding snowstorm. Mr. Studebaker is 81 years old, but his injuries were not regarded as serious.

AUSTRALIAN IMPORTS DECREASE

Australian imports of automobile and commercial car chassis decreased 8 per cent. for the calendar year 1913, compared with 1912, the figures being \$6,489,722 and \$7,063,700 for the respective periods. With the single exception of Tasmania, which gained 32 per cent., every state shows a decrease in imports of chassis. There was also a decrease of about 4 per cent. in body imports, the figure for 1913 being \$1,052,793.

C. H. Gleason, who has had seven years' experience with one of the most prominent eastern spring and axle companies, is now connected with the Kalamazoo Spring and Axle Co., Kalamazoo, Mich., in their sales and designing departments. Mr. Gleason is thoroughly familiar, not only with the spring and axle business, but also with the manufacture of carriages and automobiles.

Hugh F. Cartwright, formerly first vice-president of the Banner Buggy Co., St. Louis, Mo., who severed his connection with that company last August, is now president of the Commercial Auto Body Co., 3003 Locust street, St. Louis.

The Lansing Wagon Works, of Lansing, Mich., have discontinued making carriages, and are now confining their efforts to the manufacture of wagons. Business is reported to be very satisfactory.

ANOTHER BILLION IN ANIMAL VALUES

According to the statistics of the Department of Agriculture there are over 20,000,000 horses of all sorts and conditions in the United States. Power, whether it be that delivered by horses, mules or motors, is in strenuous demand from blazing Europe. The cavalry horse is wanted; the giant mule of Missouri and Kentucky is urgently desired, but in addition to this specific demand, there is a fierce bidding for any kind of an animal that can pull a wagon, gun carriage or ambulance. We are violating no confidence when we chronicle the fact that sweeping orders have been placed wherever there appear to be chances for having them filled, or that the total of accepted orders already reaches \$5,000,000. The requirements of the situation call for the purchase in America of \$100,000,000 of horse flesh within six months. When our own little uneasiness over Mexico became acute several months ago, the government bid \$142.50 a head for cavalry remounts. The last official quotation was \$175 to \$200 a head. The next level may be almost anywhere above those figures. It is not conceivable that it will be lower. So far as horses suitable for cavalry are concerned, the price level is now around \$200. Naturally, this advance is felt all the way through the various classes of horses and every class is higher in price than it was. Our statistical department has estimated from fragmentary figures that the general average advance in horse prices amounts to about \$40 a head. On that basis, the apparent wealth of the country has been increased \$800,000,000 in the single item of horses. Mules rose relatively to a higher level, and, taking the whole stock into consideration, it is not unlikely that another \$200,000,000 was added to the National Treasure. Thus the advance means a round billion of dollars more than we had before. The comparatively small fraction of the total number of horses and mules in this country that will be sold to Europe represents actual money, but the values created by the war demand in the remainder are quite as real. They may be found in the advanced price of food, because animal power is required in producing grain and if the surplus power is taken for war, the value of the rest must be higher. Thus, it appears that the enhancement of horse values is not what may be termed "paper profits," but, on the contrary, is a real and permanent addition to our wealth.

NONBURSTABLE INNER TUBE SHOWS GREAT STRENGTH

A nonburstable inner tube for use in motor car tires was demonstrated recently at New York where tests showed it possible to use worn-out casings without a blow-out resulting. Twelve taxicabs were employed and the new inner tubes placed in shoes which either were torn or purposely cut so that the tubes were exposed. The tires were inflated as if the cases were new, and the experiment showed the tubes to be of remarkable strength. The claim made is that with them every bit of wear there is left in an old shoe may be utilized.

MOTOR TRUCKS TO FEED FREIGHT TRAINS

A Canadian railway is planning a system of auxiliary transportation that will have the effect of extending the railway right into the baryard or field of the farmers living along the line. This service will consist of a fleet of motor trucks operated from each station by the railway company and specially designed for collecting farm products, including grain, and transporting them to the railway. The number of motor trucks at different stations will vary with the size and importance of the districts served, but it is expected that from 12 to 20 will be placed in service at the more important stations.

The Beardsley Electric Co., Los Angeles, Cal., will manufacture, in addition to its line of passenger cars, 1,000-pound and one-ton commercial chassis.

RIMS APLENTY

Twelve thousand tons (24,000,000 lbs.) of steel was converted into Firestone rims during the past year. It required 150,000 square feet of floor space and almost 400 mechanics to handle this tremendous volume of material. Sixteen electric welders are required, one of them especially constructed to handle stock 14 inches wide.

IMPORTANT TO CARRIAGE WOODSTOCK OWNERS

The Supreme Court of Pennsylvania has decided that the amount of damage collectible on growing timber set on fire through negligence is not only the value of the wood destroyed, but also the injury to the property as a whole through the destruction of the young growth.

AD. MEN WILL JUDGE TRADEMARK CONTEST

Carl M. Green, Theodore F. McManus and E. LeRoy Pelletier, of Detroit, Mich., have been selected to act as judges of the "Made in the U. S. A." trademark competition being conducted by the Detroit Board of Commerce. The board will give \$500 for the best design.

BAIN IMPROVEMENTS

The Bain Wagon Co., of Kenosha, Wis., has begun the erection of an addition to its plant. The improvements will consist of a two-story brick and concrete structure with basement, 54 x 192, and a new paint shop. They will cost about \$80,000.

TO MAKE TIRES IN BUCYRUS, O.

The abandoned plant of the Bucyrus Steam Shovel and Dredge Co., of Bucyrus, O., will be converted into a tire manufacturing plant. The work of remodeling the plant has been started and operations will probably be started by January 1.

NEW FORD PLANT IN CANADA

A new factory is being erected at a cost of \$300,000 for the Ford Motor Car Co., of Ford, Ontario, Canada. The building is to be six stories high, 200 x 195 feet in dimensions, of steel and reinforced concrete construction.

WILL PUT UP ADDITION

The Ottawa Leather Co., Grand Haven, Mich., will shortly begin the construction of a 200-foot addition to the japanning department. An increase in business necessitates the enlargement.

DENVER IS A CITY OF ELECTRICS

Denver already has 900 electrics, of which 63 are trucks. The city has 16 public garages capable of stabling 910 electrics, so some one will have to expand his floor area very soon.

SPOKE WORKS TO RESUME

The Buckeye Spoke Co., Centreville, Tenn., which has been idle for a number of weeks, is preparing to resume activity. It has large orders out for timber which will be put on the yards right away.

NEW BERGDOLL PLANT

The Bergdoll Automobile Co., Philadelphia, Pa., will erect a large manufacturing plant at Trenton Junction, N. J., near there.

Trade News From Near and Far

BUSINESS CHANGES

A. B. Ives has succeeded to the implement and vehicle business of F. P. Turner, at Sunfield, Mich.

J. L. Rudy, an implement and vehicle dealer at Covington, O., has been succeeded by B. C. Thomas.

Rezabek & Mikulecky have purchased the implement and vehicle business of M. Schwarz, at Wilson, Kas.

F. L. Johnson has succeeded to the implement and vehicle business at Parkman, O., formerly conducted by C. P. Alger.

Chas. W. Hanneman has purchased an interest in the implement and vehicle business of Byron Farrell, at Wentworth, S. D.

Albert Stembel, of Wheatfield, Ind., will conduct the implement and vehicle business of the late George C. Stembel, his father.

The Winkler Bros. Mfg. Co., of South Bend, Ind., has changed its name to Winkler-Grimm Co. The company is engaged in the manufacture of vehicles.

Floyd R. Gambell has bought out the vehicle and implement stock and business of Warren Burdine, at Keswick, Ia., and is continuing the store at the old stand.

Phalen & Cunningham, retailers in buggies and carriages at Newark, O., located in the Tucker block, have moved to Elmwood court and have taken over the business of James E. Jones.

James Plunkett, Sr., has retired from the implement and vehicle business at Kentland, Ind., by selling out his entire stock to H. A. Reinhart & Co., who will combine it with their own.

George W. Plank, Eyota, Minn., who has been engaged in the vehicle and implement trade in that city for the past 12 years, has sold out his business to F. R. Miland and Robert Lenton, of Stewartville, Minn.

The Troutman Implement & Seed Co., which will handle a line of buggies in addition to its other stock, has been incorporated at Owensboro, Ky., with a capital of \$15,000. The new corporation takes over the business of Troutman & Jesse, which was established some years ago. J. Edgar Troutman, C. S. Price and T. J. Lea were the incorporators.

NEW FIRMS AND INCORPORATIONS

Dallas & Bertrand will engage in the implement and vehicle business at New Iberia, La.

The Zimmerman Buggy Co. has been incorporated at Auburn, Ind., with a capital of \$10,000.

The Hermitage Spoke Co. has been incorporated at Nashville, Tenn., with a capital of \$30,000.

The Auto Wagon Brake Co. has been organized at Laurenceville, Ill., to manufacture a new automatic wagon brake. W. S. Titus is president.

The Windlass Wagon Brake Co. has been organized at Greensboro, N. C., with a capital stock of \$100,000 to manufacture wagon brakes.

The Racine (Wis.) Carriage Co. has been incorporated with a capital stock of \$25,000, by William H. Richardson, Joseph O. Kennedy and Jacob C. Lund.

Minton & Sons are on the ground at Barbourville, Ky., where they are equipping a factory to make wood parts of vehicles, etc., from hickory timber, which is abundant in the vicinity.

IMPROVEMENTS AND EXTENSIONS

In Hopkinsville, Ky., West & Lee are erecting a two-story brick addition to their carriage factory, their business having

grown to a point where additional accommodations were necessary.

C. L. V. Shupe, buggy and implement dealer at Lacona, Ia., is now located in a fine new store building. It is well located on the main business street of the town and has a 70-foot glass front which makes a good appearance and fills the store with light.

The Kelsey Wheel Co., of Memphis, Tenn., has announced an enlargement of its plant, which will necessitate improvements in the neighborhood of \$100,000. The Memphis plant is operated in connection with a plant in Detroit, Mich., of which Mr. Kelsey is also president, and J. E. Foley general manager.

FIRES

Heavy damage was done recently when fire destroyed the wood vehicle plants of F. B. Leonard & Co. and Leonard & Leonard, at Metropolis, Ind., just across the Ohio river from Paducah, Ky.

The plant of the Capital City Carriage Co., Des Moines, Ia., suffered a \$40,000 fire loss on December 5. The flames destroyed one building of the factory together with all contents. The chief loss was on finished vehicles and materials in the building. This amounted to about \$25,000 and the building loss was about \$15,000. Jesse H. Matthews, manager of the company, announces that plans will at once be made for the rebuilding of a portion of the factory. The business is being carried on in temporary quarters.

59,507 FORDS SOLD IN THREE MONTHS

During the first three months of the buyers' profit sharing plan of the Ford Motor Co., which started August 1, 1914, a total of 59,507 Ford cars were sold, or an average of 19,835 cars per month. The buyers' profit sharing plan called for a return or refund of \$40 to \$60, according to the car bought, provided that between August 1, 1914, and August 1, 1915, a total of 300,000 cars are sold and delivered. The 59,507 cars sold to October 31 represent a refund of at least \$2,380,280 on the basis of a rebate of only \$40 per car. By taking the average of \$50 as the return to each buyer, the amount to be returned by the Ford company would be \$2,975,350 for the first three months' business on the new plan. If the 300,000 cars are sold and delivered then the return to buyers will amount to between \$12,000,000 and \$15,000,000.

NEWARK LEATHER CONCERN INCORPORATES

Ryan Brothers, Newark, N. J., have incorporated under the name of the Ryan Leather Co. The new company now occupies the leather plant located at 28 Ferndon st., on an enlarged and improved scale. The capacity is much greater and the new plant has every facility for turning out the concern's usual high class product. Ryan Leather Co. will cater to the upholstery, saddlery and bag manufacturers and will specialize in Spanish, antique, and goat-grain leathers.

Thomas J. Ryan, of Ryan Bros., is president, and David Kohn is secretary-treasurer. The latter has been associated with M. Straus & Sons, Newark, for years.

It is reported that Wm. F. Orcutt, formerly with the MacFarlan Carriage Co., of Connersville, Ind., has been appointed sales manager of the Anderson Carriage Mfg. Co., of Anderson, Ind.

OBITUARY

John Bladon, the old-time carriage builder of Toledo, O., died October 6 at Detroit, Mich., where he had resided for some years. Mr. Bladon was of English birth, being born in the county of Durham, 82 years ago. His wife survives him, also a son and a sister.

Andrew Hansen, 80, for 50 years at the head of the Hansen Wagon Works, at Manitowoc, Wis., died in that city on December 4 from a stroke of paralysis. Mr. Hansen was born March 13, 1834, and moved to Manitowoc from Langeland, Denmark, in 1855, and five years later he established the plant which later became the Hansen Wagon Works and was for years one of the city's important industries. The company discontinued business four years ago and Mr. Hansen had since lived in retirement. His widow, three sons and one daughter survive.

Henry Scharch, 83, well known in the carriage building trade, died December 5 at his home in Watertown, N. Y. Mr. Scharch was born in Hesse Darmstadt, Germany, in 1831. He came to this country when 16 years old, and learned his trade in the Henry Brewster Co. in New York City, and become foreman of the blacksmith department when a very young man. In 1878 he went to South Bend, Ind., with the Studebaker Co., as foreman of the blacksmith department. In 1884 he moved to Watertown and had charge of this department in the H. H. Babcock Co. until two years ago, when he retired. Mr. Scharch was the inventor of the Brewster circle and other patents in the carriage trade.

James M. Wilhoit, one of the founders of the Springfield (Mo.) Wagon Co., died from dropsy. Mr. Wilhoit was 82 years old, and is survived by six sons and a daughter.

TO MAKE ELECTRIC VEHICLES

The Storms Electric Car Co., which has been organized at Detroit, Mich., to manufacture electric passenger and commercial cars, expects to place its product on the market in January.

One standard chassis will be made by the new company, to take three different bodies, a coupe, a roadster and a delivery body. Wheel base will be 90 inches and tread 44 inches, completely equipped with electric lights inside and outside, electric horn and other stock equipment. The coupe is to sell at \$950, the roadster at \$750 and the delivery car at \$650. The coupe will be made to seat three persons and the roadster two. The vehicles will be fitted with a specially designed battery which will travel 40 to 50 miles on a single charge. The commercial car will have a body to carry a load of 500 pounds.

William E. Storms, formerly with the Anderson Electric Car Co., is the designer and president of the company; Ferdinand H. Zilisch, a business man of Milwaukee, Wis., is vice-president, and F. T. King, Detroit, is secretary and treasurer.

Temporarily the headquarters are with F. T. King, 340 Gratiot avenue. Negotiations are now pending concerning a plant.

NEW HOLDING COMPANY

The General Spring & Wire Co., with a capital stock of \$10,000, has been organized to take over the business of the Michigan Spring & Wire Co., Detroit, Mich. Joseph H. Clark is president; August Peterson, vice-president and superintendent; C. L. Clark, secretary, and J. N. Reid, treasurer.

COLUMBUS TO HAVE NEW TRUCK FACTORY

It is reported that Weller & Thomas have had plans prepared for a motor truck factory, 100 x 190 feet, two stories, of brick construction, to be erected at Columbus, O.

INDEX TO ADVERTISERS

Baltimore Hub-Wheel and Mfg. Co.....	40
Backstay Machine and Leather Co.....	3d cover
Carter, The Geo. R. Co.....	40
Central Mfg. Co.....	40
Columbus Bolt Works.....	4th cover
Correspondence School of Carriage and Motor Carriage Drafting	2
Dowler, Chas. L.....	40
Eccles, Richard, Co.....	3
Fairfield Rubber Co.....	3
Gifford, John A., & Son.....	3
Keystone Paint & Filler Co.....	3
Lawson Co., F. H., The.....	2d cover
Masury, John W., & Son.....	2d cover
Miller Bros.	40
Mulholland Co., The.....	40
National Spring & Wire Co.....	2d cover
Payne Co., E. Scott.....	40
Pierce, F. O., Co.....	3d cover
Porter, H. K.....	3
Sheldon Axle and Spring Co.....	1
Sidney Mfg. Co., The.....	40
Standard Oil Cloth Co., Inc., The.....	4
Stewart-Mowry Co.....	4th cover
Technical School for Carriage Draftsmen and Mechanics..	3
Virginia and North Carolina Wheel Co.....	4th cover
West Tire Setter Co.....	2
White-Quehl Mfg. Co.....	40
Wilcox Mfg. Co., D.....	1
Willey Co., C. A.....	2

BUSINESS IMPROVEMENT AT HERCULES PLANT

F. K. Wilson, of the Hercules Buggy Co., Evansville, Ind., in an interview in a local paper, says orders now are coming in, and that after the first of the year he thinks the plant will be running under normal conditions.

WANTS

Help and situation wanted advertisements, 1 cent a word; all other advertisements in this department, 5 cents a word; initials and figures count as words. Minimum price, 30 cents for each advertisement.

PATENTS

Patents—H. W. T. Jenner, patent attorney and mechanical expert, 606 F St., Washington, D. C. Established 1883. I make a free examination and report if a patent can be had and exactly what it will cost. Send for circular.

SALESMEN WANTED

Wanted—Harness salesmen in all parts of United States. Liberal proposition. Experience unnecessary. Write immediately for territory. W. H. Rowerdink & Son, Rochester, N. Y.

SITUATIONS WANTED

Wanted—Position as sales manager or salesman; 18 years active experience; familiar with credits and every detail of vehicle business. Chas. H. Kelly, care Studebaker Bros. Co., 445 Broadway, New York City.

Position Wanted—By an experienced blacksmith foreman or assistant superintendent with first class carriage or wagon factory; expert in handling men and saving in production; age 36, married. Box 17, care The Hub, 24 Murray St., N. Y. City.

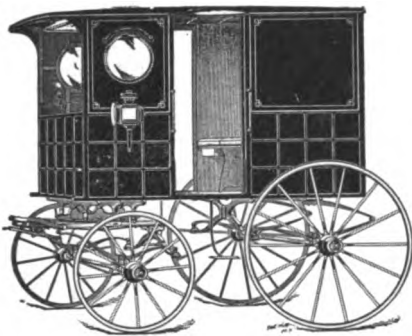

No. 112.—Milk Wagon.

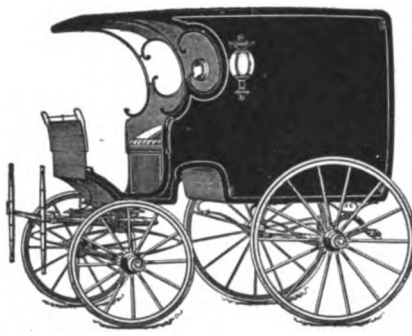

No. 111.—Altman Wagon.



No. 113.—Grocery Wagon.

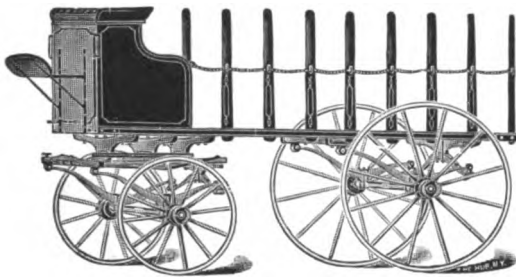

No. 122.—Flour Truck.

Electrotypes

of the vehicles presented on this page will be forwarded on receipt of

75 cts.

for each cut, to any address. Postage prepaid.

Catalogue

containing nearly 200 illustrations of carriages, wagons, sleighs, and miscellaneous cuts will be sent upon application.

Trade News Publishing Co.
24-26 MURRAY ST.
NEW YORK



No. 115.—Delivery Wagon.

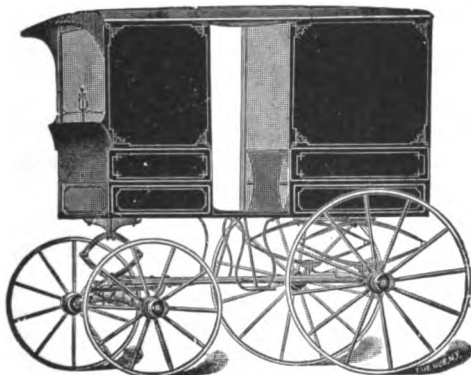

No. 116.—Milk Wagon.

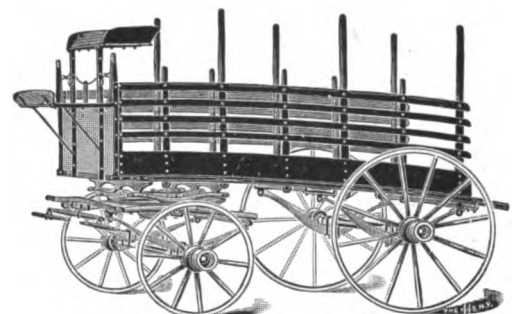

No. 117.—Merchandise Truck.



No. 114.—Delivery Wagon.

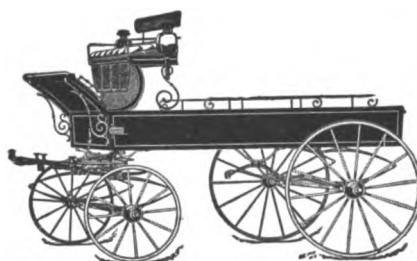

No. 124.—Delivery Wagon.

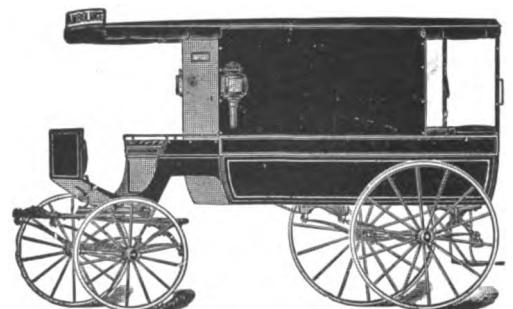

No. 118.—Ambulance.

BUSY BUYERS BRIEFS

Baltimore Hub-Wheel & Mfg. Company
Manufacturers of
Wheels AUTO MOTOR CAR CARRIAGE WAGON
Also **SPOKES and RIMS**
Factory: Harford Ave. and B. & O. R. R.
BALTIMORE MD.

CHARLES L. DOWLER
CARRIAGE AND WAGON HARDWARE
108 North Third St., Philadelphia, Pa.
CUSHION MANUFACTURER
Pure Stearic Acid Candles. Wheel Stock. Snow
Flake Axle Grease.

**Automobile and Carriage Leathers,
Leather Welts and Gimps**
All Kinds of Leather Specialties
WRITE US FOR PRICES
THE GEO. R. CARTER CO.
CONNERSVILLE, IND.

**MULHOLLAND
BUGGY SPRING**
Reduces weight of springs one-half.
Made in one size only but will fit bodies
of all widths.
Write for further particulars and prices.
THE MULHOLLAND CO. DUNKIRK, N. Y.

 **White's Brazing Sleeves**
For applying Rubber Tires
Send for Samples.
LINED
 **WHITE-QUEHL MFG. CO.**
431 E. Pearl St.
CINCINNATI, OHIO
UNLINED

STEEL SEATS AND BODIES
Not a Weld, Joint or Seam
CENTRAL MANUFACTURING CO.
CONNERSVILLE, IND.

**AUTOMOBILE
Bodies AND CARRIAGES
IN THE WHITE**
Estimates Furnished on Special Designs
MILLER BROTHERS
Amesbury, Mass.

E. SCOTT PAYNE CO.
Carriage and Automobile
HARDWARE
Horse - Shoers' Supplies
362-364 North Gay St., Baltimore, Md.

**Sidney Metal Buggy Seats
and Metal Bodies**
The Best in the World
Every Seat Guaranteed
THE SIDNEY MANUFACTURING CO., SIDNEY, O.

**Results always follow
advertising in
THE HUB**

**It Pays
Others**

**It Should
Pay You**

“TRIUNE” COLOR VARNISH

Is strictly a Varnish Product possessing color with the power to Cover in one Coat. It works as freely as straight varnish and will “flow,” “level,” “rub,” “moss” and exhibit in general full durable qualities and working properties.

THREE QUALITIES IN ONE PRODUCT

1—Color. 2—Power to cover in one coat. 3—Straight varnish working properties and qualities. Nothing like enamel or gloss paints. Different, distinct.

Sole Manufacturers

F. O. Pierce Company, New York City

12 West Broadway

**Subscribe
Now for**

THE HUB

**\$2.00
Per Year**

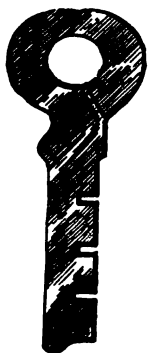

To Satisfaction on Welts and Gimps

A CUSTOMER ONCE—CUSTOMER ALWAYS

Backstay Machine and Leather Company

UNION CITY, INDIANA

BENT RIMS Hickory Second Growth and Forest Hickory
All Grades

OAK—STAR BRAND

SPOKES Second Growth Hickory—Finished and Club Head
SUITABLE FOR ALL VEHICLES, INCLUDING AUTOMOBILES

VIRGINIA AND NORTH CAROLINA WHEEL CO.

8 Bridge Street, New York City

RICHMOND, VIRGINIA

THIS TRADE MARK MEANS MUCH TO VARNISH USERS

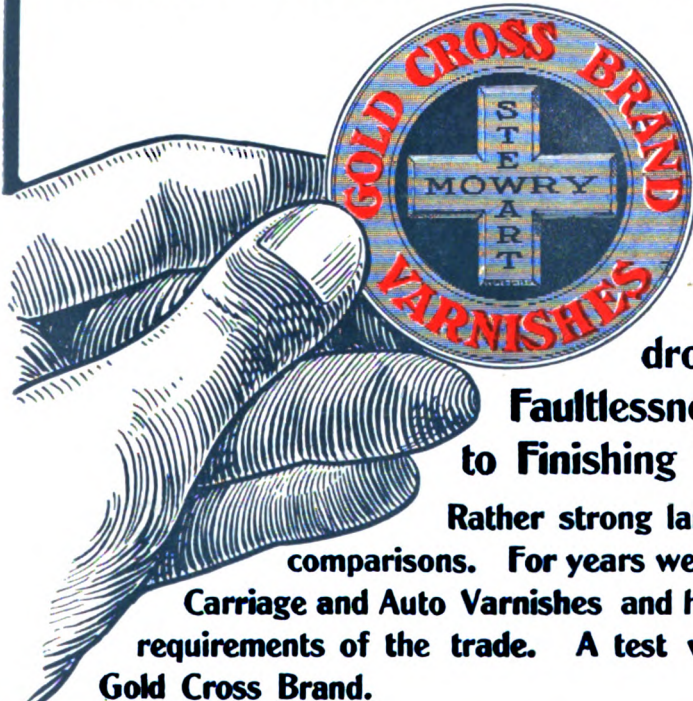

It signifies Quality. It is placed only on the best line of Varnishes we make---our Gold Cross Line. We stake our reputation on every drop that bears this brand. It implies Faultlessness, and has no superior from Japan to Finishing Varnish.

Rather strong language—but we can prove it; and we court comparisons. For years we have been making the most complete line of Carriage and Auto Varnishes and have put some very intensive study into the requirements of the trade. A test will convince you of the superiority of the Gold Cross Brand.

STEWART-MOWRY CO., CHICAGO, ILL.

Skewed Shaft Couplings

**Regular or Oval Patterns
For High Arched Axles**

Furnished in rights and lefts for any height of arch. Oval Axle Clips $\frac{5}{8}$ or $\frac{3}{4}$ width to match Oval Couplings. Bolts, Clips, Couplings, Carriage Hardware and Special Forgings

Catalogue "H" and Prices on Application

COLUMBUS BOLT WORKS, Columbus, O.

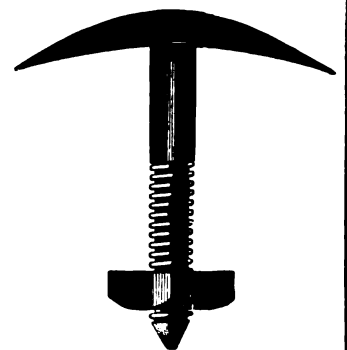
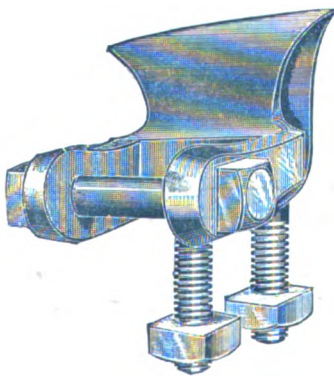

The Hub



TRADE NEWS PUBLISHING COMPANY
24-26 MURRAY ST. NEW YORK

JOHN W. MASURY & SON

Originators of

Superfine Coach and Automobile Colors

ACKNOWLEDGED THE STANDARD FOR FIFTY YEARS

And Manufacturers of

Fine Carriage and Automobile Varnishes

New York

Chicago

Minneapolis

Kansas City

"BLACK VELVET" CUSHION SPRINGS

Manufactured Only by the

NATIONAL SPRING AND WIRE COMPANY

ALBION, MICH. WINDSOR, ONT.

THE SPRING OF QUALITY.



SPRING or SOFT EDGE CUSHION FRAME
For Buggies or Other Vehicles. Built of the Highest
Grade of Steel Wire.

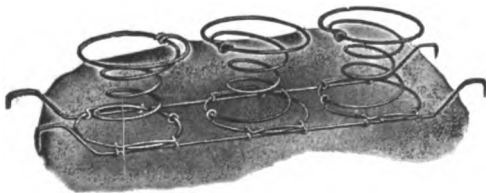

STRIP FOR WOOD OR BOX FRAME

THE F. H. LAWSON CO.

CINCINNATI, O.

Manufacturers of

Metal Buggy Seats

FLEUR DE LIS PATTERN

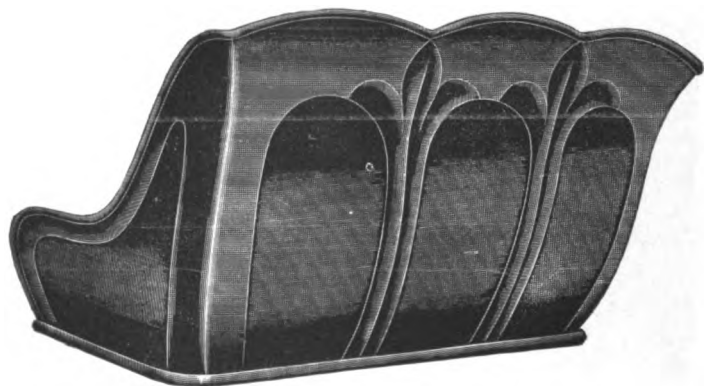

NEW STYLES—ALL SIZES

STRONGEST—NEATEST—BEST

No Solder Used

YOUR VEHICLE SELLS WHEN EQUIPPED WITH

LAWSON'S METAL SEATS

Write for Prices

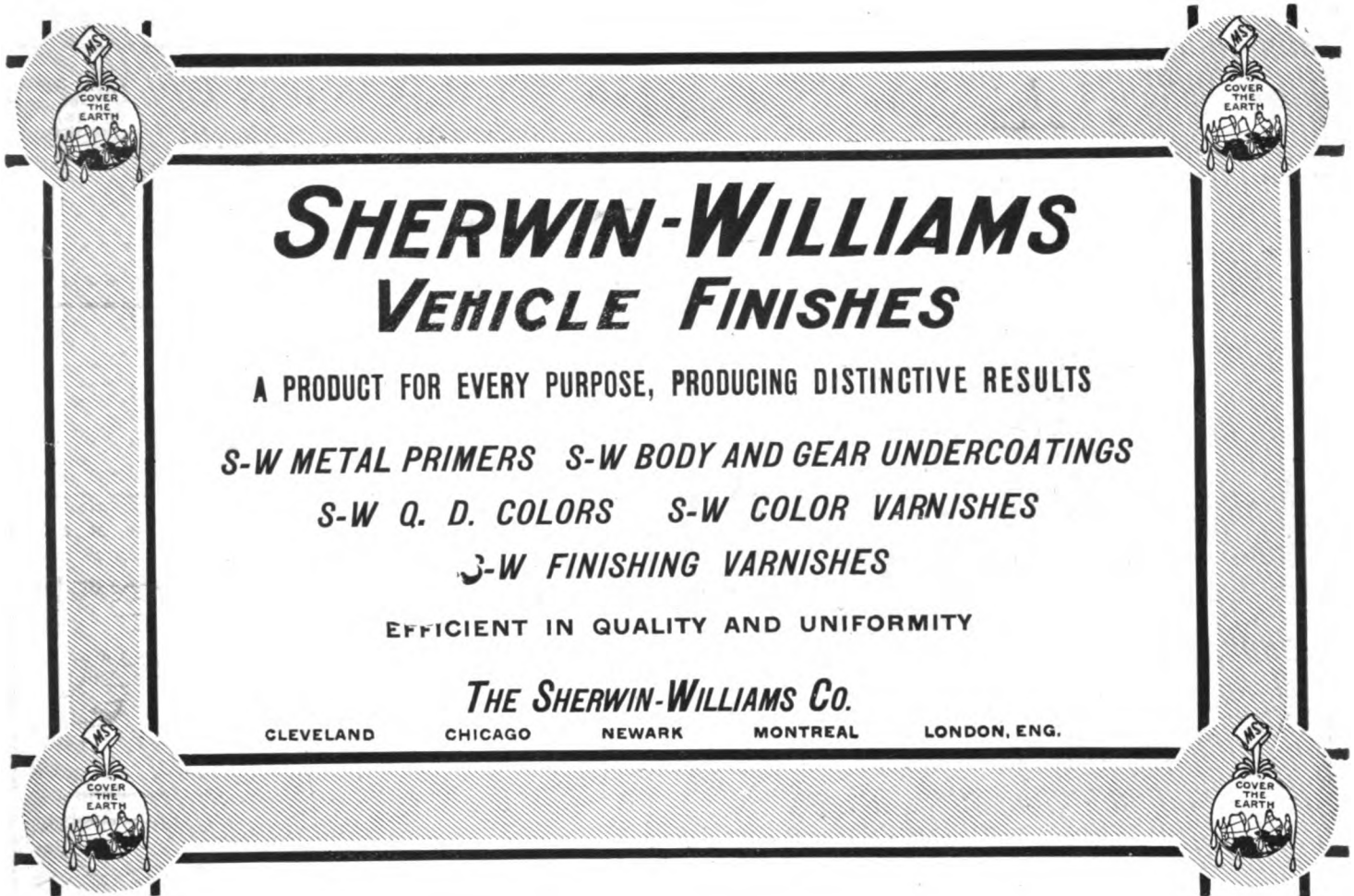

SHERWIN-WILLIAMS
VEHICLE FINISHES

A PRODUCT FOR EVERY PURPOSE, PRODUCING DISTINCTIVE RESULTS

S-W METAL PRIMERS S-W BODY AND GEAR UNDERCOATINGS
S-W Q. D. COLORS S-W COLOR VARNISHES
S-W FINISHING VARNISHES

EFFICIENT IN QUALITY AND UNIFORMITY

The SHERWIN-WILLIAMS Co.

CLEVELAND CHICAGO NEWARK MONTREAL LONDON, ENG.

WILCOX **F**INE
FINISHED
FORGED

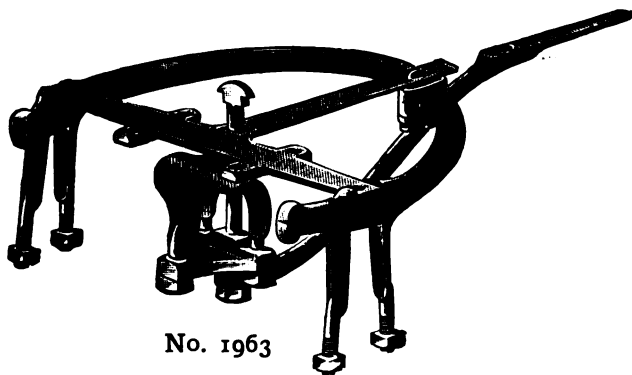

**Carriage Hardware
and Gear Irons**

Write us for Catalogue No. 11B

The D. Wilcox Mfg. Co.

**MECHANICSBURG,
CUMB. CO., PA.**

WILLEY'S COLORS

The **RECOGNIZED STANDARD**



C. A. WILLEY CO.

COLOR GRINDERS

and Manufacturers of Specialties in

CARRIAGE, AUTOMOBILE AND CAR

PAINTS

COLORS, VARNISHES, ETC.

HUNTER'S POINT, NEW YORK CITY

The WEST Hydraulic Tire Setter WILL CUT DOWN EXPENSE



Tires set cold in one minute. This machine saves time—does the work better and quicker, does a way with burned streaks. Only necessary to measure one wheel in a lot. Does not char the rim, and thus make the tire loosen prematurely.

Saves resandpapering of wheels. This machine is now increasing the profits of many manufacturers. Send for catalog and read about it.

WEST TIRE SETTER CO.,

ROCHESTER, NEW YORK

Established 1886

Correspondence School of Carriage and Motor Carriage Drafting

A thorough, practical tuition is given through this correspondence school. The theory and practice of construction, bookkeeping, perspective. Many men now hold good positions through taking the courses of instruction.

Principal, **THOS. MATTISON,**

Hillside Avenue, Bitterne Park,

Southampton, England

Author of "The Coach Body Makers' Guide," \$3.00; a practical treatise on "The Suspension of Carriages," "Bookkeeping," and other carriage building works.

WHAT IT IS

The American Harness and Saddlery Directory

The 1914 Edition

An extra painstaking revision of the names (and other information as below) constituting the Retail Harness Trade, has been completed for this year's issue of the Directory, and we think the work is so important and worthy that the

1914 Price Is \$5 Per Copy

and it is very moderate for what is offered in a work that is

Indispensable for Reference

for copying of addresses, and for all purposes usual in a directory.

Just a Sketch of Its Contents

The list of the **WHOLESALE** and **JOBGING TRADE** is so arranged as to make it convenient to separate the association members from those not so recognized.

The **RETAIL HARNESS MAKERS** of the United States and Canada comprise the principal part of the Directory, arranged by State, Town and County, and in the large cities, the street and number is given. Those rating (approximately) over \$1,000 are marked.

A list of **HARNESS DEALERS** as distinguished from retail harness manufacturers, is also given. The value of this list to those who solicit the vehicle, implement, hardware and department stores will be readily appreciated.

A list is also published of Export Commission Merchants, giving the class of merchandise they handle.

PUBLISHED BY

THE TRADE NEWS PUBLISHING COMPANY

PUBLISHERS OF "HARNESS"

24-26 MURRAY ST., NEW YORK

PORTER'S BOLT CLIPPERS
 "Easy" "New Easy" Allen-Randall



To Cut 5-16, 3-8, 1-2, 5-8, 3-4 Inch.

H. K. PORTER, EVERETT, MASS.

CARRIAGE—WAGON—AUTOMOBILE
 AND SPECIAL
DROP FORGINGS
 QUALITY—THE
 BEST

Richard Eccles Co., Auburn, N. Y.

PROMPT SERVICE.
 WRITE FOR CATALOG.
 SEND BLUE-PRINTS OR MODELS
 FOR OUR QUOTATIONS—IT WILL PAY YOU



THE FAIRFIELD RUBBER COMPANY

Manufacturers of

**Carriage Cloth, Imitation Leather,
 Automobile Cloths, etc.**

FAIRFIELD, CONNECTICUT

KEYSTONE BLACK FILLER
 MAKES A PERFECT
ROUGHSTUFF
 For Automobile Bodies and Parts

It fills the pores of Metal and Wood perfectly. Sandpapers easily and produces a fine, smooth surface that DOES NOT CRACK, SCALE NOR PEEL.

POMEROY & FISCHER, New York
 Selling Agents to Vehicle Trade

KEYSTONE PAINT AND FILLER CO., Muncy, Pa.

Cargill Service

has brought to the Cargill Company more Vehicle Catalogues than are made by any other printing house in America.

Cargill Quality is bringing The Best Automobile Catalogues to our plant for Complete production—watch for our imprint in the Season's best books.

THE CARGILL COMPANY

DESIGNERS ENGRAVERS  PRINTERS & BINDERS

Grand Rapids, Michigan

Carriage Mechanics

Desiring to improve their present Condition should attend the

TECHNICAL SCHOOL

FOR

Carriage Draftsmen and Mechanics

SUPPORTED BY THE

Carriage Builders' National Ass'n

The object of the School is to teach men to design vehicles and make working drawings, and to otherwise facilitate their work in the shop. Only those men employed in carriage or automobile building or their accessory trades are admitted to its privileges.

The classes are conducted in three divisions, viz.: Corresponding, Day, and Evening. The former is open during the entire year, while the day and evening classes are in session only from October 1 to April 1.

The tuition is moderate.

For prospectus and full particulars, write to the instructor,
ANDREW F. JOHNSON,
 20 West Forty-fourth St.,
NEW YORK CITY

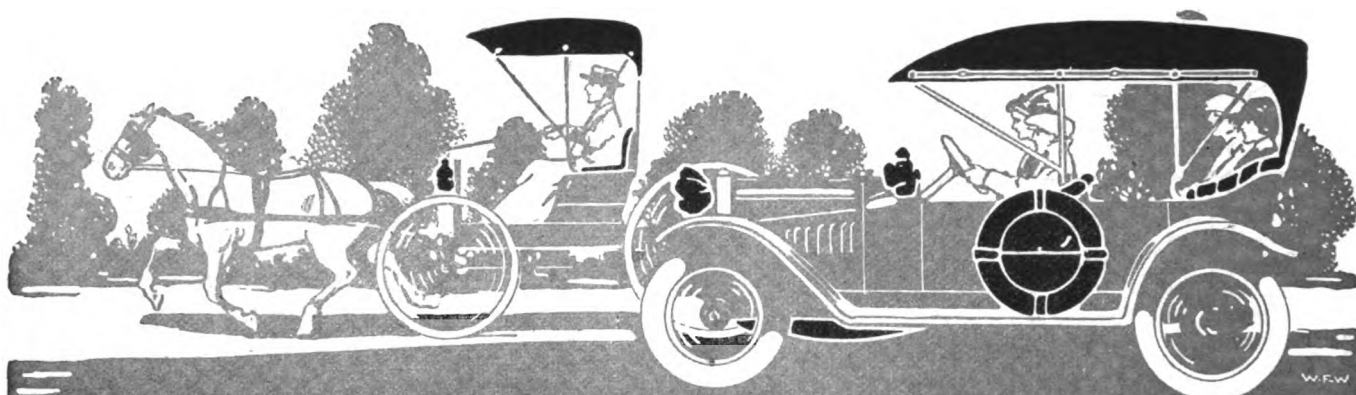

Learn More About The Leading Leather Substitute

Every carriage and automobile manufacturer—every manufacturer of carriage and auto accessories, storm curtains, aprons, lamp covers, tire cases, trunks, etc., should get and examine samples of

MERITAS

LEATHER CLOTH

Only by seeing the goods—by testing them—by noting the handsome, durable, non-cracking finish and the fine line of colors can you appreciate the high quality we have attained in the manufacture of a serviceable leather substitute.

There are styles, colors and finishes in MERITAS LEATHER CLOTH suitable for every carriage and auto trimming and upholstery purpose.

It can be had in muslin, duck and drill; dull or glazed; smooth or grained; in black and colors.

Sample book on request—write now and know more about the leading leather substitute.

Write
for
sample
book of
MERITAS
LEATHER CLOTH
NOW

The Standard Oil Cloth Co., Inc.

320 Broadway, New York

The Hub

Copyright, 1914, by the Trade News Publishing Co., of New York

Entered in the New York Post Office as Second-class Matter

Vol. LVI

JANUARY, 1915

No. 10

THE TRADE NEWS PUBLISHING CO. OF N. Y. Publishers of THE HUB

J. H. WRIGHT, *President*

G. A. TANNER, *Secretary and Treasurer*

24-26 MURRAY STREET, NEW YORK

Other Publications of Trade News Publishing Co.:

HARNESS (monthly).....per year, \$1.00

AMERICAN HARNESS AND SADDLERY

DIRECTORY (annual).....per copy, \$5.00

THE HUB is published monthly in the interest of employers and workmen connected with the manufacture of Carriages, Wagons, Sleighs, Automobiles and the Accessory trades, and also in the interest of Dealers.

Subscription price for the United States, Mexico, Cuba, Porto Rico, Guam the Philippines, and the Hawaiian Islands, \$1.00, Canada, \$2.50, payable strictly in advance. Single copies, 25 cents. Remittances at risk of subscriber, unless by registered letter, or by draft, check, express or post-office order, payable to the order of THE TRADE NEWS PUBLISHING CO.

For advertising rates, apply to the Publishers. Advertisements must be acceptable in every respect. Copy for new advertisements must be received by the 25th of the preceding month, and requests to alter or discontinue advertisements must be received before the 12th day of the preceding month to insure attention in the following number. All communications must be accompanied by the full name and address of writer.

FOREIGN REPRESENTATIVES:

FRANCE—L. Dupont, publisher of *Le Guide des Carrossiers*, 78 Rue Boissiere, Paris. Subscription price, 15 francs, postpaid.

GERMANY—Gustave Miesen, Bohn a Rh. Subscription price, 12 marks, postpaid.

ENGLAND—Thomas Mattison, "Floriana," Hillside avenue, Bitterne Park Southampton. Subscription price, 12 shillings, postpaid.

Entered in the New York Post Office as Second-class Matter

A New Tariff Advocate

Norman E. Mack, publisher of the Buffalo Times, and for many years chairman of the National Democratic Committee, has come out strongly in favor of tariff revision by the present Democratic majority in Congress along protective lines. Among other things he says: "We recognize that our system of tariff taxation is intimately connected with the business of the country, and we favor the ultimate attainment of the principles we advocate by legislation that will not injure or destroy legitimate industry."

Mr. Mack insists further that the manufacturer "is entitled to all of the reasonable safeguards he can have in the way of readjustment of such tariff schedules as it shall be shown necessary to revise in order to meet the requirements of the new situation."

Mr. Mack has long been looked upon as one of the leaders of his party and his conversion to the principles of protection will find many followers.

If the Democratic Congress would have the wisdom

to adopt and to follow up this suggestion, the Democrats would deprive the Republicans of their best and most effective ammunition for use in the campaign of 1916.

Rising Spirits

The biggest order for steel rails the market has seen this twelve-month is announced by the Pennsylvania Railroad. The road will buy immediately 150,000 tons, which is 18,000 tons more than all it bought in 1914. The New York Central is getting prices on 45,000 tons and is certain to want more later. With these two big railroads setting the pace, others are sure to figure more confidently and come forward with substantial orders.

That the rise of spirits in railroad circles following the Interstate Commerce Commission's grant of an advance in freight rates would promptly show itself in renewals of equipment and a widening of operations was a foregone conclusion. There is every reason, however, why this spirit should not stop with the railroads but keep right on.

Business throughout the country has formed the habit of watching the railroads and the steel industry. The railroads are cheered up. Consequently the steel industry is going to be.

Let business, therefore drop the anxious eye attitude and fall to.

American Mules Going to War

British army officers have started in to purchase mules in the west on an open order, the extent of which is not known. The demand is for animals from 15 hands to 15.3 hands high, which is about the average height of the southern cotton mules. As the southern market is badly demoralized on account of the cotton situation, this new demand is bringing welcome relief to breeders, feeders and dealers. In ordinary times the cotton states buy about 125,000 mules annually. Whether the European war orders will make up for the falling off this year is not yet known, but, since the Boer war is said to have taken 106,000 mules from the United States, the market experts are feeling hopeful. Though prices so far have not reflected the new demand, it is expected that mule values will shortly begin to boom. At last accounts they ranged from \$100 to \$300, according to height and weight. Prices for army horses have advanced from \$15 to \$25 since the beginning of the war and are now going up more rapidly than at any time in the past, it is said.

A Person and a Personality

SENECA, a great Roman writer and philosopher, once said, "We complain that life is too short, yet we live each day as if it were a thousand years."

The life of the average individual is principally occupied in rendering excuses, making explanations, and in listening to idle gossip.

The average man makes but little of his chances, which assertion is proved by the fact that a few men in one day of eight hours often accomplish more than many men in a lifetime of seventy years.

Life is simply a matter of concentration. You are what you set out to be. The things you read today and the things you think today are the things you become tomorrow. You are a composite of the things you say, the books you read, the thoughts you think, the company you keep and the things you aspire to become.

So, then, here is a recipe for improving the individual and evolving your life into success. Time is your only asset. Each moment is a golden treasure and the way you spend it shapes your life as an individual.

If you would simply devote thirty minutes of each day to the study of some splendid idea, to the improvement of your mind, in obtaining a more accurate knowledge of your business, in studying the thoughts of some great man who has left the world better because of his having lived, in search of the secret of the success of great business men, you would in ten years' time evolve into a giant of intellectual strength with power to follow any plan or idea to final and positive success.

That is what you can actually do through the right investment of thirty minutes of each day.

Time knows no prejudices, makes no promises, keeps no records and asks no questions. You are here for a purpose and each moment you spend foolishly or frivolously is lost for all time—simply thrown into the waste basket of indifference. You come into this world from an eternity of which you know but little, watch the hour hand on the face of time for a little while and return to that eternity from which you have come.

Unless you know the value of each moment as an investment, each day that passes is only a stumbling block that sends you blundering on into the indifference, helplessness and decline of old age.

Then the question is—what are you going to do with each hour and what are you going to do with life? Are you going to drift through its wealth and beauty, satisfied with your inefficiency, incompetency, idleness and ignorance? Are you going to leave untouched the treasures of the world in which you live? Are you going to betray yourself and your chances?

Are you going to remain content with your own limited knowledge when you can keep in touch with the great thoughts and ideas of the great men who have influenced the world? Are you going to bury your head in your desk and shut out the light of experience and the success of other men?

In other words—are you going to be a failure and in the evening of life go down the other side without having accomplished some great and splendid thing? Are you going to use these thirty minutes each day, to know more, to learn more and to understand? It is up to you.

Opportunity is pounding a perpetual tattoo on your door and follows you with a club from the time of your rising to the time of your retiring. The question is—are you to be a person or a personality?

The way you invest this half hour is going to decide, and your life's work will say if you have been a success or if your life has been a travesty—a mockery filled with idleness, indifference and uselessness.

Do you believe in your work, in loyalty to your employer, in devotion to your business. Do you believe in honest service, in honest thought, in the divinity of the thing you do or the things you sell? Do you intend to be an individual or a nonentity? As a man it is absolutely and entirely up to you. Are you going to get busy and when do you expect to begin?

No Fear of Horse Shortage

It is said that the United States army authorities are in a panic for fear it will soon be impossible to find enough horses for their own purposes if the British and French military buyers keep on taking them out of the country. As the European buyers have paid considerably less than \$150 on an average for the animals they have purchased, the market experts say that no one need be alarmed about a shortage of good horses. Most of those shipped abroad are said to be below the grade of "Southerners," which are the cheapest horses known to the trade. J. C. Miller, of the 101 Ranch, has expressed the opinion that 1,000,000 horses suitable for army purposes could be found in the United States if required.

Way Paved for Business Revival

Now that the Interstate Commerce Commission has granted an increase of five per cent. to the eastern railroads, the Federal Reserve system has been successfully launched, the President in his message to Congress has indicated that there will be no more repressive business legislation, and the balance of trade has turned in our favor, there should be an optimistic view taken of conditions by business men generally, and an appreciative revival of business in all lines during the next few months.

More than 4,000 jacks and jennets are said to have been registered in the United States within a year. As these animals are used exclusively for breeding purposes, the number indicates a veritable boom in the production of mules. At a recent auction sale at Smithton, Mo., a yearling jack brought \$1,700, an older jack \$1,825 and a jennet \$1,300.

The foreign trade figures show a balance in favor of the United States of \$79,299,410 for the month of November, while the balance against the United States in August was \$19,400,406. If the war lasts any length of time it is possible that we may eventually own ourselves.

TIME FOR SANE OPTIMISM

Hard Times Can Be Counteracted in a Large Measure by Tightening One's Belt

The following extract from a speech before the Pittsburgh Publicity Association by C. M. Lemperley (advertising manager of the Sherwin-Williams Co., Cleveland, makes interesting reading:

The business men of a small Ohio town—150 in number—were holding a little dinner. They were inclined to look at the business situation through favorable eyes. One man rose to his feet and said he would like to show, by a practical demonstration, how even the smallest merchant can aid prosperity by keeping his head with him at this time.

He took a five dollar bill from his pocket and bought five dollars' worth of coal from the coal dealer, who sat at his left. The coal dealer turned to the grocer next to him and bought five dollars' worth of groceries. The grocer turned to the hardware man and bought five dollars' worth of hardware. The hardware man turned to the dry goods man and bought five dollars' worth of dry goods. And so the chain of business men

around the room passed that five dollars one to the other until \$460 worth of sales had been made within a very few minutes. The point of it is the five dollar bill returned to its original owner, and yet every merchant in the room had made a sale and received his money for it. If you multiply that by cities, states and nations you can soon see that if all of us would continue our normal purchases, instead of getting panicky, there would be no hard times. If one of the men in that room had held up the five dollars and shown signs of cold feet it would have affected the prosperity and the financial transaction of all the remaining 149 men. I think this is a very good illustration as to just why we should do our best to maintain normal business transactions in our daily lives.

At that same meeting a butcher got up and made some remarks. Some one asked him if the high cost of living had not affected his sales. He said, on the contrary, he was doing the best business of his career. He told how he sent out weekly letters and bulletins advising his customers that it was true, prices were up high. But he cautioned them to buy wisely and carefully. Then he went on to suggest what cuts of meats were economical at that time and were very good for the purpose.

A paint dealer told how, with everybody else pessimistic in the town, and with many houses unrented, he made capital of this by going to see the owners of these unrented houses, and proving to them how their houses would not only rent quicker if they were painted, but would bring more rent. His sales are on the increase.

I want to bring out the point that in these troubled times leadership counts in the business world. I mean by that, that this is no time for weaklings at the head of great business institutions. I want to quote briefly a statement our president, Mr. Cottingham, made the other day with regard to business conditions.

"I believe the outlook is very favorable. It surprises me constantly to see the mental attitude of so many men in times of business depression. In this organization in times of depression we put forth not less energy but more energy. I believe it is a time for sane optimism—I don't mean foolish optimism, but I believe that there are enough favorable conditions in the country to make a man sanely optimistic. In this organization the year which just closed September 1, was the best in our history. The profits were satisfactory. We have high hopes of good or better business each day. Since our new fiscal year started we have gained for October over the largest October in our history. In November our weekly sales are showing up away ahead of last year which was a splendid November."

I believe that this is a time when executives should get into closer touch with their selling organization, and keep that selling organization selling. What good is a selling organization off the road?

After all, don't you agree with me that hard times can be counteracted, in a large measure, by tightening one's belt, straightening one's shoulders, and wearing a smile instead of a frown.

DOES THE MULE MENACE THE HORSE?

It has been pointed out recently that, whereas there were 2,758,000 mules in the United States ten years ago, there are now 4,449,000, a gain of more than 60 per cent. in ten years. This has led to the prediction that, while the horse has weathered the assault of the automobile and the auto truck, the great menace to his future now is the mule.

It is claimed that the early maturity and remarkable longevity of the mule, his comparative freedom from disease and the rarity with which a mule is found with unsound legs, make him a more economical proposition on the farm than the horse. It is stated that the man who uses mules will have to renew his work team only once where the user of horses will have to do so twice. Instances are mentioned where farmers have

worked their teams of mules for 20 years without finding it necessary to pay out a cent for the services of a veterinary. It is also claimed that only two-thirds of the feed necessary to keep a horse will be sufficient for a mule doing the same amount of work; also that, having much harder hoofs than a horse, the mule being used on the farm need not be shod for more than a brief part of the year. But admitting the justness of all these claims, what then? Without horses there would be no mules. All over the south and southwest, where the greater part of the mules in this country are raised, their breeders are using the best mares they can possibly get to raise the mules from. Sound and full-blood draft mares are used to produce the big, heavy mule for city use. For the lighter weight mules, both trotting bred and thoroughbred mares are used; and the supply of such mares hardly suffices to fill the demand. Let the mule supply increase. The long-eared hybrids not only relieve the horse of a lot of drudgery, but the greater the demand for them, the more mares horse breeders will have to raise to stock the farms where mule-breeding is made a specialty. That it pays owners of good mares to use them for mule breeding, the prices good mules sell for are sufficient proof. Not long ago a Kentucky firm sold a big pair for \$1,000; and it is said that a contractor working on the Ashokan reservoir contract near New York, has 100 teams of mules at work which cost him upwards of \$600 each.

A MULE OF PERU

This marvelous feat was related to a lady traveling in Peru via trail and mule train, by the priest who claimed to have owned the daring resourceful animal he told about. In Peru many of the trails are mere ledges cut out of the solid rock, the precipice falling away for hundreds of feet to the river below on one side and rising equally steep and straight on the other side.

This priest was journeying on his mule over just such a trail, when suddenly to his horror on rounding a bend, he saw that an avalanche had swept nearly 20 feet of the trail completely away. The trail was narrow; he could not turn and he dared not dismount. Far below roared the river, above reared hundreds of feet of sheer rock. Giving up for lost, he took out his beads and began to say his prayers before going to meet his Creator.

The mule in the meantime had been viewing the situation intently. The priest felt him move, then the animal reared straight up on his hind legs. His master thought he was about to plunge over the edge and clung to the saddle thinking the end was near—but no, slowly the mule turned on his hind legs, turned until he was facing back down the trail. Then he came down upon all four feet again and commenced the return journey.

It was a wonderful display of intelligence and courage and one that is scarcely credible, but the priest vouched for its truth while others admitted that the trail had been swept away and that the mule had in some way brought his master safely back. Later, to the priest's great sorrow, the valuable animal was stolen and he never saw him again.—W. G. Rushworth.

A PICTURE IN CONSTANTINOPLE

In a graphic picture of life in Constantinople a Russian artist, who has returned from that city, dwells on the activities of Enver Pasha. From morning to evening, says the writer, he is seen flying around the city like a whirlwind. Suddenly one hears in the street a shrill motor horn, and all the passersby cling to the walls or the railings of bridges. Then along comes a galloping company of horsemen, with drawn swords. Enver Pasha himself follows. In spite of the motor horn, he does not ride in a motor, but in a carriage drawn by a pair of very fine black horses. A footman sits by the side of the carriage and sounds the motor horn, which is a present from the Kaiser. The Kaiser sent his faithful friend a gorgeous motor car, but

Enver Pasha, in spite of being a young Turk, retains the old Truk's fondness for horses. So, in order to retain something of the present of his august friend, he makes use of the motor horn. Behind the carriage there are two more lines of horsemen carrying short rifles instead of swords. The whole produces a picture of alarm and restlessness.

WORKING DRAWING OF LIMOUSINE LANDAULETTE

Drawing on opposite page

Among the front rank cars in the motor industry, the limousine distinctively, and the limousine landaulette, hold the leading position whether as carriages of luxury or of lesser degree.

The design shown on opposite page is a limousine landaulette. Of the two vehicles it is the most popular, because, like its prototype the landau, it makes an open and closed body, and so feeds an economical desire in motorists to possess the advantages it gives in this characteristic convenience.

In the working drawings which *The Hub* publishes, slavish copying is scouted. The elements that obtain in the world of fashion are, of course, embodied, but design is kept individual. The idea is to lead and not to follow, which must of necessity be the goal in ever advancing creative grit, and to continually lead to the ideal to be attained on the horizon of excellence and perfection.

In making these explanations as to what is deemed the best motor body food we are not to be understood to be discouraging legitimate attempts in real progress of design, but we declare an unbending attitude against the introduction of freak designing.

As has been pointed out on many occasions there are laws to be followed in designing as there are in all that nature produces in her varied world. And if nature is studied in all things whether of art or mechanics, there are exactions which, if violated or disregarded, recoil upon the efforts as distortions of those who labor in darkness and wonder why their handiwork is barren in the things that take because of their incorrectness in outline and construction.

The design herewith is fitted with full landaulette openings behind, while the front body is fitted with canopy hood and strung to position with side joints. This provision in front gives a light and aerial cast to the compact massiveness of the body.

The hind body is fashioned with heavy quarters bound by a continuous controlling moulding line. The top quarter is also spaced in heavy waist belt panelling forming the elbow. The side light is narrow but deep and drops into the quarter when the head is down.

Fig. 1 shows the design complete from which a full size drawing can be put upon the blackboard. Fig. 2 shows the half section of back body from which all cross measurements can be taken, and the turnunder pattern fully made to line. The section shows the design of the panelling and light to head leather.

Fig. 3 shows the half plan or "cant" of the body and the full width of the bottomside and the amount of projection over the side of the chassis and its bearing on the chassis and the cross-bar framing. The points of return contour are also shown here.

The sizes are: Length of body on chassis, 8 ft. 7 in.; length of hind quarter on elbow line, 29½ in.; depth of ditto, 30 in.; width of door, 24 in.; width of front quarter, 19 in.; width of door, 19 in.; width of scuttle quarter, 11 in.; the depths of these are in line with the body quarter, viz., 30 in.

Width of back of body, 44 in.; over center on door line, 55 in.; back light, 24 x 20 in.; top back quarter light, 28 x 10½ in.

From these points of measurement and the design of the body an experienced man will have no difficulty in building the body right off the draft, as the various sections show very clearly the points of outline construction.

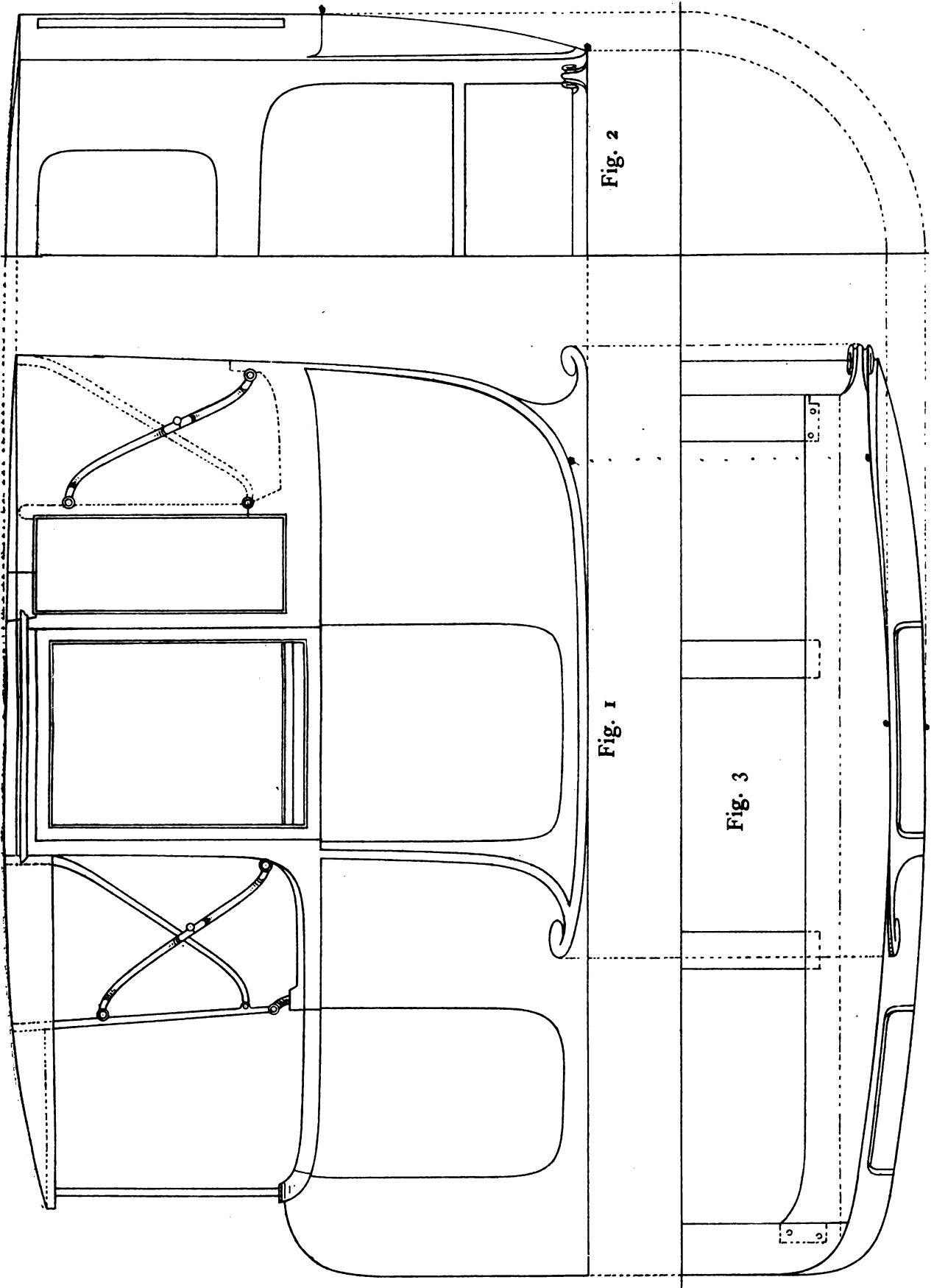

Fig. 2

Fig. 1

Fig. 3

WORKING DRAFT OF LIMOUSINE LANDAULETTE

Described on opposite page

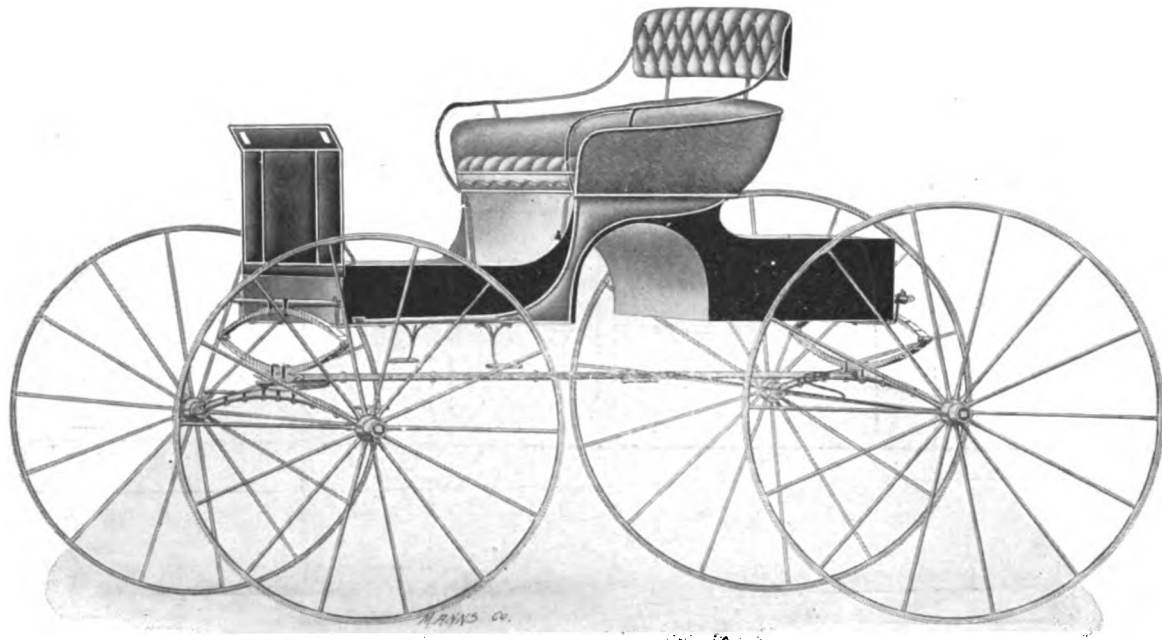

CUT-UNDER DRIVING WAGON, SOLID BENT SEAT
Built by Luth Carriage Co., Cincinnati, O.



TRIPLE PANEL AUTO SEAT BUGGY
Built by W. A. Paterson Co., Flint, Mich.

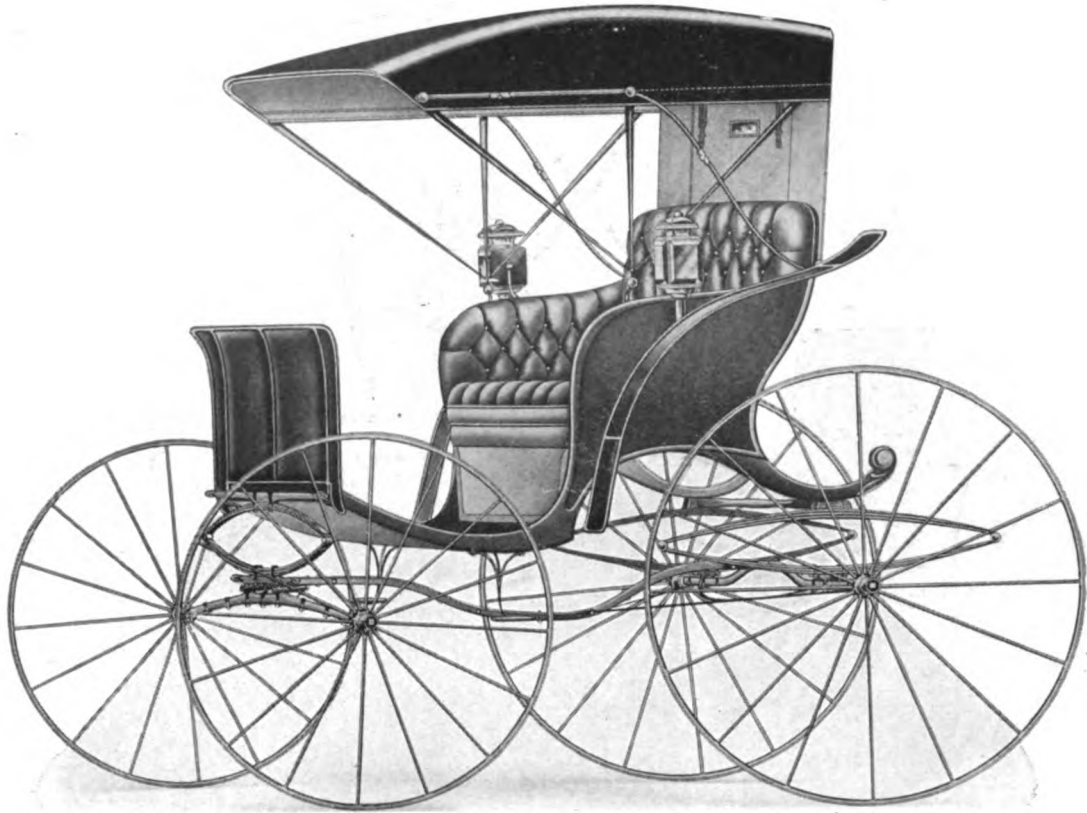

SPIDER PHAETON
Built by The Sechler & Company, Cincinnati, O.

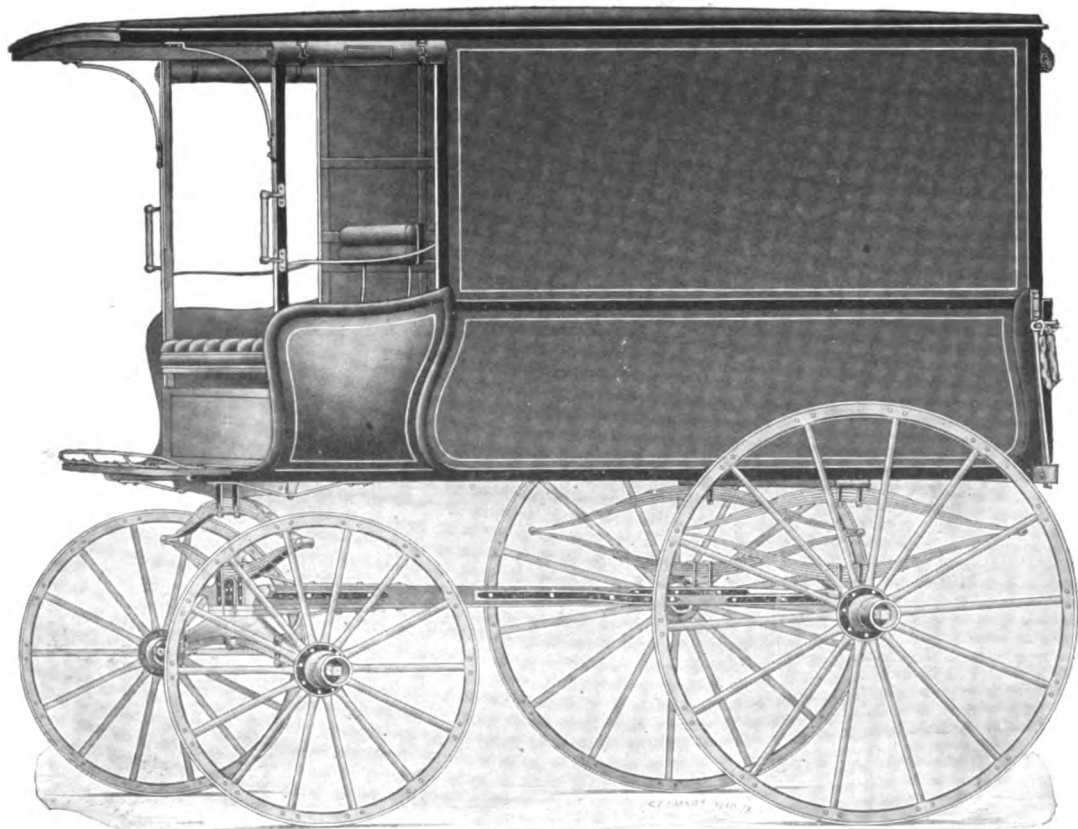

FANCY PANEL DELIVERY WAGON
Built by The Martin Carriage Works, York, Pa.

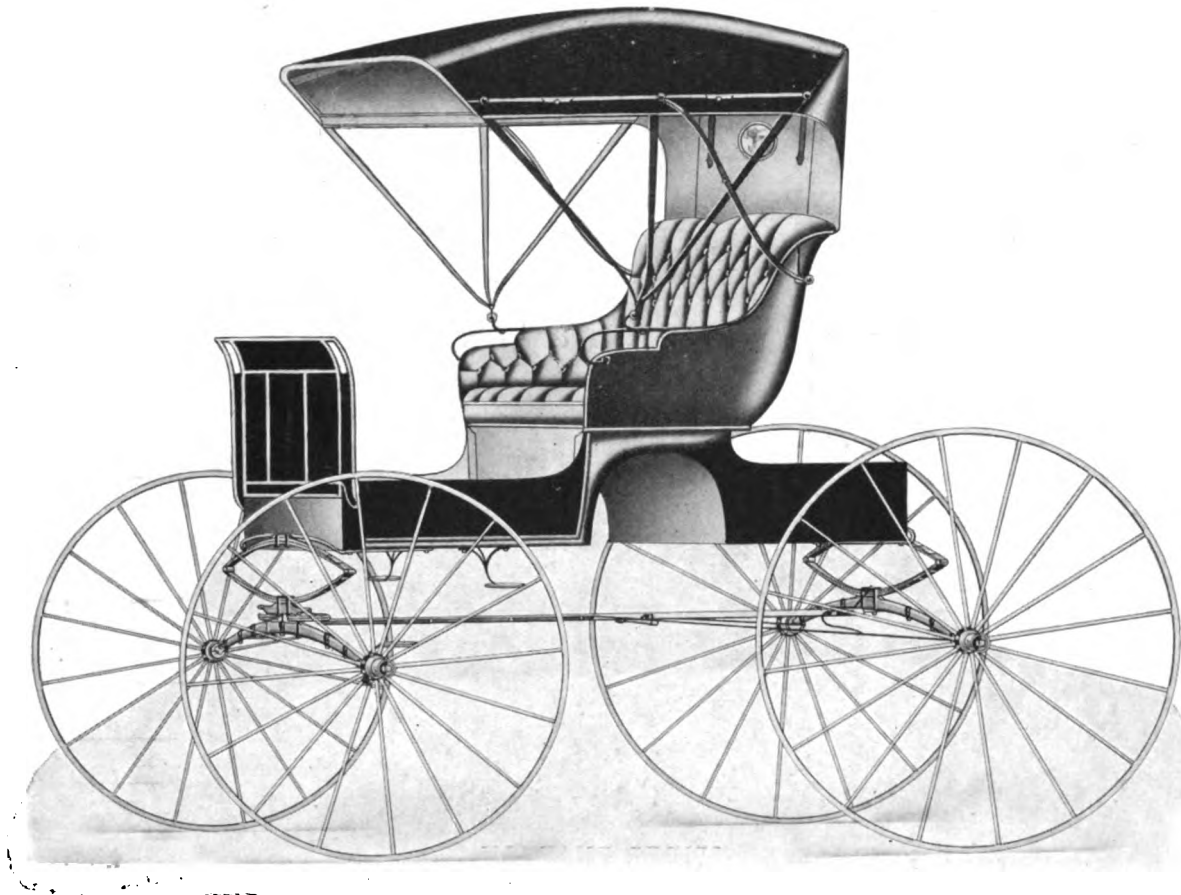
**CUT-UNDER BUGGY**

Built by The D. M. Sechler Co., Moline, Ill.

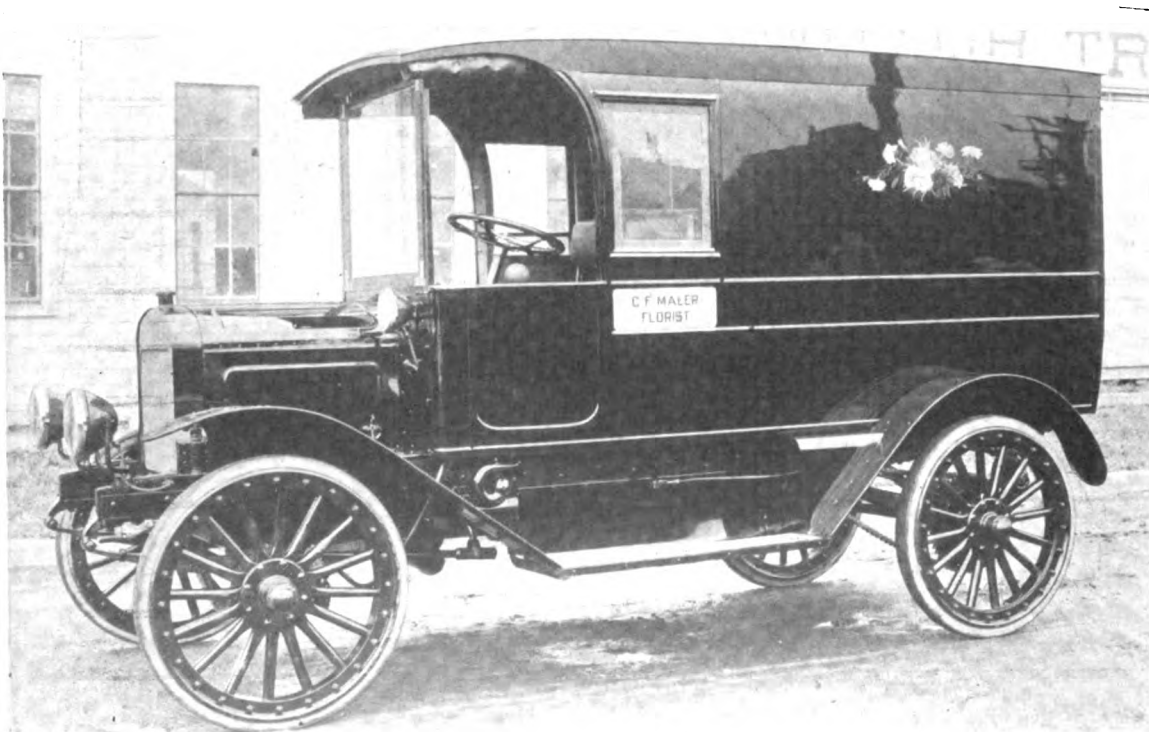
**MOTOR TRUCK FOR FLORIST**

Built by Brockway Motor Truck Co., Cortland, N. Y.

The 1915 Automobile Show

The "Magnetic" Car and Eight-Cylinder Engine Make Their First Appearance and Attract the Crowd

FEATURES OF NEW YORK AUTOMOBILE SHOW

Fifteenth Annual National Automobile Show.
 In Grand Central Palace, Lexington avenue and Forty-eighth street, New York City.
 Open for one week, January 2 to 9.
 Total Number of Exhibits—336.
 Different Makes of Passenger Vehicles—Gasoline, 81; Electric, 6.
 Motorcycle Exhibitors—13.
 Accessory Exhibitors—236.
 Total Number of Cars Shown—528.
 Lowest Priced Car—\$295.
 Highest Priced Car—\$6,000.
 Estimated Cost of Exhibits—\$3,560,000.
 Decorative Scheme—A Persian Palace Lobby—A California Outdoor Setting.
 Show Colors—White, Gold and Crimson.
 Exhibits of Famous Racing Cars and Trophies.
 No Commercial Cars Shown—Special Information Bureau for Commercial Vehicle Manufacturers.
 Auspices of the National Automobile Chamber of Commerce, Incorporated.

The new show season led off with the performance staged in the Grand Central Palace as has been usual for the past few seasons. The attendance seems to have been a large and paying one, but if the few comments we heard from those interested in sales are a fair criterion of the general experience, then the results in money have not been satisfactory. The consensus of views seems to lean in favor of the Chicago show, which is the next scheduled, as the one where the results are to be had that makes it worth while to make a show.

So many of the visitors in a large city like New York are dream-owners of cars. And then again there is such a large number who have fifty cents that they are freely willing to expend just for the pleasure of an idle curiosity. Salesmen appear to be acquiring an intuitive knowledge of the idler class, judging from observation, and we must say we saw some instances of a rudeness and indifference that may have been a natural result of boredom, but could not be quite excused on the score of politeness or good salesmanship.

The purveyors of accessories seem not to have gathered in such large numbers as in some former shows, and all of those that we asked to express an opinion were not convinced that it was worth while to display goods, and they certainly appeared to be careless whether the general visitor stopped to examine the wares or not. There were some of the accessories well worth attention on the score of both merit and novelty.

If the general impression of the show could be summarized in a word, it would be standardization. It would be possible to run the gamut from the very reasonable in price to the very

expensive, and the keynote would be sameness of practice, but difference in quality.

The six-cylinder engine now having a great vogue, it is common to find it built into the plebian car as well as the aristocratic pretender and so well has the engine building been standardized that there can be little question that satisfaction would be the portion of the owner even if the price was moderate. As to some of the pretentious machines, the refinement is something to wonder at, and in some cases so many refinements, so-called, are added, that we are of the opinion that the owner-operator would have a hard time keeping tabs on everything he ought to do to keep the wheels going round. In some examples, it would seem as if there was too much of this.

The Really New Thing

It is natural to expect to find the motive parts of the apparatus better than ever because the era of novelty seems to be in abeyance waiting for the new impulse that is to make for greater simplicity with fully as much effectiveness. The one beacon light of this kind that blazed out was the really new "Owen Magnetic," a record maker, probably along the newer path that is to be followed in the future. We may as well consider this new car at once, and the first thought is why was it not done long ago, which is, of course, easy to the one who has only to consider the completed result. The idea is the simple one of combining magnetic with gasoline practice. This is how it is done: There is no mechanical connection between the engine and the gear system, the power is applied by magnetism acting in air space. The engine operates the dynamo, which is in the position usual to the flywheel. The electric motor is in the position commonly occupied by the transmission box. The mechanism is under complete control from the steering wheel, and it amounts to pushing the lever around the circle to any point that means crank, charge, spark, and speed to suit. Each time the lever is at neutral an electric-magnetic brake may be operated, making three kinds of brake on the car. This last exerts no pressure on the mechanism, because there are no parts in mechanical contact. It is done by the "juice" of the motor field preventing the armature revolving more than a fixed number of revolutions to the minute. This makes a very safe and effective brake. Its value in coasting down hill under speed control makes it shine by comparison with the band variety of repression.

If there are no gears then it is plain that a large amount of expensive junk is scrapped, and it is also plain that such a machine has all the flexibility of the electric, with none of the drawbacks of heavy batteries, with small radius of action. This is an example of the directness and simplicity that we have always maintained would be forthcoming in its own good time, and it points to the possibilities of a future free from "troubles," when even the ladies without knowledge may drive as well as the most expert. That will be real automobiling. There is no need of the added self-starter and all the clutter that has been devised to make control of a machine from the seat a possibility. It is the really new thing. In fact, taking this and the

Cadillac eight, and the rest of the show could have been reasonably dispensed with so far as motive power elements are concerned. The remainder was merely "leather and prunella." Nice, well made, well done, commonplace so much alike in many instances that an owner without a distinguishing number or style of painting would be put to it to tell his car from another.

The New "Eight"

The new Cadillac "eight" is a very nice car, indeed, from every point of view. It deserves the prestige it will secure, but as to the novelty of it, it is not mechanical, but temperamental, as they merely looked toward France, saw what De Dion had already thought out and made commercially successful, and saw it first so far as America goes—and they have been slow about it at that. Closely following the trail comes the King, also the Perkins with eights, and at prices that will appeal to the savings-bank class of customers, as they can afford them, and leave something still to draw interest. The Perkins is just the engine itself as a sales proposition for the manufacturer who wants to turn to the newest without making expensive factory changes in the equipment, so it is fair to presume that the next wave of fashion will be in the eights direction, as it is a direction that has much to commend it. It shortens the wheel base for one thing, and it is a desirable thing. It is, without question, more flexible than the six, so it has quite a "drag" in its favor.

The other interesting state of mind was the voluminous advertising of the Ford by all and several who were hoping to make a dollar by the devices that, added to it, would make it almost sit up and bark for a bone. This was Hamlet with the prince left out, certainly, but you could not forget the personality of the prince. It was a most flattering testimonial to popularity, especially as the Ford people over their sign-manual characterize all these tricks as "junk," and say the car is better off without them, and that they are simply a means of getting money for no useful end.

We think we have mentioned all but one of the considerations that occur to the beholder in a casual examination, one that is more or less impressionistic. The last and important one is the fine value for a dollar in the little cars for little money. The latest, the Dodge, is mighty good all through for something under eight hundred. Not an idea about it above the common level, but lavish quality of material not expected at the price, and thoroughly good as a piece of shop work. It is mighty nice to be in the position of The Hub where these observations may be made however it may hurt pride of endeavor. This is another and nicer way of saying it is very comfortable to be able to write the truth without detriment to the revenues, a thrall that makes all the automobile journals mainly the echo of the sound of the ringing coin.

The New Dort Car

The Dort car interested us sympathetically because in it we have still another carriage man who has won his spurs in the cheap buggy trade going after the automobile coon with a vehicle along the lines that have made the cheap buggy so admirable, that is, much of value compressed into little price. We heard it said by one who asserts he knows, that it is Mr. Dort's idea to develop the sales of this car not alone in his own selfish interest but also for the benefit of those of his lieutenants who have stood in the trenches through all the business campaigns of their leader. If this is the fact, it is a fine tribute to the quality of mind of a successful man. May the sales flourish like a field of weeds! The other dicker little gadabouts look their parts, and really, though very reasonable in price, they are worth no more than the price, and in some instances not as much, in our opinion. As for features, the fitments impress one with that sense of sturdiness that is to be observed in mechanical toys. One even dislikes to see the demonstrator become too enthusiastic, for fear something will give way.

Now, as to the body design, painting, trimming and such like matters. Streamline is the word they conjure with. It seems to make no difference if a vehicle is designed as a town car with inclosed body, and that it might graciously be permitted by the traffic cop to attain a speed of perhaps 20 miles, yet it must be streamlined, or no sale! Looking at the automobile as a locomotive car, the streamline has its reason. It subdues opposition, like the traveler who bends his head and body to the gale. A vehicle that gives the idea of something wrong in its front part, by reason of which the body has sagged out of line, does not look pretty. By the use of metal and metal-working machinery designed for the purpose, the sweeps, contours, etc., have been handled with much skill. Even capacity has been increased without it being made too apparent in the work on the body. It has become a steel or an aluminum clad as much as the locomotive car. The standardization work shows in this department very strikingly. There is as much originality of design as in a Hercules buggy. The sameness all through the show in body designing was most timesome to the looker-on.

Trimming and Painting

In the trimming the stunts were very meritorious. Even the cheapest split leather was handled with dexterity and made to look good. Some of the substitutes for cheap leather quite outshone the leather in coloring and fabric, and was a case of the substitute being the better part. We have little doubt, it will wear better, as nothing is lower in the scale than a cheap leather split. However, it looks well when new, and that is the time a sale is made. In the fabric trimming, much luxury as well as taste was displayed. Nowadays there is a delightful feeling that there is not a chance of running into any of those wedding cars, and actress primrose horrors that at one time were certain to be among those on view. Divided front seats are more in evidence than common. Quality of all material in the pretentious cars fine.

The painting, as painting, is generally very good indeed. Judging by surface conditions all the good painters have gravitated to the automobile shops. The combination of colors is good. It is said that a man wearing dark raiment is safe to present himself at any function, and not appear ill dressed, or over dressed for the occasion. The automobile industry seems to have adopted that idea, as the colors are mainly sober and subdued, and the striping of the hair line kind, affording just the shade of relief wanted. Once in a while there is a big splash of color, like a yellow body, but not often. All black among the tin-can grades has the decided call, which is the best of judgment, it seems to the writer. All this, with the similarity of body design, lends a sameness to the exhibition that is monotonous, but it is a restful color monotony, and a decided change for the better. Wire wheels are much in evidence over previous seasons, and have a light and graceful effect. Tires seem to be used in some relation to the burdens they are called upon to support, something that was beyond the maker's ideas of true economy in earlier days when the buyer had not been to school.

There was a brave show of electrics, well upholstered, and representing the high lights in that trade. Somehow the general effect of the cars in this class we saw, was broad and dumpy. The lack of length accentuates the broad look in this class of work. The trimming in all examples was very nice—real boudoirs. It only needed the lady in the pink domino, or the pale blue peignor to make the thing look very theatric, especially with the top, side and foot lights.

Well, there is the show as we glimpsed it. Very fine display. We only have one wonder, and that is not born of this show: it is why do people pay something merely to go to a repository to look at a lot of vehicles that they can see without cost any day in the week along Broadway?

Now as to the Accessories

C. Cowles & Co. had a brave display of lamps new in pattern

and graceful in design. But the star feature is a two-way vehicle telephone as compact as a folded bank note, by use of which the passenger may both speak and listen to the sounds from the other end at one and the same time. It is very neat and "ladylike," and will be used largely in fine equipment, we think.

The one-man-top idea has come into its own. It reminds us of the instructions of the Dutchman to his painter: "Paint mine wagon enny color so long you paint him red." The one designed by that clever thinker, Black, of the Cleveland Hardware Co., is going some when it can bag 70,000 sets orders for one manufacturer. But there are others.

The F. S. Carr Co. is making a ten strike with the "Neverleek" material for tops. It is such a good all round fabric that it is highly regarded as a trimming material, too. Commodore Beatty was on the job.

The English & Mersick Co. had a brave display of lamps, carriage locks and hardware with Impressario Billy Bryan keeping the orchestra in tune.

The West Steel Casting Co. has arrived with a really good cast steel wheel for heavy trucks. It is a stunt to make a wheel of this kind stand up, as many who have tried it know. This seems to be a really serviceable wheel.

A queer little thing coming under the motorcycle class is the Autoped. It looks like a very exaggerated roller skate carrying a platform between the wheels about four inches from the ground. A one-cylinder four-cycle engine is attached to the front wheel, and the steering post is hollow to carry a charge of gasoline. Even the miniature wheels have demountable rims. The man starts it up, stands on the platform supported by the tandem wheels, and skids about the country in a standing position, grasping the flexible steering column in front of him. As he inclines it, back and forth, so the thing travels. It will go at 60 miles an hour (so stated), climb hills and do everything except jump a hoop.

Of oils and greases there were enough to lubricate the palms of even a Tammany heeler. Among them the Baum's Castorine had a good display under the control of Mr. Clayton Mowry and L. B. Friedensen.

Most of the exhibitors at this show are also booked for Chicago.

The tire men were not very numerous, and the varnish makers seem to have given up the game. Wonder it is wasn't done long ago.

**EIGHT CYLINDERS THE LIMIT,
SAYS ENGINEER**

With the gradual increase from time to time in the number of cylinders in the automobile power plant one of the questions occasionally heard is, "Where is it going to stop?"

Automobile history records the steps from the one cylinder to two, from two to four, from four to six and from six to eight, the latter being represented by the latest Cadillac production.

Writing on this subject in the Autocar Imperial Year Book, published in London, Mr. W. G. Aston, an English engineer, comments in these words:

"It may now be asked why not continue to multiply cylinders and gain an even better result. The answer to this is very simple. Eight cylinders are only two more than six, and the improvements which they produce are very marked. Now the next size of engine would be twelve cylinder, or half again as many cylinders, which would not possibly give 50 per cent. better result, and so on. A glance at the torque curves will show that as the cylinders are increased the difference in the characteristics of the curves tends to become less marked. Drawn to the same scale, the curves of a 16 cylinder engine would hardly be distinguishable from the twelve, and twelve scarcely distinguishable from those of the eight. For ordinary purposes, therefore, the eight may be considered to be the ideal as well as the practical maximum, for motor car work at all events."

EXHIBITORS IN PALACE SHOW

The full list of cars and motorcycles on exhibition in the Grand Central Palace follows:

Gasoline Cars

Allen	Haynes	Marmon
Apperson	Herff-Brooks	Oakland
Argo	Hudson	Oldsmobile
Auburn	Hupmobile	Overland
Briscoe	Imperial	Owen
Buick	Interstate	Packard
Cadillac	Jackson	Paige
Cartercar	Jeffery	Peerless
Case	King	Pierce-Arrow
Chalmers	Kissel	Pilot
Chandler	Kline	Premier
Chevrolet	Krit	Regal
Cole	Lewis Six	Remington
Crawford	Lexington	Reo
Cunningham	Locomobile	Saxon
Davis	Lyons-Atlas	Scripps-Booth
Briggs-Detroit	McFarlan	Stearns
Dodge	McIntyre	Stevens-Duryea
Durant-Dort	Maxwell	Studebaker
Enger	Mercer	Stutz
Fiat	Metz	Trumbull
Fischer	Mitchell	Twombly
Franklin	Moline-Knight	Velie
Gadabout	Moon	Westcott
Garford	Pathfinder	White
Grant	National	Winton

Electric Cars

Anderson	Rauch & Lang	Waverly
Baker	Ohio	

Motorcycles

Indian	Henderson	Schickle
Yale	Gerhart	Merkle
Emblem	Pope	Thor
Harley Davidson	R. S.	

IMPORTERS' AUTOMOBILE SALON

Many Makes of Cars and Bodies Make the Show at Hotel Astor Interesting

Nine makes of cars and two lines of automobile bodies were exhibited at the eleventh annual Importers' Automobile Salon, which was held in the ball room of the Astor Hotel during automobile week. The makes shown were De Dion Bouton, Fiat, Isotta-Fraschini, Lancia, Minerva, Renault, Rolls-Royce, Simplex and Sheffield-Simplex. Holbrook and Brewster had separate body exhibits.

The salon was held by the Automobile Importers' Alliance, Inc., of which Emanuel Lascaris is president; T. Adams, vice-president, and Stefan J. Kjeldsen, secretary-treasurer. Mr. Kjeldsen also acted as manager of the salon.

The magnificent bodies mounted on the various chassis commanded the principal attention of salon visitors. Not only were there distinctively new ideas in design, but many novelties in upholstery, fittings and tops. There were even new paint and varnish effects. The coach makers are lavish in their use of inlaid interior woodwork and rich upholstering in fine cloths and leathers.

One of the most attractive exhibits was that of the Renault selling branch. The company's 50 horsepower, six-cylinder chassis embodies many improvements and refinements. Particular attention was given to the installation of the lighting dynamo and starting motor. These units are directly connected to the crank shaft, thus doing away with cumbersome flywheel gears, cranks, pedals, etc. To start the motor it is sufficient

to press a button within easy reach of the driver's hand. The electric controls have been centralized on an ebonite switch-board. The carbureter is of a new and improved design, with variable heading device, which gives the motor a maximum engine efficiency under all conditions. Louis Renault, who was a pioneer in the adoption of the three-quarter elliptic spring, again took the lead in using extra long and absolutely flat springs.

A new type on display is known as the 25 horsepower "Sportif," a light, fast chassis for three and four seated summer bodies. This car has all the refinements of the larger models, and owing to its special construction and exceedingly light weight is said to obtain easily a speed of more than 68 miles an hour. The body exhibited on this chassis was a novel three seater painted dead white, with bright red wheels and upholstery.

A 50 horsepower six-cylinder chassis was mounted with an original seven passenger touring body by Letourneur & Marchand, which was finished with a special inlaid mahogany cowl and side rail. A 30 horsepower four-cylinder limousine by Kellner was an example of a conservative town and suburban car.

An 18 horsepower drop frame Kellner brougham was painted black, with dark green basket work, and trimmed with a delicate shade of French gray. One of the 45 horsepower four-cylinder models was exhibited with a typical Van den Plas torpedo body, finished in light gray. It is an exceptionally roomy and comfortable car for long distance touring. The exhibit also included a 50 horsepower six-cylinder limousine by Demarest & Co.

At the De Dion Bouton exhibit there was a new type shown called the "Aquatic" by the designers and builders, the Holbrook Company. One is a touring model whose exterior form carries out the hull lines of a motor boat. It has a mahogany deck all around, with a cowl of the same wood, projecting from which are two hand hammered copper ventilators. There are only two doors, the front seats being reached by a passageway left between them. The other model was a limousine type called a "Cabintype Aquatic."

FORD HOLDS ITS OWN SHOW

Following its usual custom, the Ford Motor Co. did not exhibit at the Automobile Show, but arranged special show week displays at its salesroom at 1723 Broadway and at the assembling plant at Jackson avenue and Honeywell street, Long Island City.

Gaston Plantiff, New York manager of the company, featured the new closed models, the Sedan, and the coupelet. These new bodies are mounted on the standard model T chassis. The other models include the familiar runabout, the touring car and the town car.

The Ford Motor Co. reports that in the four months ended November 30 there were 74,906 Ford cars sold and delivered. This demonstrates that the Ford schedule of 300,000 cars for the year is being maintained.

GROWTH OF AUTOMOBILE INDUSTRY

An Increase of 680,000 Cars, Fees From Which Amount to \$12,000,000

Fifteen years ago when the first exhibition of motor cars was held in the old Madison Square Garden, there were fewer than 100 automobiles in the country. Last year, according to official figures furnished by Francis M. Hugo, secretary of state of New York, 1,808,441 cars were registered during 1914 from which fees were collected amounting to over \$11,925,295. Last year, despite unsettled business conditions, was the greatest in the history of the industry, as there was an increase of registrations of something like 680,000 cars.

The gain per cent. over the 1913 count, while slightly less

in the leading states—notably New York, Massachusetts, where the increase falls from 28 per cent. to 26 per cent., and from 27 per cent. to 23 per cent., respectively—is emphasized by the significant fact that last year seven states compared with one in 1913 exceeds the hundred thousand mark, and fourteen against eight commonwealths passed the fifty thousand limit, every state reporting an increase from 400 to 40,000 cars.

Secretary of State Hugo explained that during comparatively the same period motorists have contributed directly in the form of registration and license fees the sum of \$31,331,704.10, expressly set aside in most states for the maintenance and repair of the improved highways. During 1914 the amount of fees reached \$11,721,649, compared with \$7,797,440 gathered in 1913.

The total number of motor vehicles registered during the past year, up to December 4, together with the fees collected therefrom, are as follows:

State	Cars	Registration Fees
New York	168,039	\$1,527,396
Illinois	132,199	645,000
California	122,625	1,338,424
Ohio	122,071	605,473
Pennsylvania	112,000	1,184,657
Iowa	100,250	865,767
Massachusetts	77,246	925,964
*Texas (est.)	77,000
Michigan	76,325	275,000
Indiana	66,500	427,039
New Jersey	59,637	808,770
Missouri	54,537	235,418
Wisconsin	53,161	265,805
Nebraska	51,242	102,484
Kansas	50,107	250,535
Washington	29,650	59,300
Connecticut	29,317	406,750
Minnesota	23,000	34,500
South Dakota	21,365	97,000
Maryland	21,026	266,932
Georgia	20,905	104,525
District of Columbia (fiscal year)	5,639	22,556
Colorado	17,851	66,661
North Dakota	17,349	52,047
Oregon	16,347	77,558
Maine	16,028	191,000
North Carolina (since July 1)	14,719	70,000
†South Carolina	14,000
Virginia	13,984	106,349
Rhode Island	13,058	151,224
Oklahoma	13,000	13,000
Kentucky	11,750	65,000
New Hampshire	10,596	184,120
Montana	10,215	27,697
Vermont	8,254	154,344
West Virginia (since July 1)	8,215	65,000
Alabama	8,048	113,210
Arkansas	5,636	56,350
Tennessee	5,470	10,940
Arizona (estimated)	5,000
Idaho (estimated)	3,400
Florida	3,368	6,736
New Mexico	3,090	19,967
Delaware	3,050	36,000
Utah	2,203	4,500
Mississippi (estimated)	1,800
Nevada	1,550	4,241
Totals	1,808,441	\$11,925,245

*County system, number estimated by Dallas Chamber of Commerce.

†County system; number estimated.

PLENTY FOR SALE

Crushed among the strap-hangers who filled a suburban car to the bursting point, a timid man gasped to his neighbor:

"Please give me a little space."

"Don't apply to me," was the answer. "Read that advertising card."

The timid man glanced in the direction indicated and read this announcement: "For space in this car, apply to Stringem's Advertising Agency."

AUTOMOBILE BODIES

Metal Bodies Preferred for the Production of Large Quantities—Also Less Expensive to Finish

By H. Jay Hayes*

Automobile bodies cover a multitude of sins. The method of manufacture and materials used have changed considerably, coming gradually to the use of metal. At present, all-metal bodies are being manufactured successfully, the metal being enameled and finished ready to assemble.

Up to 1899, nothing but wood entered into the major portion of body construction. Letters patent were granted in 1899 for an all-metal body. This body construction was used on an electric automobile and proved very satisfactory. Another body was made for a steam runabout and exhibited at the Washington Park Automobile Show, Chicago, in 1899. The body was very rigid, being made of a three-sided integral base frame constructed of angle iron extending from the front around the rear. The base frame supported all the mechanism, this being prior to the use of chassis frames. The upper portion was a skeleton frame with sheet steel panels lined with asbestos at the sides and rear to act as insulation, etc. The finish was enamel, baked on at a high temperature. This body was practically indestructible and very desirable in the days when steam was used as motive power. One of these bodies was sold to a machinist in Warren, O., to be used on a car he expected to build but never completed. The body was stored in the basement of his shop for 12 years, after which he wrote the manufacturer of the body with regard to selling it. The body was shipped uncrated and arrived in good shape, the enamel being in especially good condition. I mention this to show that if metal is properly treated before painting rust will not affect it. This body is still in excellent condition, having been enameled 15 years ago. There is no question that sheet steel rusts more quickly now than formerly, because of the increased use of carbon and manganese to obtain a smooth surface for finishing.

Metal bodies were more expensive to build in the small quantities used about 1900, and did not appeal to buyers for several reasons, all of which have been eliminated. Later, when gasoline engines came into use, composite bodies with wood framework, covered with sheet aluminum or steel, were developed, the aluminum type predominating in high-priced cars. In some cases cast aluminum was used instead of sheet aluminum. In fact, one manufacturer of very high-grade cars still uses cast aluminum panels which, by the way, are prohibitive for medium-priced cars from the standpoint of cost.

Composite bodies have an advantage not possessed by wood bodies. High grade lumber necessary for body panels has become scarce. This fact, together with the tendency to check or split on account of extremes of heat and cold, made a very serious situation, especially in large production. Many a manufacturer has spent several days in finishing and varnishing wooden bodies in rooms of high temperature, only to see panels split or check upon being exposed to the cold when loading on freight cars for shipment.

Sheet-metal bodies do not require one-third the paint a wooden body does to obtain the same finish, and the cost of painting is much less. Fewer coats are necessary on metal on account of a filler not being required as on wood. Some body manu-

facturers are enameling the sheet metal before applying it to the body, baking the enamel at a high temperature, making a very durable and satisfactory finish for medium-priced cars.

The fight for supremacy among the manufacturers of automobiles has imposed upon the manufacturers of automobile body sheets a most perplexing problem. Naturally methodical and conservative, the steel manufacturers have been spurred on to a pace that fairly makes them dizzy. No one will deny that the requirements of automobile body sheets are vastly different from and more exacting than the requirements of any other grade of sheet metal. The steel sheets now being made for the automobile industry are the finest sheets in every way that have ever been manufactured, either in the United States or abroad. The steel employed is selected with the greatest care, after being made from materials specially selected for the purpose. It is essential that the chemical composition and the physical structure be such as to permit of developing the high finish necessary, providing at the same time ductility, strength and durability. The carbon content should not exceed 10 per cent. to provide ductility, and the manganese content must not exceed .40 per cent. to prevent deterioration. During the process of manufacture in each department it is necessary to exercise much skill and employ extra care to prevent the development of irregularities which may later on cause the stock to become unsuitable for the purpose intended. The precautions take the form of additional labor and result in materially decreasing the output. The sheets are subjected to a very accurate heat treatment to establish uniform temper and to relieve any internal strain that may have developed during the course of manufacture.

The perfect automobile body sheet must be "hard" and "soft" at the same time. It must possess high tensile strength and great ductility. Only a mirror-like surface is accepted and oftentimes that surface is subjected to microscopic inspection. Five years ago a full-pickled cold-rolled sheet answered all purposes. Today special heats, analysis, carefully supervised bar treatment, hot-rolling, cold-rolling and annealing must be given to meet each individual requirement of a discriminating customer. Body, fender and radiator sheets no longer belong to the same family. They may be of the same genus and look alike, but the basic ingredients and qualities are radically different. Steel to be used for pressing or stamping must be soft enough for drawing without cracking or straining the metal too severely. Usually the stampings for tonneau backs are made in three pieces, as also for the shroud or cowl, and then joined together by spot-welding or acetylene welding and afterward soldered and smoothed off to make a good joint. Invariably it is necessary to bump or hammer these parts, which naturally hardens the metal, causing crystallization later. While this has apparently been satisfactory, a great deal of care is necessary in preparing the metal for painting. Painters do not like anything that looks like solder. Occasionally trouble arises after the body has been used a short time, on account of opening at the joint, or the paint coming off, attributable possibly to imperfect cleaning of the metal. Some wonderful press operations are now being conducted, eliminating practically all the above difficulties and crystallization, etc. One-piece stampings of back seats and cowls are now being made very satisfactorily in one operation. This allows the metal to remain ductile with little, if any, tendency to crystallize. The one-piece stampings make

*President, Hayes Manufacturing Co. Paper presented at the annual meeting of the Society of Automobile Engineers, January 6 and 7, 1915.

a complete body shell containing practically four pieces, as follows:

Tonneau.

Cowl.

Two side panels.

Against eight pieces with the other construction.

Again, less wood frame-work is necessary, as the metal has more rigidity and less weight. The metal is also less expensive to finish.

The gages of steel sheets are usually 18, 20 and 22, according to the strength required. The metal must have clean surfaces before painting. Sand blasting is used to eradicate all irregularities. If metal is to be exposed to the elements for any length of time, it is better to coat it with a primer of red lead, which, being a double oxide of lead, is an excellent anti-corrosive primer.

Metal garnish rails have replaced wooden ones. In most cases the sheet forming the door panel extends over the door opening, eliminating the need of molding and overcoming the former difficulty of paint cracking around the molding.

White ash or maple is usually used for sills, posts, etc. When properly designed, bodies can be made very light and very strong with under-frames strong enough to support them. The lumber is usually dried in the air for three to six months and then exposed to a current of hot air in dry kilns for six to ten days, the temperature depending on the kind and the dimensions of the stock.

Gradually metal is taking the place of wood in body building, as in railroad car construction. Some of the largest automobile manufacturers are using all-metal bodies. It will be only a short time before the majority of medium-priced cars will be equipped with all-metal bodies finished with enamel, baked on at a high temperature, saving time and producing a much more durable finish.

SIMPLICITY LEADS IN NEW MODELS

Parts Reduced, Straps and Superfluous Rods and Wires Disappear

The trend of the automobile industry is toward simplicity, says E. W. Headington, of the Haynes Automobile Co.

It is a well known axiom that a simple machine will outlive a complicated one, and this has been the keynote of the 1915 season automobile design. The number of parts has been greatly reduced from that of other years, with the consequent result that the points of wear have been correspondingly reduced.

It is a revelation to inspect the motors in the new cars. Where there was once a maze of wires and cluttered up accessories there is now a neatly arranged system of conduit enclosed wiring and compact auxiliary units. Everything is clean cut. The streamline body prevails mainly on account of its simplicity of lines. It is at once pleasing and serviceable. The one man type top predominates and carries the idea of simplicity a step further in fastening securely to the top of the windshield without the aid of straps and rods. Even the straps have been eliminated from the tire carrier, and a simple means of locking the tire substituted.

The idea that a great amount of weight is necessary for easy riding has given way to the fact that it is more a question of the proper distribution of the weight to the front and rear axles that affects the riding qualities.

A glance at the chassis shows a greater tendency toward simple construction. The greatest change noticeable here is the absence of the torque bar and radius rods. The torque of the rear axle is taken through the rear springs. Using the springs for flexible torque bars has long been a practice abroad, but it is only within the last year that American designers have realized its possibilities.

The running boards are kept clear, and the storage battery

is either under the front seat or swung in the chassis. A great step toward reducing the number of accessory units on the car is the replacing of the magneto with the generator storage battery system of ignition. The generator and storage battery are already necessary parts for electric cranking and lighting. The change of this new type of ignition system is very marked, and has eliminated the magneto in 40 per cent. of the models being exhibited this year.

EXPORT OVER \$40,000,000 CARS

Sales of American Cars Abroad Smash All Records Despite War—Motor Trucks Gain Make Up for Loss on Pleasure Cars

Exports of automobiles from the United States in the fiscal year ended June 30, 1914, were the largest on record. Their total, including shipments to Alaska, Hawaii and Porto Rico, amounted to \$40,136,565, against \$99,325,000 in 1913, the former high-record year. The year's total included 30,136 complete cars, valued at \$27,797,642; automobile tires, \$4,159,454; automobile engines, \$1,391,893, and miscellaneous parts not specified, \$6,787,575.

With the sole exception of 1908, every year during the past decade has shown an advance in value of American automobiles sold to foreign countries. In the fiscal year 1908, according to the Bureau of Foreign and Domestic Commerce, Department of Commerce, the value of automobiles exported was \$1,895,605; in 1909, \$5,387,021; and in 1914, exclusive of parts and shipments to our own noncontiguous territories, \$26,574,574, having quintupled in five years and increased thirteen fold in a decade.

Europe bought nearly one-half of our entire sales of automobiles to foreign countries last year, although some shipments thither are for reshipment to other parts of the world. To the United Kingdom the exports amounted to 7,222 cars, valued at \$5,853,127; to Germany, 1,435, valued at \$1,059,249; to France, 1,429, valued at \$924,130; and to other countries of Europe, 3,271, valued at \$2,580,428. Canada and Australia are also important markets, the former having taken 4,624 cars, valued at \$5,919,776; and the latter, including other British Oceania, 4,244 cars, valued at \$3,695,595. To South America as a whole we sold last year 1,985 automobiles, valued at \$1,939,212; and to Mexico 167, valued at \$256,675.

Since August 1, owing to the European war, there has been a great falling off in the sale of pleasure cars, but since that time the loss has been more than made up by the sale of motor trucks. Owing to the fact that these sales are in a measure secret, the exact amount of these truck sales will not be available until later in the year.

Roughly, it is understood that over 3,000 trucks, valued at over \$6,000,000, have been sold, and many more orders will probably come later.

UNITED STATES TIRE CO. CONCENTRATES ITS WORK

The United States Tire Co. was formed in 1911 to market four of the best known brands of tires, namely: Morgan & Wright, made at Detroit; the Hartford, made at Hartford, Connecticut; the G. & J., made in Indianapolis, and the Continental, made by the Revere Rubber Co., Providence, R. I. For about a year these tires were sold under their individual names. Then the four brands were eliminated, or at least subordinated, and all the tires were sold under the general brands, United States Tire Co. Now, in order to manufacture with greater economy and better facilities for specialization, the company intends to concentrate the manufacture of automobile tires in two of its plants, namely, those at Hartford and Detroit, while all its bicycle and motorcycle tire will be made at the Indianapolis plant and the solid tires, for motor trucks, carriages and other vehicles, will be manufactured in the Revere plant at Providence.

WOOD AND WIRE WHEELS

A Discussion of the Relative Merits of Each By Their Manufacturers—Tests and Their Results

WOOD WHEELS VS. WIRE WHEELS

By R. B. Mudge*

Necessity fosters new ideas, and when a thing in its present form is unsatisfactory, a remedy is sought either through improvement of the original or through some radical departure from the principles of the existing type. The proposed remedy, particularly if of the latter class, must necessarily be largely in the nature of an experiment, and may or may not be successful. Such was the situation with the automobile wheel abroad. The foreign wood wheel might not have been entirely satisfactory. The wood material available was inferior in quality and not entirely suited to the purpose. Knowledge of the proper way to treat this wood to preserve its full natural strength was lacking. The methods of assembling the parts to get the best possible results were perhaps not as widely understood as on this side of the Atlantic. Little improvement was possible since the greatest weakness lay in the character of the material itself, and, accordingly, experimentation along new lines followed, and the wire wheel appeared. Its success is questionable. Several tests were made in England by the wire wheel people that seemed to indicate superior strength in the wire wheel, as compared with those made of English oak, and there is no reason to doubt that the tests were reliable. Again, tests made in London to observe comparative tire wear resulted favorably for the wire wheel, although these results can scarcely be accepted as conclusive, since the runs were made for the most part, if not wholly, over city streets, where the wire wheel would be most apt to compare favorably. On the other hand, many inherent weaknesses were revealed to offset whatever advantages were apparent, and the users of this type of wheel are still in the minority. A little later it was introduced in this country.

Conditions Different in America

Here conditions were different. The wood artillery wheel in general use here was rendering satisfactory service, and there was little inducement to take up the innovation of doubtful performance even under road conditions far more favorable than those to be encountered in America. Thus the burden of proof remained with the wire wheel advocates, and up to the present time the same situation prevails. In view of this fact, the supporters of the wood wheel have confined themselves largely to consideration of the various claims put forth for the new type, some of these claims being extravagant in the extreme.

Tire Life

One point which has been brought up many times, and one which is of prime importance, is that of the relation of the life of a tire to the type of wheel on which it is used. Many unqualified assertions have been made as to the great saving due to use of wire wheels. It is pointed out that being lighter, the total unsprung weight of the car is less; that having less peripheral weight, the flywheel action is reduced; that possessing greater resiliency, there is more "give" in sudden starting and

stopping; that the so-called "suspension principle" gives greater distribution of load.

Comparisons made between wood and wire wheels, designed for the same car, and equipped with the same type of rims in each case, have demonstrated that there is little or no difference in weight between the two. The wood wheel is often placed in a somewhat disadvantageous light by taking its weight equipped with one of the heavier types of demountable rims, as against the wire wheel equipped with only a simple light clincher rim. This is likewise the condition under which the peripheral weight is shown greater on the wood wheel.

Wood Wheel More Resilient

It seems to be a popular idea that the wood wheel is a rigid, unyielding structure, while the wire is springy and resilient to a high degree. The real state of affairs is somewhat different, as has been proven beyond a doubt in a number of tests, made in outside laboratories by disinterested parties. The wooden unit, with its springy arches of tough, seasoned hickory, and its spokes united in a peculiar interdependent bond at the mitre, does not take up the load at the one point of contact only, but distributes it over the entire lower half of the wheel in varying proportions. In actual test, the load sustained by the wheel averages about $2\frac{1}{4}$ times the strength of a single spoke, or in other words, each spoke in turn assumes less than 45 per cent. of the total load.

The wire wheel, being composed of tension members, takes all the load in the upper half of the wheel, and the lower half offers no resistance against flattening of the rim, except the stiffness of the rim itself. The wire wheel people argue that their product has greater circularity than the wood wheel because of 60 or 70 points of support along the rim instead of 10 or 12. They say the wood wheel tends to become a ten or twelve-sided polygon, while the wire wheel has so many members bearing on the rim as to maintain a perfect circle. Yet none of the members in the lower half of the wheel, where the blow is struck, can stand any appreciable compression, and they are therefore useless as far as preventing the rim from becoming crushed down entirely is concerned.

Tests Favorable to Wood Wheel

Several tests were made at the University of Michigan, which bear out this point well, and likewise demonstrate the true state of affairs as to ability to give under a shock and power of recovery after loading has been released. The wheels tested were for the same car, mounted on the same hubs, and both equipped with clincher rims. The wheels were placed between two heavy compression heads and crushed. The wood wheel flattened slightly on the rim after 8,000 or 10,000 pounds had been applied, but otherwise showed no distress until the breaking point was reached, when it started to go down and would take no higher loading. This was at 17,000 pounds. The wire wheel behaved in a peculiar manner. The spokes bent almost immediately upon application of the load, and at 5,000 or 6,000 pounds the wheel was no longer in a condition to be of any use. Further load was sustained by the rim alone, which steadily flattened out across two-thirds the diameter of the wheel. At 8,000 pounds the rim steadily became crippled under continued pressure, without increase of load until flattened as above mentioned. Then the wheel took further loading up to 13,500

*Chief engineer, Hayes Wheel Co. Paper presented at the annual meeting of the Society of Automobile Engineers, New York, January 6 and 7, 1915.

pounds. After release, the wood recovered to nearly the original circle. No recovery at all was apparent in the wire wheel.

Considering the alleged springiness of the wire wheel from another standpoint, let us refer to another test made at the same time. This experiment, which Mr. Menefee, engineer in charge of the laboratory, termed the rim-dishing tests, was designed to approximate as nearly as possible the conditions under which the wheel receives the shock in service when skidding against a curb. The wheels of the same type as in the foregoing test were mounted on their axles in each case, with the bearings in place, and the axles clamped securely, leaving the rim free all around. Then the load was applied at one point on the rim. The test was started at an initial loading of 100 pounds, and increased by increments of 200 pounds, with the deflection recorded after each additional loading. After every other reading the load was run down to the initial point and the amount of permanent set measured and recorded.

Load deflection curves were plotted and results obtained as shown below:

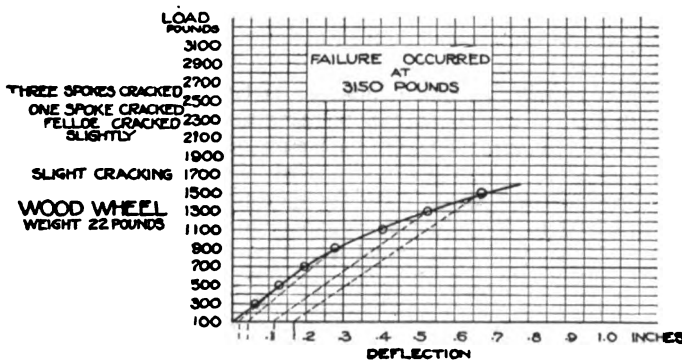
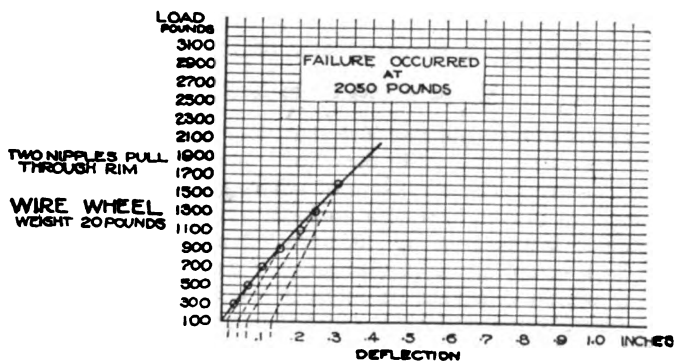

One striking point to be noticed is that while the deflections of the wood wheel were far greater than those of the wire wheel, yet the permanent set was found to exceed that of the wire wheel but little, showing that the large deflection under load was due not to weakness, but rather to elasticity. To quote Mr. Menefee in that part of his report wherein he refers to the wood wheels: "The deflection curves are very nearly identical for the three wheels, and are very flat. This might seem unfavorable until it is seen that there is a comparatively small set, which proves that the deflection is one almost entirely of elastic nature." To further bear this out, the wood wheel sustained a considerably higher load than that at which failure occurred with the more rigid wire wheel. This is of vital importance, when it is considered that greater strength is shown where the greatest strength in service is required, namely lateral strains.

Greatest Strength Required Against Lateral Strains

A wheel has many times the strength of resistance against loading, as compared with skidding, curb impact, and strains of a like nature, and it is under the latter conditions that failure will occur, if at all. In speaking of the resistance against direct loading, let us mention, briefly, the surprising developments in

a test made at the university along this line. A wheel and axle assembly was set up and the load applied exactly as though under a car. The load was run up to 24,000 pounds, and at that point the axle gave way in a sharp, clean break, with no flaws in the steel apparent. The wheel was slightly flattened at the rim and one spoke bent a little, but was otherwise intact. The wire wheel, subjected to an equal loading, became a misshapen wreck.

In every test made the wood wheel excelled in elasticity, in both dishing and compression; showed greater strength in a direction in which greater strength is vital; and displayed greater resiliency and recovery under direct pressure, a point in which wire wheel advocates have claimed superiority and on which they have largely based their claims to easier riding qualities and longer tire life.

Tests, by Automobile Club of America

The road tests of the Pennsylvania "Vacuum Cup" tires, recently conducted by the testing laboratory of the Automobile Club of America, furnishes some interesting data having a definite bearing on the question of tire life. In this test, similar cars were driven at the same average speeds, over the same routes, which were changed daily to include both good and poor country roads and city streets. To eliminate the personal element, the drivers changed cars daily, and after half the probable mileage had been covered the wheels were interchanged on the chassis. Obviously, the conditions were as nearly the same throughout as could ever be possible. The tires on the wood wheels averaged 8,076 miles as against 6,470 for the wire. The maximum mileage for any tire was 10,164, obtained on a wood wheel. The maximum mileage on a wire wheel was 9,220 miles. The point of longer tire life on wire wheels, with the subsequent question of economy, would appear to be an exploded theory.

Wire Wheel Faults

There are several objections to the use of wire wheels, aside from the question of strength, riding qualities and effect on tires. The initial cost is high as compared with that of the wood wheel. The spokes are frequently snapped through contact with curbs, car tracks, or in deep ruts on country roads. This throws the wheel out of balance, and out of true, and prompt replacement of the broken members is essential. Thus the question of repairs becomes burdensome and an annoyance as well. Again, the problem of keeping a wire wheel clean is one that appeals but little to anyone with experience in this connection. One serious feature is that under severe usage the spikes tend to loosen up, particularly if one or two are broken, so as to throw uneven tension on the rest. This causes sufficient play around the spoke seat to allow moisture to seep up through inside the rim, to the detriment of the tires.

Wood Wheel in Universal Use Today

Everything considered, the wire wheel certainly has not met with marked success in America. The action of car manufacturers who, after trying wire wheels, have gone back to the wood wheel is significant. Further, the wire wheel has fared but little better abroad, where the conditions for its adoption are apparently much more favorable than in this country. An article published during the summer (Motor, July, 1914) gives some interesting information on the present-day use of automobile wheels, classifying them according to the percentage of the total number used. The figures may be tabulated as follows:

	Wood Wheel Per cent.	Wire Wheel Per cent.	Steel Wheel Per cent.
British	44.7	36.9	18.4
German	76.2	8.9	15.2
French	78.2	16.7	5.1
American	98.2	1.8	0.0

The wire wheel has yet to prove its worth, and car owner and manufacturer alike show little tendency to forsake their allegiance to the truly reliable wood wheel.

WIRE WHEELS VS. WOOD WHEELS

By George W. Houk*

A great many articles have appeared during the past three years on wire and wood wheels. In two or three instances tests have been conducted with a view to ascertaining the relative strength of as well as relative tire economy with the respective wheels.

In one test of wire, wood and steel wheels, 34 in. steel and 36 in. wood and wire wheels were used, giving advantage to the steel wheel. In making comparisons I have selected equal sized wheels, with equal width rims. None of the wheels was specially selected. The wood wheels were examples of those used by two leading American companies, one a manufacturer of a \$4,000 and the other of a \$500 car.

In a paper presented to the society in June, 1913, I described the method of testing by impact. I have since learned that the results from this method are not as easy to determine as those of a steady pull applied to the rim of the wheel with the hub anchored, or with the pull applied to the hub. Fig. 1 shows the machine used in the tests, the leverage of beam being 20 to 1.

Referring to Fig. 2, it is noted that in the case of the 34 x 4 1/2 No. 6, 72-spoke Q. D. clincher wire wheel, with the load applied at the rim, starting at 500 pounds, the deflection was .020 in., and applying the load in 500-pound increments, at 4,000 pounds, the deflection was .200 in., or about 13/64 in. The permanent set was .035 in. At 8,000 pounds load the permanent set was

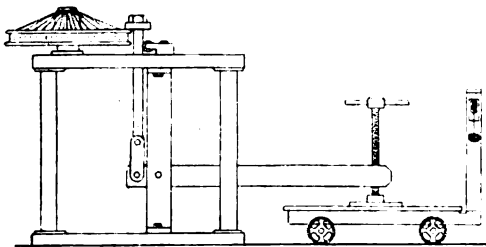

Fig. 1

.085 in., or less than 3/32 in. At 9,000 pounds load four spokes snapped, the permanent set being .177 in., or less than 3/16 in. No other damage occurred in any way.

In selecting a wood or artillery-type wheel for comparative test, we used what is considered a very strong pleasure car wood wheel, supported by a pressed steel brake-drum of 16 in. diameter and 1/4 in. thickness, the dished spokes being 2 1/4 in. thick from the hub to the brake-drum outside diameter, and 2 in. at the felloe. The weight of this wheel, including brake-drum and demountable rim, was 90 pounds; deducting 23 pounds, the weight of the brake-drum, leaves 67 pounds actual weight of wheel, as against 42 pounds in the case of the wire wheel; the wood being 67.5 per cent. heavier.

At 4,000 pounds load the permanent set of the wood wheel was .123 in.; at 5,000 pounds, .203 in. Between 8,500 and 9,000 pounds the spokes commenced to loosen and pull away from the hub. The permanent set was .863 in., or almost 7/8 in.

The other wood wheel was a 34 x 4 1/2 in. with demountable rim, with 2 in. dished spokes and heavy hub flanges, and weighed 65 pounds. It was not equipped with a brake-drum, it being a front wheel. In the case of this wheel the permanent set was .183 in. at 2,500 pounds; .625 in. at 4,000 pounds; 1.413 in. at 5,000 pounds. After 5,000 pounds had been reached the spokes began to loosen at the hub. At 5,600 pounds one of the spokes cracked near the hub, the permanent set being 2.366 in.

The permanent set of the No. 5, 34 x 4 plain clincher wire wheel was .029 at 4,000 pounds load; .057 in. at 6,000 pounds;

.132 in. at 8,000 pounds. At 8,200 pounds a deflection of .554 in. occurred, with one spoke broken. The permanent set was .216 in., or about 7/32 in.

The 34 x 4 wood wheel, with 1 3/8 in. spokes, had at 1,200 pounds a permanent set of .107 in.; at 1,800 pounds, .352 in.; at 2,150 pounds, 2.257 in. No further load could be applied, the spokes having pulled away from the hub.

In the form of test showed in Fig. 4, the wheel was supported

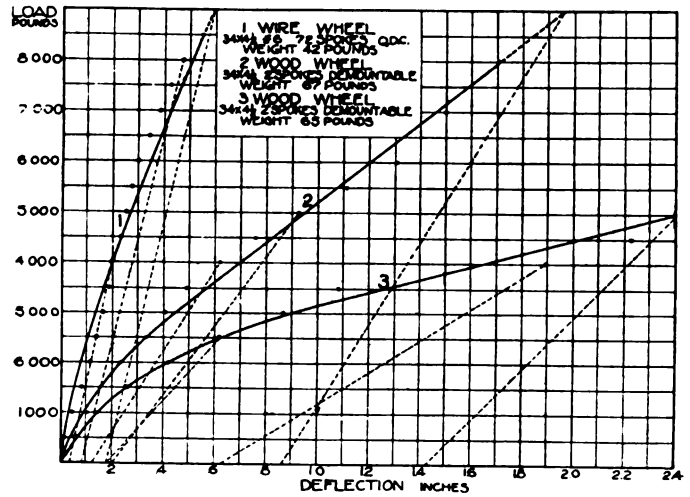

Fig. 2

at the rim and the load applied at the hub, thereby distributing the load on all the spokes equally. The 30 x 3 plain clincher No. 3 wire wheel, with 48 spokes and weighing 16 pounds, deflected .163 in. at 4,000 pounds load, the permanent set being .028 in. At 7,500 pounds the deflection was .336 in., the permanent set being 7/64 in. At 10,500 pounds the deflection was .455 in., and the permanent set .127 in., about 1/8 in.

The results of the same test, with a 30 x 3 plain clincher 1 1/4 in. spoke wood wheel, weighing 20 pounds, are given. At 2,000 pounds there was a deflection of .251 in. When the load was released the permanent set was .060 in. At 3,000 pounds the deflection was .663 in.; with the load released a distortion of

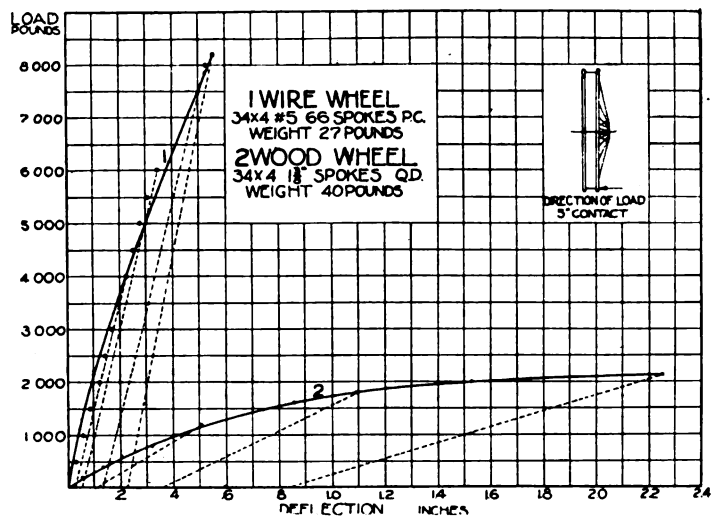

Fig. 3

.205 in. remained. The load was then increased until 3,600 pounds was applied, when the wheel was declared unfit for service. The pressure was continued to 4,600 pounds, when the wheel collapsed.

In Fig. 5 the vertical-load style of test is indicated, the load being applied to the hub, and the rim supported with a 6 in. arc of contact for receiving the load. The load on a 34 x 4 in. No. 4 66-spoke Q. D. clincher wire wheel was increased 1,000 pounds

*George W. Houk Co. Paper presented at the annual meeting of the Society of Automobile Engineers, New York, January 6 and 7, 1915.

at a time and the deflection noted, up to 15,000 pounds, at which the permanent set was .020 in. All spokes were tight and no injury was observed in any part of the wheel.

The spokes used in the wire wheels were of .175 in. wire, upset from .175 in., tapering to .193 in. under the head, with thread rolled to .192 in. diameter for nipple, the spokes being swaged to .156 in. diameter to within about 1½ in. from each end. All spokes were equally spaced at the rim, as well as the hub, this method of spoking being a radical departure from the foreign methods. The spokes are placed at an angle of 40 deg.

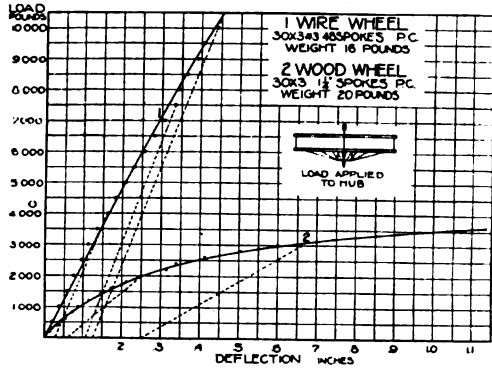

Fig. 4

to a tangent at their point of contact with the hub. The old method of building a wire wheel, allowing the hub to float during the tightening of spokes, and having the truer locate the tread, as well as its trueness, left some of the spokes carrying most of the load, causing spoke breakage. By fixing the position of the hub before the spokes are tightened, and using a wrench turned by a flexible shaft driven by weight-controlled friction to tighten the spokes, a wheel is produced with equal spoke tension, leaving but a slight inaccuracy to be overcome by the truer. The seating of nipples at the rim requires very careful and accurate punching to give them a full seat.

The means for detaching wire wheels call for much careful study. They may be classified as "positive locking" and "self-

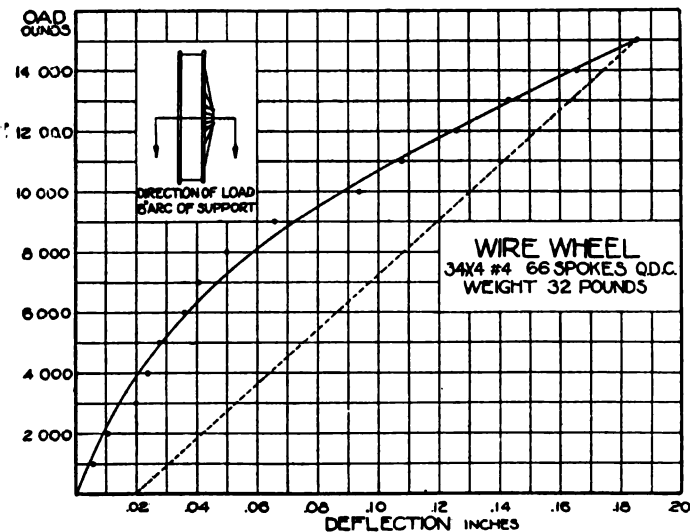

Fig. 5

locking." In the former the locking nut remains where the wrench leaves it. There is some danger of the operator not pulling the locking nut home and seating the shell to the inner hub. Relatively few miles of travel under this condition will cause damage to both shell and hub. The self-locking nut, if left loose, will find its seat as soon as the wheel has traveled a mile or so. This is due to the eccentric motion of the outer hub in relation to the inner hub; the frictional surface of the

threaded portion of the locking nut offering more resistance than the contact surfaces of the smooth taper permits it to creep, and the nut will travel in the direction it should. A simple spring-latch, with the point beveled in the direction of its travel, with a notched ring inside the hub, will insure all lost motion being taken up by the automatic self-locking operation permanently until the wrench is applied.

In making a comparison of wire and wood wheels with regard to wear of tires, I have no real tests to support my belief, but the experience gained from three years' contact with consumers who have tried both types of wheel, justifies a claim of superiority in favor of the wire wheel as high as 30 per cent. The radiating surface offered by the wire spokes, and the small weight at the periphery of the wheel, are considered factors to this end.

The question "What harm is caused by the rusting of spokes?" is often asked. I know of no complaint on account of rust when the wheels have been carefully cleaned and treated with a rust-proofing compound before enameling. Nickel plated wheels rust easily, resulting in spoke breakage.

It is claimed that more labor is required to wash a wire than a wood wheel. This is not the case when a properly designed brush fitted with stiff bristles is used.

Another advantage wire wheels have is that when a 60 in. tread is required, by changing horizontally the relation of the rim to the hub, the same axles and hub mountings can be used as with 56 in. tread.

FEDERAL COURT HOLDS STATE TIRE CORE PATENT INVALID

A decision of great importance to manufacturers of detachable tires, and tire core manufacturers, has just been received from Judge Dodge, of the United State District Court for the District of Massachusetts, by Spear, Middleton, Donaldson & Spear, Washington, D. C., attorneys for the Hood Rubber Co., Watertown, Mass., holding invalid all of the claims of United States patent 865,064, granted September 3, 1907, to Will C. State, and now owned by the Goodyear Tire and Rubber Co., of Akron, O.

It was asserted by the plaintiff in this suit that the State patent covered all types of cores, used in the manufacture of detachable tires, having substantially non-extensible edges and comprising a plurality of independent sections held in ring formation by one or more rings overlapping the inner portions of the sections.

The court found that, prior to the invention of this core by State, substantially the same construction had been in commercial use at the plant of the Goodrich Rubber Co., of Akron, O., and had also been in general use by the Fisk Rubber Co., of Chicopee Falls, Mass., in the manufacture of detachable tires having substantially non-extensible edges.

The suit just decided was filed December 5, 1910. Another suit on the same patent brought by the Goodyear Tire and Rubber Co. against the Ajax-Grieb Company is now pending in the United States District Court for the District of New Jersey.

WALTER C. WHITE DESCRIBES TRUE STREAMLINE BODY

Declares Term as Applied to Automobiles Has Been Much Abused

The term streamline has been much abused. In its application to the design of an automobile body it threatened to become almost meaningless. Because of the multiplicity of designs which have taken the misnomer "streamline" the public impression of such a body today is far from the original idea as conceived in Europe a few years ago.

Some manufacturers, says Walter C. White, vice-president of

the White Company, would have the public believe that the streamline principle is accomplished by a slight change in the dash—by abolishing that section of the dash which, in old style cars, rises above and extends beyond the sides of the bonnet. This, however, is far from a realization of the streamline principle, for the reason that a true streamline design requires more than the taking of a few kinks out of the dash.

Another fallacy is the belief that a streamline design is obtained by straight lines and smooth surfaces regardless of the angle of projection against the wind. The true streamline, on the other hand, is the natural course or stream of air current sweeping the sides of a moving object, whether that object be an automobile, a bird or a bullet. And it naturally follows that the general shape of an object determines the degree to which a streamline design is possible of achievement.

The design which causes the smallest deflection of air currents and which allows a body to move with the least atmospheric disturbance or resistance comes nearest to the streamline principle. Thus every inch of an automobile body must be taken into consideration. Nature proves the principle in certain birds and in fish. There is no fish or fast flying bird whose body or tail is blunt. Their bodies are of streamline form to keep down resistance.

IMPORT DUTIES ON MOTOR VEHICLES

The United Kingdom and Canada Each Take About One-fifth Our Total Exports

The extraordinary development of the American automobile industry is reflected in the rapid growth of the exports of automobiles from the United States, which amounted to nearly \$28,000,000 during the fiscal year 1914, exclusive of parts and accessories. While the above sum constitutes less than 6 per cent. of the value of the automobiles produced in the United States during the last calendar year, it is nearly 45 times as large as the value of the automobiles imported and 13 times as large as the exports of automobiles a decade ago.

The Bureau of Foreign and Domestic Commerce, of the Department of Commerce, has just issued a report showing the rates of import duty on motor vehicles of all kinds and accessories in practically all foreign countries. The rates are given in both foreign currencies and weights and their American equivalents, inclusive of surtaxes and similar items which serve to increase the cost of importation. There is, in addition, a summary table in which the rates are arranged so as to facilitate comparison between various countries.

In considering the foreign tariffs on automobiles in connection with the distribution of the American automobiles exported during the fiscal year 1914, it would seem that the rate of duty is not always the determining factor. Our best two customers for automobiles are the United Kingdom, which admits them free of duty, and Canada, where they are dutiable at 35 per cent. ad valorem, each taking about one-fifth of our total exports. Australia, in spite of its import duty of about \$120 on the body, 5 per cent. on the chassis, and 25 per cent. on the tires, bought American automobiles to the value of more than \$2,600,000, while Argentina, with its comparatively low rate of 12 per cent. ad valorem, took only about \$1,000,000 worth, or about four times as much as was taken by Brazil, where the duty is about 16 per cent. ad valorem. An interesting feature in connection with the importation of automobiles into Australia and New Zealand is the requirement for a detailed list of the prices of the various component parts and accessories as sold for home consumption, such prices being used as a basis for ad valorem duties. This requirement differs from the provision of the Canadian dumping clause, where the statement in regard to the value for home consumption is required for the purpose of preventing or penalizing unfair competition with Canadian producers.

CAR SEATING SHOWS CHANGE FOR BETTER

New Arrangements Add to Comfort, Body Beauty and Makes Conversation Easy

Everybody remembers the time a few years back when an automobile had to be painted red, without top, and its rear portion was much like a box stall with a rear door. No danger of contaminating the family in it by contact with the greasy leather-coated mechanic on the front seat.

Happily its day did not last long. The next one had side doors at the rear but quite forgot the front which for a year or two went without. Just how the requirements of beauty or service could be met by such a combination of doors and no doors is not clear. If the driver in front did not need doors why were there doors in the rear? Or, if the rear needed protection, why not the front? Such questions went unanswered.

Other but less pronounced changes followed, and as the industry widened they became less noticeable. In the main the two-passenger front and three-passenger rear seat held sway. Occasionally two additional seats were fitted, but the general design was all but universal in all family cars. Within the last year or two changes have been creeping in. The recent New York show presented a goodly number of cars with very different seatings.

The speedster with no doors to its two-passenger seat is one of the forms of the last year or two. Flat, low, and racy looking, it will please many who want a business looking vehicle without gewgaws. The three-door body is also not new, but will be seen in greater number this year. But the greatest advance has been in four-passenger bodies. The horse vehicle user stuck to two and four-passenger bodies for family use, and it is evident that the needs of the family have not greatly changed because of the advent of the auto. In the final analysis the "two are company but three a crowd" will prove as true in auto seats as in horse vehicles.

One style to be seen is the chair-seated vehicle, in which portable chairs take the place of seats and can be arranged to suit the passengers or taken out altogether for cleaning or other reasons. Another style is the "corridor" body, in which the rear seats are close to the front and reached through a passage or corridor between the front seats, the front door or doors serving all seats by this arrangement.

Much like this is the body in which one of the front seats drops or folds out of the way, making an ample passage to the rear. The gain in conversational ease with such a close seating is well worth considering, particularly when the owner drives. It also adds to the comfort of the rear passengers by bringing them more between the wheels, where the riding motion is easier than over or behind the rear axle. Still other bodies use revolving chairs like parlor-car seats, that can be swung around as desired.

WHAT IS IT THAT SELLS A CAR?

Essay Contest on What the Essential Features Are That Enter Into Car Selling

Studebaker salesmen all over the United States are writing essays in a competition which is expected to develop hard facts in scientific salesmanship. The contest includes more than 1,000 men with excellent prospects of three times as many entrants before the lists close and the work of the judges is begun. "How to Sell a Studebaker Car" is the subject assigned the essayists.

The event is a sweepstakes, as far as the cash prizes are concerned, with a special division and prize for each of the company's branches and distributing districts. It is, of course, open only to members of the organization. Every state and virtually every trading center is represented with from one to several score of contestants.

The contest is the idea of L. J. Ollier, sales manager of the organization, who explains its purpose as follows:

"Something sells the car. That something is probably a combination of various merits such as its reputation as a veteran manufacturer, the obvious beauty of the cars themselves, their records for durability, the full floating rear axle with which they are all equipped—these, and perhaps 400 others; some of our salesmen maintain there are as many as 472 selling reasons.

"Just what elements really count most in selling a car we do not know; we can only guess. The competition is our effort to find out. It will serve not only to establish definite standards, tested and found successful by hundreds and thousands of salesmen, but may also give us a definite line of approach applicable to the general run of prospective buyers. It should also enable our salesmen to avoid much loss of valuable time—their own time and that of the buyer's."

The essays will be judged by E. R. Benson and James G. Heaslet, vice-presidents, and George E. Willman, advertising manager, of the Studebaker organization, assisted by W. Robbins, of the Wagner Electric Co., and E. A. Walton, of the Burroughs Adding Machine Co. The winning productions will be published in the Studebaker Salesman.

NEW AUTOMOBILE COMPANY

The Mutual Motors Co., with J. I. Handley as president and general manager, just incorporated under the laws of Indiana, will be devoted to the building of motor cars in Jackson, Mich., in a plant which already has been provided and which covers 17 acres, the building proper being a two-story brick, 440 x 900 feet in dimensions. This plant is one of the most extensive and modern in the entire industry.

The Mutual will manufacture for two affiliated concerns, namely, the Marion Motor Co., the general offices of which will remain in Indianapolis, and the Imperial Automobile Co., the general offices and personnel of which will remain undisturbed in Jackson, Mich.

The Mutual Motors Co. is strictly a manufacturing concern and will in no way interest itself in the sales or distributing of either Marion or Imperial cars or any other cars hereafter added to its manufacturing program. Each organization will remain independent and complete within itself, simply engaging the Mutual Motors Co. to take care of the manufacturing end of their business.

HOW THE WAR AFFECTED FRENCH GOODRICH BRANCH

Arthur Lumsden, the general manager of the French and English branches of the B. F. Goodrich Co., of Akron, O., in a recent letter to the home firm gives an account of the effect of the European war on the Paris branch. It is to be noted, parenthetically, that the French branch of the Goodrich factory is a manufacturing one, and hence the tires were admitted in the government subsidy scheme as part of the equipment of subsidized trucks. Otherwise, the arrangement mentioned would not have been made.

"Our men had been paid as usual at noon on the Saturday France started to mobilize her army," said Mr. Lumsden, "and at 4:30 o'clock the notices were posted putting the entire nation on a war basis. As our pay list is made up on Wednesday evening, arrangements were made for the cashier to be at the office on Sunday morning at 5 o'clock, in order that the men who were going to the front could collect their arrears of wages. In this way every man who left our works to go on active service went away fully paid.

"On Monday morning I was curious to see what the conditions would be at the factory. We found we had 80 men who were not eligible for active service. These men included most of those engaged in the band tire department. According to a previous arrangement with the French government, this de-

partment went under military control automatically as soon as war was declared, and we were put under an obligation to produce certain quantities of tires for army trucks.

"Practically our entire stock of tires, both at the factory and at the Paris stores, was requisitioned by the government. These tires were left in our hands, but could not be sold to the public, the army having the right to call for them according to a pre-established tariff, which is practically the price paid by dealers. There was no interruption in the production of band tires for trucks, but practically all we produced were taken up by the army. The strict regulations under which we have existed for a couple of months have been somewhat relaxed of late. We have been able to begin, on a small scale, the production of pneumatic tires and also to offer some of our stock to the public. It is expected that within a few days arrangements will be completed whereby we can export to England, and thereby supplying the European countries not involved in the war."

RUSSIA WANTS AUTOS

U. S. Consul at Batum Reports Favorable Market There for American Cars

According to United States Consul F. Willoughby Smith, stationed at Batum, the time is particularly favorable for the introduction in Russia of automobiles, motor trucks, and motor cycles, as practically all of those in the country have been requisitioned for military purposes.

"Motor trucks are used in the oil fields, mines, on farms, by factories, by the military, for passenger service, and for general traffic on the roads to Persia," the consul reports. "It must be noted that neither dealers nor the public will buy from catalogs, and they are not willing to wait the length of time required to bring a car out from the United States. The few American lightweight cars introduced in the Caucasus have been favorably received. The duty on automobiles is as follows: Motors for four passengers or more, \$113.30; fewer than four passengers, \$72.10; chassis, \$36.05; motor cycles, two wheels, \$10.30; three wheels, \$36.05; four wheels, \$72.10.

KELLY-SPRINGFIELD DIVIDENDS

The Kelly-Springfield Tire Co. has declared quarterly dividends of 1½ per cent. on the 6 per cent. preferred stock of the company and 1¼ per cent. on the 7 per cent. preferred stock—payable January 2 to stockholders of record on December 15; also a dividend of 1½ per cent. on common stock, payable February 1 to stockholders of record on January 15. This is the first dividend declared by the company on its common stock, which two years ago sold at 15 and is now in the neighborhood of 70.

CHICAGO SHOW NEXT BIG ONE

As is customary both the big Coliseum on Wabash avenue, and the First Regiment Armory, on Michigan avenue, will be utilized for the Chicago Automobile Show, which opens in that city on January 23 and continues until January 30, inclusive. Manager S. A. Miles promises the biggest display ever held.

COLUMBUS AUTO SHOW

An automobile show will be held by the Columbus Auto Trades Association, sanctioned by the Columbus Automobile Club, at Memorial Hall, Columbus, O., January 30 to February 6. Pleasure cars, motorcycles and accessories will be exhibited.

The L. J. Muttly Co., which manufactures rubber fabrics and tubing, has moved its executive offices from 93 Federal street to 175 Congress street, Boston.

MOTOR VEHICLES TAKE VITAL PART IN FIGHT

Prove Essential Factors of Modern Warfare in Swift Campaigns

The work of the motor car in the great conflict is being studied with interest by the automobile expert as well as the military authority. An intimate picture of the daily life of the war motor of sorts is presented in the following report from the front or just back of it, dated "Flanders," by John Prioleau, the automobile expert of The London Daily Mail:

The Allies and the Germans live on their motor car service.

The chief point which strikes one about the efficient modern war car is its lack of anything unusual in design or construction. Since I have been within reach of the great war I have seen practically every kind of motor vehicle used by both sides, from the heaviest lorries to the motor bicycles of those wonderful dispatch riders who have played so important a part in the campaign, and the impression left on my mind after three months is that, so far, the ordinary touring car has scored in a way which no amount of competition winning in peace time could equal.

In the particular region in which I am writing and in which I have best been able to study the question, the great majority and the most important section of the cars used for the fighting armies are, originally, ordinary touring cars, such as you may buy in any motor shop. They have special bodies fitted to them, ambulance bodies, wagon bodies for food and ammunition, bodies designed to carry dismembered aeroplanes, their stores, spare parts, and mechanics, and a score of heterogeneous kinds of coachwork adapted, on the spur of the moment, to carry anything. But the chassis, the engine and running gear are what dealers call "absolutely standard."

There is no doubt about that. One can see a hundred times a day a huge, heavy Red Cross body, built to carry four wounded men with their attendants, painted English khaki or Belgian army biscuit color, mounted on a touring chassis whose wheels still show the exquisite finish of the showroom, maroon with gold lines, or pale amethyst picked out in white.

And how magnificently they do it! How justly proud their makers would be if they could see them! The work to which the war cars are put is nothing less than murderous. They are driven enormous distances in the shortest possible time, over roads of an indescribable badness; they are usually granted no sick leave; and I have never yet seen a driver give the smallest attention to the mechanism of his car beyond what is strictly essential to insure the day's work. He never has time. Day after day, night after night, they must go, and keep on going, and they are always in a hurry.

A car must go from, let us say, Furnes to Dixmude, with a big load; return light; take back ammunition and half a dozen men; bring back a dozen—make perhaps ten trips in the dark. The road consists of a narrow strip of excessively bad cobbles, flanked by mud tracks. If you skid off the cobbles your driving wheels drop a good six inches into this mud, and you have a hideous struggle to get the car back into the middle of the road and on an even keel again. The only way of being certain—more or less—of keeping on the cobbles is to drive slowly, which is out of the question.

And at every hundred yards or so a yawning hole, eight feet wide and three feet deep, stretches across your path where a Jack Johnson fell. If you have any lights at all you generally carry a single headlight of very moderate power. But the car must get there; it must do it at what would rightly be called in peace time a criminally reckless speed; it must do it again and again till further orders, and it must not break down.

"If it does it is pushed into the ditch and left there. It becomes simply a casualty. It drops out of the ranks. And when one thinks that over one certain area of about 800 square miles some hundreds of cars of this type are in hourly use, and that there have been only half a dozen "killed" casualties re-

ported since the beginning of the Calais campaign, one forms a fairly definite idea of the amazing excellence of the modern car.

They are of all sorts and conditions, these war cars—English, French, Italian, Belgian, American, and several German—the last-named prizes captured on the open road. The horsepower varies between 15 and 40, but the great majority are of the 20-25 horsepower class. There are cheap cars and expensive cars, good cars and bad, as we used to call them before the war. You will see a fleet of six ambulance cars, identical in coach work, but mounted on chassis varying from the \$975 American to the \$2,500 English or French.

Yet they do all their work, and do it marvelously well, without distinction of price or nationality. In the last two months I have come across only three cars in difficulties other than tire troubles—and even these last have been astonishingly rare. All honor to the homely touring car. It is as good a soldier as any, and we should be in a poor way without it.

Upon the ordinary touring car chassis falls the brunt of the work, but the ranks of the motor army contain many sections which do their duty equally well. The heavy lorries which carry stores and ammunition from base to trench are as indispensable as the guns which fire the shells and the men in the trenches who eat the provisions which are brought exactly where and when they are wanted.

I was talking the other day to the driver of a heavy ambulance car, a man who in ordinary times drove a large family car which lived in one of the home counties. The car now under his charge was of exactly the same type as the limousine he drove about the Surrey lanes before the Kaiser ran amuck, and his amazement at "what the old 'bus can do" was enormous. An ordinary full load—wounded, stores, medicaments, spares, and men—exceeds, he calculated, the peace load by a good 100 per cent.

Apart from the special heavy lorry, which is at present in the minority, the true war car, as I judge, is the peace car in khaki. And the more we have of them the better the fight we can put up to the enemy. Any horsepower over 20 seems to be adequate.

In the body work there is one suggestion which could be made with due deference to the author of the official regulations, and that is in the protection afforded to the driver. It is of the first importance that the man in charge should be as warm and dry as possible.

The practical German foresaw the possibility of winter finding his army still many miles from Berlin, and all his transport cars and wagons have properly inclosed driving seats in which the driver sits in comparative comfort. Long days and freezing nights at the wheel are not allowed to handicap the work of the Imperial Transport Service, and they must be made as innocuous to our men.

ENGLISH LIGHT CARS RISING IN PRICE

Public Realizes That Economy Lies in Low Upkeep, says Motor Expert

Not the least remarkable feature of light-car development in England, as evidenced by the material brought forward for the 1915 season, is the fact that the price limit continues to be of wider range in an upward direction, according to H. Massac Buist, motoring expert of The London Morning Post.

When the light car was talked of a couple of years ago, he writes, a number of those interesting themselves in the motoring movement could see nothing in it, for the reason that they assumed a light car must cost not more than \$500 complete. They realized at that time that it was impossible to produce a really satisfactory and reliable vehicle for so small a sum of money. There is still a very appreciable school that argues that nobody would think of buying any light car on the market in face of the fact that you can purchase the cheapest form

of American car for a considerably smaller sum than the cost price of the average light car.

That school, however, is also being proved wrong in practice. Nor is this surprising. The purchaser who requires a light car is not in quest of such a vehicle solely because of its initial cost price. Probably because he is desirous of having as much motoring for as low an expenditure as possible, he puts on his thinking cap and gives a considerable amount of study to the matter. He realizes that it is cheaper for him to think and study than it is to pay away money and find out afterward that he has made mistakes.

This potential motorist, who represents an extraordinarily large class, realizes that the cheapest form of automobilism must embrace at least three features. First is durability, so that the machine shall have long wearing life, require a minimum of attention, and give satisfactory service, involving the expenditure of a minimum amount of money on replenishment of parts through mere wear, and nothing whatever under the heading of repairs, because there must be no parts that will break or otherwise fail.

Secondly, he must have a machine that will work economically, therefore it must be light, despite the fact that it must also be very hardy, for the tire bills and the gasoline ones must be wholly on the light-car scale.

Thirdly, he realizes that if you were to give him any form of motor car of the middle size, American or otherwise, still he would have no use for it, because though it should cost him nothing to acquire it, it would at least cost him middle-car charges for maintenance, repairs, housing, licensing, and so forth.

RUBBER MEN HOPE TO RAISE EMBARGO

Bertram G. Work on Way to England to Deal Directly with British Government

Among the passengers aboard the Lusitania, of the Cunard line, which left December 30, was Bertram G. Work, president of the B. F. Goodrich Co., of Akron, O. Mr. Work is carrying the hopes of the American rubber industry, since he will continue directly with the British government the negotiations which the Embargo Committee has been carrying on at Washington for the last two months.

When the British government first placed the embargo on shipments of crude rubber from British ports to the United States it was regarded as of little importance by many, but others took it more seriously. A joint meeting of rubber manufacturers and importers representing the majority of the trade was held in New York early in November. It was recognized that spasmodic individual efforts would be of little value in dealing with an international problem; therefore a joint committee, called the Embargo Committee, was appointed, consisting of George B. Hodgman, president of the Hodgman Rubber Co.; Arthur H. Marks, general manager of the B. F. Goodrich Co.; H. Stuart Hotchkiss, manager of the General Rubber Co., and representing the United States Rubber Co.; William E. Bruyn, of L. Littlejohn & Co., representing the importers, and H. S. Vorhees, secretary of the Rubber Club of America, acting as secretary of the committee.

This committee received a free hand and it has spared neither time nor expense in its efforts to learn the real cause of the embargo and to find means of removing it. Since that time its efforts, through the State Department and the British Embassy at Washington, have been most persistent.

A co-operating committee was formed of the leaders of the trade in London, which worked direct with the British government, keeping in constant cable communication with the American committee. The problem appeared simple at first, but soon was found to be very complex. After six weeks of constant effort, in which the committee has had the best of co-operation from our State Department and from Sir Cecil Spring-Rice,

the British Ambassador, the real issues involved in the embargo are clearly defined. The Embargo Committee, feeling the desirability at this stage of having its arguments and its carefully worked out system of guaranty presented personally to the head of the British government by a representative American manufacturer, has arranged with Mr. Work to lay its case before the highest authorities in England.

AKRON HOLDS FIRST AUTO SHOW

The Akron Automobile and Electrical Show, the first of its kind, was held from December 12 to 19. Practically all of the local rubber companies exhibited, in addition to a showing of the products of the leading automobile and accessories manufacturers of the United States. The exhibits represented a value of more than \$300,000. Nearly 50,000 people visited the exposition. A permanent organization to promote a similar show each year has been effected and the substantial support given the promoters this year will enable them to begin 1915 with a surplus. A modest dividend was declared on the first show. The members of the organization are E. T. Jones, Andy Auble, Jr., C. C. Welker, G. W. Funk and W. L. Stouffer.

FOR AMBULANCE DESIGNS

Prizes Offered in England, Open to All Nations—Highest \$5,000

According to a London dispatch to the New York Times, under date of January 9, three prizes of, respectively, \$5,000, \$2,500, and \$1,500 are offered for the best designs for an ambulance body which will fit the standard motor chassis for field work.

The prizes are offered by Henry S. Wellcome, and Sir Frederick Treves, the famous surgeon, will act as chairman of the adjudicating committee, which will include military and naval experts, and representatives of the Red Cross societies.

The last day for the receipt of competing designs is June 30, 1915. The competition is open to all nations.

NEW COMPANY TO MAKE OVERMAN TIRES

The Overman Cushion Tire Co. has been incorporated with a capital stock of \$150,000 to succeed the Overman Tire Co. now in the hands of receivers, and has temporarily located at Belleville, N. J., with office and salesroom at 250 West 45th street, New York, the old factory at Passaic having been given up. The new concern will manufacture only the Overman cushion tire, discontinuing the pneumatic type. The officers of the company are: C. A. Taussig, president; J. B. Bleiler, vice-president and sales manager; Mac C. Overman, treasurer and general manager; Alexander Clogher, secretary.

GOODYEAR'S REMARKABLE RECORD

Figures showing the tire production of the Goodyear Tire and Rubber Co. for the past six years have recently been compiled and sent to the trade, together with a chart showing, in the form of pictures of tires of different sizes, how the productions compared, beginning with 1909.

In that year Goodyear made and sold 102,669 tires; in 1910 the figure was 207,442; in 1911, 332,458 tires were made; in 1913, 1,132,869 was the number, and in 1914 these figures were topped by a production of 1,478,396. This accounts only for the pneumatic tire production of the company.

NEW TIRE PLANT FOR AKRON

Another rubber company will be started in Akron, O., with local men operating it, to make automobile tires. It will be known as the Rubbertown Tire Co. The capital is \$10,000. O. J. Schwab, M. Greenberger and J. F. Darcy are interested.

STANDARDIZED FARM WAGONS

A Dream That in 1940 Few Sizes and Styles Will Be Manufactured

You ask me to be a wagon dreamer and set the automatic to ring off at 1940, so I have "wound her up" and here goes.

There have not been many radical changes in farm wagon construction since the four-wheel type came into use. Much thought and effort have been expended, however, on increase of strength, greater durability and refinement—all of which is commendable and no doubt the results have justified this expenditure.

The manufacture of farm wagons began originally in the small shop of the blacksmith or wheelwright and each builder incorporated into the wagon he largely built himself his own ideas of the value of proportions of both wood and iron. Everyone claimed for his own make superior qualities of material and workmanship. As the country developed the buyers of these wagons migrated to cheaper land and fresh fields and generally carried with them the wagon built in their home shop and of which they were justly proud.

Thus a great variety of sizes and kinds was spread the country over and doubtless each owner insisted that his particular one was the best. A neighbor seeing some special feature that impressed him persuaded the all-too-vulnerable builder of the next wagon he bought to add that feature in his case; and so it grew until now every wagon manufacturer takes pride in pointing with flaming red arrows to the hundred and one "reasons" why his wagon is the best.

In those early days the farm wagon was used to carry the family to church, the boys and girls to the husking bee, and the drive to town with the "gude wife" to do her Saturday shopping was always in that same wagon, writes H. H. Kinney, manager of Winona Wagon Co., in *Farm Machinery*. Of course it had to be well finished and elaborately striped and varnished.

Times have changed; most farmers have one or two top buggies or spring wagons and many are now annihilating the space from farm to town in an automobile. The farm wagon has been relegated entirely from the sphere of pleasure to that of plain work.

As a result of catering to the whims of about every individual buyer, all the larger wagon factories today are compelled to make, and hence carry in stock, immense quantities of raw material and finished goods that they may give their customers satisfactory service.

It is rare that these factories receive an order for a carload of 25 wagons that there are not at least ten different sizes and in many cases there are 18 or 20 sizes or kinds.

Thus far I have been dozing—now for the dream.

In a prosperous section of the middle west a well-to-do farmer sets the brake on his six-cylinder motor car before the door of the implement dealer in his nearest town. The dealer, alert and with both eyes open for business, meets the prospect at the curb and extends a welcome that holds his attention until he is safe from interruption.

The usual family and weather questions being settled to the satisfaction of both parties, the farmer says, "Williams, I am going to buy a wagon—what make are you handling?" The question was unnecessary, for Williams, being a progressive dealer, had advertised "The Invincible Wagon" in his home paper; had often circularized his up-to-date list of prospects, and besides, he had the sign the manufacturer sent him conspicuously displayed. However, he replied, "I have The Invincible—a wagon in which I have the utmost confidence and which I know will give you splendid service. Come out and look it over." They go out to the sample floor and there are set up three wagons, each of a different capacity. The farmer with a show of surprise at once remarks, "Is that the way your fine wagon is finished, Williams? Looks mighty common to me. What sizes are they?"

"Well," Williams replies, "there has been a big revolution in wagon building the past few years—guess you have not paid much attention to farming lately, have you?"

"No, to be honest about it, I haven't, for I've been back in the old country for a couple of years, besides being east a year or two more—but what's been doing?"

"You see it's like this," was the answer. "There got to be so blamed many sizes and kinds of wagons with all the different heights of wheels and widths of tire that neither the manufacturers nor the dealers could carry stock enough to fill an order or satisfy a customer and it was a mighty expensive and unsatisfactory state of affairs.

"Something had to be done, so after getting the hearty endorsement of the dealers a few of the practical wagon men got to experimenting with a view to simplifying and standardizing construction. Why, it was so bad that a difference of two inches in the height of a wheel would kill the sale of a wagon in one town whereas it was mighty popular in another only a few miles away.

"Well! As I was saying, and to make a long story short, these fellows—and mind you, after spending many months and doing a lot of experimenting—finally boiled it down to four wagons and that's enough kinds for everybody. Now we have the light wagon, the medium, the standard and the heavy. I don't carry the heavy one as there is not much sale for it around here. These are all the two-horse wagons any dealer need carry and any farmer can find what he needs in that variety."

"That sounds mighty sensible, Williams, but I see they cut out the fancy painting, too—what's that for?"

"The idea about that is this—what's the use of putting a lot of expense in making a wagon handsome? You want a wagon for business, not for show.

"Farmers don't haul their wedding parties in wagons any more—they do as you do, take them in something more up-to-the-minute. A carriage or an automobile will stand a high finish, but it's throwing money away to put it on a farm wagon.

"So they got up a system of painting their wagons that answers the main thing, and that's to preserve the wood and keep the iron from rusting. It ain't quite as handsome but it's mighty durable.

"But this isn't all the advantages that have come out of this movement. We can give so much better service both on wagons and extras and so can the manufacturer. Both of us can carry a stock of this smaller assortment so as to fill orders in much less time than ever before."

"Looks different now, Williams. I want a standard wagon this time. What do you say the price is? Certainly, I'll pay cash for I want my money to go as far as possible."

But though it's not 1940 yet by considerable—somebody is cutting in and I guess I'd better wake up.

THE LINCOLN HIGHWAY

It is expected that by the spring of 1915 markers will be in place every inch of the way over the great Lincoln highway from New York to San Francisco, and that the 3,400 miles stretching between will be one long continuous route in perfect condition.

In its wonderful sweep from ocean to ocean it takes in 13 states, all brought together by the great highway, but more than the vast distance it covers is the infinite variety of scenic beauty found on the route. For as the memorial road stretches along from New York to California it winds past meadows and cornfields, crosses great rivers and mountain passes, and trails through woodland and prairie and desert.

And tourists, farmers, travelers on the mighty highway will not be left to guess the inner significance of the Lincoln way.

The markers are painted and stenciled in three colors, red, white and blue. A large letter L in blue, stands out on a background of white, with a strip of red above and of blue under-

neath, and with the words Lincoln highway in smaller letters—eight or more of them to the mile.

And besides the markers, states, counties and municipalities have lent distinctive hands in making contributions to add to the beauty of the memorial. Chambersburg, Pa., South Bend, Ind., and other places through which are road passes have erected memorial arches, and many towns have put up large signs telling tourists the name of their community and some bit of information that they assume travelers will be pleased to learn. In Canton, O., for instance, strangers on the highway are reminded that that is "the last resting place of William McKinley."

If all the highway is beautiful as are some parts already, we Americans need not travel oversea for a glimpse at the fairyland of highways.—Buffalo Express.

FREIGHT RATES INCREASED

Increases in freight rates, approximating 5 per cent. on all the railroads between the Atlantic seaboard and the Mississippi, north of the Potomac and Ohio rivers, were granted December 18 by the interstate commerce commission in a divided opinion, excepting on certain heavy commodities which comprise a large bulk of the traffic—coal, coke, and iron ore—and on lake and rail joint shipments.

The increases will further apply to the railroads west of Buffalo and Pittsburgh, to which partial advances were granted in the decision of last August, which denied them altogether to the roads east of those points. It is estimated the advanced rates will increase the annual income of the roads about \$30,000,000.

The commission made its decision on the showing of the railroads that, in addition to conditions from which they previously asked relief, they now are confronted with an emergency because of the war in Europe.

M. & A. M. ELECT FOUR DIRECTORS

The Motor and Accessory Manufacturers elected four new members to the board of directors at its twelfth annual meeting held at New York City, January 6, at the Waldorf-Astoria. They are as follows: L. M. Wainwright, of the Diamond Chain & Mfg. Co.; E. W. Beach, of the Manufacturers' Foundry Co.; E. H. Broadwell, of the Fisk Rubber Co., and Christian Girl, of the Perfection Spring Co. They will serve for three years and replace the retiring directors, J. H. Foster, of the Hydraulic Pressed Steel Co.; H. E. Raymond, B. F. Goodrich Co.; T. J. Wetzel, Spicer Mfg. Co., and C. W. Stiger, Stromberg Motor Devices Co.

There were about 100 present and the meeting was presided over by J. H. Foster, president.

CELEBRATES THIRTY-FIFTH ANNIVERSARY

The Blacksmith and Wheelwright celebrated its 35th anniversary by making a souvenir number of its January issue. The publication was started by its present owner, Mr. M. T. Richardson, who is one of the best known figures in the trade journal field. Among several other publications started by him is the Automobile Dealer and Repairer, and, like the Blacksmith and Wheelwright, stands at the top of the line it represents. Although born 72 years ago, Mr. Richardson is still a young man mentally and physically.

PIERCE-ARROW PURCHASES SITE FOR MANUFACTURE OF COMMERCIAL VEHICLES

The Pierce-Arrow Motor Car Co., Buffalo, N. Y., has purchased a site at Elmwood avenue and the New York Central R. R., upon which will be erected a plant for the manufacture of commercial vehicles.

WORDS OR WORK

Efficiency is the obtaining of results, and results are achieved by work, not by words. Many employers of men have made grievous mistakes by selecting men who were good talkers over those that were good workers to fill responsible positions. Talk is cheap and requires but little energy; work requires effort and concentration and when a man is occupied with work his mind has little opportunity to frame sentences and carry on a conversation.

Many men talk too little for their own good, but many more talk too much. Handle words with care and use them when occasion arises, but be sure that by their use results will be produced. This is the age for result producers.—Southern Machinery.

VEHICLE EXPORTS

The statistics of exports for the month of October, issued December 17, 1914, show an increase in the exports of wagons of all kinds, 3,316 jobs being sent abroad in October, compared to 1,846 in the corresponding month of the preceding year. The increase in value of the wagon shipments of last October was from \$122,721 to \$530,849. There was also a big increase in the exports of motor trucks, of which 672, valued at \$2,286,964 were exported, against 79 in October, 1913.

CASE WILL MAKE ONLY ONE MODEL

For the year 1915 the automobile department of the J. I. Case Threshing Machine Co., of Racine, Wis., manufacturers of the Case car, have decided to market only one model. With this end in view, they centered all the engineering skill at their command on this one car, with the result that this model will be far in advance of any previous attempt.

FORD SCHEDULE BEING MAINTAINED

The Ford Motor Co. reports that in the four months ending November 30, there were 74,906 Ford cars sold and delivered. This demonstrates that the Ford schedule of 300,000 cars for the year is being maintained.

GOODRICH TO ADD \$5,000 ADDITION

A permit has been granted by the building department of Akron, O., for a two-story addition to the plant of the B. F. Goodrich Co., to cost \$5,000. It will be an addition to plant No. 26.

STORMS ELECTRIC LEASES CYCLECAR PLANT

The Storms Electric Car Co., of Detroit, Mich., recently organized to manufacture a low-priced electric car, has leased the building formerly occupied by the Mercury Cycle Car Co., on Scotten avenue.

That business conditions are improving in all parts of the country, is the claim made by the Franklin Automobile Co., of Syracuse, N. Y. In the first two weeks in December their buying orders increased 42 per cent. over the rate maintained during November. While the better feeling seems to be general, it is particularly noticeable in the cotton states.

N. Charles Barron, until recently branch manager for the E. V. Stratton Co., at Schenectady, N. Y., distributors of Hudson cars, has taken over the Schenectady agency as a dealer, under the firm name of Stratton-Barron Co.

The state of Michigan has improved 2,437 miles of highway since 1910 at a cost of \$7,250,000.

Paint Shop

SANDPAPERING

Twin brother of rubbing roughstuff, the sandpapering task stands at once the dread of the 'prentice boy—if, indeed, that rare little animal continues to exist—and the dislike of the journeyman painter. Even the common laborer lifts up horny hands in protest when assigned to more than a couple of hours of steady sandpapering. Notwithstanding the dislike entertained for this branch of work it promises to demand practice for all time to come, for even in this brave Yankee land, with its wealth of inventors, hand power appears to be the only available energy which can be successfully utilized in reducing the surface of the carriage or wagon to the required smoothness and levelness.

Patent sandpapering devices have from time to time been introduced, but they have, so far as our knowledge extends, received scant favor with practical men. They have lacked the supreme virtue of being thoroughly effective. Despite the fact, however, that sandpapering is an acknowledged universal necessity, and must through force of circumstances ever remain so, paint shop inmates have gone on accepting it as a labor to be performed simply because it cannot be avoided, and scarce worthy of being taken in hand with a view of getting the fullest results which underlie its best application.

The best carriage painters of their time have said with unmistakable earnestness that the finish upon the vehicle is founded alike upon good materials and good sandpapering, and in the last analysis, largely upon the latter.

As a matter of curiosity, the writer once asked a half dozen able and well known foremen painters to define the status of sandpapering in the system of carriage painting, and unanimately they declared it to occupy the superior and indispensable position.

That it is a hard task none will deny. That it requires patience, energy, and skill, all will affirm. Why not, then, give it due consideration from the latter standpoint, and attach to it some of the importance which it by right is entitled to?

In the actual work of sandpapering, much in the way of effective results depends upon the manner of holding the paper. The comfort and saving of one's hands resolves itself also largely upon how the paper is held.

The best results, and the quickest, are to be had by cutting the paper into sizes proportioned to the size of the surface, and then using a single thickness of paper. In this way all inequalities of the surface, hard nibs of dirt or other substances, etc., may be felt by the workman, who, by this same sense of feeling, knows immediately when they have been reduced to the true surface level. In fact, the one thickness of paper acts really in the capacity of a telegraph instrument clicking off, figuratively, the exact condition of the surface as each new chuffle of the nimble sheet discloses it.

Then, so far as possible, the workman should hold the paper in the hand without permitting it to shift its position, save at stated intervals as the requirements of the work may direct. This saves the friction which tends to make the fingers and palms sensitive, and, eventually, sore.

In cutting the sandpaper, the practice should be observed of cutting a smooth edge, otherwise the edge will interfere with the smooth manipulation of the paper, slashing sharp surface edges, where a full heft of pigment ought to be left intact.

A mere manipulation of the paper to the intent of hitting all the surface at some time, and in some way, does not constitute the basis of systematic and uniform sandpapering, although it

is the basis of much of the sandpapering practiced in a great number of shops. There should be, and must be, a purpose back of this work, and that purpose, in a word, is the smoothing away of the roughness, and a reduction everywhere over the surface, of everything that stands in the way of a mirror-like finish. And in this purpose there should be the most careful regard for all the acute angles, sharp edges, and fine points over which an unnecessary or over-zealous rasp of the keen toothed paper would lay bare the wood, to the permanent weakening of the paint structure. This much should be taught the beginner at the outset of his labor along this line. In addition, he should be impressed with the importance of the work, its exact relation to the other processes, and the need of not only his best energies, but his best attention applied to it.

CLEANING PAINT AND VARNISH BRUSHES

A correspondent asks for information on cleaning paint pots and brushes, and the editor has thought it well to have an article dealing with this not unimportant topic. Obviously good painting or varnishing cannot be done with unclean pots and brushes. In the first place I would say, keep them clean. Do not allow them to get dirty. In warm weather paint will be apt to gum up brush and pot if too much driers are used, and there always is, even in cold and wet weather. But this is another story.

Well regulated paint shops have a barrel of strong soda or lye water, in which dirty paint pots are placed, and after soaking a few days are taken out, scraped, the scrapings saved, and the pot made clean with water and rag or waste. Another method is by fire; place some paper or excelsior in the pot, sprinkle a little kerosene over it, and set fire to it; do this where no danger may follow. With care the soldering will not be injured. Scrape with a putty knife as the heat softens the old paint, and do the inside first, scraping down into the slight blaze until the insides are done, then remove the outside stuff. This takes a very little time, and is useful when one does not have time to wait on the action of the lye barrel.

As to the dirty paint brush, there are various ways for cleaning it. Any fluid that will dissolve oil will clean the brush. Ammonia water, creosote oil, benzine, turpentine, fusel oil, hot linseed oil, alkali water, hot water, etc. Some, says *The Decorator*, use the liquid known as paint and varnish remover, but this is very expensive (though it ought not to be, as it is composed of a cheap material), besides which it injures the bristles, taking the life or spring out of the bristles, making the brush flabby and too soft to work well. When the paint is very thick and hard on the outer bristles, do not cut these bristles away, as is too often done, but soften up the old paint, then scrape it away. Benzine and naphtha gum or oil paint, hence are not really good for cleaning the paint brush. If the brush is hard all through then soak it in dilute ammonia or hot oil, then rinse in turpentine and finally wash with soap and water. Or by making a paste with washing powder and covering the bristles with it, leaving it on over night, the old paint will be softened up. Or soak in turpentine and wash out with soap and water, then rinse in clear water, then twirl the brush between the hands to expel the water. Some recommend the use of hot kerosene, after which rinse in ammonia water. Before placing a brush in any hot solution wrap it in paper, to preserve its shape. Hang the dirty brush in hot water, not allowing the water to be above the bottom of the ferrule, and after the bristles have become loose from paint work same with the fingers, separating the bristles as much as possible. Repeat

the hot water treatment until the heart of the brush has softened. Next place the brush in turpentine to soak a few hours, then take it out and work it out with a putty knife, removing the loose paint. If still there is hard or only partly softened paint, place the brush in some strong soap suds and boil until old paint is soft. Heat or hot water is a great softener of paint. When I have a lot of hard lead or zinc white and want to mix up a pot of paint, I take the hard paint out of the keg in small bits and place it in the mixing pot, then pour boiling water on it until the hard pigment is covered; I set the pot away for anywhere from 15 minutes to an hour, as it does not require a very long time, and then the lumps of lead or zinc are quite soft and may easily be mixed up with oil or turpentine in the usual way. I don't think many know of this little trick, and I only stumbled across it myself experimenting one day. Old paint, dried on pot or brush will not soften up as quickly as the hard lead, yet with boiling and time it will, particularly when assisted with a little alkali.

When the varnish brush gets foul the old stuff may be best removed by soaking in varnish remover. As this liquid evaporates very rapidly it is best to have a can that may be covered during the operation. While the liquid may have some bad effect on the bristles, yet as varnish aids in stiffening the bristles it does not matter much. Turpentine, and all varnish is presumed to contain some, acts as a stiffener on bristles, so that it is advised when your paint brush becomes flabby from being too long in water that it be used in turpentine paint or stain for a time.

When done with paint brushes for the day or time being, remove all paint from it by wiping it against the edge of paddle or putty knife, and wipe off any paint from ferrule and handle, before putting it away. Water is usually employed for keeping paint brushes in, but if the brush is simply wrapped with wet paper or muslin it will not become dry over night, and the bristles will be in a better condition than if kept in water. If done with the brush for a season, better clean it out with benzine and possibly with soap and water, let it dry perfectly, then place in a drawer or cupboard until again needed. Nothing ruins a brush like soaking in water for a long time.

IN THE OLD DAYS

In working in different shops and with eyes open to learn, the young painter anxious to get on can always add something to his store of knowledge.

In my experience of between 20 and 30 years in the atmosphere of paint, I have worked alongside of a good many men, good, bad, and indifferent, writes a veteran carriage painter; but I think I can safely say I never met a man yet (even those who had no pretensions to front-rank place) who had not got hold of some little knack or trick in connection with his business, which was not worth making a note on.

As a rule, personally, I have found all information needful given as to the how and the why. On rare occasions, perhaps, the conservative old painter may "shuffle the question," but even he, if appealed to in the right way, will throw out and open the flood-gate of his knowledge upon you.

I have in mind, as I write this, of such an one whom I knew in my early ambitious career, at which time the art of the mixer and colorist was perhaps more necessary to the painter than nowadays, when colors of all hues are manufactured by specialists, who vie with one another in giving the painter an article which he could never hope to get by the aid of the antediluvian stone and mortar process, thereby lightening his load by doing away with a big item in the drudgery of the paint shop.

Now, when this old painter had any pet color to get into shape, a job in a remote corner of the shop could generally be found for the boy with inquisitive eyes, and these mysteries and others were studiously kept from him for some considerable time; perhaps he had in mind the pearls-before-the-swine story, or maybe, with a knowledge of human nature, he may have

thought that such reticence would only help to whet the steel for use when edge tools were more capable of being handled.

I like to think the latter was the case, as little by little, through consistent, almost dogged attention and perseverance to his work, the boy eventually won the man's confidence and esteem, and for many years a lasting friendship resulted between them.

The young aspiring painter of today has a fairly tough row to hoe to get to the top, and every advantage must be taken to "get there": diligent home practice and trade journals are steps in the right direction; careful study of the work of good painters, whether they be panel magicians, scroll painters, letterers or liners. Knowledge is carried in small bulk, and no man can afford nowadays to throw away any chance of acquiring that which will benefit him.

Recollect that the term coach painter covers some ground when writing, scrolling, lining, faultless panel work, and varnishing par excellence are a part of his stock in trade. However brainy a boy may be, there is no royal road to paint education, any more than any other accomplishment.

LETTERING

Good wagon lettering, outside of the large cities, is by no means common. This can be accounted for from the fact that the painter in the small shop cannot give his undivided attention to lettering, getting his knowledge from time to time from work that attracts his attention.

If the wagon painter would strive to master the fundamental styles (which are: the Egyptian, Antique Egyptian, Roman, full block, round block and half block) as the sign painter does, and then to modify them to suit his requirements, the art, to a great degree, will have been mastered, and any desired originality can be obtained.

By thoroughly mastering the fundamental styles the student can easily trace all the variations to the different styles from which they have been derived. I believe that in good wagon lettering the layout should be kept well within the limits of the panel, allowing plenty of room or margin for any striping or ornamenting which may be desired.

Letters with a stroke one-sixth of the height of the letter are of a good proportion for wagon work, and then, if they are shaded, they will not appear like blotches from a distance. Strive for simplicity and accuracy, as legibility is the first consideration to be observed in the formation of letters, and the laying out of work, though ornamentation plays its part in making letters attractive and if used judiciously will aid the painter in obtaining artistic effects. A plain, attractive job of lettering may well be likened to a neat, plainly dressed girl; she is in this attire more attractive than if bedecked with other ornaments that would only detract from her beauty.

Good wagon displays serve a twofold purpose—first, the name of the firm, etc., and, second, in making the display so attractive and original in character and design as to become a fixture in the mind of the observer. The merchant should consider that wagons are fixtures and are seen by a great number of people, and that, while careful attention is given to the elaborate fittings and decorations within and without the store, he should display more than a half-hearted interest in the attractiveness of his wagons. The successful merchant does consider this important point.

Condensing is a term applied to the closing up of the letters; that is, making the letters narrower than their normal width. In conforming letters to a required space it is frequently necessary to condense them. When the panel to be lettered is not long enough to allow of the regularly proportioned letters, they must be made sufficiently narrow and close enough together, without appearing ungainly or out of proportion, to come well within the space allotted.

There are several styles that are suited for this purpose; the Egyptian, plain and antique; French, Roman, half block, and

to some extent, the full block. Good lettering is good design. Each letter has a character all its own, and this must be preserved in spite of any variation that may be indulged in. The Egyptian alphabet is often incorrectly called the gothic; they have no resemblance.

Do not draw one portion of your lettering carefully and another part in an off-hand manner to lessen the value of that part. The whole should be treated carefully or otherwise. Good lettering means simplicity of style and uniformity in effect. It should be striking, legible, accurate and neat.

LEAD POISONING

Many painters do not realize the danger of lead poisoning from white, black and red lead paints. Outside of cuts, the most accessible place for the lead to enter is the flesh around the finger nails. Its entrance there can be prevented by dipping the finger tips into warm paraffin, or beeswax, whereupon gloves are put on and one proceeds with the work. The paraffin can be easily removed when the work is completed, or at the end of the day.

Guard against draughts when varnishing, in cold weather. It is just as easy to varnish in cold weather as in warm if the temperature of the shop be right. Keep the varnish warm before and while using it. Watch the thermometer closely, that you may keep an even temperature. The escape of gas at night, when the fire is low, does great damage to varnished jobs. Keep the fire bright as possible, night and day, but be careful of fire at night.

NEW BUILDING FOR GUSTAV SCHAEFER WAGON FACTORY

A new four-story \$50,000 structure has just been completed for the Gustav Schaefer Wagon Co., at 4180 Lorain avenue, Cleveland, O. The building is modern in all its appointments, all the walls being of brick while the floors are of steel and concrete.

The different departments on each floor are separated by sheet-metal fireproof doors, while the windows are steel framed and the roofing fireproof.

One of the features of the new plant is a \$6,000 electric all steel platform elevator, said to be the largest in Cleveland. The big hoist is 26 feet long and 10 feet wide. Its weight is 7,500 pounds while its capacity is 15,000 pounds. The building is heated with the Vapor Vacuum Steam Heating system, with the Bishop-Babcock-Becker Co.'s vacuostat valves and electric pump. Another feature of the vehicle plant is the boiler room, smoke from the fires being carried downward under the concrete floor by means of an electric suction device causing an artificial draft delivering the fire fumes and smoke into the big smoke-stack.

"In the old plant we experienced considerable difficulty in handling heavy and cumbersome wagon and auto truck accessories," explained Mr. Schaefer. "Now, if it is necessary to lift an engine from an automobile in order to make repairs, or to lift the entire body off a chassis one man can do it. A short time ago it required from five to ten men."

Another interesting spot is the paint room. All mixing and coloring is done in one room. The different ingredients, contained in receptacles on the fourth floor, travel to the paint room on the third floor through tubes, thus affording much convenience and eliminating congestion. The third and fourth floors are to be used exclusively for painting and finishing.

Mr. Schaefer asserted that when established in the new plant the company will be able to repair anything on wheels that travels the public highways, barring street cars and the like. The building will be ready for occupancy in all departments shortly after the first of the year.

VEHICLE CLUB GETS CHECK AND OPTIMISTIC LETTER FROM DURANT-DORT CO.

F. M. Staples, secretary of the Flint (Mich.) Vehicle Factory Mutual Benefit Association, received a letter from the Durant-Dort Co. on December 23 accompanied by a check for \$200 to be applied to the payment of dues or fees of Durant-Dort employees who are affiliated with the organization for such a period as it will cover. The letter is as follows:

"A year ago this company expressed its wish that joy and happiness might attend our employes and your organization throughout the coming year, and now hopes that in reviewing the year you may find the wish has been measurably filled.

"A new year is ahead of us and there is in the atmosphere a distinct tone of optimism, of confidence, of increase, of prosperity, and of expanding opportunities in which we are all to participate.

"May we enter that new year better prepared for its successes by a hearty adaptation of the Christmas spirit of good will to all, and that is our earnest feeling toward every employe of this company and of your splendid organization.

"We enclose you a check for \$200 to be applied to the payment of dues or fees of our employes who are affiliated with your organization for such a period as it will cover them."

Sincerely yours,

DURANT-DORT CARRIAGE CO.

MITCHELL WAGON COMPANY ENTERTAINS

Traveling Representatives Combine Business and Pleasure in Four Days' Session

The traveling representatives of the Mitchell Wagon Co. were entertained on December 15-18 at the company's plant in Racine, Wis.

John D. Howell, general manager, had charge of the gathering, 22 in number, and one of the large buildings of the company, in which daily meetings were held, was handsomely decorated for the occasion.

The business sessions were held from 9 to 12 o'clock in the morning and from 2 to 5 in the afternoon. Addresses were given and many papers read pertaining to the wagon trade and the topics were discussed.

Tuesday evening was an open house at the offices of the company, where a real "get together and become better acquainted" was in order.

On Wednesday evening there was a theatre party at the Orpheum theatre.

Thursday evening there was a banquet in the Hotel Racine dining room, and it was a brilliant and enjoyable event.

The wagon company is nearly 80 years old, and General Manager Hollowell arranged a number of interesting and important features in connection with the progress and growth of the institution.

A souvenir book, filled with cuts, shows one picture of 127 employes, 19 of whom have been with the company 50 years, and others from 30 to 40 years, 20 to 30 and 10 to 12. Another shows the 615 employes in a group.

The company also had on exhibition a wagon 65 years old. It was made for the Paris exposition by the Mitchell & Lewis Wagon Co. and sent over there. Afterward it was purchased by a man named Thomas Murray, of Kenosha county, from whom the company purchased it about two months ago. It was tested with 1,900 pounds weight and will be exhibited at wagon conventions during the winter.

A picture of this old vehicle also appears in the souvenir book, also views of the factory, exterior and interior of buildings, the lumber yards and wagons in course of construction from start to finish.

The representatives made a trip through the immense factory buildings. The addresses, papers and topics on the program

touched upon every phase of the wagon business, and among the representatives was J. A. Stuart, of Dallas, Tex., who has been with the company 47 years. His subject was "How to Hold a Customer After You Once Obtain Him."

THE MODERN STORM BUGGY

Cosy and Comfortable and Suited to Every Clime and Weather Conditions

That the development of new ideas in horse-drawn carriages has not been arrested by the advances made in other and newer forms of road vehicles, will be evident to anyone who will examine the "storm buggies" being put on the market this winter.

The modern "storm buggy" is not an ordinary buggy by any means. Neither do we mean to convey the impression that it is an ordinary buggy closed in on rainy days by a temporary arrangement of side and front curtains. The storm buggy of today temporizes with no such make-shifts, but is designed from the blueprint to the finished product as a special storm and cold-proof winter vehicle. It is, in truth, a smaller edition of the luxurious limousine.

The wheels, axles and other running gear are practically identical with the regular buggy with which the American public has been so long familiar, and it is in the body and top that the recent improvements have been effected.

Where the body and top of the common buggy are constructed of wood and leather the storm buggy utilizes thin sheet steel, stamped out under tremendous pressure to form the different pieces or panels composing the sides, back, front and roof of the vehicle.

As the rainy days are likely to be dark ones as well, storm buggies are arranged to let in all the available light possible, and to that end large glass windows are placed in both side panels and at the front, with an additional window in the sliding doors which permit easy access from both sides of the buggy. A smaller window in the back panel affords a view to the rear. For night driving there is a compact electric lighting system with batteries concealed under the seat. The usual equipment is two bright headlights and a red signal light in the rear, with a dome light for interior illumination.

The upholstery of the storm buggy is luxurious, comparing favorably with that usually found in the car in which the wealthy city lady rides out to her shopping or to the theatrical matinee. Soft, deep cushions and high, well-formed backs are features of the storm buggy upholstery that mean much in comfort to the occupants. Curtains of a harmonizing color and a thick carpet complete the inside furnishings as supplied by the manufacturers, but bouquet holders, toilet cases and other accessories can also be installed if desired.

Small heating devices, using as fuel a special form of brick coal, have long been used by carriage owners, but until the tightly enclosed storm buggy was invented their full efficiency could not be utilized. Used in a storm buggy, these heaters are capable of radiating a pleasant degree of heat throughout the body of the vehicle, and even on a cold day heavy robes are wholly unnecessary.

Another device coming into wide use is the "inside whipper." When storm buggies first came into use it was necessary to open one of the side doors in order to "touch up" the horse with the whip. The consequence was that, on a rainy day, the arm of the driver was likely to become somewhat wet. This unpleasantness has been obviated by the adoption of an inside whipper, operated through the dash by means of a small lever and a ball and socket joint. When not in use the whip stands erect on the outside of the vehicle and does not annoy the horse.

While primarily designed as a storm and cold weather vehicle, the new type of storm buggy can in a few moments be converted into an open vehicle suitable for fair or warm weather. The two side doors slide back parallel with the rear panels and

the front glass may be dropped or in some cases swing back under the roof and fasten to a hook placed in the roof for that purpose.

On the whole the storm buggy is one of the coziest and most comfortable of vehicles, suitable for every climate and all kinds of weather conditions. It has already become a big factor in the increasing popularity of the horse-drawn vehicle.

BIRCH'S FRIENDS ARE "NE'ER FORGOTTEN"

President Wilson received a Christmas greeting from the American Minister to Portugal, Col. Thos. H. Birch, formerly of Burlington, N. J., and well known in the vehicle world. It consisted of a four-page brochure of buff tinted paper. On page one was printed:

"A Merry Christmas and a Happy New Year, 1914-1915, from Col. Thomas H. Birch, Envoy Extraordinary and Minister Plenipotentiary from the United States of America to Portugal."

On page two was a large picture of a city residence with this inscription:

"The United States Legation, Nos. 20, 21 and 22 Praco do Rio Janeiro, Lisbon."

On page three was the picture of a seaside residence with this caption:

"Minister Birch's seaside residence at Cascaes-by-the-Sea."

On page four was this verse from the Minister's own pen:

When duty and ambition take us far
from friends and home,
In my case they're ne'er forgotten,
no matter where I roam.

REGIONAL SELLING PLAN

The new regional selling plan of the Bancroft Buggy Co., St. Louis, Mo., became effective January 1. The company divided the territory in which it operates into regions, each in charge of a competent sales manager, with a view to giving its customers increased service. The territories and the managers thereof are as follows: Indiana and Michigan, Jas. D. Cathey; eastern states, Russell E. Gardner, Jr.; Alabama and Mississippi, Paul C. Fissinger; northwestern states, Arthur Anderson; Iowa, Nebraska and Kentucky, Andrew J. Clayton; Arkansas, Louisiana and Tennessee, Frank A. Neff; Illinois, Geo. P. Lamy; Texas, Walter H. Yeldell; Kansas, Ben L. Beall; Oklahoma, Homer A. Waechli; Missouri, Paul W. Tutt; Pacific coast, Clifford L. Barnett.

WILL RUN SEPARATE PLANTS FOR AUTOS AND BUGGIES

The Zimmerman Mfg. Co., which has been manufacturing a line of horse-drawn vehicles and automobiles, decided that it was better for each business to operate separately, hence the formation of the new company, the Zimmerman Buggy Co., at Auburn, Ind., for \$10,000, by M. Boland, W. C. Henderson, and A. Schlatter, which will handle the production of the horse-drawn vehicles entirely. The factory will be under the management of John Zimmerman, who has had full charge of the business since the death of John T. Zimmerman in 1910. The Zimmerman Mfg. Co. will continue to manufacture automobiles exclusively.

SECRETARY MANGOLD INJURED

W. C. Mangold, secretary of the Mississippi Valley Implementation and Vehicle Dealers' Association, met with a rather serious accident while returning to his home in Anna, Ill., from a visit to St. Louis on December 21. He sustained three broken ribs and some rather severe bruises. At last accounts he was able to be up and attend to correspondence with the use of the typewriters which he operated with one hand.

S. A. E. HOLDS ANNUAL MEETING**Wm. H. VanDervoort Elected President—Incoming Executive Speaks of Development of Manufacture**

The first business of the opening session of the Society of Automobile Engineers' annual meeting held in New York, January 6, was the report of the tellers of election of officers which made known the election of William H. VanDervoort as the president of the organization for this year. The other officers of the society elected at this meeting were. F. R. Hutton, first vice-president; Joseph A. Anglada, second vice-president; Arthur B. Cumner, treasurer; councilors, Wm. P. Kennedy, C. B. Rose, F. M. Germane, John Wilkinson.

In his address Mr. VanDervoort commented on the difficulties which beset the automobile manufacturer today. In the old steam engine days, the problem of design was based on practically one factor, rigidity. Today in automobile engineering, rigidity and strength are of the greatest importance, but they must be attained with minimum weight and maximum power results. The development of the popular light car would never have been possible had it not been for the ability of the automobile engineers to combine lightness and strength to a remarkable degree. And yet the task is only well begun. Further accomplishment in weight reduction as well as ideal weight distribution will mark the progress of the automobile engineer.

Mr. VanDervoort also spoke of the great reductions in manufacturing cost which now characterize the motor car industry. In fact, so important has this phase of the work become that the automobile engineering profession is being divided more and more into two distinctive engineering classes: designers and producers. The former develop the new designs; the latter are charged with the task of cutting production costs and making possible either the maintenance of high quality in the face of price reductions or improved quality without increased prices.

Parts are now being made at one-fifth their cost of a few years ago. Operations which consumed considerable time and labor in the manufacture of each part are now conducted automatically in relatively less time and at a fraction of the former costs.

Standards Committee Chairman Honored

One of the most interesting features of the annual meeting was the presentation by his associates to Henry Souther, chairman of the standards committee, of a token of the admiration and affection in which he is held. The presentation took the form of a silver piece suitably engraved. It was also announced that Mr. Souther had been made a life member of the society in recognition of his distinguished achievement in the orderly development of the art of automobile engineering.

Mr. Souther was the first chairman of the S. A. E. standards committee. During the four years in which he has served in this capacity, he has built up and coordinated the committee organization, the work of which has been freely acknowledged in this country and abroad to be of unique excellence.

In relinquishing the chairmanship, owing to the press of other duties, Mr. Souther stated forcefully that the work of standardization in the automobile and allied industries has only begun. He made clear the necessity of the executives of car manufacturing companies, as distinguished from the engineers of the same, becoming familiar enough with the S. A. E. standards to appreciate the great wisdom of putting them into full effect in the design and production of motor vehicles for reasons of reduced cost with equal or better quality, and of marked benefit to service departments and car users. Intelligent adoption of well considered standards indubitably results in the saving of many thousands of dollars in a relatively small amount of operation by manufacturer, dealer or user.

A standard, in order to be accepted, must have so much merit that engineers or producers or executives will see good reasons for its acceptance. Good engineering design may be the reason why it is worthy of universal adoption; easy manufacture may

be another reason why it should be adopted and become standard practice; and low cost is a reason why the business organization would say to the others involved that it must be adopted. As a matter of fact all three of these qualities will usually be found in any good standard. The adoption of a standard is not compulsory; it is voluntary.

The manner in which the Society of Automobile Engineers is arriving at proper standards is to get together all those interested in any way and promote such discussions as will result in some decision. Various interests must be involved. There are always at least two—the producer and the consumer. There may be several: for example, the producer of the raw material, the manufacturer who shapes it and, finally, the consumer of the finished article.

The idea that a standard once adopted should never be changed is a mistake if the history of the subject of standardization is of any value. The records show that all standards have changed; some of them very seldom and others frequently.

A truck wheel five years from now may be absolutely different from what is considered a good truck wheel today. Proper standards do not prohibit following design improvement when it comes. The standards committee can be relied upon to direct its energies in the direction along lines which will be for the general good. An engineering standard should be the last word in the particular element involved. Some engineering standards do not specify quality of material but merely shape; the individual manufacturer has to sustain his reputation by maintaining the quality of material embodied in a certain shape. Some manufacturers of steel may have developed a grade of steel of a certain analysis which may have impressed itself on the industry at large, and many people may want to use the steel or something similar to it. If the analysis is known and approved and other steel manufacturers know that the certain steel has a market they are encouraged to produce steel of the same nature, making several sources of supply instead of one. The clear appreciation of the fact that there is a large field for arriving at recommended practices and standards, and for interchangeability of both parts and materials, has resulted in marked simplification of automobile production.

Many New Standards to Be Recommended for Adoption

At the meeting of the standards committee held in conjunction with the annual meeting of the society many new standards were approved for adoption.

The iron and steel division report giving the physical characteristics of many of the S. A. E. steels as well as the chemical analysis was passed in toto. The report suggests the special uses for which the various steels are made up and goes into the matter of heat treatment and machining.

The pleasure car wheels division recommends the adoption of nine so-called even sizes of tires for use by the motor car manufacturer, with nine complementary oversizes for the use of the car owner should he wish to use larger tires. This brings the total number of sizes down to 18, which compares favorably with the list of some 50 odd sizes now in general use. It was pointed out that the manufacturer should adhere to the list of even sizes, allowing the user to equip with oversize tires of he wishes to. If the car is sold with oversize tires as original equipment and the user later on wishes to increase his tire capacity—to take care of the additional weight of a limousine body, or to obtain easier riding, for example—he has no alternative but to use the next size larger tire. This means a change of rims which generally involves a change of wheels and is an expensive and bothersome operation all around.

The standards exchange division submitted a report on standard dimensions for bell housings, looking toward the interchangeability of motors and transmissions. If the recommendation of this report as accepted by the society becomes general practice, in unit power plant construction and a great deal of the bothersome special work which now characterizes this branch of the industry will be eliminated. This means a further

saving in cost of production which will eventually find its way into the pockets of the ultimate consumer.

S. A. E. Investigating Road Taxation Formula

In a report made to the society January 7, the research division of the standards committee disclosed the fact that the U. S. government is now conducting a series of road experiments the results of which will aid materially in the development of an engineering formula for vehicle taxation, based in part at least on road destructive effect. In addition to these data, which will be furnished the division as soon as they are available, the highway commissions of various states have already on file information covering the road destructive tendencies of practically every type of vehicle, both motor-driven and horse-drawn, and it is the purpose of the division to secure the results of these experiments to aid in the determination of a proper formula for road taxation.

It is, of course, realized that between the development of the formula and its adoption by the various state legislatures lies a gulf to be bridged only by the various politico-social organizations interested in the subject. It is hoped, however, that with a universal formula on which to base taxation, something more nearly approaching a uniform tax rate may be established. It is even possible that the much discussed and long hoped for national motor vehicle law will find its inception in the work of the S. A. E. research division.

Electrical Equipment Regulations

The current output and consumption of the various electrical devices used on the gasoline automobile today have always seemed so relatively small that little attention has been paid to the matter of uniform regulation as to installation, insulation, fusing, etc., as in the case of almost every other analogous application of electricity. With the general adoption of electric lighting and starting equipment and the other electric accessories, the use of which is now possible, it is realized that the safeguards afforded the operators of electric apparatus in other lines should be extended to cover the motor car. The electrical equipment division of the society has submitted a report specifying the types and sizes of bulb cases and connector plugs, the precautions to be observed in grounded return installations, protection against short circuits, standard fuses, etc. The report, which was accepted by the society, specifies clearly the exact nature of such things as metallic and non-metallic conduits together with proper uses for same and the provision of proper insulation wherever there is danger of short circuit. It is expected that work along this line will prove a strong factor in the reduction of automobile insurance rates.

New Applications of Gasoline Engines

At the morning session of the society papers were presented on the application of the gasoline engine to freight locomotives and railway passenger cars. Several possible methods of eliminating more or less objectionable gear transmission were suggested. Among these were a locomotive employing compressed air as the power transmitting medium; a design of motor which will produce the maximum amount of exploded gas under pressure to be stored until used in a thermally insulated tank constructed along the lines of the well known vacuum bottle; a type of eight-cylinder motor used in a 50-passenger gasoline-electric railway car for interurban service. It may be interesting to note in connection with the attention now being paid to the eight-cylinder motor for pleasure car use that the designers of the railway motor car in question started with the two rows of cylinders set at an angle of 90 degrees. For a number of reasons, however, in a later design produced to overcome defects discovered in the first motor, the cylinders were set at only 45 degrees. Whether modern pleasure car practice, as regards the eight-cylinder motor will follow this lead is a subject for much interesting discussion and observation.

If dry cells run out quickly, examine the wiring system for a short circuit.

MEETING OF C. C. M. CLUB

Recommend Theo Luth for Important Position—Election of Officers

The annual dinner of the Cincinnati Carriage Makers' Club was a highly successful event, both in the number of members attending and the features of the program. A resolution, presented by the board of governors and unanimously approved by the members, denounced the "pork-barrel" method of framing the rivers and harbors bill, and recommended that this matter be placed in the hands of a national commission of experts.

Congressman-elect Nicholas Longworth was the speaker of the evening. He devoted himself largely to an argument in favor of the reinstatement of a protective tariff, under the subject, "Our Foreign Commerce," asserting that the present depression in business is due not to the war, but to the Underwood tariff law.

Several other speakers were heard, including a number who enthusiastically supported a suggestion, which later was approved by a vote of the club, that Theodore Luth, a prominent Cincinnati vehicle man, be appointed to an existing vacancy on the board of trustees of the Cincinnati Southern Railroad, which is owned by the city. Mr. Luth is president of the Luth Carriage Co., and was for a long time chairman of the freight and classification committee of the Carriage Builders' National Association, as well as of a similar committee of the local organization. His experience in these capacities, as well as in shipping goods for his own house for 30 years, was pointed to as qualifying him for the honor in question.

CLEVELAND FACTORY TO BE USED AS RUBBER WORKS

The Standard Tire and Rubber Co. has purchased land and buildings at Cleveland, O., formerly occupied by the American Fork and Hoe Co., and is making the necessary alterations to convert the plant into a rubber factory. This purchase includes two two-story buildings respectively 360 x 120 and 300 x 60 feet and a two-story wing 90 x 35 feet, with separate buildings for engines, boilers, etc. The capitalization of the company, at present \$100,000, is soon to be increased. The product will consist of solid tires, pneumatic tires and tubes and mechanical rubber goods, and the factory, which will probably not be ready for operation before July next, will be equipped to turn out about 500 tires per day. Its specialty will be the "Flex Steel" inner tire, a device composed of steel and rubber (both made from secret formulas in the possession of the company) and of fabric. The company's officers are: M. J. Gillen, president; George G. Russell, vice-president; C. F. Groth, treasurer; Chas. B. Shaw, secretary. These officers, with E. L. Thompson, J. F. Schulte, E. W. Silver, L. R. Adams and Dr. J. V. Gallagher, compose the board of directors.

"MADE IN THE U. S. A."

The "Made in the U. S. A." industrial exposition to be held in the Grand Central Palace, New York, March 6 to 13, will embrace a complete and diversified exhibition and demonstration of "American made" goods and "American grown" products in practically all fields.

Many leading manufacturers and merchants have declared that the most effective and valuable manner in which to show foreign and domestic trade buyers and also the general public, or consumer, the actual offerings of this country is the exhibition and actual demonstration as provided by an exposition, and this show is scheduled for a time of year when New York City is the mecca of buyers in many important fields from all sections of the United States and Canada.

Special campaigns will be conducted to augment the number

of buyers visiting the city this year at the time of the exposition. These campaigns will include the work of several important export and other organizations to bring foreign buyers from South America and other countries.

The exposition will be held under the auspices of a committee of leading manufacturers and merchants, and its management is in the hands of Harry A. Cochrane, with executive offices in the Fifth Avenue Building, New York. Mr. Cochrane has been selected in view of his previous successes in trade show and industrial exposition organization and management.

The "Made in the U. S. A." industrial exposition is designed to answer a two-fold purpose of value. It is not only to stimulate American trade to domestic and foreign buyers but to educate the American consuming public to our resources and show, particularly, goods that can be obtained from our manufacturers that the American people themselves have heretofore been obtaining from abroad.

MERGING OF TWO RACINE COMPANIES

W. H. Richardson has been elected president of the Racine Carriage Co., a new corporation just formed under the laws of Wisconsin, with \$25,000 paid up capital stock. This new company absorbs the vehicle interests of the Racine Sattley Co., of Racine, and the co-partnership of Richardson-Kennedy Co. Other officers elected are: Vice-president, J. O. Kennedy; secretary and treasurer, J. C. Lund.

The plant formerly occupied by the Racine Carriage and Wagon Co. has been leased for a term of years, and it will be the aim of the new company to continue the manufacture of the high grade wagons and carriages formerly manufactured by this company.

Messrs. Richardson and Lund started at the bottom of the ladder with the Racine Carriage and Wagon Co., and worked their way to the top as officers of the old company, holding these positions until absorbed by the new corporation.

Mr. Kennedy has also been connected with the old company for many years and has had a wide experience.

All the old men in the different departments that have continuously been employed by the old firm, will be retained by the new firm.

A first class repair department has also been established in connection with the factory. In this shop such work as retrimming and painting will be done, special attention being paid to automobiles.

PRESIDENT OF BANNER COMPANY MAKES ANNOUNCEMENT

Replying to Mayor Kiel's statement that large business interests, as well as the city, should do their part toward relieving the condition of the unemployed in St. Louis by opening up their plants, at least on a half-time basis, Russell E. Gardner, president of the Banner Buggy Co., under date of December 26, said he believed the mayor had sounded the right keynote. He stated that his company would open four of its plants January 1. These include the wheel plant on Lombard street, employing 200 men; the buggy body plant in North St. Louis, which would open up with a full force, working ten hours a day; the spring wagon plant, with a full force, and the main plant on South Broadway, also with a full force.

KENTUCKY WAGON CO. ADDS SPREADERS

A contract has just been consummated between the Kentucky Wagon Mfg. Co., of Louisville, Ky., and the Richardson Mfg. Co., of Worcester, Mass., under the terms of which the wagon company obtains the right to manufacture the Worcester-Kemp spreader for all territory in the United States except New England. The negotiations were made by E. P. Curtis, president of the Richardson Mfg. Co., and R. V. Board, president of the

Kentucky Wagon Mfg. Co. It is reported that the latter will increase its force to the extent of 300 on account of the new addition to its line.

AMERICAN WAGON CO. REPORTS PROSPEROUS SEASON

The American Wagon Co., at Dixon, Ill., was closed down for two weeks the last of December. The factory ran regularly during the dull season, and while not employing a large force of men, provided work for the employes up to that time.

The wagon company is said to have enjoyed a very prosperous season and has orders ahead which insures a long run as soon as the inventory is disposed of. The heads of the company deemed it advisable to give their employes a rest during the holidays and start up again early in January.

WILL MAKE WAR KITCHENS

Eight thousand portable kitchen wagons for use in the war were ordered from the Kentucky Wagon Mfg. Co., January 2, by the French government, and work on them was started at once, according to announcement made by R. V. Board, president. The value of the order is placed at between \$200,000 and \$250,000. The wagon company will manufacture the wagon beds, wheels and all other wooden parts of the portable kitchens. Other American concerns have received contracts for manufacturing the utensils and steel parts.

TO SELL LOZIER PLANT FEBRUARY 4

The assets of the Lozier Motor Car Co. on which a value of \$4,000,000 is placed by the Detroit Trust Co., will be offered for auction sale in the U. S. district court room, Detroit, Mich., February 4, at 9:30 a. m., by order of Lee S. Joselyn, referee in bankruptcy.

The sale will include the plant out Mack avenue, all stock on hand, finished cars, patents, etc. The trust company will conduct the sale. A meeting will be held February 5 to ratify the bids.

DETROIT AUTO COMPANY BANKRUPT; WAR IS CAUSE

Petitions in bankruptcy were filed December 28 by the Krit Motorcar Co. and Krit Sales Co., both of Detroit, Mich.

The liabilities of the motor car company are said to be \$881,233, with assets amounting to \$622,533. The sales company liabilities are, according to the petition, \$234,305, and the assets \$256,814. The latter concern was formed to render financial assistance to the motor company about a year ago.

Lack of business due to the European war is given as the cause of failure.

TURNBULL WAGON CO. EXPANSION

The Turnbull Wagon Co., Defiance, O., increased its capital stock from \$300,000 to \$400,000. The new issue will be 7 per cent. preferred, payable semi-annually, and redeemable January 1, 1925, or prior to that date, at the option of the company at \$1.02 and accrued interest. The increase was decided upon following record breaking sales in 1914, and will be used to erect additional buildings and to purchase new equipment.

GEORGE YULE STRICKEN

Geo. Yule, president of the Bain Wagon Co., at Kenosha, Wis., was stricken with paralysis at Los Angeles, Cal. He left Kenosha on December 22, a week previous. Mr. Bain, who is 90 years old, is the last of the "old guard" of manufacturers who put Kenosha on the map as a manufacturing center.

Trade News From Near and Far

NEW FIRMS AND INCORPORATIONS

Harry Hicks and John Combs have opened an automobile and carriage paint shop at Washington, O.

A new implement and vehicle store has been opened at Franklin, Ind., known as the Branigan & Tucker store.

The Sherden Implement Co. has been incorporated at Cambridge, Ill., to deal in vehicles, implements, etc., with a capital of \$7,500, by Wm. Sherden, Ray S. Brown, Rollin Fesler.

The Wagon and Buggy Works of Spartanburg, N. C., have been commissioned by the secretary of state, with a capital of \$3,000. The petitioners are O. L. Johnson and B. T. Legg.

William J. Hughey & Son, Chicago; capital, \$25,000; manufacture, construct, and deal in vehicles of all kinds; incorporators, Louis A. Heile, Charles C. Heckler, Richard C. D'Autremont.

The Oakville Wagon Works have been incorporated at Watertown, Conn., with a capital of \$25,000 to manufacture wagons, by Geo. B. Clark, Nellie W. Clark and Jervis D. Brown, Jr., all of Milford.

The Wm. Frech Co. has been incorporated at Maple Shade, N. J., with a capital of \$100,000, by W. Frech, M. W. Frech, of Maple Shade, and J. H. Parker and E. B. Parker, of Thorofare, N. J., to manufacture wagons, carriages, etc.

The Pull-More Motor Truck Co. has been organized at Augusta, Me., to manufacture and deal in all kinds of automobiles, motors and all kinds of machines, with \$500,000 authorized capital stock. E. M. Leavitt, of Winthrop, is president and treasurer.

FIRES

The Clarksville (Tenn.) Buggy Co. plant was destroyed by fire, December 29.

The carriage factory owned by W. Arthur Mitchell and occupied by M. Barrett, at Elkton, Md., was destroyed by fire.

The Racine Carriage & Wagon Co., Wabash and Eighth streets, Chicago, sustained severe fire loss December 17. This company is independent financially of the Racine company by that name, merely handling the goods of the latter concern.

The plant of the Geo. T. Stehling Wagon Co., at Milwaukee, Wis., was destroyed by fire January 8. The loss was estimated by Mr. Stehling at \$23,000. There was \$15,000 insurance on the building. The carriage factory had been enlarged from time to time and was practically rebuilt a few years ago. The paint shop had been in use many years.

The Hice manufacturing plant at Johnson City, Tenn., was completely destroyed by fire, December 11. The loss is estimated at \$35,000 to \$40,000, with \$13,000 insurance. The plant manufactured wagon and carriage materials, bent wheel rims, table rims and specialties for textile mills, etc., and employed 75 men. The plant was erected in 1911 and had been very successful. A new building, the office building and about \$5,000 worth of unfinished and raw material were saved.

NEWS OF THE TRADE

Business is reported as looking up at the John J. Delker Co.'s buggy factory at Henderson, Ky.

It is announced that Russell Johnson, of Camden, N. Y., is about to reopen the Haywood wagon factory at Newark, N. Y.

The Washington (N. C.) Buggy Co., which has been shut

down for several weeks on account of dull business in the southern states, resumed operations Monday, January 4.

A dispatch from Fort Smith, Ark., reports a local wagon manufacturing company as receiving a large contract from the French government, and that 300 wagon makers have been given employment in consequence.

The new service station of the Youngstown Carriage Co. is now complete and in operation. This new building, which is 44 x 150, gives the carriage company more than 40,000 square feet of space of which about one-half is devoted to automobiles.

The Columbia Buggy Co., Detroit, Mich., will erect a \$20,000 solid brick and steel reinforced concrete building at 27 Selden avenue. The lower floor will be taken over by the Rumsey garage as an addition to their present quarters, while the remainder of the structure will be an enlarged salesroom for the buggy company.

Chas. O. Mainor, of Owensboro, Ky., has purchased an interest in the Winston, N. C., Vehicle Co., and will be associated with J. O. White, president of the company, in the management of the business. It is the purpose of the company to add to the business heretofore carried on, the building of all kinds of auto bodies—both business and pleasure car types.

E. L. Anderson, for 25 years active in the buggy and carriage industry, has retired from active management of the Anderson Carriage Co. plant at Anderson, Ind. Wm. F. Orcutt, of Indianapolis, for 20 years with the McFarlan Carriage Co., of Connersville, will become sales manager, and Frank Ringo will become factory superintendent.

The Oettinger Buggy Co., of Greensboro, N. C., maker of the Guilford buggies, is now making spring wagons for delivery service, and for any purpose a light durable wagon is required. For some time the Oettingers have been making these wagons with much success, but it is not until now that the concern concluded to put forth extra efforts in the manufacture of such vehicles.

The Cutler Hub Co., of Saginaw, Mich., will close and dismantle its plant there, and remove to Traverse City. The company will manufacture hubs for wagons and buggies from white elm, several tracts of which have been bought by the company in the vicinity of Grayling and Bellaire. The plant will start with a force of 20 men. W. M. Cutler and his son, E. L. Cutler, will manage the business.

ANOTHER TIRE WORKS FOR TRENTON

Another tire manufacturing concern has located in Trenton, at Mulberry street and New York avenue. The property at this address, formerly occupied by the American Lamp & Brass Co., has been purchased by the Mecca Tire Co., of Philadelphia, and is being remodeled and improved for tire manufacturing purposes. This property covers about three acres and contains six brick buildings, each 30 x 90 feet, five of them 2½ stories high and one 3½ stories. These will be equipped with the necessary modern machinery to turn out from 250 to 300 tires per day, and give employment to about the same number of workmen. George E. Knowles, of Carteret, at one time employed by the Thermoid Rubber Co., and later connected with the Chester Rubber Tire & Tube Co., of Chester, W. Va., will be general manager of the new concern, whose officers are: Charles Buckley, president; William Fullerton, treasurer; W. J. Cassidy, secretary. The plant will not be ready for operation before March 1.

O B I T U A R Y

Jacob W. Bower, for 60 years engaged in the manufacture of wagons at Lafayette, Ind., died recently at the ripe old age of 85 years.

Clyde M. Edmundson, president of the Galesburg Buggy Co., and one of the most prominent business men of Galesburg, Ill., passed away December 16, after an illness of six weeks. Mr. Edmundson was born May 16, 1879, on a farm near St. Augustine. He was educated at Heading, College, Abingdon, and at Drake University, at Des Moines. After three years spent in the Union Stock Yards of Chicago, he became a member of the Galesburg Buggy Co., and later became its president. He was associated in this company with S. E. Morris, secretary and treasurer of the concern. He was married July 30, 1908, to Miss Florence George, who, with two children, his parents and a sister, survive him.

Alfred Hess, vice-president of the Hess Spring & Axle Co., Cincinnati, O., died at his home in Elmwood place, aged 79 years. Death was caused by injuries resulting from a fall on an icy sidewalk. Mr. Hess was born in New York and had lived in Cincinnati since 1878.

William Tingley, president of the William Tingley Company, wagon builders, Louisville, Ky., and the oldest man in business on Main street, died December 26, at the age of 85 years. Death was caused by heart and kidney disease and came after an illness of about five weeks. He had been in failing health, however, for a year. Mr. Tingley was a native of Newark, N. J., but when a boy moved to Louisville with his parents. At 13 years he became an apprentice in a wagon factory, and went into business for himself when he reached the age of 20. For 65 years he had operated his plant successfully. During the Mexican war he manufactured wagons for the United States army. Mr. Tingley never was married.

Henry J. Wolf, proprietor of the Lake Superior Carriage Works, Marquette, Mich., passed away January 1. Mr. Wolf was born in Prussia, September 24, 1847, and came to this country with his father in 1848, the family locating in Fond du Lac county, where Mr. Wolf's boyhood was spent and where he was a resident until 1887, when he moved to Milwaukee, but Mrs. Wolf died there within a short time, and he then located in Marquette, where he resided several years, having been engaged in the carriage making business, a trade he followed all his life. After residing there a few years, he left for Superior, Wis., and later spent some time in Stevens Point, Wis., and Milwaukee, returning to Marquette again some 16 years ago, when he associated himself with J. E. Richardson in the Lake Superior Carriage Works. The past 12 years he has been the sole proprietor of the business. Two sons survive.

SOME HORSE-DRAWN VEHICLES

Statistics show that there were made on an average of a million to a million and a quarter horse-drawn spring vehicles each year for eight years prior to January 1, 1913, and during the year 1913 the number exceeded 1,200,000. These figures, which are partly due to the increase in population, naturally inspire confidence in the present and the future of the carriage and wagon industry.

It is fair to assume that the vehicle product of 1913 was sold for more than \$60,000,000. A minimum of \$35,000,000 is invested in carriage factories in this country, to say nothing of the enormous capital involved in the wagon business, while the investment in manufacturing establishments making materials and parts exclusively for horse-drawn vehicles is probably as much more.

INDEX TO ADVERTISERS

Backstay Machine and Leather Co.....	40
Cargill Co., The.....	3
Central Mfg. Co.....	40
Columbus Bolt Works.....	4th cover
Correspondence School of Carriage and Motor Carriage Drafting	2
Dowler, Chas. L.....	40
Du Pont Fabrikoid Co.....	3d cover
Eccles, Richard, Co.....	3
Fairfield Rubber Co.....	3
Gifford, John A., & Son.....	3
Hotel Cumberland	39
Keystone Paint & Filler Co.....	3
Lawson Co., F. H., The.....	2d cover
Masury, John W., & Son.....	2d cover
Miller Bros.	40
Mulholland Co., The.....	40
National Spring & Wire Co.....	2d cover
Payne Co., E. Scott.....	40
Pierce, F. O., Co.....	3d cover
Porter, H. K.....	3
Sheldon Axle and Spring Co.....	39
Sherwin-Williams Co., The.....	1
Sidney Mfg. Co., The.....	40
Standard Oil Cloth Co., Inc., The.....	4
Standard Wheel Co.....	4th cover
Stewart-Mowry Co.....	4th cover
Stinson Mfg. Co., The Edward.....	3d cover
Technical School for Carriage Draftsmen and Mechanics..	3
Virginia and North Carolina Wheel Co.....	40
West Tire Setter Co.....	2
White-Quehl Mfg. Co.....	40
Wilcox Mfg. Co., D.....	1
Wiley Co., C. A.....	2

PEORIA SHOW DATES

The board of directors of the National Implement and Vehicle Show Co., of Peoria, Ill., has selected Tuesday, September 28, as the opening day of the 1915 exposition. The show will be a twelve-day affair, closing October 9. There will be four days of horse racing, the board having reached the conclusion that this feature is a good drawing card.

W A N T S

Help and situation wanted advertisements, 1 cent a word; all other advertisements in this department, 5 cents a word; initials and figures count as words. Minimum price, 30 cents for each advertisement.

PATENTS

Patents—H. W. T. Jenner, patent attorney and mechanical expert, 606 F St., Washington, D. C. Established 1883. I make a free examination and report if a patent can be had and exactly what it will cost. Send for circular.

SITUATIONS WANTED

Wanted—Position as sales manager or salesman; 18 years active experience; familiar with credits and every detail of vehicle business. Chas. H. Kelly, care Studebaker Bros. Co., 445 Broadway, New York City.

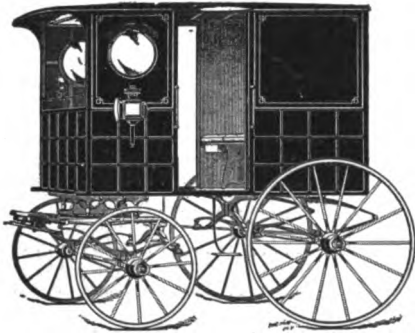

No. 112.—Milk Wagon.

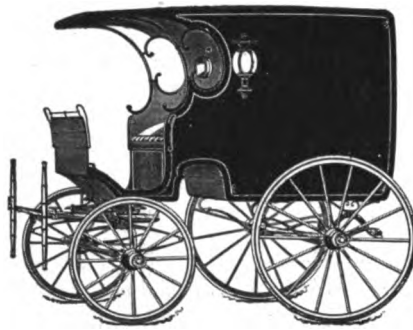

No. 111.—Altman Wagon.



No. 113.—Grocery Wagon.

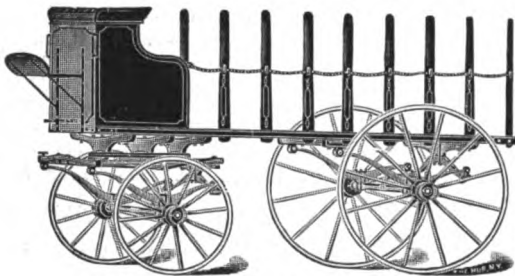

No. 122.—Flour Truck.

Electrotypes

of the vehicles presented on this page will be forwarded on receipt of

75 cts.

for each cut, to any address. Postage prepaid.

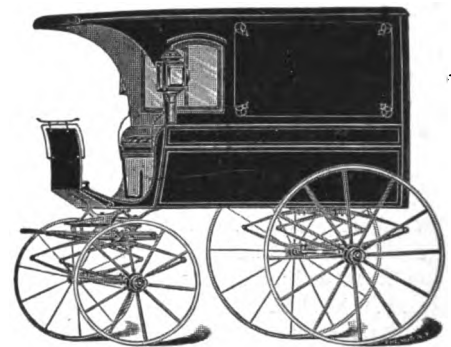

No. 115.—Delivery Wagon.

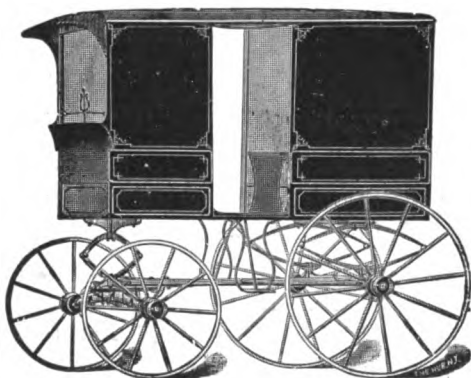

No. 116.—Milk Wagon.

Catalogue

containing nearly 200 illustrations of carriages, wagons, sleighs, and miscellaneous cuts will be sent upon application.

Trade News Publishing Co.

**24-26 MURRAY ST.
NEW YORK**

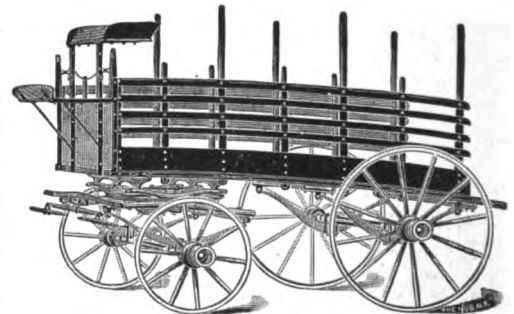

No. 117.—Merchandise Truck.



No. 114.—Delivery Wagon.



No. 124.—Delivery Wagon.

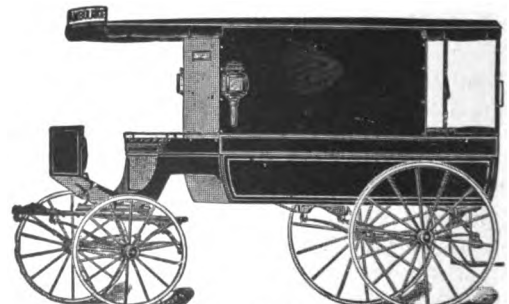

No. 118.—Ambulance.

SHELDON AXLES AND SPRINGS

For Horse-Drawn and Power-Propelled Vehicles of All Kinds

JUST ENOUGH BETTER THAN OTHERS TO BE NOTICEABLE

When you specify "Sheldon" you are not experimenting with experiments, but are getting Axles and Springs with years of manufacturing experience back of them—Axles and Springs that are selected for important work where conditions make reliability supremely important

SHELDON AXLE AND SPRING COMPANY, WILKES-BARRE, PA.

LARGEST AXLE AND SPRING FACTORY IN THE WORLD

HOTEL CUMBERLAND

NEW YORK

BROADWAY AT 54TH STREET

Near 50th St. Subway Station
and 53d St. Elevated.

"Broadway" cars from Grand
Central Depot pass the door,
also 7th Avenue cars from
Pennsylvania Station.

New and Fireproof

Best Hotel Accommodations
in New York at Reasonable
Rates.

**\$2.50 with bath
and up**

European Plan

All Hardwood Floors and
Oriental Rugs

**Ten minutes' walk to
40 Theatres**

Excellent Restaurant
Prices moderate

Send for Booklet



HARRY P. STIMSON, Formerly with Hotel Imperial

Only New York Hotel window-screened throughout

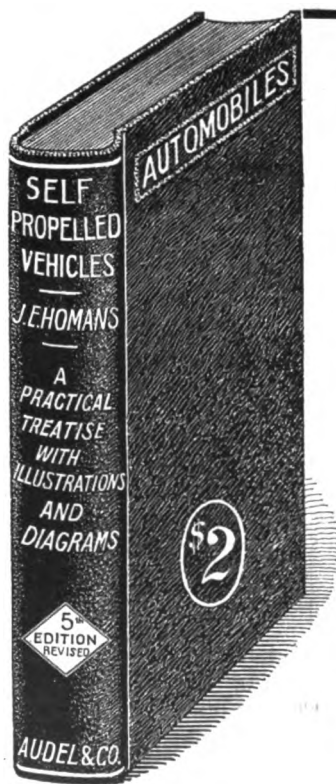

"Self-Propelled Vehicles"

Fifth Edition, Revised.

A practical treatise on the
theory, construction, opera-
tion, care and management of
all kinds of Automobiles.

By

JAMES E. HOMANS, A.M.

Contains 608 pages and
upwards of 500 illustrations
and diagrams, giving the es-
sential details of construction
and many important points
on the successful operation
of the various types of motor
carriages driven by steam,
gasoline and electricity.

This work is now the ac-
cepted standard, explaining
the principles of construction
and operation in a clear and
helpful way. This book will
be sent postpaid to any ad-
dress in the United States,
Mexico or Canada upon re-
ceipt of \$2.00.

Address

Trade News Publishing Co.

24 Murray Street, New York

BUSY BUYERS BRIEFS

CHARLES L. DOWLER
CARRIAGE AND WAGON HARDWARE
108 North Third St., Philadelphia, Pa.
CUSHION MANUFACTURER
Pure Stearic Acid Candles. Wheel Stock. Snow
Flake Axle Grease.

**Sidney Metal Buggy Seats
and Metal Bodies**

The Best in the World
Every Seat Guaranteed
THE SIDNEY MANUFACTURING CO., SIDNEY, O.

**MULHOLLAND
BUGGY SPRING**

Reduces weight of springs one-half.
Made in one size only but will fit bodies
of all widths.
Write for further particulars and prices.
THE MULHOLLAND CO. DUNKIRK, N. Y.



LINED

White's Brazing Sleeves

For applying Rubber Tires
Send for Samples.



UNLINED

WHITE-QUEHL MFG. CO.

431 E. Pearl St.
CINCINNATI, OHIO

STEEL SEATS AND BODIES

Not a Weld, Joint or Seam

CENTRAL MANUFACTURING CO.
CONNERSVILLE, IND.

**AUTOMOBILE
Bodies** AND CARRIAGES
IN THE WHITE

Estimates Furnished on Special Designs
MILLER BROTHERS
Amesbury, Mass.

E. SCOTT PAYNE CO.
Carriage and Automobile
HARDWARE

Horse - Shoers' Supplies
362-364 North Gay St., Baltimore, Md.

Finishing Welts
Bindings
Auto Straps
Shaft Straps

**Backstay Machine
& Leather Co.**
Union City, Ind.

Patent Valances
Patent Prop Blocks
Cut Leather to
pattern in all grades

Subscribe
Now for

THE HUB

**\$2.00
Per Year**

BENT RIMS

Hickory Second Growth and Forest Hickory
All Grades

OAK—STAR BRAND

SPOKES

Second Growth Hickory—Finished and Club Head

SUITABLE FOR ALL VEHICLES, INCLUDING AUTOMOBILES

VIRGINIA AND NORTH CAROLINA WHEEL CO.

8 Bridge Street, New York City

RICHMOND, VIRGINIA

"TRIUNE" COLOR VARNISH

Is strictly a Varnish Product possessing color with the power to Cover in one Coat. It works as freely as straight varnish and will "flow," "level," "rub," "moss" and exhibit in general full durable qualities and working properties.

THREE QUALITIES IN ONE PRODUCT

1—Color. 2—Power to cover in one coat. 3—Straight varnish working properties and qualities. Nothing like enamel or gloss paints. Different, distinct.

Sole Manufacturers

F. O. Pierce Company, New York City

12 West Broadway

Our Constant Aim

IS TO PRODUCE THE

Best Wheels

That can be made
and sell them at a

Reasonable Profit

DON'T FORGET

**You will remember the Quality long
after the cost has been forgotten**

We are Buyers of
Hickory Rim Strips and Spoke Billets

**THE EDWARD STINSON
MANUFACTURING CO.**

327-335 Guilford Ave., Baltimore, Md.

HOW MANY HIDES HAS A COW?

MILLIONS of readers of today's popular magazines and farm journals are reading our advertisements explaining the difference between the worth, looks and service of "coated splits" and



MOTOR QUALITY

Guaranteed Superior to "Splits"

Two years of practical service tests by leading automobile makers gains for it unqualified approval and adoption for 1915 carriages. Carriage buyers will demand FABRIKOID Motor Quality upholstery. Carriages upholstered with "splits" will be difficult to sell.

Get acquainted with FABRIKOID Motor Quality. A small sample **free**. Larger sample (18 x 25 in.) 50 cents.

DU PONT FABRIKOID CO.

Wilmington, Delaware

Canadian Branch: Toronto, Ontario

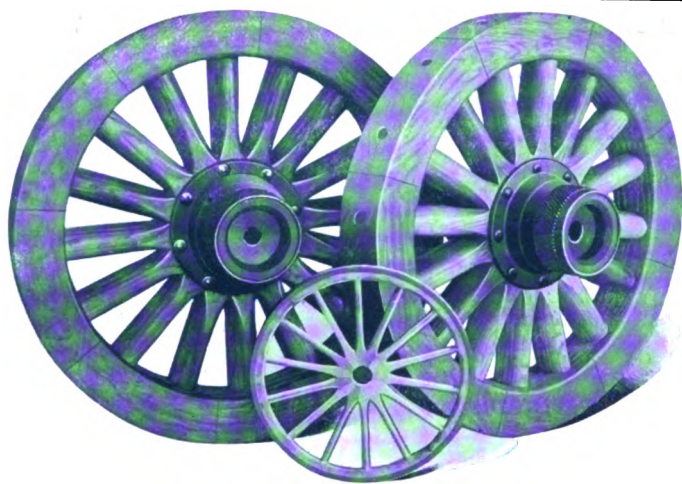

Standard Wheel Co.

Terre Haute, Ind.

Manufacture all kinds and all sizes of Wheels for Carriages, Wagons and Motor Vehicles

Quality First

THIS TRADE MARK MEANS MUCH TO VARNISH USERS



It signifies Quality. It is placed only on the best line of Varnishes we make---our Gold Cross Line. We stake our reputation on every drop that bears this brand. It implies Faultlessness, and has no superior from Japan to Finishing Varnish.

Rather strong language—but we can prove it; and we court comparisons. For years we have been making the most complete line of Carriage and Auto Varnishes and have put some very intensive study into the requirements of the trade. A test will convince you of the superiority of the Gold Cross Brand.

STEWART-MOWRY CO., CHICAGO, ILL.

Skewed Shaft Couplings

**Regular or Oval Patterns
For High Arched Axles**

Furnished in rights and lefts for any height of arch. Oval Axle Clips $\frac{5}{8}$ or $\frac{3}{4}$ width to match Oval Couplings. Bolts, Clips, Couplings, Carriage Hardware and Special Forgings

Catalogue "H" and Prices on Application

COLUMBUS BOLT WORKS, Columbus, O.

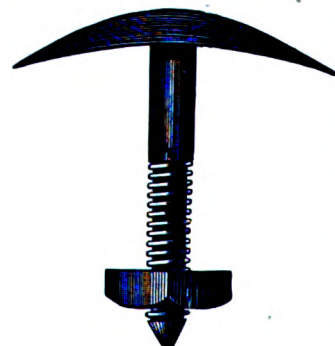
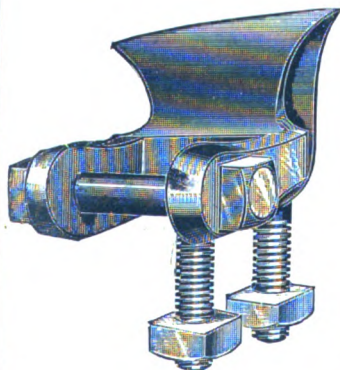

The Hub



TRADE NEWS PUBLISHING COMPANY
24-26 MURRAY ST. NEW YORK.

JOHN W. MASURY & SON

Originators of

Superfine Coach and Automobile Colors

ACKNOWLEDGED THE STANDARD FOR FIFTY YEARS

And Manufacturers of

Fine Carriage and Automobile Varnishes

New York

Chicago

Minneapolis

Kansas City

"BLACK VELVET" CUSHION SPRINGS

Manufactured Only by the

NATIONAL SPRING AND WIRE COMPANY
ALBION, MICH. WINDSOR, ONT.

THE SPRING OF QUALITY.



SPRING or SOFT EDGE CUSHION FRAME

For Buggies or Other Vehicles. Built of the Highest Grade of Steel Wire.

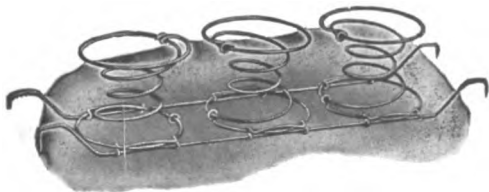

STRIP FOR WOOD OR BOX FRAME

THE F. H. LAWSON CO.

CINCINNATI, O.

Manufacturers of

Metal Buggy Seats

FLEUR DE LIS PATTERN

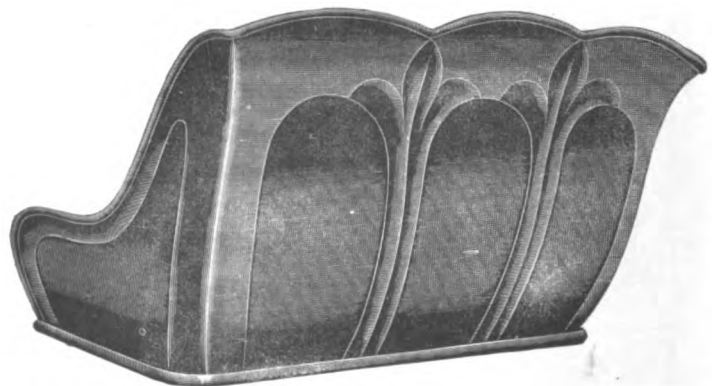

NEW STYLES—ALL SIZES

STRONGEST—NEATEST—BEST

No Solder Used

YOUR VEHICLE SELLS WHEN EQUIPPED WITH

LAWSON'S METAL SEATS

Write for Prices



SHERWIN-WILLIAMS VEHICLE FINISHES

A PRODUCT FOR EVERY PURPOSE, PRODUCING DISTINCTIVE RESULTS

S-W METAL PRIMERS S-W BODY AND GEAR UNDERCOATINGS

S-W Q. D. COLORS S-W COLOR VARNISHES

S-W FINISHING VARNISHES

EFFICIENT IN QUALITY AND UNIFORMITY

The SHERWIN-WILLIAMS Co.

CLEVELAND

CHICAGO

NEWARK

MONTREAL

LONDON, ENG.



WILCOX FINE FINISHED FORGED

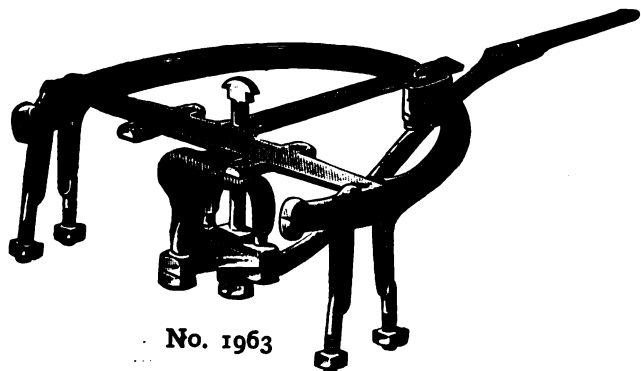

No. 1963

Carriage Hardware and Gear Irons

Write us for Catalogue No. 11B

The D. Wilcox Mfg. Co.

MECHANICSBURG,
CUMB. CO., PA.

Please mention "The Hub" when you write.

WILLEY'S COLORS

The **RECOGNIZED STANDARD**



C. A. WILLEY CO.

COLOR GRINDERS

and Manufacturers of Specialties in

CARRIAGE, AUTOMOBILE AND CAR

PAINTS

COLORS, VARNISHES, ETC.

HUNTER'S POINT, NEW YORK CITY

The WEST Hydraulic Tire Setter WILL CUT DOWN EXPENSE



Tires set cold in one minute. This machine saves time—does the work better and quicker, does a way with burned streaks. Only necessary to measure one wheel in a lot. Does not char the rim, and thus make the tire loosen prematurely.

Saves resandpapering of wheels. This machine is now increasing the profits of many manufacturers. Send for catalog and read about it.

WEST TIRE SETTER CO., ROCHESTER, NEW YORK

Established 1886

Correspondence School of Carriage and Motor Carriage Drafting

A thorough, practical tuition is given through this correspondence school. The theory and practice of construction, bookkeeping, perspective. Many men now hold good positions through taking the courses of instruction.

Principal, **THOS. MATTISON,**
Hillside Avenue, Bitterne Park,
Southampton, England

Author of "The Coach Body Makers' Guide," \$3.00; a practical treatise on "The Suspension of Carriages," "Bookkeeping," and other carriage building works.

WHAT IT IS

The American Harness and Saddlery Directory

The 1914 Edition

An extra painstaking revision of the names (and other information as below) constituting the Retail Harness Trade, has been completed for this year's issue of the Directory, and we think the work is so important and worthy that the

1914 Price Is \$5 Per Copy

and it is very moderate for what is offered in a work that is

Indispensable for Reference

for copying of addresses, and for all purposes usual in a directory.

Just a Sketch of Its Contents

The list of the **WHOLESALE** and **JOBGING TRADE** is so arranged as to make it convenient to separate the association members from those not so recognized.

The **RETAIL HARNESS MAKERS** of the United States and Canada comprise the principal part of the Directory, arranged by State, Town and County, and in the large cities, the street and number is given. Those rating (approximately) over \$1,000 are marked.

A list of **HARNESS DEALERS** as distinguished from retail harness manufacturers, is also given. The value of this list to those who solicit the vehicle, implement, hardware and department stores will be readily appreciated.

A list is also published of Export Commission Merchants, giving the class of merchandise they handle.

PUBLISHED BY

THE TRADE NEWS PUBLISHING COMPANY

PUBLISHERS OF "HARNESS"

24-26 MURRAY ST., NEW YORK

PORTER'S BOLT CLIPPERS
 "Easy" "New Easy" Allen-Randall



To Cut 5-16, 3-8, 1-2, 5-8, 3-4 Inch.

H. K. PORTER, EVERETT, MASS.

CARRIAGE—WAGON—AUTOMOBILE
 AND SPECIAL
DROP FORGINGS
 QUALITY—THE
 BEST

Richard Eccles Co., Auburn, N. Y.

PROMPT SERVICE.
 WRITE FOR CATALOG.
 SEND BLUE-PRINTS OR MODELS
 FOR OUR QUOTATIONS—IT WILL PAY YOU.



THE FAIRFIELD RUBBER COMPANY

Manufacturers of

**Carriage Cloth, Imitation Leather,
 Automobile Cloths, etc.**

FAIRFIELD, CONNECTICUT

KEYSTONE BLACK FILLER
 MAKES A PERFECT
ROUGHSTUFF
 For Automobile Bodies and Parts

It fills the pores of Metal and Wood perfectly. Sandpapers easily and produces a fine, smooth surface that DOES NOT CRACK, SCALE NOR PEEL.

POMEROY & FISCHER, New York
 Selling Agents to Vehicle Trade

KEYSTONE PAINT AND FILLER CO., Muncy, Pa.

Cargill Service

has brought to the Cargill Company more Vehicle Catalogues than are made by any other printing house in America.

Cargill Quality is bringing The Best Automobile Catalogues to our plant for Complete production—watch for our imprint in the Season's best books.

THE CARGILL COMPANY

DESIGNERS ENGRAVERS  PRINTERS & BINDERS

Grand Rapids, Michigan

Carriage Mechanics

Desiring to improve their present Condition should attend the

TECHNICAL SCHOOL

FOR

Carriage Draftsmen and Mechanics

SUPPORTED BY THE

Carriage Builders' National Ass'n

The object of the School is to teach men to design vehicles and make working drawings, and to otherwise facilitate their work in the shop. Only those men employed in carriage or automobile building or their accessory trades are admitted to its privileges.

The classes are conducted in three divisions, viz.: Corresponding, Day, and Evening. The former is open during the entire year, while the day and evening classes are in session only from October 1 to April 1.

The tuition is moderate.

For prospectus and full particulars, write to the instructor,
ANDREW F. JOHNSON,
 20 West Forty-fourth St.,
NEW YORK CITY

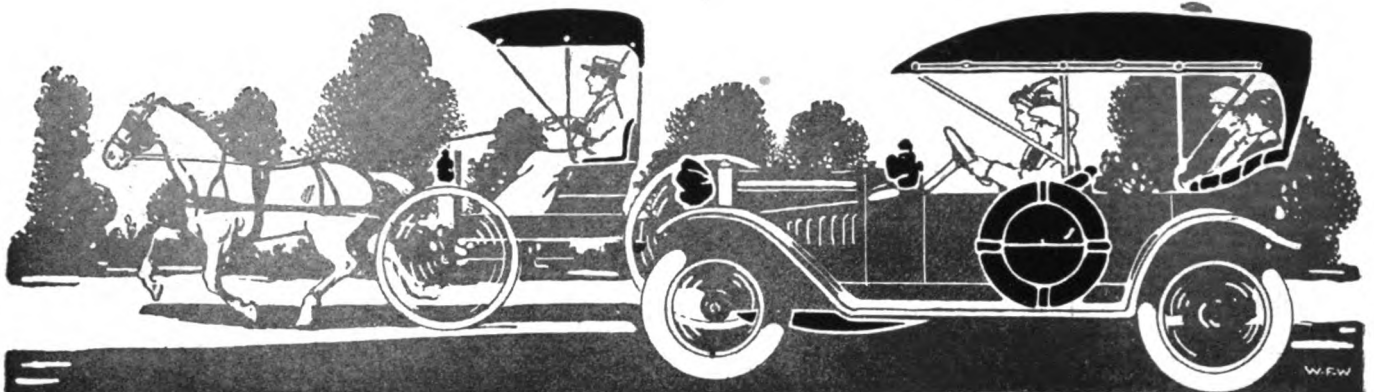

Learn More About The Leading Leather Substitute

Every carriage and automobile manufacturer—every manufacturer of carriage and auto accessories, storm curtains, aprons, lamp covers, tire cases, trunks, etc., should get and examine samples of

MERITAS

LEATHER CLOTH

Only by seeing the goods—by testing them—by noting the handsome, durable, non-cracking finish and the fine line of colors can you appreciate the high quality we have attained in the manufacture of a serviceable leather substitute.

There are styles, colors and finishes in MERITAS LEATHER CLOTH suitable for every carriage and auto trimming and upholstery purpose.

It can be had in muslin, duck and drill; dull or glazed; smooth or grained; in black and colors.

Sample book on request—write now and know more about the leading leather substitute.

Write
for
sample
book of
MERITAS
LEATHER CLOTH
NOW

The Standard Oil Cloth Co., Inc.

320 Broadway, New York

The

Hub

Copyright, 1914, by the Trade News Publishing Co., of New York

Entered in the New York Post Office as Second-class Matter

Vol. LVI

FEBRUARY, 1915

No. 11

THE TRADE NEWS PUBLISHING CO. OF N. Y. Publishers of THE HUB

J. H. WRIGHT, *President*

G. A. TANNER, *Secretary and Treasurer*

24-26 MURRAY STREET, NEW YORK

Other Publications of Trade News Publishing Co.:

HARNESS (monthly).....per year, \$1.00
AMERICAN HARNESS AND SADDLERY
DIRECTORY (annual).....per copy, \$5.00

THE HUB is published monthly in the interest of employers and workmen connected with the manufacture of Carriages, Wagons, Sleighs, Automobiles and the Accessory trades, and also in the interest of Dealers.

Subscription price for the United States, Mexico, Cuba, Porto Rico, Guam the Philippines, and the Hawaiian Islands, \$2.00, Canada, \$2.50, payable strictly in advance. Single copies, 25 cents. Remittances at risk of subscriber, unless by registered letter, or by draft, check, express or post-office order, payable to the order of THE TRADE NEWS PUBLISHING CO.

For advertising rates, apply to the Publishers. Advertisements must be acceptable in every respect. Copy for new advertisements must be received by the 25th of the preceding month, and requests to alter or discontinue advertisements must be received before the 12th day of the preceding month to insure attention in the following number. All communications must be accompanied by the full name and address of writer.

FOREIGN REPRESENTATIVES:

FRANCE—L. Dupont, publisher of *Le Guide des Carrossiers*, 78 Rue Boissiere, Paris. Subscription price, 15 francs, postpaid.

GERMANY—Gustave Miesen, Bohn a Rh. Subscription price, 12 marks, postpaid.

ENGLAND—Thomas Mattison, "Floriana," Hillside avenue, Bitterne Park, Southampton. Subscription price, 12 shillings, postpaid.

Entered in the New York Post Office as Second-class Matter

The Trade Figures.

The excess of exports over imports during December was \$131,863,000, a sum never before exceeded except in October, 1913, when the excess was \$138,912,000. For the year 1914 the excess of exports over imports was \$325,235,000, against an excess of \$691,421,000 in 1913, and \$581,144,000 in 1912.

Following the going into effect of the new and lower tariff in October, 1913, there was no immediate arrival of the flood of foreign goods as predicted. For several months exports were heavy and imports in little increased volume. But in March last imports so gained and exports so declined that there was practically no surplus of exports. In April imports exceeded exports, and so also in May, June, July, and August. Except for the war it is clear that 1914 as a whole would have seen an adverse balance of trade such as occurred under the Wilson tariff act. The contention of those who opposed the new tariff was in process of being vindicated by events when the war intervened. Politically the war was of great value

to the administration, for it diminished a foreign competition that was pressing more and more heavily.

Some political economists are able to demonstrate to their own satisfaction that a surplus of exports does not matter. It certainly does not matter to a creditor nation which has large investments beyond its own territory the charges of which are met with goods. But it apparently does matter to a debtor nation, like our own, which uses great supplies of foreign capital. The periods of adversity in this country have been those of relatively small exports, and conversely, prosperity has prevailed when the balance, to use the common phrase, has been in our favor. Whenever we are unable to meet a large financial balance against us by an excess of exports our domestic affairs have fallen into disarray.

The war is having the effect of greatly lessening the ownership of American securities abroad. How large is the volume of European selling and American buying no one knows, but the aggregate is huge. Probably at no time in our history was America so largely owned at home as now. Coincidentally there has been no small amount of lending abroad—to Argentina, to Russia, to Sweden, and to France. We have sold merchandise and taken evidences of indebtedness in return on which interest will annually accrue. The United States is becoming in an international sense a capitalist country. If the war lasts as long as some predict the old financial dependence will be gone.

The war has established a protective barrier in favor of American manufacturers higher than that established by the McKinley or Dingley acts. But after the war, what then? Will the work of fabricating things now made here begin again in Europe? It is difficult to reach positive conclusions, but it is clear that the monthly trade figures should be examined by every intelligent person, and correcting action quickly follow should such an increase of imports and decline of exports occur as marked last spring and summer.

Country is on The Mend.

Nothing short of total blindness to trade conditions can excuse ignorance of the steady flow of an undercurrent of confidence and optimism in American business circles today. "Business is rotten" was the usual reply to an inquiry even as late as a month ago. It is quite different now. There are smiles in January where frowns were seen in December. Extraordinary though the fact may be, even the war has been set aside in the calculations of the average American in business, and worriment on the

score of the European upheaval is exceptional nowadays. Our products are in such demand, at unprecedented prices, that the principal thing to worry about is whether our supply is equal to the needs of the transatlantic nations.

Stocks have kept well above July 30 prices; railroad men feel better than they have for several year and the number of unemployed, though still large, is diminishing.

In sum and substance, the signs of the times are uniformly reassuring. Money is to be had at much lower rates than were in force last fall, and more and more of it is coming into circulation each week. It takes time to recover from a solar plexus blow such as Europe delivered to the world last August, but America is demonstrating once more its splendid recuperative powers. The country is emphatically "on the mend."

Brandeis' Minimum Wage Scale

Brandeis' brief in the U. S. Supreme court supporting the validity of the Oregon minimum wage law consists of 398 printed pages. Only seven pages are devoted to discussing points of law and citing legal precedents, evidently because the law points are scarce and the precedents scarcer. The rest of the book is devoted to presenting the history of the movement for a legal minimum wage and the conditions which, according to Brandeis, prove the necessity for such legislation.

New Zealand was the minimum wage pioneer, enacting the first minimum-wage law in 1894. Great Britain's first law was enacted in 1909, in this country Massachusetts led the way in 1912. In 1913 Oregon, California, Colorado, Minnesota, Nebraska, Utah, Washington and Wisconsin passed such laws. This Brandeis book or brief is a storehouse of information on the subject. While Brandeis' name appears first, his co-author is a woman, Josephine Goldmark of the National Consumers' league.

Needless Waste

Fire losses in the United States and Canada during 1914 totalled \$235,591,351, according to figures given by the New York Journal of Commerce. With three exceptions this is the largest aggregate loss for twelve months recorded in thirty-eight years. The figures are nearly \$11,000,000 higher than those for 1913—but include the big fire at Salem, Mass., where the loss was \$13,000,000.

When we remember that from 70 to 80 per cent. of destructive fires in this country are due to carelessness and lack of precautions and penalties, when we realize that the per capita loss from fire in the United States exceeds that in leading European countries by from five to six times, it becomes plain that this nation is still strangely, recklessly indifferent toward civilized means of fire prevention.

Our apparatus for putting out fires is increasingly elaborate and costly. Our laws looking to the prevention of fires are as few and primitive as ever. When shall we get abreast of other nations by going to the root of the matter? In eight cases out of ten a fire is not merely a misfortune. It is somebody's crime?

VEHICLE WARRANTY

We warrant each new vehicle manufactured by us, to be as represented when used as a private vehicle, to be free from defect in material and workmanship under normal use and service, our obligation under this warranty being limited to making good at our factory any part or parts thereof which shall within one year from date of sale, by whom be returned to us with transportation charges prepaid, and which our examination shall disclose to our satisfaction to have been thus defective; this warranty being expressly in lieu of all other warrants expressed or implied and of all other obligations or liabilities on our part, and we neither assume nor authorize any other person to assume for us any other liability in connection with the sale of our vehicles.

This warranty applied to wheels only when the owner keeps the tires tight; nor do we warrant rubber-tired wheels against taking on excessive dish.

Nothing in this warranty shall render us liable to make good any damage to paint or varnish resulting from the action of ammonia or extraordinary exposure to the elements.

We will not be responsible for any repair bills unless authorized by us in writing.

In consideration of this warranty the purchaser agrees to give the vehicle fair use and reasonable care, and to make no claims for replacements resulting from accident, negligence or abuse; or in case he shall fail to keep his part of his purchase agreement. He also agrees to report to selling agent claims for defects within thirty days of discovery.

Vehicle Warranty Recommended by Joint Committee Representing the Carriage Builders' National Association and the National Federation of Implement and Vehicle Dealers' Associations, at Conference held in Kansas City, Mo., January 13, 1915

HERCULES PLANT TO GO ON FULL TIME

The Hercules Buggy Company, Evansville, Ind., announced recently that by the opening of March the full force of the employees in the buggy plant would be put to work and that it would run at full capacity thereafter. At present the plant, while not running at full capacity, is turning out from 250 to 300 vehicles a day and employing 1,200 people.

BIG JUMP IN TRUCK EXPORTS

In December last the value of motor trucks exported from the United States was more than double the total value of all such trucks exported in the whole of the year 1913. The figures for last December, as reported by the Department of Commerce to the National Automobile Chamber of Commerce, are: 1,279 commercial automobiles, valued at \$3,387,729, as compared with 88, valued at \$100,660, exported in December, 1913, and 1,009 valued at \$1,686,807, exported in the twelve months of 1913.

Passenger cars exported last December numbered 1,297, worth \$998,698, bringing the total motor vehicle exports for the month to 2,576, valued at \$4,386,427, as compared with 2,389, worth \$2,152,144, in 1913, and 2,013, worth \$2,060,812 in 1912.

MEETING OF PATENT AND ENAMELED LEATHER MAUFACTURERS

James B. Reilly, Newark, N. J., secretary of the Patent and Enameled Leather Manufacturers' Association, sends us the following synopsis of the meeting held in Newark, N. J., January 5:

The publicity committee reported upon its work to date. Evidence was produced in the form of automobile advertising showing the tendency of some automobile manufacturers to lay particular emphasis upon the leather upholstery of the car.

In connection with the publicity work, a communication was read by the secretary from the National Association of Upholstered Furniture Manufacturers, outlining a resolution passed by its executive committee, in the interest of proper identification and standardization of all grades of upholstery leather, which was as follows:

"Resolved that the National Association of Upholstered Furniture Manufacturers, feeling that the whole industry could be put upon a higher plane by forcing laws compelling the proper marking of goods and condemning the improper marking of same, go on record as endorsing all efforts promoting truthful advertising.

"Be it further resolved that copies of these resolutions be sent to the secretary of the National Federation of Furniture Manufacturers, to each secretary of the affiliated associations of said organization, also a copy to the National Association of Ad Men, and to the Patent and Enameled Leather Association."

The publicity committee was instructed and empowered to take up the matter as outlined in the above resolution, with the National Association of Upholstered Furniture Manufacturers, and to co-operate with that association to the fullest extent, in the efforts now being made to secure suitable remedial legislation effecting proper identification and standardization of all grades of upholstery leather, and the matter of truthful advertising pertaining to leather.

After full discussion and consideration of the question of classification of upholstery leather, the following resolution, upon motion regularly moved and duly seconded, was unanimously carried:

"Resolved, that all grades of furniture upholstery leather be hereafter classified and designated as (a) grain, and (b) split. Grain classification shall consist of "full" grain and "hand buff" grain, and "machine buff" grain, split classification shall consist of all grades of leather not containing grain substance."

In a letter to The Spokesman relative to the meeting, Mr. Reilly says:

The meeting was well attended and in the absence of President James F. Taylor, Harry N. Hill, of the Cleveland Tanning Co., acted as chairman.

Upon invitation received from the Second National Foreign Trade Council, Messrs. Taylor and Hill were appointed as delegates to represent this association at the National Foreign Trade Council convention to be held in St. Louis, January 21 and 22.

After the meeting, most of the members visited the New York Automobile Show, where an exhibit of genuine leather was on display, under the auspices of this association. The object of this exhibit is to counteract the effects of fraudulent and misleading advertising pertaining to upholstery leather, and the misbranding of leather substitute.

Up until yesterday we recorded forty-five complaints at the exhibit, from people who declared that they had been imposed upon in the purchase of upholstered furniture and automobile bodies, having been led to believe that the upholstering was of leather, and discovering later on, after a few months wear, that the upholstering was not leather as they had supposed, but was a cotton fabric with an imitation leather finish, sold under the guise of leather. Judging from this one may readily understand why manufacturers of upholstery leather seek to eradicate the evils, which militate against the best interests of their

industry.

The officers of the Association are as follows:

President—James F. Taylor, American Oak Leather Co., Cincinnati, Ohio.

First Vice-President—H. B. Good, R. C. & H. B. Good, Newark, N. J.

Second Vice-President—William Hatton, Ottawa Leather Co., Grand Haven, Mich.

Treasurer—Charles Grubstein, American Leather Manufacturing Co., Newark, N. J.

Secretary—James B. Reilly, Essex Building, Newark, N. J.

Board of Directors—Harry N. Hill, Chairman Cleveland Tanning Co., Cleveland, Ohio; M. F. McLaughlin, Kelly & McLaughlin, Newark, N. J.; J. Henry Smith, T. P. Powell & Co., Newark, N. J.; Max Hertz, Max Hertz, Newark, N. J.; James T. Smith, Hugh Smith Co., Newark, N. J.; Uzal T. Hayes, Howell-Hinchman Co., Middletown, N. Y.

Executive Committee—H. F. McLaughlin, Chairman; Max Hertz, J. Henry Smith, Harry N. Hill and James T. Smith.

Membership Committee—Robert C. Good, Chairman, Lackawanna Leather Co., Hackettstown, N. J.; Harry Stengel, George Stengel, Inc., Newark, N. J.; Charles L. Whitney, Conneaut Leather Co., Conneaut, Ohio.

An exhibit of Automobile Upholstery Leather, under the direction of the association, was held at the New York Automobile Show, Grand Central Palace, New York City, January 2-9, 1915.

5,510 MOTOR TRUCKS SOLD IN U. S. FOR WAR

By John R. Eustis

American motor trucks numbering about 5,510 and valued at \$16,119,000, have been sold for export to European governments since September 1. I am well aware that these figures are more conservative than some of the estimates which have been made recently, but I am convinced they are approximately correct.

Orders are being placed every few days, and new ones are expected to continue until the war is over. This country's total motor truck exports in 1913 were only 784 vehicles. The usual selling and maintenance expenses, averaging at least \$150 per truck, are saved to the trade and added to the profit on this export business.

The utmost secrecy has been maintained in the placing of these big export orders and the shipping of the motor trucks. Most of the orders have been given by individuals and local firms, and the payments made by various banks. Substantial deposits are made when the orders are placed and the balance of the purchase price paid when the vehicles are delivered in New York or at other shipping points. Deliveries on orders already placed will continue until next spring.

The largest buyers have been commissioners representing the French government. Their orders total about 2,640 motor trucks. The firm of Gaston, Williams & Wigmore has bought about 2,000. It has been rumored that many of these are for the Russian government. The Canadian and British governments have made small purchases. About 100 were bought for Greece, while 300 American motor vehicles were purchased by the Belgian government and taken from stock on hand at a London branch.

Motor vehicles are being used in the war for a wide variety of purposes. Their work has been so highly successful that they are considered indispensable. The severe service to which they are subjected and the artillery fire of the enemy disables them in large numbers. This calls for supplies of new motor vehicles, which in part must be met by importations of the American product.

The American motor trucks bought for the war range in capacity from one and a half to five tons in useful load capacity. Those purchased at first were mostly under three tons, but the orders placed in the last month have specified many five tonners.

This is much heavier than the foreign military authorities prefer, but it has apparently been a case of taking whatever could be had for prompt delivery.

Some of the makers have taken orders several times larger than their output for 1913. Nearly all the plants are working night and day, with two and even three shifts of men, and domestic business will be well cared for.

The following table giving the makes, numbers and value of the American motor vehicles bought by or for European governments since September, has been prepared after a careful investigation. The fact that all the principals concerned are pledged to secrecy makes it difficult to secure an accurate estimate:

Make	Number	Approximate Value
White	1,600	\$5,120,000
Peerless	1,000	2,500,000
Packard	800	2,750,000
Pierce	600	2,250,000
Kelly-Springfield	340	850,000
Jefferey	300	770,000
Overland	300	350,000
Federal	175	437,000
Garford	142	300,000
Kissel	100	300,000
Standard	100	320,000
Chase	50	160,000
Knox-Tractor	3	12,000
Total	5,510	\$16,119,000

IMPROVING CONDITIONS IN EXPORT OF MANUFACTURES

December, 1914, exports of manufactures regained the level shown by December of the preceding year, a decrease of 10 per cent. in finished manufactures being more than offset by the gains in manufactured foodstuffs.

In certain lines of manufactures, however, the exports during December, 1914, show phenomenal gains over those of December a year earlier, as, for example, in commercial automobiles, the value of which advanced from 101 thousand to 3½ million dollars; cotton knit goods, from 295 thousand to over 2 million dollars; woolen clothing, from 183 thousand to 1 1-3 million; other woolen goods, including blankets, from 103 thousand to 2¾ million dollars, and rubber boots and shoes from 84 thousand to 864 thousand dollars.

Leather goods also made a marked advance, sole leather exports increasing from 354 thousand dollars in December, 1913, to 3 3-5 million dollars in December of last year; upper leather, from 1¾ million dollars to over 3 million; and boots and shoes from 1,254 thousand to 1,288 thousand dollars, while harness and saddles exports increased from 43 thousand to 1½ million dollars.

Zinc continues the large export movement which began during the fall of 1914. During December 36 2-3 million pounds were exported, as against only 137 thousand pounds in December a year ago. Metal-working machinery nearly doubled in value of exports—from 1,350 thousand dollars in December, 1913, to 2,432 thousand in December of last year—wire increased from 781 thousand to 951 thousand dollars; bars or rods of steel from 777 thousand to 1,018 thousand dollars; and horseshoes from a quarter of a million to 3¾ million pounds.

Europe is taking an unusually large proportion of the manufactures now being exported from the United States. Of the 4 1-3 million dollars worth of automobiles, including both passenger and commercial vehicles, exports during December, 1914, 2½ million dollars' worth went to France and one million dollars' worth to the United Kingdom. Those two countries also took practically all of the metal-working machinery and England a preponderating proportion of the sole leather exported. England and France were the chief destinations of woolen clothing, blankets, and other manufactures exported during the month to the value of over 4 million dollars.

WILL MANUFACTURE MIDGLEY NON-SKID TIRES

Last spring Pittsburgh capitalists bought the plant of the Ohio Flint Glass Company, at Lancaster, Ohio, and since have been equipping it for the use of the Midgley Tire & Rubber Company, which is now manufacturing the Midgley non-skid tread tire. It employs about 400 men and has restored to the automobile trade a tire which was out of the market for several years, because of protracted patent litigation. About a year ago Harry X Davis, the well known theatrical manager of Pittsburgh, acquired valuable basic patent rights in connection with non-skid automobile tires and after extended litigation in the Federal courts won a sweeping victory and obtained a permanent injunction in the Court of Appeals, which sustained his patent rights and enjoined the manufacture, by anyone, of tires of this type.

For many years the Midgley tire was manufactured by the Hartford Rubber Works and was known over all the world. Its peculiarity consists of an ingenious imbedding of spiral steel wires in the tires which, in use, appear on the surface of the tire as a myriad of tiny steel projecting points which grip the road like the claws of a cat, making skidding, even on slippery asphalt, nearly impossible.

The name Midgley was given to this type of tire because it was first successfully made by Thomas Midgley, a veteran tire builder and president of the Hartford Rubber Works.

After obtaining the injunction and establishing his rights, Mr. Davis, and other capitalists, organized the Midgley Tire & Rubber Company and turned over to it the exclusive rights of the non-skid tire. Mr. Midgley, under whose personal supervision in the Hartford company, the Midgley tire was made, resigned his position as consulting engineer of the United States Tire Company, and became vice-president and general manager of the new company, under a long term contract. Mr. Davis is its president.

WILLYS SELLS GRAMM AND GARFORD INTERESTS

John N. Willys has withdrawn from the Gramm Motor Truck Co., of Lima, which he gained control of several years ago by purchasing more than \$500,000 of the \$750,000 common stock of the corporation. The capital of the company is \$1,250,000. Willys interests have also been disposed of in the Garford Motor Truck Company, Elyria, Ohio, and the Gramm and Garford agencies in Boston, New York and Philadelphia.

The Geiger-Jones Company, of Canton, widely known as industrial bankers, will be the dominant factor in the reorganization of the company. The banking company has acquired from Mr. Willys all of his interests and a meeting was held with the Lima stockholders consisting of D. C. Dunn, Henry Deisel, Sr., E. A. Macbeth, Henry Freuh, B. A. Gramm, J. E. Morris, D. W. Morris, D. F. O'Connor, F. X. Seiber, C. L. Wall, C. W. Werst, Jonas Wohlgemuth and P. A. Kahle.

E. A. Williams, Jr., formerly in charge of the Lima plant for the Willys-Overland Co., will be president and general manager. The Gramm company will make and sell Gramm and Garford trucks at Lima.

MOTZ BECOMES DEPARTMENT OF THE GOODYEAR

The business of the Motz Tire & Rubber Co., of Akron, Ohio, 50 per cent. of whose stock is owned by the Goodyear Tire & Rubber Co., will, after February 1, be conducted as a department of the latter concern. The Motz Company was incorporated in April, 1905, with a capital stock of \$50,000.

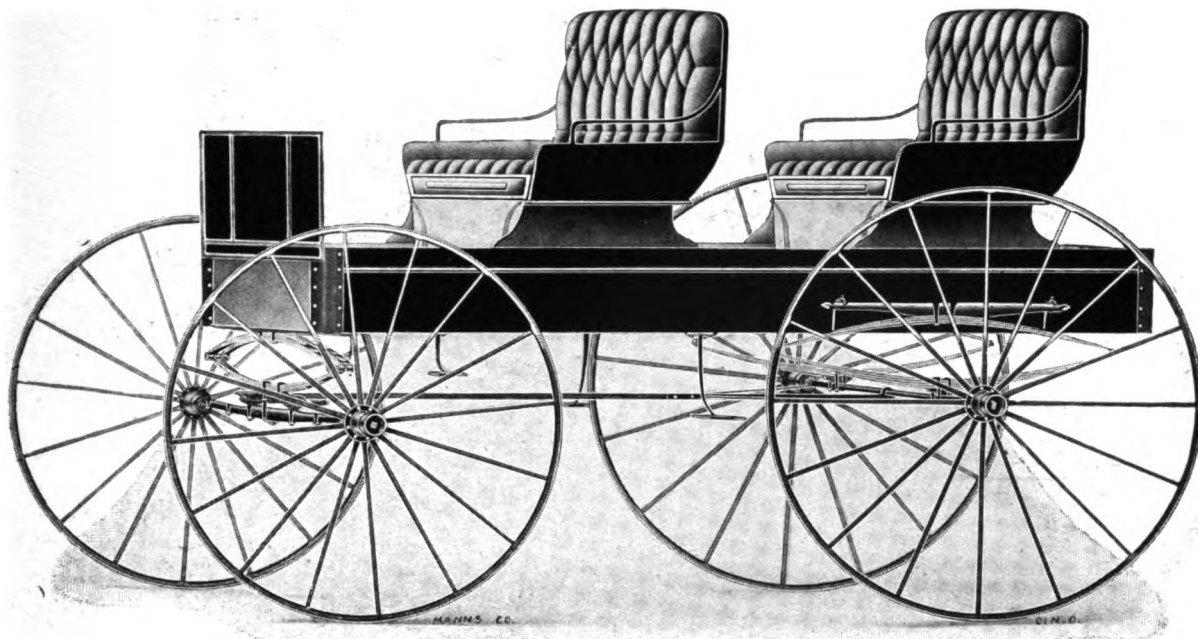

HEAVY SPRING WAGON
Built by Luth Carriage Co., Cincinnati, Ohio

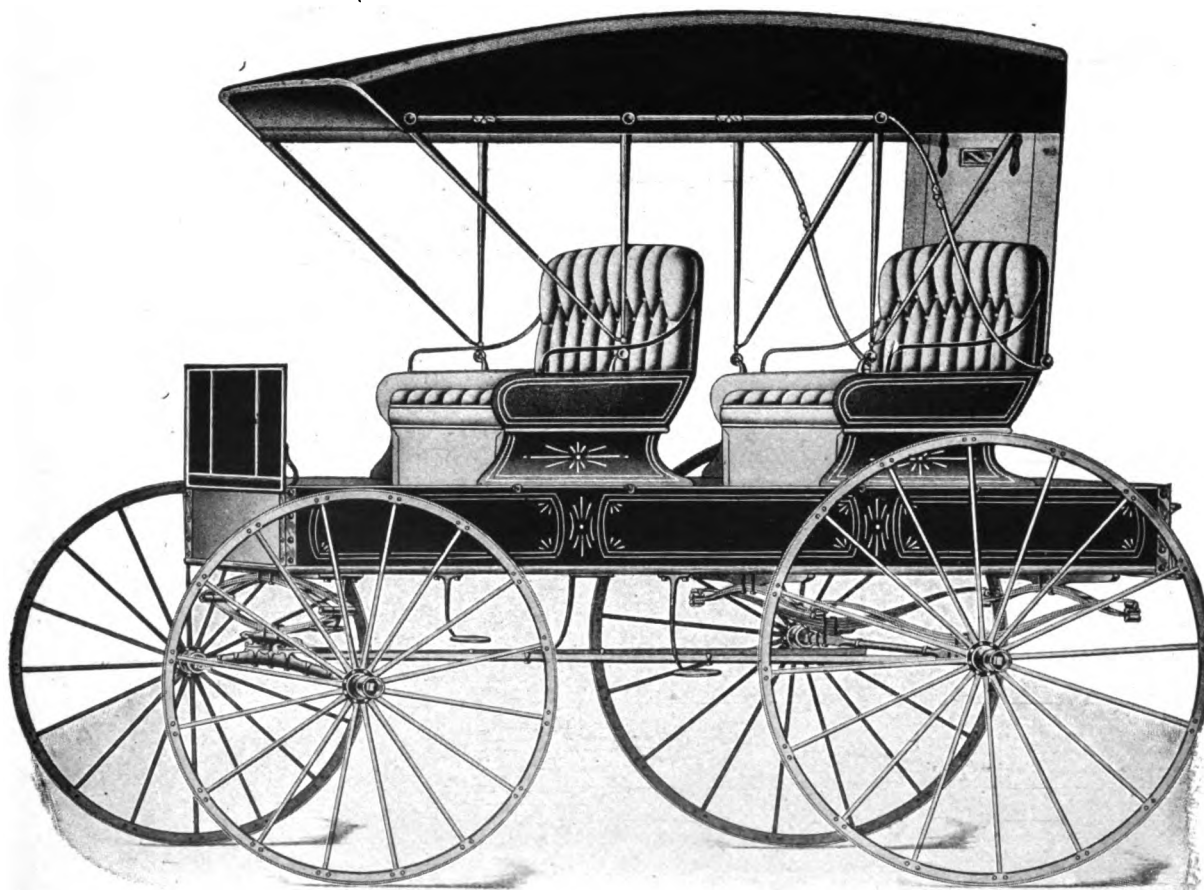

EXTENSION TOP PLATFORM SPRING WAGON
Built by Rex Buggy Co., Connersville, Ind.

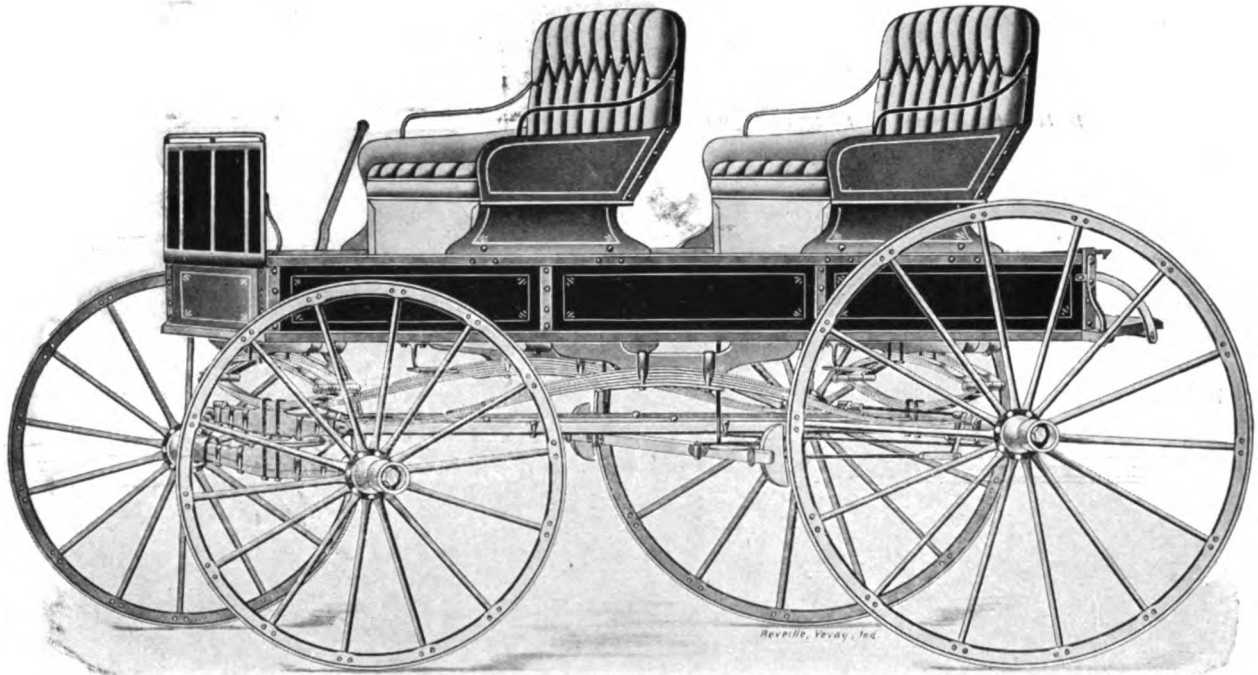

MOUNTAIN WAGON
Built by Rex Buggy Co., Connerville, Ind.

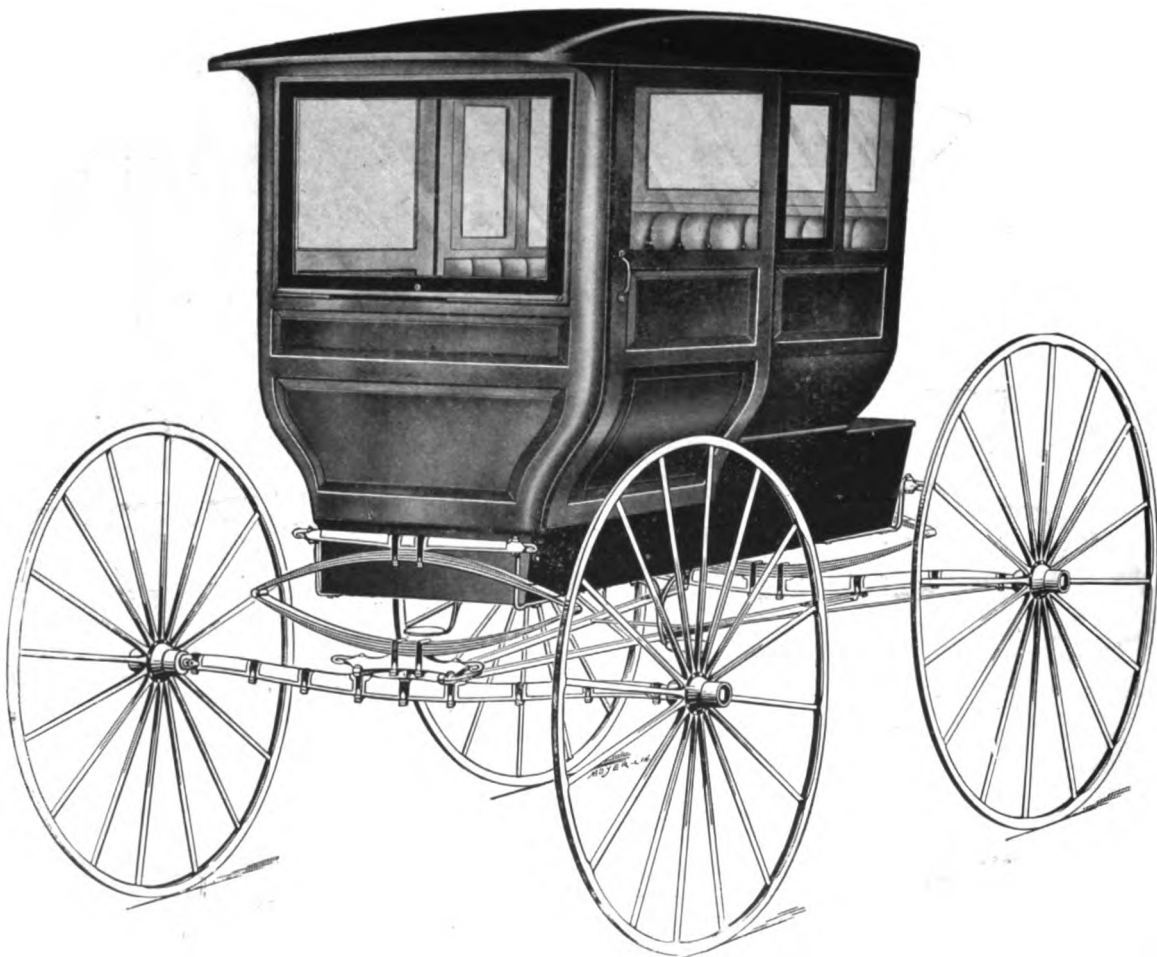

STORM PROOF BUGGY
Built by Parry Mfg. Co., Indianapolis, Ind.

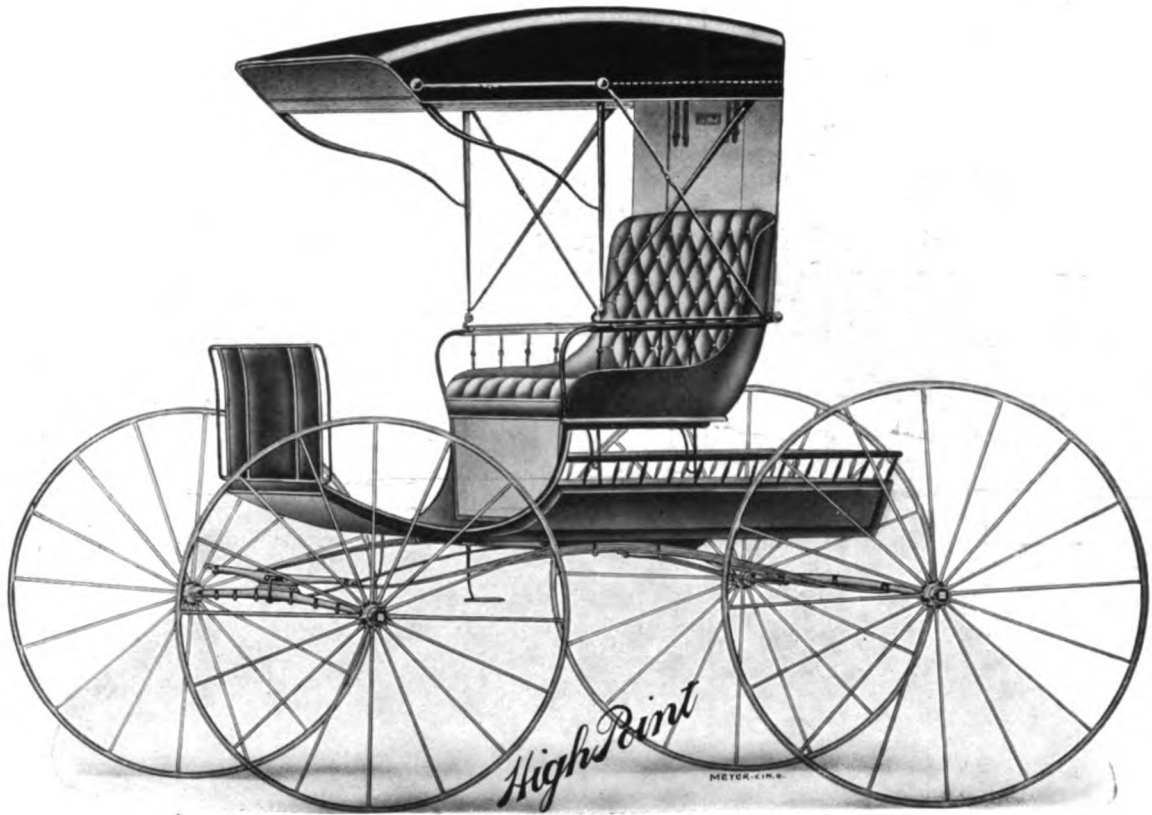

SPINDLE BODY TOP BUGGY
Built by High Point Buggy Co., High Point, N. C.

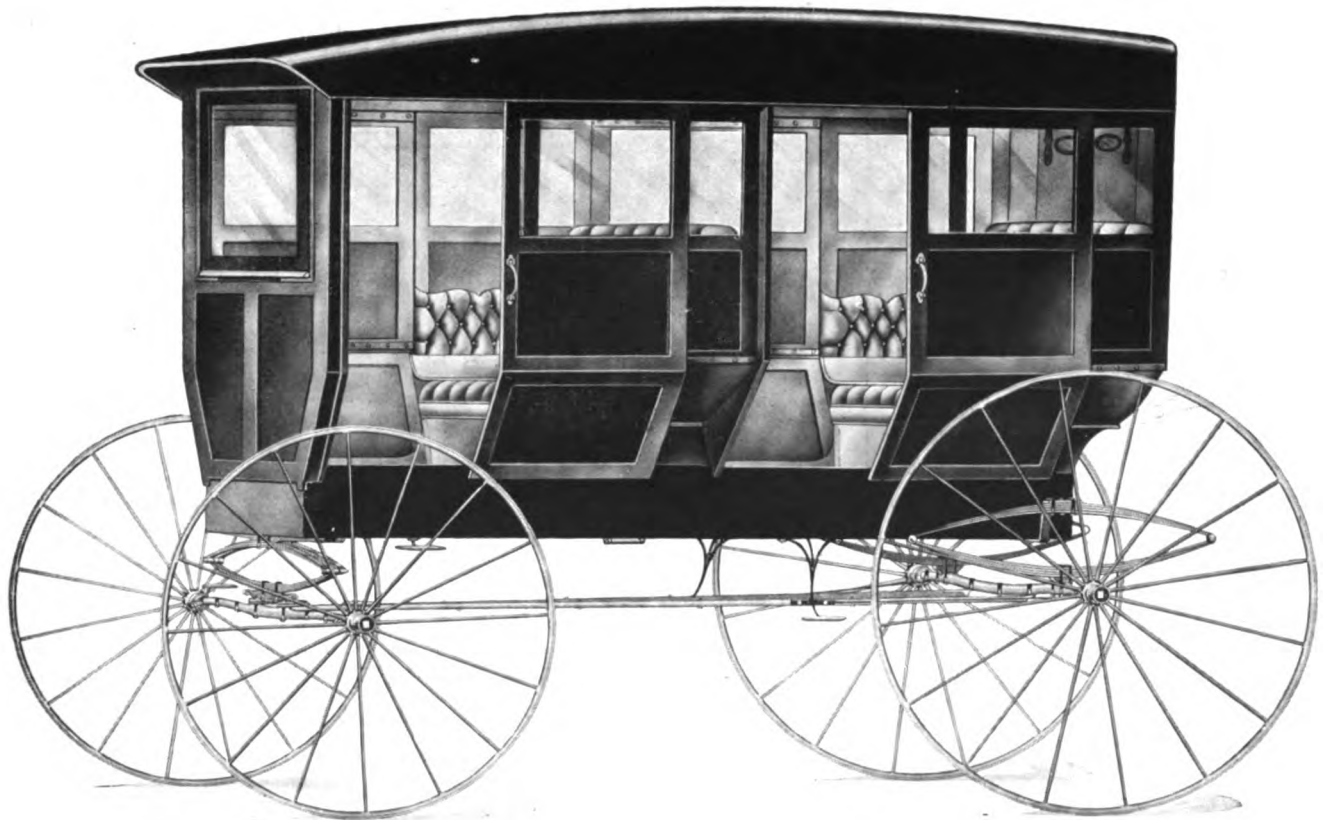

TWO-SEATED STORM-TOP SURREY
Built by James & Meyer Buggy Co., Lawrenceburg, Pa.

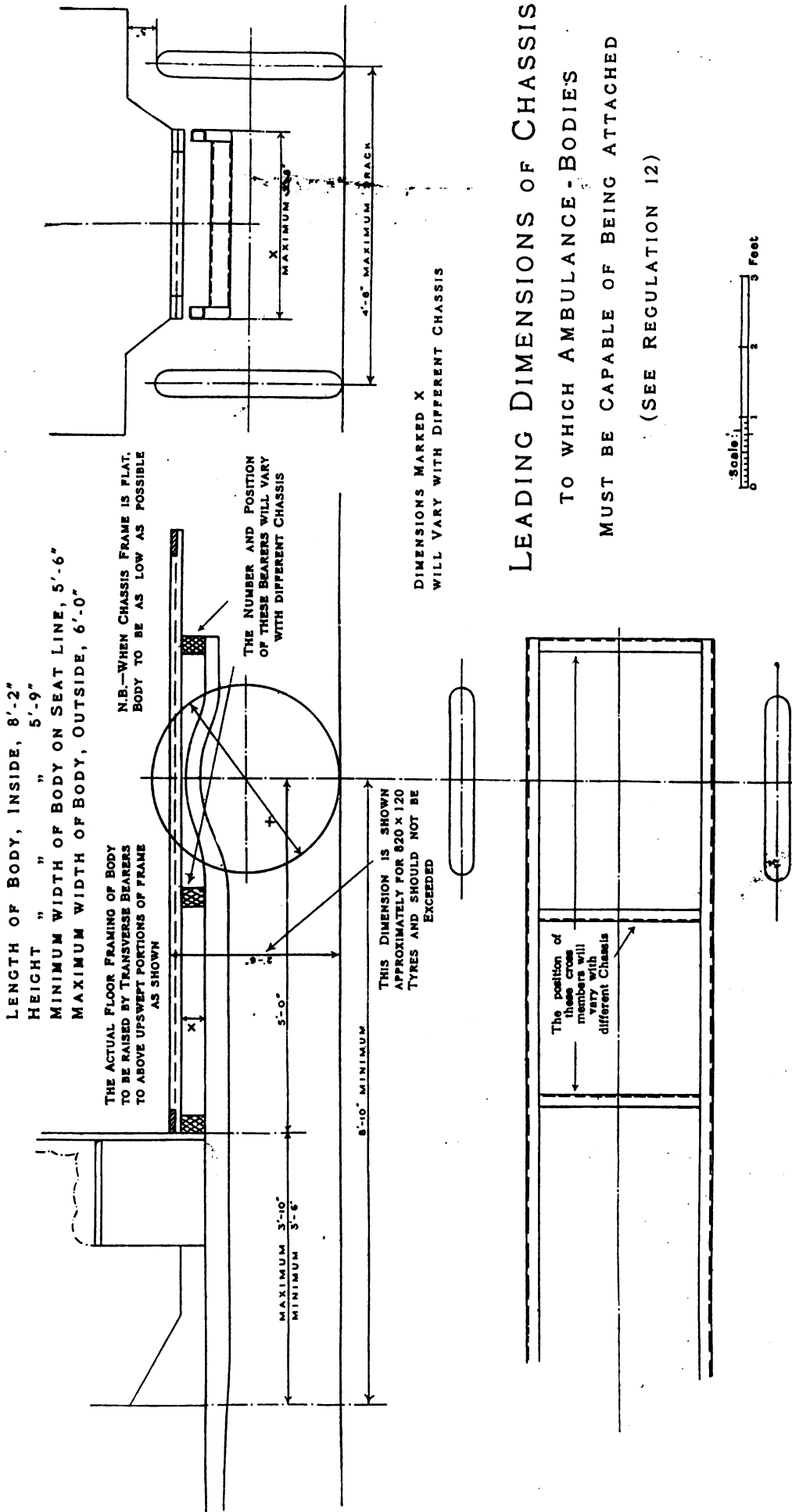

H. C. L. Holden Col.

PLAN GIVING PRINCIPAL MEASUREMENTS OF CHASSIS IN AMBULANCE DESIGN CONTEST
See Article on Opposite Page

Prizes for Best Designs of Ambulance Body

The present war in Europe is the first great war in which motor-ambulances have been extensively used. It was inevitable that many defects should be found in existing types, and in various quarters experts began to ask whether something could not be done to standardize the patterns and to improve the type. At the instance of Mr. Henry S. Wellcome, the founder of the Wellcome Bureau of Scientific Research, a commission has been formed in London, England, and the names of members show at once that the matter is regarded as of first importance by those most intimately connected with the welfare of the wounded soldier.

Sir Frederick Treves, whose long experience and distinguished service specially fit him for the task, has consented to be the chairman. The Admiralty is represented by the Director-General of the Medical Department, R. N., while the Quartermaster-General to the forces and the Acting Director-General, Army Medical Service, represents the War Office. The British Red Cross Society is, of course, represented by Sir Frederick Treves, and the St. John Ambulance Association, by Sir Claude Macdonald and Sir John Furley. The remaining members are all experts. This commission will first and foremost act as a judging committee for the award of prizes of the value of £2,000 provided by the Wellcome Bureau of Scientific Research. These prizes are offered for the best designs of ambulance body which shall fit a standard pattern motor, chassis for field motor-ambulances. The last day for the receipt of competing designs is June 30, 1915. It is hoped that the competition will bring in a number of ingenious designs, from which the ideal field ambulance-body will be evolved.

It may be asked why the competition is restricted to designs for a body and not for the complete ambulance, including a chassis. The reason is that a chassis takes much longer to build than a body, and that, when war breaks out, it is impossible to get at short notice anything like a sufficient number of any one type of chassis. On the other hand, a standardized body to fit any chassis of approved dimensions can be constructed in numbers at comparatively short notice. And a perfected body is badly wanted to insure complete comfort for the wounded.

It is hoped that the information obtained by the competition, and in other ways, will be published in some permanent form, available for future reference. Probably in addition to one design of special excellence, there will be submitted various ingenious suggestions which may be incorporated in the pattern design approved by the commission. For these, a portion of the prize money has been set apart. The first prize is of one thousand pounds, the second of five hundred, and the third of three hundred pounds. All details of conditions may be obtained from the Secretary, the Ambulance Construction Commission, 10 Henrietta Street, Cavendish Square, London, W. The competition is open to citizens of all nations.

As this is the first occasion when motor ambulances have been used upon a large scale in war, it was inevitable that experience would show that they are capable of considerable improvement both from an engineering and a medical standpoint. Mr. Wellcome believes that, at a time like the present, men's minds are stimulated and alert, and that, therefore, it is more likely that valuable ideas and inventions will be forthcoming at this juncture than under normal conditions.

He is, therefore, desirous of giving those interested in ambulance construction, especially those possessing expert knowl-

edge of the subject, an opportunity of exercising their talent, so that information may be forthcoming which will be of service to humanity, and which, when turned to practical ends, will serve to mitigate the sufferings endured by the sick and wounded in time of war.

The control and distribution of the sum mentioned is in the hands of a responsible and representative body, termed "The Ambulance Construction Commission," appointed on behalf of the Wellcome Bureau of Scientific Research. The commission will collect, judge and report upon such plans, designs and ideas as may be submitted to it. Its functions will be of an international character, so that it may obtain information from all sources.

The commission meets at the Wellcome Bureau of Scientific Research, 10 Henrietta Street, Cavendish Square, W., London, England, whither all inquiries and all designs should be sent, addressed to the Secretary, Ambulance Construction Commission.

The sum of two thousand pounds will be divided into a first prize of £1,000, a second prize of £500, a third prize of £300, and the remaining £200 will be awarded in smaller sums.

The first, second and third prizes are for a complete design of an ambulance body, complying with the conditions hereinafter laid down. The Commission reserves the right to award the whole or any part of the remaining £200 for details, such as an ingenious method of springing, an invention which could be applied to any motor chassis, an ingenious method of storing arms and equipment, a novel system of lighting, mechanical devices for self-haulage, etc.

Conditions.

- (A) Relating to construction.
- (1) The body must carry, in comfort and safety, four wounded lying on stretchers of British Army regulation pattern,* or eight wounded sitting, or two lying and four sitting, in addition to the driver and orderly attendant.
- (2) The patients must be sheltered from weather and sun, with due regard to ventilation. The driver and orderly must be provided with adequate shelter.
- (3) The vehicle must be capable of being loaded from the ground level by four or fewer bearers.
- (4) Every patient must be accessible for attendance from one side without being shifted from his position.
- (5) There must be a vertical space of not less than two feet between the lower and upper tiers of patients.
- (6) There must be sufficient windows to insure ample light by day, and means of lighting the interior by night.
- (7) There must be means for the orderly, on the box or elsewhere, to see every patient during running.
- (8) There must be means of carrying the arms and equipment of the patients, some dressings, water, and small quantities of hot liquid in the vehicle.
- (9) A vertical line through the center of gravity of the body must fall between the axles, whether the body is laden or empty. The center of gravity of the body must be kept as low as possible.
- (10) The body must be kept as light as possible compatible with adequate strength.

*Dimensions: Canvas, 6 ft.; poles, 7 ft. 9 in.; width, 1 ft. 11 in.; height, 6 in.; weight, 30 lbs.

- (11) The materials of construction should be as non-inflammable as practicable. Competitors may be called upon to submit samples of materials of construction.
- (12) The body must be of such a design that it shall fit a chassis, the essential dimensions of which are shown in the accompanying drawing.
- (13) In making the award, the cost of construction of the body will be taken into consideration.

(B) Any number of different designs may be submitted by any one competitor.

(C) Designs may be submitted on any date up to and including June 30, 1915. No designs received after this date will be considered.

(D) All designs will become the property of the Commission, which will take steps to protect the patents. In connection with this condition, competitors should read what is written below under the heading "Ultimate Object of the Competition."

Competitors should register the package containing designs submitted. A letter of acknowledgement will be sent on receipt of each competing design. If this letter is not received after the lapse of a reasonable time, competitors should communicate with the Secretary.

Since the object of the Commission is to improve the existing types of ambulance bodies, and to produce, if possible, a standard pattern body of perfect design which shall fit standard chassis, all designs submitted by competitors will become the property of the Commission. Apart from the prizes there will be no payment made for designs, which the Commission may, if it approves of them, publish in some form or other. They can then be used in the cause of humanity. Arrangements will be made which will enable the Government and existing Ambulance Associations to test and at once utilize any idea or invention upon which the Commission may report favorably, and it is Mr. Wellcome's intention eventually to publish in a suitable and illustrated form, under the auspices of the Wellcome Bureau of Scientific Research, such material and information as the Commission may deem worthy of being preserved as a permanent record.

We give herewith the names of members of the Ambulance Construction Committee:

Ambulance Construction Commission

Sir Frederick Treves, Bart., G.C.V.O., C.B., F.R.C.S., Chairman, British Red Cross Society; Major-General Sir John Cowans, K.C.B., M.V.O., Quarter-Master-General to the Forces, (represented by Brigadier-General S. S. Long, C. B., and Colonel H. C. L. Holden, C.B.); Surgeon-General Sir Arthur May, K.C.B., Director-General, Medical Department, R.N., (represented by Deputy-Surgeon-General McNabb); Surgeon-General Sir Alfred Keogh, K.C.B., Acting Director-General, Army Medical Service, (represented by Lieutenant-Colonel H. E. R. James, C.B.); The Right Hon. Sir Claude Macdonald, P.C., G.C.M.G., K.C.B., St. John Ambulance Association; Sir John Furley, C.B., St. John Ambulance Association; The Right Hon. Lord Montagu of Beaulieu; Professor W. E. Dalby, M. A., F.R.S., M.Inst.C.E., M.I.Mech.E.; John Robertson, Esq.; Andrew Balfour, Esq., C.M.G., M.D., Hon. Secretary and Treasurer, Director-in-Chief Wellcome Bureau of Scientific Research; Hardness O'Grady, Esq., Secretary.

MILBURN WAGON COMPANY ELECTS OFFICERS

The only change in the board of directors of the Milburn Wagon Company, made at its annual meeting was the election of Otto Marx to the board in place of W. I. Grove. Officers re-elected are: President, H. W. Suydam; vice-president, Otto Marx; secretary, F. D. Suydam; treasurer, F. H. Dodge.

MOTOR TRUCKS HAVE DISPLACED LESS THAN TWO PER CENT. OF HORSES

It will surprise persons interested in the future of the horse as well as those whose interest lies with motor vehicles to learn, on the authority of E. S. Foljambe, editor of the Commercial Car Journal, that motor-driven vehicles have really displaced but one and five-tenths per cent. of horses in the transportation field. In a paper on the field for medium and small trucks, Mr. Foljambe says, in part:

Prior to the introduction of the parcel post the Interstate Commerce Commission compiled figures on merchandise transportation. From these Government figures it has been deduced that of the total volume of transportation in the United States, the steamships and railroads combined handle but 15 per cent., leaving the other 85 per cent. to be moved by horse and wagon or motor-driven vehicles. Yet during exactly the period representing the introduction and growth of power-driven vehicles, namely, from 1900 to 1910, the Government statistics show an increase of 8.6 per cent. in the number of horses in use on farms and 11.7 per cent. in mules and other draft animals, making a total of 24,000,000 in use on farms alone.

A realization of how little inroad the truck has already made is borne in upon us when we consider the following figures: From 1908 until the present time, inclusive, there has been produced in the United States approximately 180,000 commercial cars. Of these 100,000 to 120,000 are probably now in use. On an average, counting all sized vehicles, these do not displace more than three horses each, or a total number of horses displaced of not over 375,000. When this number is compared to the total number of horses and draft animals in use, 26,000,000, it is found that commercial cars have in reality displaced less than 1.5 per cent. and even taking into consideration the motor driven farm tractor, the possible field still not covered is fully 98 per cent.

For the purpose of distinction, Mr. Foljambe classes all motor haulage as either transfer or delivery, saying:

By transfer is meant the movement of maximum loads from one point directly to a destination without lessening the load, such as the transfer from farm or factories to railroads or steamships, from mine to smelter, from stores to distributing points, etc. This class of haulage has been developed by the large truck to a high state of efficiency, but the average of even this class of load has been shown to be in the neighborhood of but 4,500 pounds.

By delivery is meant distribution of goods to numerous consignees, in which case there is an ever-diminishing load upon the vehicle and almost at no time does it carry its maximum. This is the field for the medium and small sized truck and embraces from 75 to 80 per cent. by volume of all merchandise transportation.

Transfer includes the raw product, while delivery concerns itself usually with the finished product. The total tonnage handled is practically the same, but the volume is vastly greater, the finished product, as a rule, occupying many times the space of the raw material. This necessitates a large number of delivery vehicles of large volume but small load capacity, as compared to those required to handle the unfinished product.

In the light of these figures it is difficult to figure out how the business world would be able to do without the assistance of the horse even if it was deemed desirable to do so generally. It would require an increase in truck manufacturing so great as to be an utter impossibility for many years to come. On the other hand, the figures show that, without the advent of the motor trucks, horses would not have been able to take care of the transportation which employs horses and trucks unless there had been a large increase in horse-breeding operations.

Charles Timpe and Charles Frey have bought the business of the Vonderhaar Carriage Co., at West Point, Ia., and will handle automobiles, buggies and carriages.

EXPORTS AND FOREIGN CREDITS

How American Manufacturers May Accommodate Foreign Customers with Reasonable Safety

The following article written by V. Gonzales, foreign trade adviser of the National Association of Manufacturers, is of general interest to all manufacturers at this time:

One of the advantages that Europe had over the United States in selling goods in foreign markets was the long credit granted by European exporters to merchants all over the world, especially in Latin America.

It has often been stated that British, French and German exporters (manufacturers or commission merchants) would sell against acceptances or on open account for as long as six, nine or twelve months, while we insisted on selling at not more than ninety days, when not for cash in advance, or against delivery of shipping papers here, or at port of destination.

European manufacturers had what we did not have (nor have we now with the Federal Reserve Act in force) banks to discount (or advance money on) such long time paper. European banks would take 12 months' paper, provided they considered the drawer good and that the acceptor was more or less satisfactory. Our banks would take 90 days' paper and no more.

It is true that the banking laws did not permit American banks to do many things which might have helped to foster our foreign trade, and our banks had not enough money, however large their resources may seem, to take care even of our domestic trade, as is proved by the fact that they borrowed large amounts in Europe through the so-called financial bills.

Where Federal Reserve Act Comes In

Now the action of banks has been enlarged to a certain extent by the Federal Reserve Act, which permits them to establish foreign branches to accept drafts, etc. But drafts at more than 90 days are not permitted to be negotiated except for certain agricultural business at home, which does not apply in foreign trade. The reduction of bank reserves, as provided by the above mentioned Act, will, in banking parlance, "loosen" up, to a considerable extent, a good amount of money available for loans, and the rediscounting of drafts by the Federal Reserve banks will also provide more money.

As far as negotiating 90-day bills on foreign countries is concerned, there is enough money and adequate legal-provision for the purpose. It is now the province of our banks to decide whether they will negotiate such bills freely and to secure reliable direct or indirect connections abroad for promptly collecting them.

Long Credits May Be Detrimental

The world needs more credit today than it did before, and if we wish to maintain and improve our trade we must not enforce rigid conditions; if we do we shall not be able to sell.

Long credits have been instrumental in advancing trade enormously, because goods were produced, transported, sold, retailed and consumed on credit, greatly discounting the future. Not always have results been up to expectation and many failures have originated in mistaken prospectuses. Merchants given twelve months to pay would buy more than they needed, or than they could dispose of; and would find themselves with large stocks of unsold goods, often unmarketable and usually impaired in value. They would also invest money, that should have been applied to meeting commercial obligations, in enterprises foreign to their trade, such as land development and others. These investments also would usually be made partly on credit, and when the time to pay came the investors would find themselves loaded with other than stocks of goods of their

own trade, bills receivable and cash.

Of course, this has also helped local development and, when successful, merchants have added a side line of profit to their regular business.

Now that credit has practically collapsed and that we need to assist effectively in building it again we might just as well try to make it safer without depriving our customers of any facilities that reasonably may be given.

Actual money from without is not needed anywhere, as each country has been and is able to provide local credit for its domestic turnover. What is needed is goods for consumption on easy and reasonable terms of payment giving facilities for the carrying of stocks to supply public demand. Practically all material improvements are stopped in all countries, and while the war continues and the future is uncertain no new railways or other public works are needed nor is there any urgency to further develop land or industries in any place. Financial resources, where available, should be devoted to maintain trade. While the granting of banking and shipping facilities should be provided by bankers and ship owners, in co-operation with each other, manufacturers and exporters on their side should also co-operate by extending credit to their foreign buyers, assisting in this way to keep up the export trade of the country and their own business as well.

Time Credits Should Be Extended

Twelve months credit for merchandise is too long. No merchant needs that much time from the day he accepts a draft (a few days before he can actually receive the goods, after clearing them from the custom-house) to pay for them. He has, of course, to pay in cash the landing charges, customs duties and others, which do not exceed 30 per cent. on an average, and he can refund himself of this from the first sales, in case he is entitled to it. Within six months after the goods are in his possession he can have sold them all, or any part of them that are saleable.

Commercial common sense will advise anyone not to carry larger stocks than can be sold within this time. Wholesale merchants in almost every country sell on credit to retailers at time varying from 30 days to six months, but, as a rule, notes are signed for these purchases and these notes are discounted by local banks, thus actually providing the wholesalers with cash. The entire process can be turned over within six months.

Certain lines of goods, such as heavy machinery for agricultural or industrial plants, may require a longer credit if payable with crops; also pianos and other articles sold on the installment plan. But these are specialties which constitute a separate line of business. General merchandise does not require, on an average, more than six months, and we should try to establish, from the beginning, this limitation.

Granting Credit with Bank Co-operation

Granting credit today is granting more than was granted before, and it is only reasonable that if we extend our former limit of time (90 days) to six months, our customers should help us carry the burden.

We would suggest, say, 10 per cent. in cash against shipping papers and the balance in six equal monthly installments of 15 per cent. each. In this way the manufacturer would refund himself of the expenses of transportation and insurance, which he pays, as a rule, in advance for his customer, and would be relieved every month of a part of the burden. If the banks do

not discount paper for longer than 90 days they can advance (or loan) the full value, taking the drafts as collateral for collection for a time which will allow the three first drafts to be paid and proceeds remitted. This would take up 40 per cent. of the loan. The balance could be extended (or renewed) for a time, permitting the other four drafts to be paid and proceeds remitted. Another way would be for the bank to discount the first four drafts, taking the other three for collection, discounting them in turn when enough time has transpired as to make them run only for 90 days more.

The Federal Reserve Act can be amended permitting banks to buy six months' foreign commercial paper, which would be so much easier, but there is no certainty that Congress will do it, and we cannot wait until it is done.

For foreign merchants the splitting of payments is no inconvenience whatever. On the contrary, it would be a great relief as they could pay much easier in small installments without borrowing from the banks or depending on their willingness to loan them money or not, especially at this time when no one knows what is going to happen a few weeks later.

The matter of interest for the further extension of time is a matter of detail and can be taken care of in readjusting the trade discounts or otherwise.

We would not, however, advise establishing these terms, as a rule, for all, nor to advertise them in circulars, catalogues or other public mediums. Each case should be treated separately, conforming with what each customer needs, but trying to make the customer also carry a part of the burden.

How Interest Rates Affect Situation

It is well to keep in mind the fact that, in almost all other countries outside of Europe, in normal times, the current rates of interest are higher than the 6 per cent. considered standard in the United States in foreign business. Local rates being higher, encouragement for anticipating payments on foreign accounts would not be furnished by the interest charge of only 6 per cent. per annum. Almost every merchant borrows from his local bank to pay his obligations, either discounting notes of his customers or otherwise. He certainly will not borrow in order to meet his foreign obligations if he has to pay a higher rate than he can obtain by anticipating his payments. Although an obligation of a good and reliable customer is quite satisfactory, actual payment is much better.

Overdue accounts which earn only 6 per cent. will be looked upon with less concern if to meet them the debtor has to borrow money at a higher rate. Should the local and foreign rates be made the same, there would at the least be more probability of the account being settled without any delay.

We would advise making arrangements to allow on advance payments a discount equal to the local bank rate of interest, and to charge for overdue accounts at least the same rate or 1 per cent. higher than local banks charge for uncovered loans.

DIRECTORS PLEASSED WITH YEAR'S WORK

Despite adverse conditions that prevailed in the South, where is the company's principal market, it was reported at the annual meeting of the Kentucky Wagon Manufacturing Company, at Louisville, Jan. 27, that a small profit was shown in the wagon department. During the year overhead expenses had been reduced \$40,000, it was announced.

It was also reported that modern labor-saving machinery has been installed, concrete floors placed in the plant to supplant wooden floors and thoroughly modernizing the factory. It is announced that operating methods have been revolutionized; that the products of manufacture have been diversified, manure spreaders, fertilizers and limesowers being added and other lines in prospect; that the company's market has been broadened by advantageous selling arrangements in parts of the country heretofore not entered and that, finally, there is the promise of a gradual return to the normal volume of trade.

In an official statement following the meeting directors announced that they were "agreeably surprised at the result of the business of the company for the fiscal year just ended." Resolutions of confidence in R. V. Board were expressed and he was re-elected president, all other officers and directors being re-elected as follows:

Philip S. Tuley, vice-president; W. P. Greusling, treasurer and district sales manager; S. K. Miller, district sales manager; John J. Shelley, secretary; W. J. Colbourne, factory manager. The directors are Philip S. Tuley, James Glazebrook, B. Bernheim, John Marshall, W. O. Harris, Stuart E. Duncan, Louis H. Wymond, Logan C. Murray and R. V. Roach.

According to unofficial report, net losses of the company during the past year were but \$5,000, this due to the electric vehicle department. For several years past annual losses are said to have averaged more than \$90,000.

WILL BRING OUT EIGHT-CYLINDER CAR AT \$985

The Lewis Spring & Axle Co., Jackson, Mich., has just announced an eight-cylinder five-passenger car to sell at the record low figure for this type of machine of \$985, equipped. The car is known as the Holler eight, and special emphasis is placed upon the fact that it is not assembled but is manufactured complete in the Lewis factory.

Equipped with a 3 by 4¼ V-type motor with the two blocks of four cylinders set at 90 degrees to each other on an aluminum crankcase, the motor, in its general design, adheres to the recognized practice for engines of this class. Suspension is at three points. Specifications of the chassis include a cone clutch of 12-inch nominal diameter, three-speed gearset, combination motor-generator for cranking and lighting which is attached to the gear-box, floating rear axle with annular bearings, 40-inch cantilever rear springs, 112-inch wheelbase, standard tread (60-inch optional), and 32 by 3½ tires on demountable rims. The equipment is in accordance with present-day requirements.

The Lewis concern has been working on this car for about eight months, but has kept the fact a profound secret until the present time. Active manufacture and distribution of the Holler is to begin at once, the company expecting to turn out 3,000 in the next year.

COMMERCE COURT DISMISSES PETITION

The petition of Toledo, Ohio, wagon makers for readjustment of rates on horse-drawn farm vehicles, farm wagons, carts and dump wagons from Toledo to points throughout a large part of the middle West and the West was dismissed Feb. 6 by the Interstate Commerce Commission. The complaint was directed against the rates charged by fifty-six roads serving Illinois, Wisconsin, Minnesota and States west of the Mississippi alleged to be on a relatively higher basis than those from Chicago, Milwaukee, Racine and other cities. The commission held that in respect to traffic conditions Toledo was not similarly circumstanced and that the present rate adjustment was not unreasonable.

SMALL CAR FOR \$325

The S. R. K. Motor Co. has been organized at Detroit, Mich. to make the Strouse small cars. The capital stock of the new company will be \$100,000, none of which will be offered to the public. The incorporators are C. E. Strouse, designer of the car, who is a professor and M. A.; F. T. Ranney, a real estate dealer, and T. D. Knight, a wealthy retired Chicago lawyer. The Strouse car has a four-cylinder block Hermann motor, 2½ by 4, 100-inch wheelbase, tread either 42 or 55 inches, 28 by 3 inches front and rear tires, gearless transmission, and will sell for \$325 with the small tread and for \$350 with the standard tread.

Paint Shop

THE LAKES AND WINE COLORS

The above class of colors continue to be much sought for by a number of critical vehicle users, notwithstanding the fact that durability in these colors has long been a subject of dispute among trade experts, says The Decorator.

Some of the lakes are especially beautiful in the depth and richness of their colors, and they take kindly to striping effects. Nothing in the line of solid colors quite approaches them. Munich lake, carriage part lake, purple lake, Cramoisie lake, carmine lake, American crimson lake, Chatemuc lake, and the reigning favorite, maroon lake, serve a purpose in the color world which no other pigments can. Take the darker of these lakes, carriage part lake for example, and stripe with heavy lines of black; or, for a heavy gear, stripe with a $\frac{3}{8}$ -in. line of black and edge with a fine line of gold bronze and one obtains something at once striking and elegant. Or stripe with two round lines of black $\frac{3}{8}$ in. apart and cast a fine line of twentieth century red at the centre between.

Cramoisie and purple and Munich lake do not show quite strong enough effects under black lines, unless gold is used to edge, or split the lines, thus drawing out the contrast between colors; but these lakes look charming if striped with what is known as the graduated stripe, as for example, draw the first line with madder or eastern red, and the next line piping on to this toned down somewhat, thus continuing with lines sufficient to cover the desired width of stripe, the final line being but a shade or two lighter than the ground color itself. Chatemuc lake yields particularly fine color effects under this style of striping.

English crimson lake, brilliant scarlet lake, and brilliant lake show rich and rare color effects when striped with the graduated line. As a matter of fact, the graduated stripe would long since have come into more general use on lakes, wines and reds, but for the difficulty attendant upon the work and the extra expense involved.

The wine colors show especially handsome shades, as put forth during recent years by color manufacturers. There is a superfine lightwine color for one extreme and wine color, dark, for the other, and between are two or three beautiful shades of this color.

For business wagon running parts the medium wine color applies to excellent advantage. One sees this shade used extensively upon the running parts of fine apparatus wagons. It makes a wonderfully effective background for lavish gold leaf decoration.

For running parts, brilliant wine color applied over a ground of dark Indian red offers pretty effects when striped with $\frac{1}{8}$ -in. lines of black $\frac{1}{4}$ in. apart, with a hair line of gold running at the centre between. Or reversing this order, use a $\frac{1}{8}$ -in. line of black and run distance fine lines of gold $\frac{1}{4}$ in. from the black. To still further vary the striping use $\frac{1}{4}$ -in. line of black, and edge with fine lines of gold. This same shade of wine may be striped with double fine lines of primrose, yellow, or twentieth century yellow, and the effects are sure to excite compliments. Light wine colors invite black lines for striping. These colors always harmonize, and while the contrasts are modest, they are withal elegant.

Use for striping, three lines fine of black $\frac{1}{4}$ in. apart or two $\frac{1}{8}$ -in. lines of black $\frac{3}{8}$ in. apart, with a fine line of black at centre, between, or reversing this order, use $\frac{1}{8}$ -in. lines, with distance fine lines, all of black.

One may use black in a great variety of styles and in no wise depart from the laws of good taste.

Most of the lighter shades of wine color are effectively used

over dark Indian red grounds. This same red darkened with drop black makes a suitable ground for the darker shades of wine color. Indian red, a durable color in itself, yields a good strong ground for these somewhat shifty, and in a measure sensitive colors.

All lakes and wines are governed in point of durability, very largely by the nature of the ground color. The fading property of these colors is pronounced, and the painter's point of vantage is gained by using a foundation possessed of strongly developed power for counteracting the fading propensity. Indian red, and Indian red and black, carrying a stout binder of varnish, offer this sort of a foundation, granting, of course, that the foundation as a whole has been skilfully prepared. The lakes and wine colors are indispensable in carriage painting.

AUTOMOBILE PAINTING

Automobile finish ranks on the average a little lower than the best coach finish, and the renewals are far more frequent, by reason of the greater wear and tear which the surface has to withstand. In fact, the old laborious style of coach painting does not produce an ideal finish for motor cars, and a less costly, but tougher, finish has been evolved. Again, the number of light color paints used for motor car work has brought about many changes in the painting procedure, and we now find that enamel paints are rapidly superseding varnish as a finish for motor vehicles of all descriptions.

This brings the work within the possibility of the trained brush hand, especially when we deal only with re-painting jobs. He might possibly be below the required standard when dealing with filling up and surfacing, such as would be necessary on new work, but on re-paints it is usually only necessary to rub down the old surface and apply the new paint. A good brush hand has probably had more experience in spreading enamel paint than the average coach painter, and if he will only follow some of the latter's expedients in producing a clean finish, he would more than hold his own, says Charles E. Oliver in The Dectorator.

The use of enamel paints for this purpose is simplicity itself, the chief care being the choice of material. This is of the utmost importance, as the least tendency to brittleness on the part of the enamel or the undercoats, is liable to prove disastrous, on account of the excessive vibration to which the surface is subject. The enamel paint must be tough but elastic, a combination which is somewhat contradictory, and to be found in extremely few of the materials now on the market.

As to process, the following is probably the most simple, and has been adopted by many of the leading firms doing this class of work.

Altogether three coats are given after the rubbing down and touching up of the old surface is completed. Having settled upon the color desired, a sample is sent to the manufacturers of the enamel paint which it is decided to use, with an order for a sufficient quantity of undercoat and gloss finish to the selected color. For a large car this would mean a quarter gallon of each. By ordering the undercoating in this way you save the trouble of making up any paint at all for the job, and if you go to the right house, you get a superior material.

You first apply a coat of the undercoating all over, keeping it as fine as possible.

When this is dry, it is followed by a second coat of undercoating, to which has been added a liberal quantity of the finishing gloss.

This will dry to a semi-gloss, and when flatted down with

pumice powder, will present an ideal surface for the final coat of full gloss.

Space will not permit us to enter into all the details connected with the application of the finishing coat, upon which so much depends. Much has already been written on the subject, and I feel confident that any man who has been brought up in the trade, and is used to doing good work, can very soon master them, and turn out a job which will recommend many others.

BOOK-KEEPING IN THE PAINT SHOP

Some one has said that "book-keeping is the science of knowing where you are at." What proportion of the whole number of carriage painters engaged in conducting a painting business fully appreciate the value of this science? From a considerable experience gained in custom paint shops, we feel safe in saying that a startling per cent. of the number of painters doing business for themselves depend upon very carelessly and imperfectly kept accounts to outline their financial condition. A system of book-keeping that fails to accurately indicate and explain the financial features of a business is quite as worthless as no system at all. It furnishes the promoter thereof a false security, which eventually will prove disastrous. The carriage painter, who achieves the distinction of being a shop proprietor, swings his name on the outer wall, and reaches out after that elusive thing known as business, should first of all, open up a safe and reliable system of keeping accounts—a business-like system. A complete record of the business transactions done is just as necessary in the small and modest country shop as it is in the more pretentious city affair. Correctness, system, regularity of accounts, are foremost principles involved in book-keeping. The "single entry" form is well adapted to the requirements of the average carriage paint shop. In this form of book-keeping the day book plays an active part. Here is recorded a daily history in detail of the owners business transactions. All the items of business should be therein entered plainly and legibly. If the business has reached the dignity of supporting a force of several workmen, the time book deserves a place in the account system. The labor cost comprises about 75 per cent. of the total cost of vehicle painting. Hence, the accurately kept time book with its black and white proofs—legal proofs, if it please the reader—of the labor expended upon the different jobs as they progress through the various processes to a finish, has a well established value. By this book a daily analysis of each employes time can be presented, and the exact cost of the labor put upon a given job is at the command of the employer. Competition has so burdened the painting business that it is in the highest degree essential that one should know beyond dispute the cost item involved in doing every job turned out. This knowledge is afforded by the tidily kept time book.

The ledger enables one to accurately gauge his financial position at any time—to ascertain the debtor and creditor problem at a glance. When the journal is omitted from the system, detailed accounts must necessarily find a place in the ledger. Be that as it may, neatness and accuracy should mark the ledger work, as they are expected to mark the earlier stages of the account system, and finally, the painting business must be based upon a careful book-keeping system to be long maintained in a commercially prosperous condition.

SCROLLS AND CORNER PIECES

Many who are good strippers, both in fine and coarse lining, cannot design, or if they can they cannot arrive at the correct proportions, being lacking in quality and form. The lack of system and practice in ornamenting is sure to end in failure. All who are good strippers, mechanically, can cultivate capacity for form, proportion and comparison by having their work systematized. The result will pay for the effort. For instance, you learn to

guide the fingers by the taper of a spoke or whiffletree, but in ornamental striping, the hand must be guided by its impulse alone, and practice and taste co-operate. If the panels be black or wine colored, use green or white for corner pieces or center panel designs. The attractiveness of such designs depend greatly on the colors on which they are put and the colors of which they are composed.

EFFECT OF WAR ON BRUSH-MAKING INDUSTRY

The cost of bristles for brush making has by reason of the war increased about 35 per cent., and the wholesale prices of all qualities of brushes have increased at least 20 per cent. The better the quality of the brush the greater is the increase in cost of production.

The trade has been further embarrassed by an increase of 100 per cent. in the price of bass from Africa, used in making the cheaper brushes, while the wreck on the Norway coast of a vessel on its way to England, bringing some 70 or 80 casks of Siberian bristles, has further reduced the supply. This represented practically the year's supply of bristles shed in the spring from one large Siberian collection center.

The country now being fought over in Poland is one important source of supply, while the Leipzig Fair was the most important center for the sale of this raw material, so that source of supply is necessarily closed to the British market. Frankfurt on the Main was another center of supply, also now closed.

Bristles came also from India and China and France. The higher freight rates ruling for shipments from India and China have also had an appreciable effect on market conditions.

The diversion of the supply to America has been another impediment to the British market. It is anticipated that later in the year there will be a serious shortage which will be accentuated by British Government orders for brushes.

Again, timber for the manufacture of brush backs, which came in large quantities from Scandinavia, has advanced in price by one-third to one-half.

Hemp and twine used in the making of broom heads and painting brushes have also advanced. The small stocks in China and in India have caused advances, and the increased demand due to the shortage from Russia has had a further tendency to increase the cost of production.

FRENCH MARKET FOR PAINTS AND VARNISHES

Consul George A. Bucklin, Jr., Bordeaux, writes: Several inquiries from American paint and varnish manufacturers seeking a foreign market have recently been received here. Interviews with the managers of several large paint firms in this city indicate that there is no sales opening at present, because of the war. Merchants here continue overstocked with English paints and varnishes, of which no disposition can be made. Furthermore, ablebodied men, including house painters, are difficult to find.

There will, of course, be a change when hostilities cease, and two important local houses will be glad to receive price lists. (Addresses on application to the Bureau of Foreign and Domestic Commerce and its branches.)

When American price lists printed in English were presented to the managers of the Bordeaux houses regret was expressed that they were not printed in French with equivalents of weights and measures in the metric system. This is important.

According to the report of the Joint Congressional Committee on Federal Aid to Good Roads, the annual expenditures for road improvement in the United States amount to about \$204,000,000. Automobile license fees amount to about \$8,000,000 annually. County, township and district road bonds were voted in 1913 to the amount of \$50,635,000.

JANUARY MEETING OF THE CINCINNATI CARRIAGE MAKERS' CLUB

Perrin P. Hunter Pays Tribute to the Memory of Albert Hess

The Carriage Makers' Club of Cincinnati, held its January meeting at the Business Men's Club, January 21, there being present 43 members and four guests, First Vice-President Clen Perrine presiding. A communication was received from the Civic Council of Club Presidents, requesting the authorization by the club of the membership of the Club's president in its organization. The request was granted.

W. E. Wilkinson, Hancock, Md., requested the names of carriage and buggy manufacturers in Cincinnati, saying he had large orders to place shortly.

The transfers of membership of Walter Lang to E. E. Hess and of J. L. Adams to M. A. Williams, were both made without charge.

A. A. Nutter, of the Nutter Gearwood Co., Seymour, Ind., was elected to membership without initiation fee, as he was a former member of the club.

The resignation of Mr. Laidlaw was accepted.

A letter from President Brunsman from St. Louis, was read, expressing his regret at not being able to be present, and appointing the following nominating committee: James E. Taylor, H. M. Pollack, G. W. Huston, W. A. Sayers and F. C. H. Manns, also a committee consisting of O. E. Walker, Jason Schneider and Howard Cox, to draft suitable resolutions upon the death of Alfred Hess.

The following letter paying tribute to the high esteem in which Mr. Hess was held, was received from P. P. Hunter:

"To the Members of the Cincinnati Carriage Makers' Club:

"Our roll of membership and fellowship is one less than it was at our 'Christmas Dinner,' as we had with us a member who had been quite faithful in his attendance for more than a third of a century. No one was more pleased than I to see Mr. Alfred Hess gather with us for our 'Christmas Meeting'—Tuesday evening, seventeenth of December passed. No one was more stunned than I, to return to this city December 23, to learn that Mr. Alfred Hess had passed away Monday, December 21, 1914. In company with our president, I attended the funeral of Mr. Hess, at the family home, where so often in years gone by, I had richly enjoyed his cheerful home circle. The presentation of his Masonic Ring to his illustrious son, Elmer J. Hess, touched the hearts of the listeners, but it handed down to a younger member of the 'Ancient Order,' the insignia, the love and 'Royal Mark' of a good father and a loving husband, for his pleasure was in his home life. Born in New York State, married early in life, we hear of Mr. and Mrs. Hess, as pioneers, in the late fifties near Winona, Minn., when settlers lived fifteen to thirty miles apart. The close of the year found Mr. Hess at Jackson, Mich. After 1872 the family moved to Dayton, Ohio. In the meantime Mr. Hess was the traveling representative of the Sheldon Axle Co., of Auburn, N. Y., and spent the greater part of his time in Cincinnati, as this city had developed into the buggy center of this country. In 1879, Mr. Hess moved his family to Price Hill, Cincinnati. In 1880 Mr. Hess and close associates founded the Cincinnati Spring Co., the first industry of its kind in the west. This plant was sold in 1892 to the Columbia Spring Co. In 1893 Mr. Hess and son, Elmer J. Hess, bought the Union Axle Co., of Carthage, enlarging the plant wonderfully in the next few years, and this large industry is known as the Hess Spring & Axle Co. In recent years Mr. Hess had withdrawn from active business and was president of the First National Bank of Elmwood Place. Salesmanship was an easy art with him, as he had the confidence and friendship of our craft, and was instrumental in building two large plants in our midst.

True to Yankee spirit, he was frugal and thoughtful for the future of those he loved. It was his pleasure to build homes, and in recent years he built eight or ten near his place in Wyoming. In his early life he was a good farmer, in late years he enjoyed the garden and had abundant flowers.

All his life he loved horses, and was their friend, and until recent years was a constant driver of a matched pair. In the ups and downs of the Carthage industry, he had his share of burdens. It was my pleasure to spend a month with him in Washington, at the time the Maine was blown up in Havana Harbor. He was a lovable companion, and we have all lost a comrade who reached the four score mile post leaving behind a well spent life. I am pleased to subscribe myself as one of his friends and admirers.

PERRIN P. HUNTER.

The speaker of the evening was Mr. Carl De Honey, of the Trade Expansion Department of the Cincinnati Chamber of Commerce. His subject was "Cities." He analyzed the health, wealth and growth of conditions of Cincinnati, stating that the Chamber of Commerce was doing a good work just now, that the membership of that organization in 1900 was about 800, that in 1915 it was 2200, and that their greatest service right now was in re-building in all ways. The Chamber of Commerce has twelve departments with ten subsidiary organizations, working and helping to one end, namely to overcome the ultra, conservative spirit which had marked the affairs of Cincinnati in recent years. That many corrections, through an educational campaign was to bring about the many needed improvements, and the slogan to go out from Cincinnati right now is, that we are building a new city here, and that 1915 is to be an extremely busy year for the city's progress toward higher, better and larger ends, citing many instances, among others the \$14,000,000 suburban transportation project, closing with the following: "And remember that a city, like a stream can never rise higher than its source, and that a city will inevitably reflect the average of its citizenship."

ELEVENTH ANNUAL DINNER OF TECHNICAL SCHOOL ALUMNI

Many members of the Alumni Association of the Technical School for Carriage Draftsmen and Mechanics of New York participated at the eleventh annual reunion and dinner held at St. Denis Hotel, that city, on January 8.

Entreaties were made to make the dinner a speechless one by members who are not strong at oratory. It was unavailing, however, as the suppressed feeling of gratitude toward the school and its leading spirit had to be released, resulting in the utter defeat of the antis.

President Hamann, who presided, spoke of the accomplishments attained through a course at the school and of the value of attending annual reunions by keeping in close relationship with members of the graduating classes of various years.

Professor Johnson gave an interesting history of the school from the date of its organization and connection with the Metropolitan School of Art in 1882 and later as an independent institution under the auspices of the Carriage Builders National Association with class rooms at Broadway and Twenty-eighth Street and still later, its affiliation with the Young Men's Institute at 222 Bowery, from which place it withdrew to its present commodious quarters at the Mechanics Institute, 20 West Forty-fourth Street.

Others spoke in warm praise of the school and its work and the good it has sowed throughout this country and several foreign countries as well; some dispensed funny stories and witty sayings, together making it an evening spent to good advantage.

The Automobile shows attracted a number of out of town grads who enjoyed the feast and the company of old friends.

The officers elected for the ensuing year are: President, Carl Hamann; Vice-President, John S. Burdick; Historian, Andrew F. Johnson; Secretary-Treasurer, Jacob H. Klein.

IMPORTANT OFFICIAL CHANGES

At a meeting of the Board of Directors of the Murphy Varnish Co., at Newark, N. J., held on January 12, the office of Chairman of the Board was created and Franklin Murphy was chosen to fill that office. Franklin Murphy, Jr., was chosen to succeed his father as President of the company, and John J. Nicholson succeeds Franklin Murphy, Jr., as Vice-President. The office of second vice-president was abolished.

The retirement of Mr. Murphy from the active duties of president, to the less confining atmosphere of chairman of the board, carries out a purpose formed some time ago, partially at least, to retire upon the fiftieth anniversary of his service with the company. In his new position he will be a close advisor to

his successor, whose twenty years' experience in all departments of the business fully qualifies him for the responsibilities of the presidency of the company.

IT GREW FROM SOMETHING SMALL

The story of a simple design that grew into something useless and elaborate as the result of misguided but well-meant criticism, is told as follows, by a writer for an English publication:

In the beginning it was a simple, unassuming little cyclecar. It owed its existence to a number of enthusiastic sidecar owners, who found, for the most part, that heavy, twin sidecar outfits represented their ideal in all but two points. They failed woefully in weatherproof comfort, particularly for the rider, and they were not calculated to please the mechanically-minded, either in theory or appearance.

Therefore, a number of brainy enthusiasts put their heads together and decided to build a "sidecar" with four wheels, which should weigh no more, cost no more, be no more complicated than the three-wheeler. The result more than exceeded their expectations. After learning a few lessons from experience, they evolved a beautiful little vehicle. If it had four wheels instead of three, the weight was distributed so much more evenly, that tyres lasted infinitely longer, petrol consumption was no greater, belts were far more successful, and repairs were as simple to effect as on a heavy sidecar.

But this "sidecar on four wheels" was bound to invite comment. It did. It created a furor. People who saw it wanted one. And, of course, certain people criticised it. Its terrible shortcomings did not prevent its owners extracting enjoyment from it.

And then came friends, and from these the cyclecar was not safe. They were genuinely interested and thrilled by this product of the new motoring. A motorcar within their reach! But they wanted to be motorists and talk of "the car."

One would like to have a vehicle built like it but for the fact that he did not trust belt drive. He had driven a belt-driven sidecar and found it satisfactory, but did not think it would "do" on a cyclecar.

The next did not like air cooling. He had owned a heavy, air-cooled sidecar outfit, but this did not excuse air cooling on a cyclecar. So the cyclecar was water cooled to please him.

It was now a trifle heavier and more complicated than at first, and one of its first charms—flexible drive—had been lost. Also, it had now got a heavier rear axle and a differential, which were more expensive to build and more liable to trouble.

And then it was again altered. The next admirer liked it immensely, but thought how much sweeter a four-cylinder engine would be, and this, in turn, was carried out, with the result that it was certainly smoother in running, though it had lost the fascinating note of a well-tuned twin so dear to the enthusiast, and, also, it was getting expensive to run. This man used to drive a twin-cylinder engine.

The fourth person to have any say in its construction was a lady, who specified a heavy, luxurious body, with many special fittings, including a dynamo lighting set. And the excellent little engine felt the difference and lost its old liveliness.

The cyclecar was now no longer. It was a light car and a very excellent proposition still. It was a real car in miniature, and still had the peculiar fascination of neatness and handiness. But only those side-carists whose means were increasing had followed it thus far. Those who had looked on it as a substitute for their old sidecars and not a stage higher in the scale were now no longer interested.

And then came one who liked the light car as it stood, but felt that the "cyclecar" engine was now badly treated. A bit more reserve of power would make the difference. So an engine of 1400 c.c. was fitted, and again the light car became a thing of abundant life and stored energy.

It was allowed to remain thus for a while, and then attacked by three admirers and prospective purchasers simultaneously.

One said a longer wheelbase could be built just as lightly, and substituted 9 ft. for 7 ft. 6 in. The new wheelbase improved the steering very slightly, and also lessened road shocks; but after a while it was found that, in increasing the length, weight had been studied at the expense of strength and solidity, and that, strength for strength, the longer wheelbase was also the heavier. So once more the weight was increased.

Then it was pointed out that a wider track made for greater stability and comfort, and again weight was increased. Larger wheels were advocated for the better comfort of passengers, and the new set of tyres cost just about double the first lot.

The man who loved a reserve of power now came along again and increased the size of the engine once more to cope with the extra weight, and behold! the cyclecar or light car was no longer a novelty. It was the old 12 horsepower friend in power, weight and price, perhaps more racy and efficient, and certainly still good value for money.

But others now had their say. One wanted a coupe body; others demanded a four-seated body. One bold person, seeing a new and long wheelbase, fitted his coupe body with four seats. And then a wag fitted it with seven seats, increased the wheelbase to 12 ft., and substituted a six-cylinder engine of 6,000 c.c.

And a potential buyer—he was an American millionaire—came along, looked at it, and bought a Rolls-Royce instead.—Light Car and Cyclecar.

FIRESTONE MAKES SOME RIMS

Firestone Tire & Rubber Co. converted 12,000 tons, or 24,000,000 pounds of steel into Firestone rims last year. Contractors estimate 1,000,000 pounds as a liberal allowance for a fairly large building. A working floor space of 150,000 square feet, a force of 400 men and a fine equipment of machinery, including 16 electric welders, find employment in this branch. Firestone rims will be used exclusively this year by sixty automobile manufacturers.

H. S. Firestone, president of the company, in an address before members of the Cleveland Advertising Club, January 21, told how rubber trees are grown and cared for and how rubber is transformed from the crude state into the finished product. Stereopticon pictures illustrated the lecture.

Mr. Firestone and other officials of the company attended the factory ball recently given by employes at an Akron dancing academy.

GROWTH OF GOODYEAR CO.

The Goodyear Tire & Rubber Co. recently made public a statement showing the growth of their pneumatic tire production for the past six years. In 1909 they made and sold 102,669 tires, and this number has shown a steady yearly increase, until in 1914 the number of Goodyear tires made and sold was 1,478,396. The demand for the company's pneumatics for heavy motor trucks is likely to further increase these sales. The company is now supplying a 38 x 7-inch tire with a rated carrying capacity of 2,500 pounds, a 42 x 9-inch carrying 4,500 pounds per tire and a 48 x 12-inch of 7,500 pounds carrying capacity per tire. All are of the No-Rim-Cut type and conform to the company's Ideal Detachable Rim, '07 profile.

THERMOID RUBBER CO. ENTERTAINS

A luncheon was given recently by the New York branch of the Thermoid Rubber Co., of Trenton, N. J., to the members and staff of the Weaver-Ebling Automobile Co., newly appointed agents for Nassau tires. J. O. Stokes, president of the Thermoid company, spoke on the policy of that concern; D. O. Pohlman, sales manager, discoursed on factory equipment and results given by Nassau tires in 1914, and J. N. Kirk, Jr., of the New York branch, described conditions in the local tire field.

VEHICLE FACTORY COST SYSTEM.

Revised Report as Finally Adopted by the C. B. N. A. Cost Committee.

The Cost Committee of the C. B. N. A., which presented a plan for a complete cost system at the Atlantic City Convention, on Sept. 30, 1914, have since that time made a careful revision of their report, and the plan in its revised form is printed below:

Report of the C. B. N. A. Cost Committee

Your committee has worked out a cost system that they feel sure will be a great benefit to all members who will take advantage of it. Should we not get benefits out of this association, that are of value in a practical way, so that the members can and will look to their association as a help and a guide? We feel that this report is one of such benefits.

We recommend that this report be printed, in pamphlet form, to be distributed among all the active members of this association and those associate members who may apply for it.

C. A. Eisenhardt, of the Sayers & Scovill Co., and L. A. Townsend, of the Durant-Dort Carriage Co., have assisted the committee, and have worked out the details of this report. Mr. Eisenhardt is here, and will submit the report, covering briefly its important details.

W. A. Sayers, Chairman.
J. D. Dort,
P. E. Ebrez,
J. W. Fulreader,
Committee.

After the reading of the report by Mr. Sayers, Mr. Eisenhardt said:

We are presenting two reports, one designated as Report No. 1, which is a full detailed cost system giving copies of all forms necessary to carry out the system with explanations of how to apply these forms to get the required information for cost records.

The other report is designated as Report No. 2, and is a modification of report No. 1, giving the basic plan of correct accounting so that members may use it as a guide to get the information from their records as they may now be keeping them.

Mr. Eisenhardt read extracts from Reports Nos. 1 and 2, which were quite voluminous. Referring to Report No. 1 he said:

The main idea of this report is based on the desire to not alone reduce manufacturing costs, but to eliminate ruinous and unprofitable competition, which is the result of guesswork costs and haphazard estimating.

The prevailing method of determining costs is upon an estimated basis, and no two carriage manufacturers follow the same plan in making their estimates.

This system is planned with the idea of requiring a minimum amount of clerical labor.

Because of local physical conditions, it will be necessary to modify many of these ideas to suit the particular needs of each organization, but in each case the underlying principles will be the same, and the results will be the same; that is to say, accurate, dependable, proven costs, based on a correct knowledge of the three elements of material, labor and expense.

At first thought these methods may seem to lead to a great deal of detail, but as a matter of fact they do not work out that way, and do insure that the work proceeds rightly.

The items of importance are:

First—Perpetual inventory of stock so that in one case you will not run out of stock and stop production; and in the other

case, so that you will not tie up too much money in surplus stock.

Second—Right care and issuing of material and parts to departments.

Third—Correct records of labor.

Fourth—Automatic check on piece-work count and day-work time.

Fifth—Proper reports of spoiled and defective material.

Sixth—Correct records of factory expense.

Seventh—Accurate, complete cost of product.

Finally, the most important point to bear in mind is, that it is not sufficient to have the form of system alone, but that the system must be so carried out as to be effective, and not a mere form, and this requires proper installation at the start and proper training of those who are to use it to make it entirely effective.

The pay-roll of each factory should be so arranged as to show the productive and non-productive labor in each department, for in making up the expense analysis the data, as far as labor is concerned, will be taken from the pay-roll. It often happens that producers spend some time on non-productive work, and the pay-roll should be so arranged as to show at each department, even where it is a productive department, both the productive and non-productive labor in that department. (The speaker referred to form No. 5a and 5b.)

In order that non-productive labor may be gathered accurately, we advise the use of a day-work time card, shown in form No. 6, and the productive day-work should also be shown on this card by operations, giving quantity of parts finished, which will afford a satisfactory means of supplying the cost department with proper labor costs.

For keeping record of piece-work performed, use coupon tags with a coupon for each operation, similar to form No. 7, adapted to work on operations in your factory.

In conclusion, it must be borne in mind that no cut and dried system can be laid down bodily in any plant and prove a success. At best the approved system can serve only as the basic plan from which to work, and the one hundred and one details must be carefully considered in each plant to guarantee the success of the whole.

The speaker then illustrated his remarks by referring to various forms he had prepared.

Referring to Report No. 2, the speaker said it was a slight modification of Report No. 1.

These reports were filed with the secretary, and are as follows:

Report of Committee on Cost System for Carriage Manufacturers

We are presenting two reports, one designated as Report No. 1, which is a full detailed cost system, giving copies of all forms necessary to carry out the system with explanations of how to apply these forms to get the required information for cost records.

The other report is designated as Report No. 2, and is a modification of Report No. 1, giving the basic plan of correct cost accounting so that members may use it as a guide to get the information from their records as they may now be keeping them.

Report No. 1

The main idea of this report is to give a simple yet comprehensive cost system.

Acknowledging the necessity of estimates for the purpose of

setting catalog prices before the goods are produced, the aim is to make this plan so simple that it may be adopted with satisfaction by all and to give an accurate knowledge of true costs, which is the prime necessity of making an accurate estimate.

It is intended to avoid anything that will necessitate a mass of red tape and useless figures, and the methods suggested have in one form or another all proven practical and easily operated.

This system is planned with the idea of requiring a minimum amount of clerical labor.

Because of local physical conditions, it will be necessary to modify many of these ideas to suit the particular needs of each organization, but in each case the underlying principles will be the same and the results will be the same, that is to say, accurate, dependable, proven costs, based on a correct knowledge of the three elements of material, labor and expense.

At first thought these methods may seem to lead to a great deal of detail, but, as a matter of fact, they do not work out that way and do insure that the work proceeds rightly.

The items of importance are:

First—Perpetual inventory of stock so that in one case you will not run out of stock and stop production; and in the other case, so that you will not tie up too much money in surplus stock.

Second—Right care and issuing material and parts to departments.

Third—Correct records of labor.

Fourth—Automatic check on piece-work count and day-work time turned into pay-roll department.

Fifth—Proper reports of spoiled and defective material.

Sixth—Correct records of factory expense.

Seventh—Accurate, complete cost of product.

Finally, the most important point to bear in mind is, that it is not sufficient to have the form of system alone, but that the system must so be carried out as to be effective and not a mere form, and this requires proper installation at the start and proper training of those who are to use it, to make it entirely effective.

Receiving and Stock Room

What is needed, is a central point of receipt of all goods entering the plant, with some one man designated to receive them, see that they are distributed to their proper channels for use and promptly account for the same on receiving report, Form No. 1, so that invoices may be checked and stock ledger entries made on Form No. 2.

One of the essential uses of a perpetual stock ledger is to be able to determine at all times the amount of material on hand.

All materials handled through the general stockroom must be delivered only on requisition to the different departments, signed by the foreman as per Form No. 3.

Such material that is not stored in the general stock room (but through the factory) and they enter into the manufacture of the regular product, such as wheels, axles, springs, etc., should be posted on the stock-keepers tally sheet. (See Form 4, from the daily working orders).

Materials used each day, as shown on Forms Nos. 3 and 4, are then posted to the credit of their respective items in stock ledger, Form No. 2.

Furthermore, to have an inventory of stock on hand over orders, material required for these orders can be listed from orders as received on Form No. 4 and then posted to Form No. 2, in column provided for this.

If perpetual inventory in dollars and cents is desired, these Forms Nos. 3 and 4 can be priced and extended and necessary credits given merchandise account by accounting department.

Pay-Roll

The pay-roll in each factory should be so arranged as to show the productive and non-productive labor in each department, for in making up the Expense Analysis, the data as far as labor is concerned will be taken from the pay-roll. It often

happens that producers spend some time on non-productive work and the pay-roll should be so arranged as to show in each department, even where it is a productive department, both the productive and non-productive labor in that department.

The object would be to run the pay-roll book to cover this division of labor like Forms Nos. 5-A and 5-B.

In order that non-productive labor may be gathered accurately, we advise the use of a day-work time card, per Form No. 6, and the productive day-work should also be shown on this card by operations, giving quantity of the parts finished, which will afford a satisfactory means of supplying the cost department with proper labor costs.

For keeping record of piece-work performed, use coupon tags with a coupon for each operation, similar to Form No. 7, adapted to work on operations in your factory.

Expense

Expense should be divided into two classes, viz.: Manufacturing Expense and Sales and Administrative Expense.

Under the head of Manufacturing Expense should be the items listed on Form No. 8.

Under the head of Sales and Administrative Expense should be the items listed on Form No. 9.

The accounting records should be kept in such a manner so as to enable the manufacturer to arrive at the different items listed in the Expense Schedule.

After a great deal of thought upon the subject, and considering it from every standpoint, we are convinced that the Manufacturing Expense ought to be considered only in its relation to productive labor. (See Form No. 8 as to method of applying this).

Sales and Administrative Expense should be applied on total factory cost, viz.: Material, labor and manufacturing expense. (See Form No. 9 as to method of applying this).

Costs

In the first place, there should be designated in each factory some one man, who shall have charge over and be held accountable for pay-roll and the gathering of all cost records.

His duties would be to compile statistics, which, of course, would be subject to the constant review by the superintendent or manager, and would be expected to pick out those things needing attention and bring them to the manager's notice.

The manager of any establishment has his hands full with the

Form No. 1.

RECEIVING REPORT.

Date No.

Received from

Via Charges

Quantity	ITEM	Weight

details of the manager's problems alone, without attempting to handle the costs, and he ought to have the assurance that he can turn to his cost clerk and secure the necessary information when he needs it, and on time.

This man would handle the piece-work coupons and the time notes and all information used from them, check them with the clock cards, work up operation cost records, the excess labor

cost, the cost of finished product and other desirable factory statistics.

The material and labor costs on each job should be compiled as per Forms No. 10. These forms show complete list of material and labor required for a complete buggy and will serve as a guide or example.

After having determined the material, direct labor, manufacturing and sales and administrative expense, the final cost should be compiled as per Form No. 11.

Form No. 2. Card No. _____

Article _____

Where Used _____

Quantity Used Previous Season _____

Maximum _____ Minimum _____ Location _____

ORDERED		RECEIVED		USED		BAL-ANCE	ORDERS REC.		ORDERS FIL'D		UNFIL'D
Order No.	Quantity	Report No.	Quantity	Req. No.	Quantity		Date	Quantity	Req. No.	Quantity	

Explanation of Form No. 1

This form is made out by receiving clerk in duplicate for all materials received. The original is sent to the stock clerk to be posted on stock ledger, then it is sent to purchasing department to check invoice. The duplicate is retained by receiving clerk for his record.

Explanation of Form No. 2

This is the Stock Ledger Card for perpetual stock record of raw material. The first column marked "Ordered," is to show amount ordered from accessories; the second column, marked "Received," is to show amount of raw material received; this is taken from Receiving Report No. 1; the third column, marked "Used," is the amount issued on Material Requisition No. 3, to both foremen and stock clerks; the fourth column, marked "Balance," shows balance of material on hand not in process; the fifth column, marked "Orders Received," is provided for anticipating stock required for all orders whether for immediate or future shipment; the sixth column, marked "Orders Filled," is material required for orders on working schedule; this information is derived from Form No. 4; the seventh column, marked "Unfilled Orders," is difference between columns five and six. Columns five, six and seven are intended only for main items of stock requirements, such as wheels, bodies, seats, axles, springs, etc., as it would entail too much detail to apply this method to all items. However, columns one to four, inclusive, are intended for all items.

Form No. 4.

STOCK-KEEPER'S TALLY SHEET.

Schedule No. _____ Date _____

SHAFTS		WHEELS		AXLES		GEAR SETS		SPRINGS		LOOPS		BODIES		SEATS		DASHES	
Style	Quant.	Style	Quant.	Style	Quant.	Style	Quant.	Style	Quant.	Style	Quant.	Style	Quant.	Style	Quant.	Style	Quant.

A place is provided at top of card for maximum and minimum amount to be carried—this for guidance of stock clerk. The amounts should be set by the manager.

Explanation of Form No. 3

This requisition is for material stored in the general stock room and must be signed by foremen and should be for stock sufficient to build work according to individual schedule or working list. Should also be used in drawing supplies that should be kept in general stock room and noted what supply is intended so that it can be charged to proper expense item. Requisitions for expense items must be made on separate blanks

Form No. 3.

MATERIAL REQUISITION.

No. _____

Date _____ Dept. _____ Order No. _____

Storekeeper: Please deliver the following:

Quantity	DESCRIPTION	Price	Amount

Signed _____ Date Filled _____
Foreman.

from regular stock requirements. After requisition has been filled, it should be turned over to stock clerk and posted on Stock Ledger Card, Form No. 2, column 3. After stock clerk has taken his record, this requisition should be sent to accounting department to be priced and charged to proper account.

Explanation of Form No. 4

The form, as outlined, is simply a suggestion to be adopted so as to conform with items of stock you desire to handle outside of general store room. Stock keeper should take his first record off from orders as soon as received and post to columns marked "Orders Received," on Stock Ledger Card, Form No. 2.

The orders can be so marked and work so handled in this connection so that unless there has been some change in the order before it is actually scheduled in factory, the second tak-

THE AMERICAN EXPORTER AFTER THE WAR

The present state of affairs in Europe will have a so far-reaching effect on the methods of distribution and sale of American products in Europe that a drastic change of system in some respect may be expected after the war.

In the past, the requirements of the home trade have absorbed the attention of the American manufacturer, and inquiries from abroad have received but scant attention. In recent years, however, there has developed a special branch of the export business to establish connections between the producer and the foreign consumer, and since that time the subject has received more and more attention, writes Frederic W. King, member of the American Association of Commerce and Trade, Berlin.

To the manufacturer, having little time, or, sometimes, little desire, to become directly acquainted with foreign trade, the export house has proved an ideal method of disposing of orders from abroad, and one which involves the minimum of risk and expense. The natural result of this has been the expansion of the export business from certain well defined lines into a general distributing business, covering a wide range of activity. Exclusive territory and sales rights, in some cases covering the entire continent of Europe, have been secured by the export interests, the American manufacturer considering himself fortunate in being able to place his products in foreign markets on this basis.

That this system has proved practical in the past is beyond dispute, but it now appears as if the American manufacturer would be forced to take a personal interest in the foreign consumer, if he wishes to hold his trade and prosper in the new order of affairs.

This statement applies directly to firms who surrender larger sale privileges to the distributor. Their products after arriving in Europe are usually reshipped from some center to various parts of the territory. Sometimes, also, the case occurs in which the territory in question includes a number of countries, and this necessitates the reshipping of products. In this way goods lose to a certain extent their identity and take the nationality of the country in which the central distributing point is located.

Frequently this is due to the breaking up of the original shipment from America into small portions, which are often packed with goods of European origin, and received by the retail trade with little left in the way of packing marks or address to call attention to their American origin. The result of this change of identity is that the products lose their neutral character and are subject to the prejudice endangered by the upheaval now going on.

Regardless of the ultimate outcome of the war, this state of feeling will render the consideration of each country as a separate unit advisable and the nationality of the products must be emphasized in every way possible.

The foreign trade question is a severe problem for the American manufacturer, and it is realized that in many cases, if the foreign distributor be counted out as a factor, there would be no solution of the export question for a large number of American firms, as direct propaganda involving the opening of branch offices requires considerable outlay of capital and above all a staff thoroughly in touch with the business methods of the territory under consideration.

Thus, to many, the foreign distributor will remain the only channel of communication between the producer and the foreign retail trade, and this method may continue to be used with advantage in the future, providing the manufacturer takes practical measures to get in touch with his trade and establishes his identity.

These results can be secured with minimum outlay, whether the interest in continental trade be great or of moderate extent, by the appointment of a representative to look after the interests of the firm, thus forming a link between producer and consumer.

An active representative, while not selling goods direct, can

do much to extend trade and increase the sales of the distributors.

It is his duty to see that the goods receive fair treatment and that they are placed on the market as the products of the firm he represents. It is also his duty as far as possible to become personally acquainted with the trade, study its requirements, adjust disputes, and in a word, make his customer feel that the producer is taking a personal interest in his efforts to dispose of his wares.

The lines handled by many distributing houses cover a wide range. It is, therefore, self-evident that the individual product can receive but a portion of the attention devoted to the entire business. Without doubt, distributors will be very pleased to dispose of all the goods there is demand for, but who is to create the demand? That should be one of the most important duties of the firm's representative.

In building up such a trade the question of advertising is important, and this department should be also in the hands of the firm's agent.

This system requires, of course, the cordial co-operation of the distributors to make it a success, and it is to be expected that the proposition will meet with little favor at first and probably with energetic protests from some of the holders of exclusive sales rights, who will hold that the placing of a representative in their territory is an attempt to interfere with their private business, without considering the fact that his presence will, in the long run, prove of quite as much value to them as to the firm in question.

RUBBER COMPANY INCREASES CAPITAL \$1,000,000

"The \$1,000,000 increase in the capital stock is to take care of our natural increase in business," said President Byron C. Dowse, Federal Rubber Manufacturing Co., Cudahy, Wis., which recently filed articles with the Secretary of State, increasing stock from \$2,000,000 to \$3,000,000.

"We are running twenty hours a day to take care of our business, and we have had no period when a layoff was necessary. We now employ 1,200 men and at times employ as many as 1,600.

"So far we have not taken any orders from European countries which are at war, as we have hardly been able to take care of our home business. We have made several additions to our plant, and will make more undoubtedly."

READY MIXED PAINTS IN THE U. S. NAVY

The paint and varnish industry has advanced more within the last ten years than it had advanced in the previous three centuries.

Up to recently practically no use was made of ready-mixed paints in the navy; the raw materials were issued and mixed on board ship when required for application. Early in 1911 a change was instituted by which paints mixed ready for use are issued to naval vessels in place of the raw materials. This change is in line with commercial practice, as nearly all the large manufacturing concerns and railroads issue and indeed purchase their paints ready for application. The sale of mixed paints in the United States is said to exceed sixty million gallons annually.

ARMY WAGONS ORDERED

The British War Office recently placed an order for 200 army wagons with the Port Arthur Wagon Works, Port Arthur, Ontario. These differ largely from the usual farm wagon. The box is arranged for a tarpaulin to be snapped on. The axles are extra clipped and have a steel skein. The pole is designed so as to stand any strain that is not abnormal. The concern had already filled a previous Government order for 150 of these wagons.

AMERICAN HORSES IN THE WAR

August Belmont, the New York millionaire horseman, in discussing the war, declared that the horse in the European armies is as much of a hero as in the conflicts of many years ago. He showed that the splendid quality of the horses in the German army was directly due to the maintenance of the National Stud, which is fostered and encouraged by the Kaiser. He said that the Austrian government had profited greatly by the extensive purchases of American-bred trotters. In short, Mr. Belmont insisted that the cavalry and artillery horse was of just as much importance in war as the submarine, the aeroplane, the motor car, the battleship, the rifle and the siege gun.

The French government spends millions of dollars each year in conducting a breeding establishment. Sunday racing in France in time of peace has attracted 50,000 persons, who pay 25 cents each to gain admission to the course. Racing, therefore, helps to defray the expenses of the stud in that country, just as it does in Germany, England, Russia, Italy and Austria. In this country, however, the antipathy to the turf has harmed the breeding industry to such an extent that Mr. Belmont and others say that we have the poorest horses in the world.

Many American-bred horses, by the way, were commandeered by the French army when war was declared. Nealy 50 were taken from the stable of William K. Vanderbilt. Mr. Belmont lost four colts by the mighty Rock Sand. Alfred Vanderbilt donated his coach horses—American hackneys. Ambrose Clark's jumpers and hunters, bred in this country, also were taken, together with the thoroughbreds owned by Herman B. Duryea, John Sanford and the Hitchcocks.

The movement to build up the American breeding industry, so that the army may receive necessary benefits, will be headed by such public spirited turfmen as August Belmont, Joseph E. Widener, H. B. Duryea, W. K. Vanderbilt, H. P. Whitney, John Sanford, Thomas Hitchcock, F. R. Hitchcock, Thomas F. Ryan, C. K. G. Billings, Alex. Smith Cochran, Gifford Cochran, H. L. Pratt, W. R. Coe, Schuyler L. Parsons, James Butler and others who will race next season. It is understood that General Wood will try to persuade the government to co-operate on a liberal scale.—Thoroughbred Record.

SECURING CELLULOID TO WOOD

The best method is to scrape the wood and celluloid clean, and then heat some grain alcohol to the boiling point. As alcohol boils at a relative low temperature and is very inflammable it should be held at a considerable distance from the source of heat. When the alcohol has been warmed to the desired point, it is applied to the under side of the celluloid with a small brush. The celluloid is then pressed down on the wooden strip to which it is to be secured and held tightly in place for about two minutes. It is said that nothing except fire will ever make the celluloid come off. The same method may be used for sticking celluloid to celluloid, celluloid to hard rubber and celluloid to glass.

ORIGIN OF FIRES

Investigations made by the Wisconsin legislature into the causes of fires occurring in 44 cities, with an annual fire loss of \$44,000,000, showed that the presence of rubbish caused 4,452 fires and that 2,663 originated in the careless use of matches. Nearly 17 per cent. of all the fires are due to these two causes.

PROPER METHOD OF CLEANING UPHOLSTERY

The well known cleansing properties of gasoline make the temptation to employ it for cleaning the leather of the upholstering a strong one; but gasoline has the unfortunate effect of dissolving the enamel on the leather, so that the finish is

removed along with the dirt. According to one who knows, nothing is better than white castile soap and warm water as the best cleansing agents for leather of the kind used for automobile seats, and the washing and drying should be followed by a rubbing with a soft cloth sprinkled with a few drops of olive oil, the last vestige of which should be removed with a dry, soft cloth.

RATE DECISION

The Interstate Commerce Commission, in a formal opinion, dismissed a complaint filed by the Milburn Wagon Company, of Toledo, Ohio, which alleged that rates on horse-drawn freight vehicles, farm wagons, carts and dump wagons to Illinois, Wisconsin, Minnesota, all States west of the Mississippi River and the Republic of Mexico are "inherently unreasonable and on a relatively higher basis than from Chicago, Milwaukee, Racine and other indicated cities, to the undue and unreasonable advantage of those places." It is held by the commission that "Toledo and the other cities are not similarly circumstanced, and the adjustment of rates from the former does not appear to be inherently or relatively unreasonable."

The Big Four, Vandalia, Katy, Missouri Pacific, Frisco and Rock Island roads were among the defendants in this case.

RELATIVE BURNER CAPACITIES

Quite a number of American-made lamps use German or English acetylene burners, and these are often stamped with their capacities in litres rather than in cubic feet. In order that the proper burner size can be had, no matter what the capacity markings, the cubic foot ratings are given with their corresponding litre ratings. A burner that consumes gas at the rate of one cubic foot per hour is the same as the one that consumes at the rate of 28 litres for the same interval. A quarter-foot burner is then the same as a 7-litre burner, and a half-foot burner equal to one rated at 14 litres. The 21-litre burner will take the same amount of gas as the three-quarter-foot burner, and all of these can be interchanged without affecting the consumption of gas from the tank or generator.

OHIO ELECTRICS NUMBER 3,800

The Ohio Electric Car Co., Toledo, Ohio, has manufactured and sold approximately 3,800 electrics to date. Over 400 of the cars are operated in Toledo.

The company was incorporated in the spring of 1909, and began operation in a comparatively small way in the Milburn Wagon Works plant. At its beginning the officers considered building only a small number of cars for local trade, but were encouraged, when their cars sold readily, to increase the production.

In the spring of 1911 a new factory was erected on West Bancroft Street. In 1913 the continued growth of business made necessary the construction of another building, making the total floor space approximately three acres.

COTTON IN DEMAND

Cotton in Germany is quoted at a price a little over 20 cents a pound, and it is reported that 2,000,000 bales will be required in that country in 1915. The American ambassador in Berlin says the question is not how much does Germany want, but how much can the United States engage to supply. Austria wants 800,000 bales; Italy, for which formerly 700,000 bales have sufficed, is now prepared to take 1,000,000 bales. As cotton is not contraband, and Great Britain, France, Germany and Austro-Hungary have given formal assurance that it will be so regarded, the principal thing is to secure a sufficient number of neutral vessels to transport it.

AUTO TRUCK HAULING IN PREFERENCE TO RAIL

Successful competition of the commercial auto-truck with the steam and electric railroad in the hauling of short-distance freight and passenger business, is given as one reason for extensive road improvement, in the report of the Joint Congressional Committee on Federal Aid to Good Roads. Discussing this phase of the subject, Hon. Jonathan Bourne, Jr., Chairman of the Committee, says:

"A great system of rural transportation would be developed, with rates regulated by actual competition, open to rich and poor alike, as no expensively privately owned terminals, roadbeds, tracks, or equipment would be required. The good wagon roads would be open everywhere to the use of everybody, and the equipment, relatively inexpensive, would be within the means of many.

"This suggestion as to the use of rural roads by commercial auto-trucks and buses, is not merely a product of imagination. In several instances gasoline propelled buses are now competing successfully with city or interurban electric lines, and, where the haul is but a few miles, transportation of freight by auto-truck is found cheaper and more satisfactory than transportation by rail.

"In the case of the short haul, the saving in handling and in time more than counterbalances the lower rail rate. Instead of loading the commodities on a truck, unloading at the local railroad station, where they must be loaded upon the cars, hauled to the near-by city and then unloaded and again loaded upon a truck and hauled to the consignee, the user of an auto-truck who has a hard surface road available loads his products once, hauls to the door of his consignee and unloads, saving not only the handling but the time, the inconvenience of issuance of way bills and receipts, and avoids damage to goods or deterioration while in transit.

"We believe that permanent highways will result in very considerable adoption of auto-truck hauling in preference to rail transportation, where the distance is within a half day's run."

C. B. N. A. BUYERS' GUIDE

The C. B. N. A. Buyers' Guide for 1915, published by the Carriage Builders' National Association for the benefit of the associate members, has just been issued. It contains a classified directory of manufacturers and jobbers of vehicle parts who are members of the association. It was compiled for the purpose of providing a handy means of quickly finding the names and addresses of the several firms making or handling any particular article.

The headings, representing the various lines, are arranged in alphabetical order, so that finding any given list of manufacturers is as simple and easy as finding a word in the dictionary.

Purchasing agents of materials used in carriage, wagon and automobile body factories should keep this book "within fingers' reach," and use it constantly as a buying guide. They will find it a great convenience.

Besides being a complete purchasing guide, the book contains the names of officials of the C. B. N. A., and the full list of members, active, associate and honorary, revised to January 1, 1915. A calendar for the current year and 20 pages of ruled writing paper for memoranda complete the book, the whole being strongly bound in round-cornered cloth covers.

GET-TOGETHER

Travelers and Officers of Troy Wagon Works Co. Hold Meeting

A feature of the recent first annual "Get Together" meeting of the Troy Wagon Works Company, of Troy, Ohio, was an exhibit of the various products of the company. Although

there were a number of types that it was not possible to show, thirty-four wagons and six trailers, all of different kinds, were displayed, and, side by side, they made a line four hundred feet long.

Announcement of a number of improvements on the Ajax wagon and the truck trailers had been reserved for this meeting. The meeting also gave the sales force an opportunity to see the latest trailer models of 5-ton, 2½-ton and 1½-ton capacity.

The convention, which lasted three days, from January 6 to January 8, was attended by the entire staff of the company as well as the home office force. The program included discussion of construction of the various Troy products and different phases of salesmanship.

A large part of the first day was spent in the factory. In the evening, W. F. Jolley, sales manager, entertained the field force at dinner at his home, followed by a smoker. On the second day the gathering watched the building of trailers in the factory, and a feature of the last day was a talk by W. E. Long, vice-president of the Geiger-Jones Company, of Canton, Ohio.

Every man in the field had a part in the program as round tables were held after nearly all the talks. This feature stirred up much enthusiasm. It was determined to make the "Get-Together" an annual affair.

GERMANY RESTRICTS SALE OF TIRES

Sale or other disposition of every sort of tire for passenger and other vehicles, and for motorcycles, is prohibited in Germany, this prohibition including old tires and those containing flaws. Dealers are forbidden the distribution of such goods, and rubber factories the filling of orders, even those placed previous to the enactment of this rule. Permits are obtainable from the authorities for the distribution of repaired or imperfect tires incapable of repair by the makers—this only in cases where the maintenance of a public vehicle service, a commercial undertaking or a medical practice is involved and would be rendered impracticable without rubber tires. Applications for such permits must be made under local police certification to the department of inspection for military, air and power vehicles, and must indicate the nature of the vehicle, the number of such vehicles, tires and tubes in the possession of the applicant, the number of tires requiring to be changed, etc., and in some localities the vehicle to be re-tired must be submitted to the bureau of inspection or to the military authorities.

STRETCHER CARTS FOR WAR ZONE

Two or three thousand stretcher carts are being made by the John Deere Wagon Company for service in the war zone. The cart is nothing more than a stretcher on wheels, according to Frank D. Blake, of the company. An ordinary stretcher is mounted on two wheels and is pushed by one man instead of being carried by two as the ordinary stretcher requires.

The report that the Deere company is making 3,000 ambulance wagons is unfounded, according to Mr. Blake. Some of the stretchers are being made at Moline, Ill., and some at the Marseilles factory.

NEW RUBBER TIRE COMPANY

The New Castle (Pa.) Rubber Co. has been incorporated with a capital stock of \$500,000 by John S. Wilson, Edwin N. Ohl, James D. Rhodes, Charles H. Bolton and W. H. Shoen of Pittsburgh, and Alex. C. Hoyt of New Castle. These gentlemen, with E. H. Brainard and A. B. Berger of Pittsburgh, and G. P. Rhodes of New Castle, constitute the board of directors for the first year. The company will occupy the old forge and bolt works, which is already being remodeled to suit the needs of the company. Automobile tires, inner tubes and auto accessories will be manufactured.

MOTOR CARS, CARRIAGES, AND CARTS IN WEST AFRICA

According to Consul W. J. Yerby, writing under date of November 12, road conditions in Sierra Leone make it difficult to use motor cars, though in Freetown there are two traffic cars used by the government, two for the general traffic of a private firm, and two pleasure cars. No others are in use in this colony. All are English make, except one of the pleasure cars, which is from France. Only two or three mule carts are in use, and there are no passenger or pleasure carriages, as neither horses nor mules thrive here.

Trucks, motor cars, and other vehicles for industrial or commercial purposes, and accessories thereto, when imported at the same time as vehicles, are admitted free of duty; on purely pleasure cars the duty is 10 per cent.

French Senegal, through Dakar, its principal port; the Gold Coast, through Accra; and Nigeria, through Lagos, are importing both traffic and pleasure cars. Nigeria promises to import larger numbers, as the public roads there are well suited for their use. Motor vehicles are free of import duty in Nigeria and Gold Coast. In Senegal they are dutiable at 5 per cent. ad valorem, with a surtax of 7 per cent. on goods of other than French origin. There is also a local "octroi" on articles imported through Dakar, amounting to 5 per cent. ad valorem.

Most of the cars imported by the Gold Coast and Nigeria are American. The trucks are substantial cars, used for hauling heavy traffic from 50 to 100 miles, but as a rule over fairly good roadways. The passenger or pleasure cars are of the Ford type. In fact, at least 20 of these cars were in use in Lagos last January, and all American cars seem to give general satisfaction. The government of each of the British West African colonies purchases truck cars in connection with both railway and public works departments.

There are no dealers in motor cars in West Africa, but almost any of the principal importers would be interested in acting as agent.

The four traffic cars, or motor lorries, and two of the pleasure cars in use in Sierra Leone were imported in 1911 and 1912, and one pleasure car in 1914. The Gold Coast imported 636 carriages and carts, including motor vehicles, valued at \$153,233, in 1912. Of these, the United States furnished directly 113, valued at \$5,016. In 1913 the Gold Coast imported 1,169, valued at \$258,006, and of these the United States furnished directly 50, valued at \$15,116. The comptroller of the customs says that most of the light carts and light motor lorries imported through England are of American origin.

In 1912 Nigeria imported carriages and carts except railway carriages, 872, valued at \$16,789; motor cars, etc., packages, 87, valued at \$40,939. Of the first, the United States furnished directly 65, valued at \$1,450; of the second, two, valued at \$1,099. In 1913 Nigeria imported 628 carriages and carts, valued at \$34,289. Complete statistics for 1913 for Nigeria are not available at this time.

The government of Nigeria operates several motor-car traffic lines as feeders to the railways, having in use, during 1913, one 4-ton 40-horsepower Halley Tip Wagon; one 24-hundredweight 16-horsepower Lacre; three 2-ton 16-horsepower Lacre; one 3-ton and six 2-ton 24-horsepower Thorncroft motors. The government has, besides these, other cars in use, as have nearly all of the larger trading firms.

The Gold Coast has a motor traffic ordinance which states: "From and after the first day of January, 1915, no motor cars shall be used unless fitted with a silencer. The use of cut-outs and open exhausts is strictly prohibited."

CAR STOPPING SERVICE

The National Implement and Vehicle Association has employed special counsel to prepare and present the case of the manufacturers and dealers against the railroad companies in the

matter of the proposed withdrawal of the stoppage in transit service. This same counsel will look after the interests of the members of the association in opposing the unreasonable advance on freight rates on export shipments and other matter involving freight.

The Chicago hearing on the stoppage in transit service will be held in this city March 23 when an examiner for the Interstate Commerce Commission will take testimony of implement manufacturers and dealers relative to the importance of continuing the present stopping rule.

THE JINRIKISHA AND ITS TIRES IN CHINA

Three kinds of jinrikishas are used in Manchuria—iron, rubber and pneumatic tired, at prices from \$30 to \$50. The pneumatic tire is intended for use with the Chinese type of jinrikisha, which is rather smaller than the other two. An estimate places the total number in various parts of Manchuria at: Chanchin, 650; Futien, 3,000; Reijon, 127.

Rubber tires, says the Japanese correspondent of The India Rubber World, are imported into Manchuria either through Chinese merchants in Futien, who gather them from other districts, or through Japanese dealers at Chanchin, who buy from the manufacturers in Japan. About 70 per cent. of the total are solid rubber tires and 10 per cent. rubber pneumatic tires. The solid rubber tires used on these jinrikishas cost \$8.50, and the pneumatics \$12.50. At Futien rubber tired jinrikishas are selling at from \$36 to \$45 in the cheaper grades, up to \$56.25. Solid tires are imported from Tokio and Osaka.

The carriages, wheels, tires and other parts of jinrikishas are imported principally from Osaka, and assembled by the Japanese merchants at Futien, who sell the vehicles to Chinese dealers in completed form. The latter distribute them to private consumers on the instalment plan.

Dealing with other parts of China, there are in Chefoo 450 jinrikishas, those using solid rubber tires costing from \$18 to \$23 for common to \$36 for superior grades. Wheels in conjunction with solid rubber tires cost \$9 a pair. Foreigners have shown a preference for jinrikishas with solid rubber tires, but the Chinese have continued to use the cheaper iron-tired vehicle. It is anticipated, however, that improved roads will develop the use of rubber tires.

Shanghai has two kinds of jinrikishas, the Foboche with a rubber pneumatic tire—of which there are about 10,000—and the Yajiche, numbering some 2,000, with iron tires. In addition there are about 2,500 Foboche for private use. The 12,500 Foboche used in Shanghai are fitted to the extent of 80 per cent. with pneumatic rubber tires, of which 30 per cent. come from the Dunlop Rubber Co. (Far East), Limited, of Kobe, whose manufactures are guaranteed for six months.

In addition to the Dunlop company, the Michelin company does an excellent business in tires, the Foboche having been originally a French article, and most of the persons hiring out jinrikishas being Frenchmen. The French goods, while not guaranteed and slightly dearer, are said to be rather better than the Dunlop make. Besides the Dunlop and Michelin companies, the Continental Rubber Co., a German concern, supplies 20 per cent. of the demand under a six months' guarantee.

The jinrikishas in Shanghai require about two pairs of tires each in a year, or for the 12,500 Foboche in use, 25,000 pairs annually, with a value of \$200,000 on the basis of \$8 a pair.

In Hong Kong there are 2,200 jinrikishas, the majority of which have solid rubber tires, imported from the Dunlop Rubber Co., London, and other British and German firms.

Pneumatic rubber tires are not used in Hong Kong, the unevenness of the roads being responsible for the demand for a strong, solid tire. The Hong Kong jinrikisha makers import the parts from Great Britain, Germany and Japan, and ship their products to other parts of China. The largest maker in Hong Kong is Koche Konau, with a capital of \$25,000 and 800 vehicles for hire.

CANINE TRANSPORT OF BELGIUM

Equine transport in Belgium is comparatively unknown. The place of the horse in that country is taken by the dog, of which large numbers have been employed by Belgian troops for pulling machine guns. Curiously enough, this form of traction has only been adopted within the last year or two, and only 15 months ago a Belgian service paper wrote approvingly of the experiment, pointing out that, in addition to being docile and competent, the animals had become great favorites among the soldiers. Among their advantages it was mentioned that they move silently, without apparent effort, over the roughest country, and that they are practically invisible a few hundred yards away. With striking prescience, the writer observed that the military Great Danes would be called upon to play a particularly effective and glorious part, little realizing probably how soon his words would become true. According to correspondents, the dogs have more than justified themselves. As it happens, the military authorities in Belgium must have found plenty of material ready to hand, since dogs are of considerable economic value in that country. Something like 175,000 are in constant use for drawing small carts, which to us are such a novel and conspicuous feature of life in Belgium. Butchers, bakers, milk venders, small farmers—all have their dog teams. An early seventeenth century painting proves that the custom existed in those days, but it was not more than 12 years ago that a society came into being, the object of which was to encourage the breeding of a more powerful animal, to ameliorate the condition of those employed, and to replace those that die, free of charge to all owners who contribute the very moderate insurance premium of two francs annually. Economists having estimated the daily worth of each dog variously from sixpence to a franc, it is easy to see how materially this canine army contributes to the wealth of the nation. The National Federation for the Breeding of Draught Dogs has a membership of over 2,000, and its operations are under the control of nine syndicates—one for each province. The Belgian and Provincial governments, recognizing the importance of the work, contribute annual subsidies to the federation. In that sad exodus from Antwerp it was interesting to read that the brave dogs were doing their part, dragging the effects of their hapless owners or easing the journey of children or old people.

A SOLDIER'S LOVE FOR HIS HORSES

The affection of a British soldier for the horses in his charge is related in a letter from a captain of the Indian Army Supply and Transport Corps to his wife. The writer says of this soldier that he "attracted my attention during that awful first night in this country. He was almost crying because he could not find the horses he had had since he first joined. In the confusion of disembarking in the dark he had lost them, and said he did not care if they shot him now he had lost all he cared for. I consoled him as much as I could and promised him the best horses I could get at the end of our railway journey. I learned such a lot that day. My friend who loved his horses I made a corporal as soon as possible and put him in charge of all the sick horses, and he has done awfully well and has now been transferred to the veterinary establishment. He had been a trainer in civil life."

COSSACK CUTENESS

How a Cossack daringly outwitted his Austrian captors is told in a despatch from the Russian scene of operations. An Austrian general, finding his men unduly terrorized by legends current of Cossack prowess, decided to teach them that the Cossack was only an ordinary soldier, and ordered them to take one alive at all costs. This, after some time, was done, and the Cossack was brought bound before the general. The

general read his men a lecture from horseback, and explained that he would prove that a Cossack was nothing in particular. He ordered the prisoner to be released from his bonds and bade him kiss the cross round his neck. Finding that the Cossack readily understood signs, he explained that he would give him a sword, and he must show what he could do with it. The Cossack, whirling the sword around, and with a wild cry which is part of the language used by all horse-loving peoples of the world in all ages, and has a curious effect upon the equine species, suddenly leaped up behind the general. He forced the horse to charge into the crowd of soldiers, who were unable to shoot for fear of killing their own chief, and made a ready way before them. The Cossack headed for home, and the Austrian outposts, surprised by the curious apparition, sent a few wild shots after the pair without effect, and the general went into captivity fully persuaded that there was after all "something diabolical" about these Cossacks.

OHIO AUTO DEALERS ORGANIZE

A meeting of automobile dealers of Ohio was held at the Virginia Hotel, Columbus, Ohio, Thursday, Feb. 4, at 5 P. M., for the purpose of forming a State auto dealers association.

L. M. Browne, who is president of the Columbus Auto Trades Association, spent weeks on the proposed organization, traveling over the State to enlist the co-operation of men prominent in the industry, resulting in the almost complete representation from each of the eighty-eight counties in the State.

It is the idea to organize a local dealers' association in each of the eighty-eight counties of the State, the local bodies to be affiliated with the State Auto Trades Association.

At this first meeting, a temporary organization was affected, and L. M. Browne was elected president, and J. P. Gordon secretary. The following vice-presidents were elected: W. S. Barrett, Chillicothe; W. Faunce Youngstown; C. L. Hansberger, Lancaster; C. M. Ross, Johnston; J. C. McBeth, Upper Sandusky; W. L. Huffman, Marysville; Mr. Shaner, Circleville; Mr. Rathburn, Springfield, and J. P. Hoffman, Plain City.

MITCHELL-LEWIS COMPANY ELECTS OFFICERS

H. L. McClaren was re-elected president and general manager of the Mitchell-Lewis Motor Company at the annual meeting of the directors following a meeting of stockholders.

Other officers named were:

First vice-president, John W. Bate; second vice-president, W. T. Lewis; treasurer, F. L. Mitchell; secretary and assistant treasurer, William H. Armstrong; comptroller, Martin J. Gillen.

The board of directors is made up of the following: H. L. McClaren, F. L. Mitchell, J. W. Bate, W. T. Lewis, O. C. Friend, W. H. Armstrong, M. J. Gillen.

The reports of the officers showed that the Mitchell-Lewis company has sold and manufactured more cars from Aug. 1, 1914, to Jan. 1, 1915, than during any similar period of time in the history of the concern. The debt of the company is now lower than at any previous time and prospects for future growth and expansion are declared by the company's officers to be excellent.

LOGWOOD DYES

Logwood dyes still are being substituted, as far as possible, for aniline dyes, importations of which have been unsatisfactory since the war began, it is said at the Philadelphia office of the American Dyewood Co. Logwood dyes are extensively used in the leather and silk trade. Exports have diminished as the war has progressed, and there is lessened consumption for leather, but their use has been extended in some textile lines. The aniline dye situation continues to be very unsatisfactory, dyers complaining of a scarcity of developer.

THE NEW DEMAND FOR HORSES

During the next decade there will probably be an increased demand for American horses in the countries now engaged in the European war. The demand may even continue much longer, according to investigators of the United States Department of Agriculture, as not only will horses be needed for armies, but when peace is restored more will be needed for agriculture. Already European agents are purchasing horses in this country and Canada, and there is an increased interest in many sections in horse breeding.

To meet this increased European demand, American farmers may well endeavor to raise well bred horses, although the Department of Agriculture does not advise them to purchase a surplus of horses merely for breeding purposes. It merely advises that ordinary farm work should be done whenever possible by good mares which should be bred to good stallions. It also desires to emphasize the fact that only horses of high quality may be profitably raised today. Inferior horses are a drug on the market, and their production is to be discouraged as much as the production of good horses should be encouraged.

The United States has previously been drawn on to supply European countries at war. In the Boer war over 100,000 horses were bought here by the British government. It may be doubted whether a foreign government could now obtain a similar supply in this country, except at excessive cost. However, if farmers take pains to utilize their good mares during this winter to breed them to good stallions, in the course of several years (time enough for the foals to develop), America will be better able to meet the European demand.

It is natural that European countries should look to the United States for horses as, next to Russia, it has more of these animals than any other country in the world. The United States and Russia possess 58 per cent. of the world supply. Strange to say, however, there were no horses originally on our continent, and the present supply comes from the stock brought over from Europe. Canada's supply is small compared to our own.

War as a Consumer of Horses

The German army requires for a complete mobilization 770,000 horses and the French army is said to require 250,000, which figure, however, probably includes only those for the cavalry. It is conservatively estimated on good authority that 1,000,000 horses are now engaged in the European war. As the greatest majority of these horses are not included in the permanent military organization, but are used for farm work and are requisitioned by governments only when needed for military purposes, the countries of continental Europe will certainly face an acute shortage of farm horses before the next planting season which will seriously affect the price of horses the world over as soon as peace is declared.

According to the best information, horses in the countries of Europe now at war number as follows:

Great Britain	2,231,000
France	3,222,000
Belgium	263,000
Germany	4,523,000
Austria-Hungary	4,374,000
Russia	24,652,000
Total	39,265,000

In addition England has a supply of about six millions to draw on in her various dependencies. Russia has about ten millions in Asia, and France probably has 500,000 to 1,000,000 in her colonies.

The rapacious consumption of horses in war is illustrated by figures from our own Civil conflict. During his Shenandoah valley campaign, Sheridan was supplied with fresh horses at the rate of 150 per day. In his report for the year 1865, the quartermaster general of the United States army stated: "The service of a cavalry horse under an enterprising commander has averaged only four months." During 1864 there were 500 horses

consumed per day in the northern army, without considering those captured and not reported. During eight months of that year the cavalry of the Army of the Potomac was remounted twice, nearly 40,000 horses in all being required.

Our Own Army a Desirable Market

Our own army furnishes a desirable market for well bred horses, there being under the remount system at least 5,000 horses required annually to supply both the army and the national guard. There are now about 20,000 horses in our regular army on a peace basis. In war many more would be required before the first engagement. There is, therefore, a steady market for good horses independent of the European demand. Even the invasion of motor power, which has reduced the number of horses on our streets, has not influenced this demand. In fact, the price of horses has advanced along with other commodities during recent years.

The Bureau of Animal Industry of the United States Department of Agriculture, Washington, D. C., stands ready to aid any farmer desiring to breed high class horses. As the day of the large horse ranch is practically gone, any increased demand will have to be met by the farmer. There are certain localities more suited to horse breeding than others, and places where certain breeds do better. Such details may be obtained for the asking. Even in the south, where mules are bred in preference to horses, an increased production of first class animals should find a ready market abroad although the mule is not used on the continent to the extent that it is used here.

OLD EQUIPAGE APPLIED IN WAR TODAY

Although detachable rims with flat feet for gun-carriage wheels, such as are used in the present European war, have been considered of recent development, essentially the same device was used by the British during the Crimean War. At that time the arrangement was only crudely worked out and consisted merely of movable rails attached to the wheels in such a manner that a large bearing surface was afforded on the ground. With wheels fitted with these feet, it was possible for the British to push their equipment trains over marshy or uneven ground, which in many instances would have otherwise been impassable. The detachable treads which have enabled the Germany artillery to introduce 11 inch howitzers, weighing many tons, on the battle field, are not different in principle from this improvised apparatus used by the English years ago, although the Krupp engineers have been given credit for them as a new invention. The principal difference in the modern device is that it is detachable.

Vehicles with steel-tired wheels will be prohibited in the principal parts of Paris after the first of January, according to a traffic ruling promulgated recently. The result of the order has been that many wagons and carriages fitted with the passing type of tires have been remodeled to meet the requirements. Those vehicles which are still using metal tires are being compelled to drive slowly.

WORKING AT TOP SPEED TO FILL ORDERS

"The American Carriage Company of Kalamazoo, Mich., is experiencing a run of prosperity all out of proportion to that of the majority of industries throughout the middle west," says the Press of that city. "Business at the plant not only is good, but is the best, in fact, that the concern has had in recent years.

"Never has the company received so many orders for sleighs as it has the present season. As a result it has had to work the full force of employees at top speed to take care of the orders that have poured in from every section of the United States where there is sleighing.

President Frederick W. Myers said that last month the company made the largest shipment of sleighs it ever made at any one time. There were 400 separate parcels in the lot.

THE WAR AND THE HORSES

Though the exportation of American trotting horses to Europe has nominally ceased since the war broke out, it is not unlikely that France and England, as a result of the war, will shortly have more of our trotters than ever before. A large percentage, and probably a very large majority, of all the horses now being purchased here for the armies of Europe carry more or less trotting blood, and a great many of them are trotting bred through both sire and dam. Few persons who are not in close touch with horse breeding fully realize the extent to which trotting blood has become infused in the horse stock of the country in the last 40 years. Until the craze for heavy draught horses took possession of the farmers nearly all of them raised trotting bred horses and used them for farm work. Horse buyers and other observers say that most of the light horses on American farms today are largely trotting bred, and this is almost equally true of express and delivery horses and various other types found in cities, towns and villages throughout the country. Active, hardy, level headed and intelligent, the typical cross-roads trotter is as apt as his Yankee owner at any kind of work that comes along, and the European buyers are taking thousands of such horses for cavalry, artillery and transport service.

Walter Baker, who is in close touch with the situation, says that both French and English buyers of cavalry horses show a preference for those about 15 hands high, with plenty of substance and deep, full middles, weighing in the neighborhood of 1,000 pounds. Horses as small as 14.3 hands are as acceptable as any others, he says, if they have the weight and quality.

Switzerland is the latest of the European nations to recognize the fact that the United States has more good cavalry horses than any other country in the world, Russia perhaps excepted. The peaceful little republic in the Alps is sending one of its army officers here on the quiet to buy remounts for eventualities.

AN "UNDESIRABLE" EMPLOYEE

Some firms have been endeavoring to help Belgian refugees by offering them work in their shops. The Autocar tells an amusing story of a well-intentioned house which did so to the satisfaction of everybody at first. A day or two later the foreman of the shop was asked how the Belgian refugee was getting on. Said the foreman, "Don't speak of him; he is one of the troubles of my life." "But why?" he was asked. "The shop is in a ferment over him," was the reply; "he is a remarkably quick and efficient worker, and gets through almost three times as much as his fellow workmen, who are trade unionists. Of course, he cannot speak a word of English, and the men cannot speak a word of French or Flemish, so that they are unable to point out to him that he is doing far more work than they are normally prepared to do." The men are about equally divided between patriotic sympathy for the unfortunate refugee and rage over the amount of work he gets through. The refugee is an unusually large man, and scarcely amenable to rough measures.—London Cabinet Maker.

THE HORSE "COMING BACK"

Increasing Use of Carriages Among Well-to-do Commuters

Dwellers in the large cities may or may not be able to see many signs of the "return" of the horse-drawn carriage. If they live in the center of the city and seldom go out of the congested districts they may think the horse has altogether and forever lost his old-time popularity.

But residents of suburban towns have noticed, or will notice, when their attention is called to the fact, that within the last year more traps, depot wagons and similar vehicles are being used than for some years past. It will be observed that many

well-to-do commuters, with businesses in the cities, when they step off platforms of their suburban stations, proceed to enter, not an automobile, as has been heretofore most usual, but a light carriage drawn by a handsome, silky coated horse.

Sometimes this vehicle is brought to the station by a servant or a groom, but more often by the wife, son or daughter of the home-coming business man. Frequently, too, we may see in the carriage a pair of rosy cheeked, country bred children, who have come along to greet "papa" in advance of the rest of the family.

There is something so near human about a horse that he seems to fit in more appropriately with family affairs than a mere machine. There is a "sociability" about a horse which we find in no other animal, unless it be the dog, and it is no wonder that in the family, where not only men, but women and children as well, are the units, the companionable horse should be preferred to the insensate automobile.

FOREST NOTES

Only 7½ per cent. of last season's 400 fires in national forests of Utah, southern Idaho, western Wyoming, and Nevada caused losses in excess of \$100.

Virginia uses more wood for boxes and crates than any other state, followed by New York, Illinois, Massachusetts, and California, in the order named.

Those familiar with the eastern mistletoe only have no idea of the great losses due to this parasite in the forests of the west, where it counts next to fire and insects in the amount of damage done.

In parts of the west where trees are scarce, sage brush is used for fuel. In Nevada the large main stems are trimmed by Indians at \$3 a cord and delivered to the user at about \$6.50. Sage brush burns rapidly and is rather dirty, but produces good heat.

A log raft containing one million feet of cedar, said to be the largest ever floated on the Pacific, recently made the trip from British Columbia to Puget Sound. It was 100 feet long and 70 feet wide; it stood 15 feet out of the water and 20 feet under.

Forest fires in British Columbia covered more than 300,000 acres during the past year.

During the first two year forest officers have killed nearly 9,000 predatory animals, more than three-fourths of which were coyotes.

The arboretum established at Washington in Rock Creek Park, through co-operation between the forest service and the District of Columbia, now contains 1,200 trees, comprising 92 different species.

There were 400 fires this year on the national forests of Utah, southern Idaho, western Wyoming, and Nevada, or 15 more than in the most disastrous season of 1910. Yet the cost of extinguishing them was only one-third and the damage only one-thirtieth of that of the earlier year. The difference is due to better organization now, and to more roads, trails, and telephones.

LABOR, POLITICS, NATIONALITY

The executive committee of the Civic Federation, wage-earners group, has 16 members, of which seven are Irish by name. What fellows those Irish are to edge to the front when the game is politics. It is a natural talent.

CAR SHIPMENTS IN 1914 TOTALED 138,250 CARLOADS

At a recent meeting of the directors of the National Automobile Chamber of Commerce it was reported that the shipment of automobiles from factories of this country in the year 1914 reached the tremendous volume of 138 250 carloads, each car usually containing from two to six complete automobiles and in some cases more when the machines were taken apart, to a greater extent than is ordinarily the case. This is about 14 per cent. greater than the cars required for the shipping of automobiles in the year 1913 and is easily one of the most important items of traffic in high grade manufactured articles handled by the railroads, whose earnings on these shipments are now estimated at upwards of \$15 000,000 per year.

The traffic committee also reported that the traffic department had conducted a meeting of the association's representatives at Detroit, January 20, at which all details of freight classification relating to the various kinds of self-propelling vehicles were carefully gone over and that this matter was further considered at a meeting with the uniform classification committee of the railroads at Chicago, January 25.

The department is taking a keen interest in further proceedings before the Interstate Commerce Commission on the proposed extra charge by railroads for placing cars on factory sidings. This service has always been considered as included in the freight rate on automobiles as well as on all other kinds of freight, and it is expected that the N. A. C. C. and all other shipping interests will resist to the utmost any effort to charge more for placing cars on terminals provided on private property than if the manufacturers made use of the railroads' own terminals, which are purchased and maintained at great expense to the carriers and would certainly have to be enlarged many times if all shippers used them.

Another matter that the traffic department is strongly resisting is a suggestion by some of the southern railroads that automobiles be accepted for shipment only when tops are removed or that a higher rating be charged; also a requirement that automobiles must in all cases be covered when shipped and that detachable parts must be removed and packed in iron-bound boxes.

GAIN OF \$939,194 IN KELLY-SPRINGFIELD PROFITS

The Kelly-Springfield Tire Co., which closed its fiscal year December 31, 1914, reports a net increase of more than 100 per cent. The gross profit for the year increased \$939,194, the net income being \$1,215,143. During 1913, the income was but \$559,543. Liberal reserves have been made for bad and doubtful accounts receivable and the inventories of merchandise and materials which increased \$563,757 during the year have been priced at cost with crude rubber at less than the market prices prevailing at the end of the year. Out of the earnings a sinking fund of 2 per cent. has been set aside for dividends on the 6 per cent. preferred stock.

Gross profit	\$2,203,761.00	\$1,264,567
Operating and administrative expense..	1,014,015.73	716,189
Net operating income.....	1,189,745.67	548,378
Other income	41,874.36	43,376

Total income

\$1,215,143.71	\$559,543
----------------	-----------

The balance sheet of the company, as of December 31, 1914, shows assets as follows: Cash, \$380,414.81; notes and accounts receivable of respectively \$114,302.31 and \$533,832.78, less reserve for bad debts and discounts of \$134,846.02, total \$513,289.07; inventories at cost, \$1,795,365.33, less the deferred charges to operations of \$28,335.72 makes the current assets, \$2,717,404.93.

Liabilities are as follows: Accounts payable, \$61,099.32; accrued charges, \$49,428.13; dividends and interest payable, \$143,049, making the current liabilities, \$253,576.45; 50-year sinking

fund 4 per cent. income debenture bonds, \$270,000; capital stock, \$8,665,400; sinking fund for redemption of stock and bonds, \$201,537.94.

PHILADELPHIA VEHICLE BUILDERS

The regular monthly meeting of the Carriage and Wagon Builders' Association of Philadelphia, was held at the Hotel Hanover, Twelfth and Arch Streets, on Friday evening, January 15.

Informal talks on subjects pertaining to the vehicle trade were given by several members of the association. L. L. Woodward, treasurer of FitzGibbon & Crisp, Inc., Trenton, N. J., was a visitor at the meeting and told the Philadelphia builders how things are done in the New Jersey capital. Mr. Woodward extended a cordial invitation to the members to visit his factory, which is one of the oldest and busiest in the State.

A theatrical benefit was given under the auspices of the Philadelphia association on the evenings of February 1 and 2. It was generously patronized by the members and their friends, the proceeds going into the funds of the vehicle drafting school conducted under the supervision of the Carriage and Wagon Builders' Association.

DECREASE OF \$71,500 IN ROLLS-ROYCE PROFITS

Profits of the Rolls-Royce, Ltd., London, Eng., decreased \$71,500 in 1914, compared with the previous year. A dividend of 10 per cent. was recommended instead of the 20 per cent. in 1913. The loss in earnings and lower dividend rate were due entirely to the war. Net profits in 1914 were \$384,255 against \$455,920 in 1913. The dividend of 10 per cent. was earned three and one-half times over.

The company has been exceptionally prosperous in past years, and in the last eight years and eight months has paid out in dividends a sum equal to the entire capital subscribed by the original shareholders.

The situation caused by the war was saved to a large extent by the acceptance of orders for ordnance, which while yielding little profit, kept the factories running and the men employed. The production of motor chassis has already recovered to half the maximum before attained.

TOP BUGGY STILL WITH US

The automobile is everywhere, but—common belief notwithstanding—what has it "crowded out"?

Not the horse. Throughout the country at large he is as plentiful as ever—just as cheap when you have to sell him, just as costly when you are out to buy. Not even the top buggy. For it appears, according to a report of the Western Retail Implement, Vehicle and Hardware Dealers' Association, that 2,200,000 buggies—the largest number on record—were made and sold in the United States last year.

Yesterday's luxuries are today's necessities. Has electricity put the gas companies out of business? On the contrary, more gas than ever is consumed, which means that millions now enjoy as a matter of course light that their fathers could with difficulty afford. A new invention rarely crowds out an older. It only spreads the latter over more of the world.—N. Y. World.

AUGUST SCHUBERT WAGON CO. PURCHASES GEAR COMPANY PLANT

The August Schubert Wagon Co., of Oneida, N. Y., announces that it has purchased the entire vehicle, gear, body and carriage trimming business of the Schubert Bros. Gear Co., including good will, and will continue the business together with its own.

BIG ORDER FOR TRAILERS PLACED BY FRENCH GOVERNMENT

A foreign war order for 350 motor truck trailers at \$1,256 each, has been received from the French government by the Troy Wagon Works Co., Troy, O. France is the third of foreign countries now at war to buy Troy truck trailers for use in the present struggle. Russia and England placed orders some time ago and deliveries already have been made to these nations. The Russian shipment was sent via Vancouver, the Pacific and Siberia.

The latest purchase was made through a commission in this country and was the outcome of demonstrations made with trailers in London by C. A. Geiger, president of the wagon works company, who has been abroad since late in November.

Shipments are to be started at once and completed within three months. The trailers are to be equipped with "army escort" bodies and are expected to be used behind motor trucks just bought in this country.

The Troy company is said to be the originator of the motor truck trailer idea, the developing of which required over three years.

"The trailer operates on the principle that a truck can pull from three to four times as much as it can carry at the same cost," says W. F. Jolley, sales manager of the company. "It took a long time to get to its present state of perfection because of the engineering difficulties to be overcome. We had to build a vehicle that would stand high speed; that wouldn't whip from side to side; that wouldn't jar the truck engine; that would track right with the truck and would back into narrow places and turn sharp curves.

"We believe the trailer will revolutionize motor truck transportation and that is the view of many large truck makers. The war has done much for both the truck and trailer business on this side of the water."

NEW YORK CITY WOULD LIMIT TRUCK SIZE

The Mayor's Central Committee on Street Traffic and Safety, New York City, met Feb. 8 at Police Headquarters to offer suggestions for making the city streets safer and for handling traffic more efficiently. Commissioner Woods said he was convinced that speeding motor trucks were one of the chief dangers, and offered the suggestion that these vehicles should be equipped with a governor to keep down their speed. The committee offered some fifty suggestions, one of the most drastic of which was that offered by Inspector Meyers in limiting the size of motor trucks and sight-seeing automobiles. He favored a law prohibiting such vehicles from exceeding 24 feet 6 inches in length, 7 feet 6 inches in width, and 12 feet 6 inches in height. He favored increasing the license tax on sight-seeing automobiles from \$10 to \$100 and wanted them kept off Fifth Avenue and Broadway in the rush hours.

GRANT MOTOR CO. LEASES BUILDING

The Grant Motor Co., Findlay, Ohio, has leased the buildings formerly occupied by the Finding Table Co., which will give them about 40,000 square feet of additional room. Automobiles will be finished at this place. It will also be the shipping point of the factory product. In a few weeks the company will begin to turn out fifty of its new sixes per day. A trainload will be sent to California.

PHILIPPINE AUTOMOBILE AND TIRE IMPORTATIONS

The results of the Payne tariff of 1909 (which admitted United States products to the Philippines free of duty) are apparent in the statistics for the succeeding years. During the year terminating June 30, 1912, 349 motor vehicles were im-

ported, valued at \$535,309, while the continuation of free imports raised the figures for 1912-1913 to 624, valued at \$886,710. At the end of 1913 there stood registered 2,562 motor vehicles of all kinds—1,567 pleasure cars, 294 trucks and 701 motorcycles. Imports of pneumatic tires and inner tubes for the fiscal year 1912-1913 represented \$180,923. The principal sources of supply were the United States, \$111,588; France, \$67,773, and England, \$1,448.

WAR ORDERS KEEP CLEVELAND PLANTS BUSY

Authentic information in Cleveland financial circles discloses an order received by the White Co., from the Russian government for 500 two-ton and 500 three-ton trucks, at an estimated cost of something over \$2,000,000. White company officials, however, have maintained secrecy regarding their foreign business.

The Peerless plant has been busy several weeks on a continuous order from the British government for an unstated number of trucks. Shares of the Peerless Motor Car Co. have developed a much stronger demand in the Cleveland market and it was inferred that the company had increased its weekly output for early shipment. Stock of the company has risen from a weak market around \$15 a share to a strong market at above \$20 a share.

The activity of the allied governments in placing orders for war munitions and supplies is coincident with the completion of arrangements by J. P. Morgan & Co., of New York, to act as representatives of the British government in this country.

ELKHART CARRIAGE COMPANY MAKING AUTOMOBILES

The Elkhart (Ind.) Carriage and Manufacturing Company is placing two entirely new chassis on the market this season. These are a four, model 40, and a six, model 50. In point of design these chassis are practically the same and differ only in the number of cylinders and in various dimensions. Each carries four body styles—two-passenger roadster and four, five and seven-passenger touring cars.

In the new Pratts will be found a Continental motor. Brown-Lipe gearset, Timken axles and Spicer shafts and joints. The model 40 motor is 4½ by 5¼ and the wheelbase 122, while in the 50 the engine dimensions are 3¾ by 5¼ and the wheelbase 132 inches.

Body lines and equipment are the same for both vehicles. In the latter will be found Gray & Davis cranking and lighting. Atwater Kent ignition, Kellogg tire pump, bumper, extra rim, etc.

RECEIVER FOR COLUMBUS CONCERN

F. C. Myers, secretary of the United States Carriage Company, Columbus, Ohio, was appointed receiver for the company by Judge Dillon. He gave \$50,000 bond.

Application for the receivership was made by Mrs. Katherine Myers, wife of C. F. Myers, president of the company. In her petition, filed through Attorney Q. R. Lane, she said she holds a \$6,000 note of the company, due and unpaid.

The company has been selling motor cars, hearses and other vehicles on notes, the petition recites, and the outstanding notes and obligations now amount to \$90,000. Danger of insolvency is alleged.

RECEIVER FOR WAL-RIKE COMPANY

C. L. Armstrong has been appointed receiver for the Wal-Rike Pony Vehicle Company of St. Paris, Ohio. According to reports the company has assets of \$23,000 and owes \$15,470. The application for receiver was filed by E. M. Baker, president of the company.

FIFTY YEARS IN THE SAME FACTORY

Mr. Leonard C. Nichols, president of Chauncey Thomas & Co., Boston, Mass., celebrates this month, the 50th anniversary of his connection with that firm.

Mr. Nichols began his career as a painter in 1861, in Roxbury, Mass., then a separate city. In 1874 he left Roxbury and went to Boston, entering the employ of Chauncey Thomas & Co. as a foreman painter. He was admitted to partnership in the firm in 1876, and at the death of Mr. Thomas, in November, 1898, he was made president and treasurer of the company.

He is still remarkably active in every way and can be seen every day personally supervising some difficult piece of work in one of the various departments of the factory. He said recently, in answer to an inquiry: "I expect to be around here for many years to come." The Hub, with many others, hopes his expectations may be fulfilled.

RECEIVER FOR TWOMBLY CORP.

F. W. Stelle has been appointed receiver for the Twombly Car Corp., New York City, with the power to continue business or to close up any of the establishments of the company. The appointment was made on application of D. Stuart Dodge, president and financial backer of the company, who alleges he advanced \$114,439 to provide funds for pay-rolls and other expenses. He is the largest creditor. Outside of his claim, which amounts to \$468,238, the liabilities will not exceed \$10,000, to about seventy creditors. The tangible assets, it is asserted do not exceed \$35,000 aside from the patents and interests in contracts with W. I. Twombly, the inventor, which are of uncertain value.

It is expected that a new company will be reorganized with new capital.

THE WORD "BUGGY"

It may be of interest to know that, according to a contemporary, the word "buggy" is not the Americanism it is so commonly considered. Both the vehicle and its name came originally into English from India. In the Hindostani language "bagghi" means a light traveling cart, and the word buggy fairly well represents the sounds of the Hindoo characters. "Bagghi" is derived from the word "bag," meaning to be in motion, or to be moving. After leaving India the word has had different meanings; in England it often indicates a light vehicle with two wheels, but in America it has never meant anything but a fourwheeled vehicle.

TO TRY MICHIGAN BUGGY CO. OFFICIALS

All criminal cases against former Michigan Buggy Company officials will be heard during the February term of circuit court at Kalamazoo, Mich. Prosecuting Attorney Frank Ford and his assistant, Stephen Wattles, have carefully prepared the cases against the officials and are now ready to have the cases go before the court.

The men charged with fraudulent dealings in connection with the sale of stock and general conduct of the defunct company who will be tried are: Frank B. Lay, Jr., and George B. Lay, both vice-presidents; Frank B. Lay, Sr., and M. H. Lane, founders of the concern.

ADDITIONAL BOND DISPENSED WITH

In the case of Harry W. Quackenbush vs. Harry H. Elwood et al., United States District Judge Hollister made an order Jan. 19 directing that H. H. Haines, receiver of the New Decatur Buggy Company in this case, need not give an additional bond in the sum of \$15,000 to stay the decree entered pending appeal, in view of the fact that he is already under bond in the

sum of \$30,000, with the American Bonding Company as surety, as receiver. The Buckeye Wheel Company and other creditors of the receiver took exceptions to the order.

GOVERNMENT WANTS TRUCK ESTIMATES

The Secretary of the Treasury has issued a call for sealed proposals for furnishing the various executive departments in Washington with gasoline and electric trucks during the fiscal year beginning July, next. The bids will be opened at 2 o'clock, March 10, by the general supply committee. The number of trucks required is not given. Strict specifications have been issued to which bidders must closely adhere.

Detailed information, together with proposal blanks, can be obtained upon application to the General Supply Committee, Auditor's Building, Washington, D. C.

MILLER RUBBER CO. EXPANSION

The Miller Rubber Co., by a two-story, fireproof, brick addition to their plant, have provided for an increase of 1,000 tires in their daily output. A three-story 40 x 110 feet warehouse is being built, also a 50 x 100 extension to the rubber drying room. The additional factory space, including a new shipping department built on adjoining property recently purchased, will total 272,905 square feet, or about 6½ acres, and a 2,000 horsepower plant is also being installed for operation purposes.

DONT'S FOR RETAILERS

Don't buy too heavily or unwisely.

Don't neglect collections.

Don't ignore notes, drafts or letters.

Don't extend credit unless the step is absolutely imperative.

Don't forget to insure your store or warehouse, or any other buildings. Insure live stock if you have any.

Don't talk with the calamity howling bunch. Our country is all right. Get busy, and you will get business.

ENGLAND KEEPS TANNERIES BUSY FOR ARMY

Field Marshal Earl Kitchener, Secretary of State for War, issued a decree on November 24, in London, England, reserving all the hides of full-grown cattle for military purposes. A special company having charge of the leather business of the country is organized. All the tanneries will be operated in connection with this company, receiving from it their quotas of hides which they are to tan for the army.

WILL MANUFACTURE HUBS

A \$40,000 corporation has been organized at Shawano, Wis., for the manufacture of hubs. The incorporators are W. C. Landon and T. S. Davis of Wausau, and George T. Harding of Merrill. Mr. Harding for some time has been connected with the Andrew Kaul Company, of Merrill, who also manufacture hubs. He will be the manager of the new concern.

PREVENTING MILDEW ON CANVAS

To prevent mildew on canvas, soak it in bluestone water, or if the mildew is already present, coat the parts well with ordinary soap and rub on powdered chalk, or whiting. A solution of corrosive sublimate, well weakened with water, will also prevent mildew, but owing to its poisonous nature it is best to use the former method.

Authentic records show that cinders, from a forest fire in the tree tops in northern Washington this fall, were carried a distance of 20 miles.

ATTEMPT THAT FAILED

The following from Commercial Motor of London, makes interesting reading:

When the French Government decided, a few months ago, to purchase American motor lorries, it gave Lieutenant Lumet full powers to act in its name. In civil life Lieutenant Lumet is head of the Technical Committee of the Automobile Club of France, and also founder and chief engineer of the club's modern laboratory near Paris.

The attempt of an American trust to capture the French officer is an incident worth relating. The first intimation that American manufacturers received of the French intention to purchase army lorries, was a letter from a big steel corporation in the east, stating that the entire business was in their hands, and inviting the motor manufacturers to send sample lorries to their establishment. The individual manufacturers fell to the plot, nearly a score of them sending an exhibition lorry to the steel works. It was expected to get Lieutenant Lumet to visit this commercial-motor show and place his orders through the steel corporation, with, as it was afterwards learned, a net profit to the intermediary of more than three-and-a-half million francs. But the scheme was frustrated by the refusal of the French envoy to be tied down. Never having before been in America, Lieutenant Lumet was so anxious to see American factories that he ran direct to Detroit, without even stopping for a look in at the exhibition specially prepared for him in the east. Thus all the French orders were placed direct with the American factories, without the aid of any intermediary whatsoever. The firms which have received the orders are Packard, Pierce-Arrow, Kelly-Springfield, White, and a small number from the Jeffery Company. Two and three-ton models have been purchased, these being in each case the firm's standard models with practically no modifications. The types selected accord, as far as possible, with the French subsidy machines, but in order that there should be no delay in delivery it was decided to overlook the smaller differences. All the models have four-cylinder motors, but they comprise worm, bevel and chain drive. Four-wheel-drive types have not been purchased abroad.

DON'T DO IT

Among a certain proportion of retail implement dealers—and we hope a small one—a habit prevails of deducting the small discount allowed on most bills for payment within a given time, long after the bill has become due. In justice to the jobber this is manifestly unfair, and the honesty of the action is very questionable. The discount allowed for cash within a number of days specified upon the bill is simply a premium for the prompt payment of that bill, and lack of promptness in settlement causes the discount clause to become null and void. Every jobber wants the dealer to avail himself of the opportunity to take the discounts allowed for various payments within the time specified, but once the discount date has expired the dealer has no more legal or moral right to deduct a discount than he would have to rifle the safe of the jobber. It is not a natural privilege of the retailer to deduct discounts from a bill past due, and it leads to unnecessary correspondence and loss of confidence in the dealer by the wholesaler. To credit himself with the few dollars comprising the discount may seem innocent enough to the retailer, but it is not business when the date has passed, and is a habit which should be unanimously condemned.

NOISES ARISING FROM BUCKLING METAL

A form of noise that is annoying and at the same time difficult to trace is that caused by the slight buckling of a sheet metal part under vibration, a portion of the sheet being curved just enough to allow it to snap back and forth and make a noise in

doing so. The remedy is either to eliminate the curve, if that be possible, or to stiffen the place so that the buckling cannot occur.

ISN'T IT ODD THAT GOWEN SHOULD WANT A JOB?

Fred H. Gowen must be the absolutely best known man to the dealers in vehicles the country over. How could it be different when he has crossed the continent no less than 54 times in the successful prosecution of business?

How is it possible such force and dynamic business energy should not be selling Moyer buggies as has been the case for 29 years, with a sales record that all pointed to as a mark to try for?

Well, it is just as you would think it out if you didn't know. Neither party left the other, but the business has been the sole cause. Perhaps, soon, there will be no Moyer buggies, or not in quantity, at any rate, to engage the work of a man of Gowen's class.

It is not often that such a man is free to accept a proposition as a sales manager. Who is there among this class who has either so wide or so personal an acquaintance among vehicle dealers the land over? The true answer is none. We suppose the mere announcement that Mr. Fred H. Gowen may be addressed at his Little Falls, N. Y., home on the subject of a business engagement will interest buggy builders, or auto builders, or tire makers as much as any business news we could print.

HOW TO CLEAN BRASS

To clean brass furnishings or to remove fly spots or tarnish from them they should be boiled for a few minutes in a solution of one ounce of alum to every pint of water. After boiling they should be polished by some brass polish or with a dry cloth. This will remove tarnish where other means fail.

CHANGE IN STUDEBAKER MANAGEMENT

W. B. Pond, who for some years has been works manager for the Studebaker Corporation, has tendered his resignation and will engage in other business. W. W. Austin has been appointed general superintendent, and M. R. Kavanagh, assistant general superintendent.

395,000 INCREASE IN HORSE POPULATION

According to the report of the United States Department of Agriculture, the increase in the number of horses in the United States in 1912 was 58,000. **In 1913 the increase was 395,000.** This hardly looks as if the horse had joined the "passing show."

Have you ever stopped to consider how much effort, how much expenditure of energy, of brain and money—how much cumulative force of advertising it has taken on the part of the manufacturer to bring one solitary customer into your store, trained to call for his product by its name?

When a screwdriver slips from the screw slot, dip it in fine emery and it will hold.

F. A. Lane, who for twenty-five years was the leading local salesman in the carriage department of Studebaker's New York repository, was killed while crossing the tracks to take a train for New York at his home station, West Englewood, N. J., in January. He was struck by an express and instantly killed. He leaves a wife and three sons, who are actively engaged in business in different parts of the country. Mr. Lane was born at New Haven, Conn., and the interment was at Amherst, Mass., Mrs. Lane's old home. The funeral was largely attended.

Trade News From Near and Far

BUSINESS CHANGES

Gus. Goetsch, of New Ulm, Minn., has sold his wagon shop and business to W. J. Konkal, of Shakopee.

The implement and buggy business of Chas. A. Leach, Maquijota, Ia., has been sold to J. H. O. Kemp.

Fred Albright has sold his interest in the wagon business of Scheunert & Albright, at Waupun, Wis., to Ernest F. Miller.

The interest of John Durr in the buggy and implement business of Martin, Davenport & Durr has been taken over by Walter Martin and J. W. Davenport.

Henne & Meyer Hardware Company, in business at Rockdale, Tex., have bought out M. & J. D. Hefley Company, implement and vehicle dealers, at Cameron, Tex., and will open a branch at Cameron.

John H. Atchison, of Galesburg, Ill., who has now a half interest in the Galesburg Buggy Co., will take over the Edmundson interests in that firm and will assume the management of the business.

W. W. Embry, of the Cynthiana Carriage Company, of Cynthiana, Ky., has sold his interest in the business to his two partners, J. W. and W. R. Leek. He retired from the business on November 1, but announcement of the change has just been made.

George Wilcox, of Dodgeville, Wis., has sold his interest in the Dodgeville Wagon Works to his partners, William H. Mitchell and Gus Hendrickson. The firm will now be known as Mitchell & Hendrickson. Mr. Wilcox expects to move to Minnesota in the early spring.

NEWS OF THE TRADE

The Turnbull Wagon Co., of Toledo, Ohio, with factory at Defiance, has increased its capital from \$300,000 to \$400,000.

The Fred Wilking Carriage Company has been organized at Marietta, Ohio, by Fred Wilking and others. The capital stock is \$10,000.

Dr. Delson, of Charlotte, Mich., will erect for his wagon factory a brick building. The building will be two stories high and basement.

The Mays Manufacturing Company, of Leslie, Ark., has a contract from the Fort Smith Wagon Company, to make 4,000 hubs to be used by the French government.

The Geo. E. Nissen wagon works, of Winston-Salem, N. C., has resumed operations with a full force, but the plant will be operated only four days a week for the present.

The Lull Carriage Company had sold 4,000 sleighs up to January 1, with some orders still coming in. President H. Alexander Crawford says 1914 was one of the best years of the sleigh business in general and the "Kalamazoo kind" in particular.

The Auto Top and Seat Cover Company is the name of a new concern located at Kalamazoo, Mich. S. G. Brink is at the head of the concern. He has been associated with the Velie Motor Vehicle Company, Moline, Ill.; Auburn Auto Company, Auburn, Ind.; Eckerat Carriage Company, Auburn, Ind.; Page Brothers Buggy Company, Marshall, Mich., and for the last two years he has had entire charge of the trimming department of the Michigan Buggy Company.

LIFE OF HORSES ON THE FIRING LINE

That the average life of a horse on the firing line in France is about ten days was the astonishing declaration of a British army officer identified with the remount department. Horsemen were prepared to hear of unexampled wastage after reading about the havoc wrought by modern artillery and machine guns, but this report indicates such slaughter as had not been dreamed of in this country.

In the civil war in this country the wastage of horses was at the rate of about 500 a day in the Union army, and the service of a cavalry horse under an active commander then averaged about four months. During his Shenandoah Valley campaign Sheridan required 150 fresh horses a day, and in eight months the cavalry of the Army of the Potomac was remounted twice, nearly 40,000 horses having been required.

If the British officer's estimate of the wastage is not wide of the mark, it is a foregone conclusion that before the carnage ends there will be such a shortage of horses as Europe has never seen. As most of the animals now in the field were commandeered from farmers and others who had been using them in agriculture and industry, and this demand, added to that of the war, will, it is believed, seriously affect the price of horses the world over during the next few years.

MOTOR VESSELS VIA PANAMA CANAL

A contract for building two Diesel motor vessels, to ply between Christiania and Pacific ports from the Panama Canal north as far as Victoria, British Columbia, has just been concluded between Fred Olsen, of Christiania, one of the largest ship owners in Scandinavia, and Burmeister & Wain, ship builders of Copenhagen. Specifications are: Length, 425 feet; width, 55 feet; depth, 38½ feet; net tonnage, 11,000; speed, 11 miles; wireless equipment; 12 first-class cabins; contract price, \$1,876,000—one of the vessels to be ready for service early in 1915, the other toward the end of the same year. It is claimed that these vessels are to be the largest Diesel motor vessels yet built.

TO MANUFACTURE TRUCKS AND AUTOMOBILES AT COLUMBUS, OHIO

The Hub Motor Truck Co., Columbus, Ohio, has been incorporated with a capital of \$300,000 to manufacture and sell all kinds of automobiles. It is planned by the organizers to open a factory in Columbus for the manufacture of the Hub Motor trucks, basic patents for which are held by the Hub Motor Truck Co. of America, a New York corporation. The incorporators of the Columbus company are T. C. Haney, J. L. Herpich, J. B. Bass, R. Wilke and J. J. Chester. A truck is now being built by the Kaiser Motor Car Co.

LOZIER PLANT BRINGS \$1,000,000

A joint bid of \$1,000,000 for the property of the Lozier Motor Car Co., made by Harris Bros. Co. and Frank Bros., of Detroit, and Theodore Friedeberg and Charles Shongood, of New York, was accepted Feb. 5 by Lee S. Joslyn, referee in bankruptcy. The purchasers bought the property for speculation purposes. The terms are \$200,000 cash, half payable within 90 days and the other half within six months. The remaining \$800,000 is to be paid within a year.

OBITUARY

George H. Smith, Reading, Pa., carriage and wagon manufacturer, died December 29, aged 58 years.

Elisha Braddish, 82, a former manufacturer of carriages, died suddenly Jan. 28 at North Dana, Mass. He was a native of Holden, Mass.

Max Robinson, one time manager of the Savannah Carriage & Wagon Co., and later organizer of the Auburn Wagon Co., died at Martinsburg, W. Va., last month. At the time of his death he was the manager of the latter concern.

Charles Lempke, 86, a pioneer carriage and wagonmaker of Detroit, Mich., died Feb. 6, following an illness of four weeks. Mr. Lempke was born in Prussia, and came to Detroit when 24 years old. He established a wagon factory on Gratiot Avenue, which he continued until 10 years ago when he retired.

Max Robinson, 53, general manager of the Auburn Wagon Co., Martinsburg, W. Va., died Jan. 31 as the result of stomach trouble. Mr. Robinson was born in Fernandina, Fla. He had been connected with the Auburn Wagon Co. for many years and was formerly southern agent for the Travelers' Protective Association. His widow survives him.

Valentine Linn, widely known in New York as a manufacturer of carriages and automobile bodies, whose factory was for half a century located at 53 Bergen Street, New York City, died last month at his home, Nineteenth Avenue and Eighty-second Street, Bath Beach, N. Y. He was born in Germany seventy-four years ago. A son and daughter survive.

Charles Goldner, 62, died Feb. 5, at his home in Detroit, Mich., from the effects of a stroke of apoplexy. Mr. Goldner was born in Berlin, Germany. His parents immigrated to the United States when he was eight months old, locating in Detroit. Mr. Goldner was engaged in the brick business for a time and later with his father embarked in the carriage and wagon manufacturing business. The business located at Goldner and Michigan Avenues was a thriving one and son succeeded father in conducting it. Surviving him are six children.

S. S. Parmelee, president of the S. S. Parmelee Co., Macon, Ga., died January 27, at his winter home in Washington, D. C. Mr. Parmelee went South in 1865 and commenced business in Augusta, Ga., but in 1877 went to Macon and operated a vehicle business under the name of R. H. May & Co., which was a branch of an Augusta firm of the same name. A few years later he took over this branch and changed the name to correspond with his own. In 1905 the concern was incorporated under the style of the S. S. Parmelee Co., the members of the corporation being S. S. Parmelee, president; A. S. Hatcher, vice-president; J. A. Dunwoody, secretary and treasurer. The concern, which is a large jobber of vehicles, harness, automobiles, motorcycles and accessories, will continue as heretofore in charge of Mr. Hatcher and those associated with him.

Nathaniel S. Ketchum, 75, died at Marshalltown, Ia., on Jan. 16, of Brights disease. Mr. Ketchum, at the time of his death was senior member of the State railroad commission and was a pioneer business man of Marshalltown. Mr. Ketchum accepted an offer to become general manager of the Moline Wagon Company, Moline, Ill., in 1878. He remained there two years. When he returned to Marshalltown he, and others, organized the Ketchum Wagon Company and capitalized it for \$100,000.

Mr. Ketchum was the first president of the company, which started operations Jan. 1, 1881. Mr. Ketchum sold out his interests in 1890 and engaged in the jobbing business, and in this he was succeeded by his son in 1904 when he was elected to the position of State railroad commissioner which he held at his death.

INDEX TO ADVERTISERS

Backstay Machine and Leather Co..... 40
 Cargill Co., The..... 3
 Carter Co., Geo. R..... 40
 Central Mfg. Co..... 40
 Columbus Bolt Works.....4th cover
 Correspondence School of Carriage and Motor Carriage
 Drafting 2
 Dowler, Chas. L..... 40
 Du Pont Fabrikoid Co.....3d cover
 Eccles, Richard, Co..... 3
 Fairfield Rubber Co..... 3
 Gifford, John A., & Son..... 3
 Hotel Cumberland 39
 Keystone Paint & Filler Co..... 3
 Lawson Co., F. H., The.....2d cover
 Masury, John W., & Son.....2d cover
 Miller Bros. 40
 Mulholland Co., The..... 40
 National Spring & Wire Co.....2d cover
 Payne Co., E. Scott..... 40
 Pierce, F. O., Co.....3d cover
 Porter, H. K..... 3
 Sheldon Axle and Spring Co..... 39
 Sherwin-Williams Co., The..... 1
 Sidney Mfg. Co., The..... 40
 Standard Oil Cloth Co., Inc., The..... 4
 Standard Wheel Co.....4th cover
 Stewart-Mowry Co.....4th cover
 Stinson Mfg. Co., The Edward.....3d cover
 Technical School for Carriage Draftsmen and Mechanics.. 3
 Virginia and North Carolina Wheel Co..... 40
 West Tire Setter Co..... 2
 White-Quehl Mfg. Co..... 40
 Wilcox Mfg. Co., D..... 1
 Willey Co., C. A..... 2

WANTS

Help and situation wanted advertisements, 1 cent a word; all other advertisements in this department, 5 cents a word; initials and figures count as words. Minimum price, 30 cents for each advertisement.

PATENTS

Patents—H. W. T. Jenner, patent attorney and mechanical expert, 606 F St., Washington, D. C. Established 1883. I make a free examination and report if a patent can be had and exactly what it will cost. Send for circular.

WANTED

A line of regular buggies, also a storm buggy, to handle on commission, also to get in touch with the commission, salesmen, a special feature that is making good. Unanimously approved by all users; buggies equipped are buggies easy sold. Address, C. B. Moore, 401 West 11th St., Rochester, Indiana.

FOR SALE

Old-established carriage repair shop; best stand in town; one square from courthouse and next to largest livery stable in town; established 27 years. Great opportunity and bargain to right person. Reason for selling, sickness. Address W. H. Wagner, 211 Dayton Ave., Xenia, O.

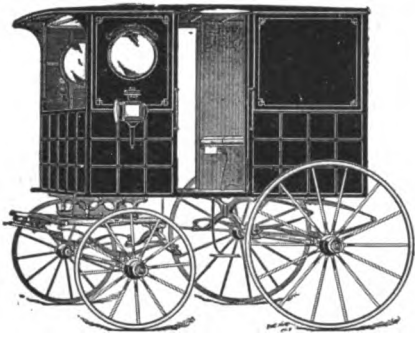

No. 112.—Milk Wagon.

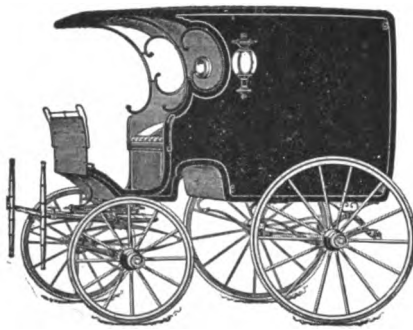

No. 111.—Altman Wagon.



No. 113.—Grocery Wagon.

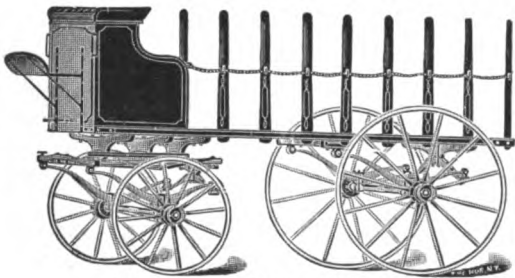

No. 122.—Flour Truck.

Electrotypes

of the vehicles presented on this page will be forwarded on receipt of

75 cts.

for each cut, to any address. Postage prepaid.

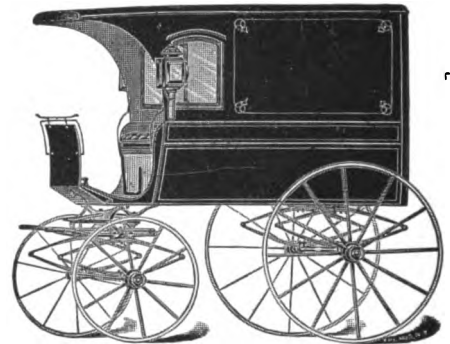

No. 115.—Delivery Wagon.

Catalogue

containing nearly 200 illustrations of carriages, wagons, sleighs, and miscellaneous cuts will be sent upon application.

Trade News Publishing Co.
24-26 MURRAY ST.
NEW YORK

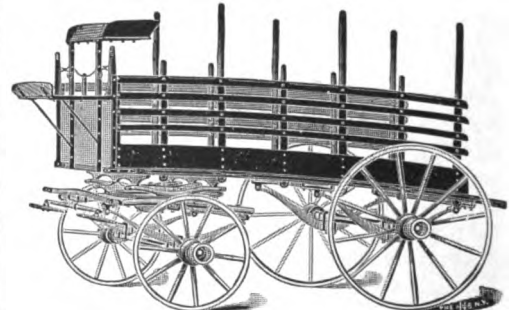

No. 117.—Merchandise Truck.

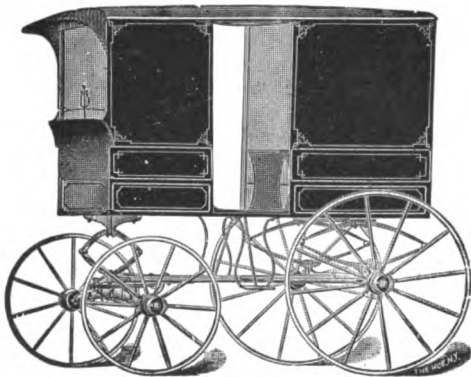

No. 116.—Milk Wagon.



No. 114.—Delivery Wagon.

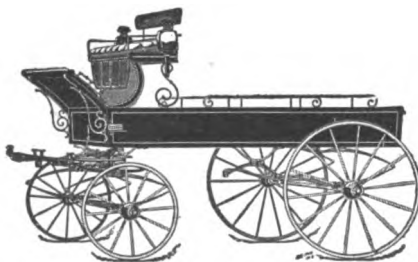

No. 124.—Delivery Wagon.



No. 118.—Ambulance.

SHELDON AXLES AND SPRINGS

**For Horse-Drawn and Power-Propelled
Vehicles of All Kinds**

JUST ENOUGH BETTER THAN OTHERS TO BE NOTICEABLE

When you specify "Sheldon" you are not experimenting with experiments, but are getting Axles and Springs with years of manufacturing experience back of them—Axles and Springs that are selected for important work where conditions make reliability supremely important

SHELDON AXLE AND SPRING COMPANY, WILKES-BARRE, PA.

LARGEST AXLE AND SPRING FACTORY IN THE WORLD

HOTEL CUMBERLAND

NEW YORK

BROADWAY AT 54TH STREET

Near 50th St. Subway Station
and 53d St. Elevated.

"Broadway" cars from Grand
Central Depot pass the door,
also 7th Avenue cars from
Pennsylvania Station.

New and Fireproof

Best Hotel Accommodations
in New York at Reasonable
Rates.

**\$2.50 with bath
and up**

European Plan

All Hardwood Floors and
Oriental Rugs

**Ten minutes' walk to
40 Theatres**

Excellent Restaurant
Prices moderate

Send for Booklet



HARRY P. STIMSON, Formerly with Hotel Imperial

Only New York Hotel window-screened throughout

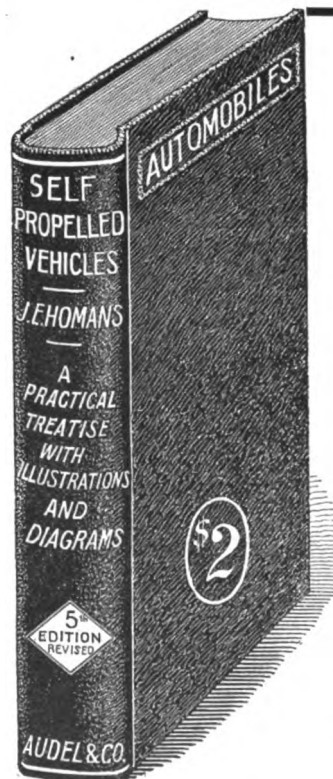

"Self-Propelled Vehicles"

Fifth Edition, Revised.

A practical treatise on the
theory, construction, opera-
tion, care and management of
all kinds of Automobiles.

By

JAMES E. HOMANS, A.M.

Contains 608 pages and
upwards of 500 illustrations
and diagrams, giving the es-
sential details of construction
and many important points
on the successful operation
of the various types of motor
carriages driven by steam,
gasoline and electricity.

This work is now the ac-
cepted standard, explaining
the principles of construction
and operation in a clear and
helpful way. This book will
be sent postpaid to any ad-
dress in the United States,
Mexico or Canada upon re-
ceipt of \$2.00.

Address

Trade News Publishing Co.

24 Murray Street, New York

BUSY BUYERS BRIEFS

CHARLES L. DOWLER
CARRIAGE AND WAGON HARDWARE
108 North Third St., Philadelphia, Pa.
CUSHION MANUFACTURER
Pure Stearic Acid Candles. Wheel Stock. Snow
Flake Axle Grease.

Sidney Metal Buggy Seats and Metal Bodies

The Best in the World
Every Seat Guaranteed
THE SIDNEY MANUFACTURING CO., SIDNEY, O.

Automobile and Carriage Leathers, Leather Welts and Gimps

All Kinds of Leather Specialties
WRITE US FOR PRICES
THE GEO. R. CARTER CO.
CONNERSVILLE, IND.

MULHOLLAND BUGGY SPRING

Reduces weight of springs one-half.
Made in one size only but will fit bodies
of all widths.
Write for further particulars and prices.
THE MULHOLLAND CO. DUNKIRK, N. Y.



LINED

White's Brazing Sleeves

For applying Rubber Tires
Send for Samples.



UNLINED

WHITE-QUEHL MFG. CO.

431 E. Pearl St.
CINCINNATI, OHIO

STEEL SEATS AND BODIES

Not a Weld, Joint or Seam

CENTRAL MANUFACTURING CO.
CONNERSVILLE, IND.

AUTOMOBILE Bodies AND CARRIAGES IN THE WHITE

Estimates Furnished on Special Designs

MILLER BROTHERS
Amesbury, Mass.

E. SCOTT PAYNE CO. Carriage and Automobile HARDWARE

Horse - Shoers' Supplies
362-364 North Gay St., Baltimore, Md.

AMBULANCE CONSTRUCTION COMMISSION

Chairman: Sir FREDERICK TREVES, Bart., G.C.V.O., C.B., F.R.C.S.

THE COMMISSION WILL AWARD
PRIZES HAVING THE VALUE OF
£2000 IN ALL FOR IMPROVEMENTS
IN FIELD MOTOR-AMBULANCES

The Wellcome Bureau of Scientific Research, acting on the suggestion of Mr. Henry S. Wellcome, Founder of the Bureau, has offered the sum of £2000 (to be divided into a FIRST prize of £1000, a SECOND prize of £500, a THIRD prize of £300) for the best designs of ambulance-bodies which shall fit a standard chassis. Lesser prizes will also be awarded for minor improvements in connection with motor-ambulance construction generally.

The Competition is open to Citizens of all Nations

The awards will be made after June 30, 1915, the last day for receipt of designs

*Full details of the conditions to be fulfilled, together with the names of Members of the Commission and other particulars, may be obtained from The Secretary, Ambulance Construction Commission, 10, Henrietta Street, Cavendish Square, London, W., England.

Finishing Welts
Bindings
Auto Straps
Shaft Straps

**Backstay Machine
& Leather Co.**
Union City, Ind.

Patent Valances
Patent Prop Blocks
Cut Leather to
pattern in all grades

BENT RIMS

Hickory Second Growth and Forest Hickory
All Grades

OAK—STAR BRAND

SPOKES

Second Growth Hickory—Finished and Club Head

SUITABLE FOR ALL VEHICLES, INCLUDING AUTOMOBILES

VIRGINIA AND NORTH CAROLINA WHEEL CO.

8 Bridge Street, New York City

RICHMOND, VIRGINIA

Please mention "The Hub" when you write

"TRIUNE" COLOR VARNISH

Is strictly a Varnish Product possessing color with the power to Cover in one Coat. It works as freely as straight varnish and will "flow," "level," "rub," "moss" and exhibit in general full durable qualities and working properties.

THREE QUALITIES IN ONE PRODUCT

1—Color. 2—Power to cover in one coat. 3—Straight varnish working properties and qualities. Nothing like enamel or gloss paints. Different, distinct.

Sole Manufacturers

F. O. Pierce Company, New York City

12 West Broadway

The Edward Stinson Mfg. Co.

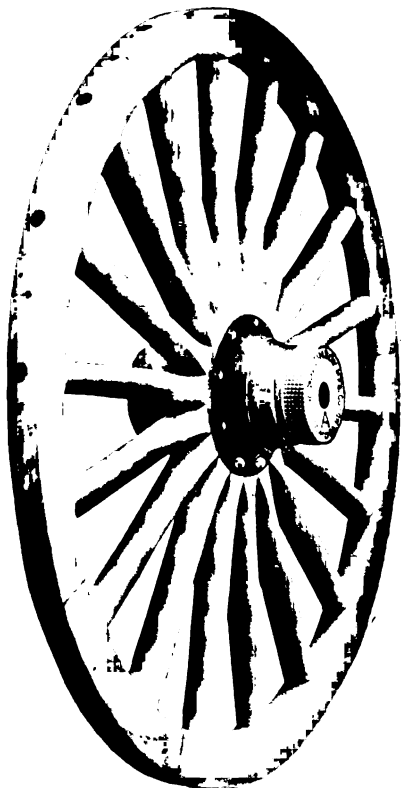

Manufacturers of
Warner, Sarven,
Plain, Compressed
Band and Star or
Kenney Hub

WHEELS

All Sizes

Write for price list
No. 18

327-325 Guilford Ave.
BALTIMORE, MD.

U.S.A.

SPOKES, RIM & HUBS

How Many
Hides
Has
A Cow?

ONE for nature's demands, but several for tanners who split or peel the cow's hide into several thin, fleshy sheets or "Splits," coat them and then emboss one side of each, and call it "Leather." The lower splits are poor apologies for leather and have not the strength and wear-ability of



MOTOR QUALITY

Guaranteed Superior to Coated Splits

coated with the same material as that used on "splits," but re-enforced with a sturdy cloth backing, which adds much to the strength, pliancy and durability of FABRIKOID Motor Quality. Two years' severe tests by leading automobile and carriage makers result in the adoption by them of this superior grade of artificial leather. Our country-wide advertising campaign is telling your trade and prospective buyers the reasons why they should insist on FABRIKOID Motor Quality upholstery in place of inferior coated splits.

Upholster with FABRIKOID Motor Quality,—settle the covering material wisely and finally,—Use FABRIKOID.

For samples and prices, write to Department 269.

DU PONT FABRIKOID CO.

Wilmington, Delaware.

Canadian Branch: Toronto, Ontario.

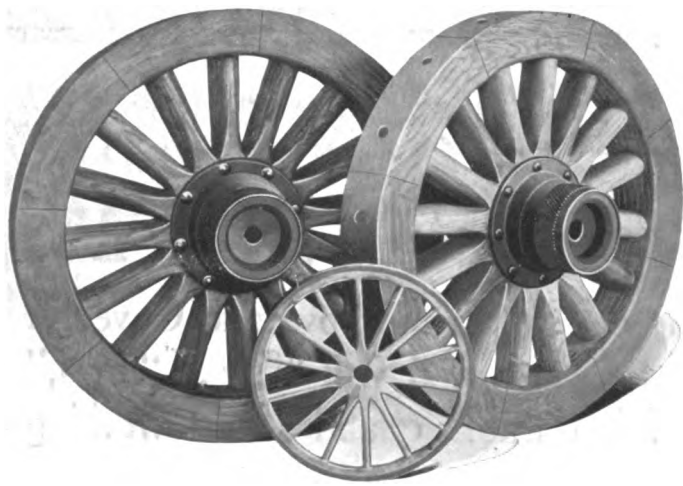

Standard Wheel Co.

Terre Haute, Ind.

Manufacture all kinds and
all sizes of Wheels for
Carriages, Wagons and Motor Vehicles

Quality First

THIS TRADE MARK MEANS MUCH TO VARNISH USERS

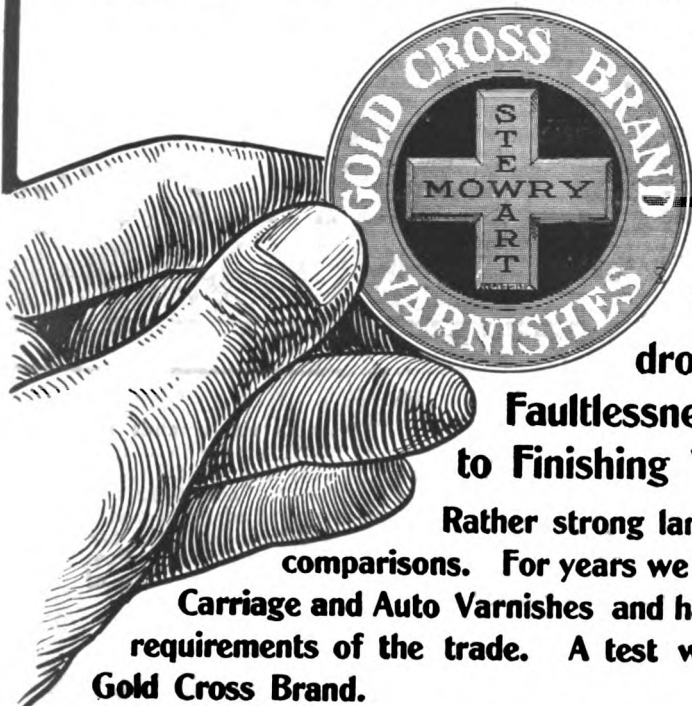

It signifies Quality. It is placed
only on the best line of Varnishes
we make---our Gold Cross Line.
We stake our reputation on every
drop that bears this brand. It implies

Faultlessness, and has no superior from Japan
to Finishing Varnish.

Rather strong language—but we can prove it; and we court
comparisons. For years we have been making the most complete line of
Carriage and Auto Varnishes and have put some very intensive study into the
requirements of the trade. A test will convince you of the superiority of the
Gold Cross Brand.

STEWART-MOWRY CO., CHICAGO, ILL.

Skewed Shaft Couplings

**Regular or Oval Patterns
For High Arched Axles**

Furnished in rights and lefts for any height of arch. Oval Axle
Clips $\frac{5}{8}$ or $\frac{3}{4}$ width to match Oval Couplings. Bolts, Clips,
Couplings, Carriage Hardware and Special Forgings

Catalogue "H" and Prices on Application

COLUMBUS BOLT WORKS, Columbus, O.

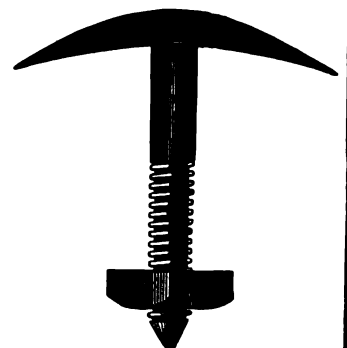
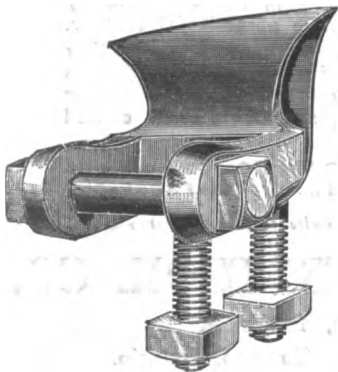

The Hub



TRADE NEWS PUBLISHING COMPANY
24-26 MURRAY ST. NEW YORK.

JOHN W. MASURY & SON

Originators of

Superfine Coach and Automobile Colors

ACKNOWLEDGED THE STANDARD FOR FIFTY YEARS

And Manufacturers of

Fine Carriage and Automobile Varnishes

New York

Chicago

Minneapolis

Kansas City

"BLACK VELVET" CUSHION SPRINGS

Manufactured Only by the

NATIONAL SPRING AND WIRE COMPANY

ALBION, MICH. WINDSOR, ONT.

THE SPRING OF QUALITY.



SPRING or SOFT EDGE CUSHION FRAME

For Ruggies or Other Vehicles. Built of the Highest Grade of Steel Wire.

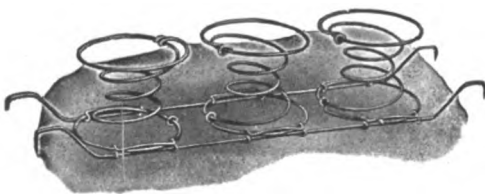

STRIP FOR WOOD OR BOX FRAME

THE F. H. LAWSON CO.

CINCINNATI, O.

Manufacturers of

Metal Buggy Seats

FLEUR DE LIS PATTERN

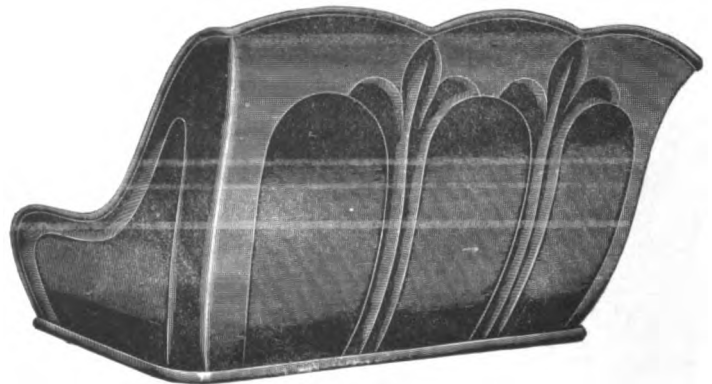

NEW STYLES—ALL SIZES

STRONGEST—NEATEST—BEST

No Solder Used

YOUR VEHICLE SELLS WHEN EQUIPPED WITH

LAWSON'S METAL SEATS

Write for Prices

SHERWIN-WILLIAMS
VEHICLE FINISHES

A PRODUCT FOR EVERY PURPOSE, PRODUCING DISTINCTIVE RESULTS

S-W METAL PRIMERS S-W BODY AND GEAR UNDERCOATINGS
S-W Q. D. COLORS S-W COLOR VARNISHES
S-W FINISHING VARNISHES

EFFICIENT IN QUALITY AND UNIFORMITY

The SHERWIN-WILLIAMS Co.

CLEVELAND CHICAGO NEWARK MONTREAL LONDON, ENG.

WILCOX **F** FINE
FINISHED
FORGED



No. 1963

**Carriage Hardware
and Gear Irons**

Write us for Catalogue No. 11B

The D. Wilcox Mfg. Co.

**MECHANICSBURG,
CUMB. CO., PA.**

Please mention "The Hub" when you write.

WILLEY'S COLORS

The **RECOGNIZED STANDARD**



C. A. WILLEY CO.

COLOR GRINDERS

and Manufacturers of Specialties in

CARRIAGE, AUTOMOBILE AND CAR

PAINTS

COLORS, VARNISHES, ETC.

HUNTER'S POINT, NEW YORK CITY

The WEST Hydraulic Tire Setter WILL CUT DOWN EXPENSE



Tires set cold in one minute. This machine saves time—does the work better and quicker, does a way with burned streaks. Only necessary to measure one wheel in a lot. Does not char the rim, and thus make the tire loosen prematurely.

Saves resandpapering of wheels. This machine is now increasing the profits of many manufacturers. Send for catalog and read about it.

WEST TIRE SETTER CO.,

ROCHESTER, NEW YORK

Established 1886

Correspondence School of Carriage and Motor Carriage Drafting

A thorough, practical tuition is given through this correspondence school. The theory and practice of construction, bookkeeping, perspective. Many men now hold good positions through taking the courses of instruction.

Principal, **THOS. MATTISON,**

Hillside Avenue, Bitterne Park,

Southampton, England

Author of "The Coach Body Makers' Guide," \$3.00; a practical treatise on "The Suspension of Carriages," "Bookkeeping," and other carriage building works.

WHAT IT IS

The American Harness and Saddlery Directory

The 1914 Edition

An extra painstaking revision of the names (and other information as below) constituting the Retail Harness Trade, has been completed for this year's issue of the Directory, and we think the work is so important and worthy that the

1914 Price is \$5 Per Copy

and it is very moderate for what is offered in a work that is

Indispensable for Reference

for copying of addresses, and for all purposes usual in a directory.

Just a Sketch of Its Contents

The list of the **WHOLESALE** and **JOBGING TRADE** is so arranged as to make it convenient to separate the association members from those not so recognized.

The **RETAIL HARNESS MAKERS** of the United States and Canada comprise the principal part of the Directory, arranged by State, Town and County, and in the large cities, the street and number is given. Those rating (approximately) over \$1,000 are marked.

A list of **HARNESS DEALERS** as distinguished from retail harness manufacturers, is also given. The value of this list to those who solicit the vehicle, implement, hardware and department stores will be readily appreciated.

A list is also published of Export Commission Merchants, giving the class of merchandise they handle.

PUBLISHED BY

THE TRADE NEWS PUBLISHING COMPANY

PUBLISHERS OF "HARNESS"

24-26 MURRAY ST., NEW YORK

PORTER'S BOLT CLIPPERS
 "Easy" "New Easy" Allen-Randall



To Cut 5-16, 3-8, 1-2, 5-8, 3-4 inch.
H. K. PORTER, EVERETT, MASS.

CARRIAGE—WAGON—AUTOMOBILE
 AND SPECIAL
DROP FORGINGS
 QUALITY—THE
 BEST

Richard Eccles Co., Auburn, N. Y.

PROMPT
 SERVICE.
 WRITE FOR CATALOG.
 SEND BLUE-PRINTS OR MODELS
 FOR OUR QUOTATIONS—IT WILL PAY YOU!



THE FAIRFIELD RUBBER COMPANY

Manufacturers of

**Carriage Cloth, Imitation Leather,
 Automobile Cloths, etc.**

FAIRFIELD, CONNECTICUT

KEYSTONE BLACK FILLER
 MAKES A PERFECT
ROUGHSTUFF

For Automobile Bodies and Parts

It fills the pores of Metal and Wood perfectly. Sand-
 papers easily and produces a fine smooth surface
 that DOES NOT CRACK, SCALE NOR PEEL.

POMEROY & FISCHER, New York
 Selling Agents to Vehicle Trade

KEYSTONE PAINT AND FILLER CO., Muncy, Pa.

Cargill Service

has brought to the Cargill
 Company more Vehicle
 Catalogues than are made
 by any other printing
 house in America.

Cargill Quality
 is bringing The Best Autom-
 obile Catalogues to our plant for
 Complete production—watch
 for our imprint in the Season's
 best books.

THE CARGILL COMPANY

DESIGNERS
 ENGRAVERS



PRINTERS
 & BINDERS

Grand Rapids, Michigan

Carriage Mechanics

Desiring to improve their present
 Condition should attend the

TECHNICAL SCHOOL

FOR

Carriage Draftsmen and Mechanics

SUPPORTED BY THE

Carriage Builders' National Ass'n

The object of the School is to teach men to design
 vehicles and make working drawings, and to otherwise
 facilitate their work in the shop. Only those men em-
 ployed in carriage or automobile building or their acces-
 sory trades are admitted to its privileges.

The classes are conducted in three divisions, viz.: Cor-
 responding, Day, and Evening. The former is open during
 the entire year, while the day and evening classes are in
 session only from October 1 to April 1.

The tuition is moderate.

For prospectus and full particulars, write to the instructor,
ANDREW F. JOHNSON,
 20 West Forty-fourth St.,
NEW YORK CITY

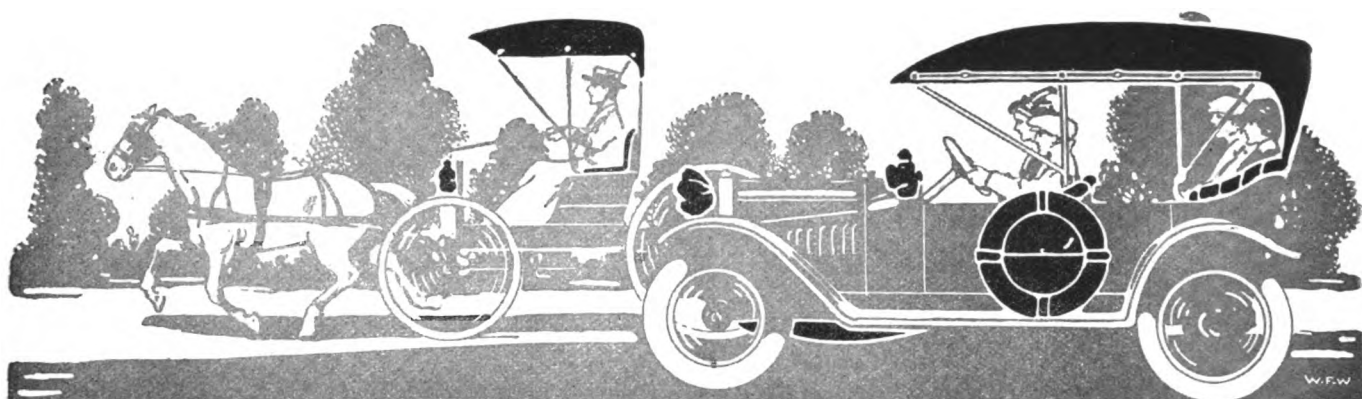

Learn More About The Leading Leather Substitute

Every carriage and automobile manufacturer—every manufacturer of carriage and auto accessories, storm curtains, aprons, lamp covers, tire cases, trunks, etc., should get and examine samples of

MERITAS

LEATHER CLOTH

Only by seeing the goods—by testing them—by noting the handsome, durable, non-cracking finish and the fine line of colors can you appreciate the high quality we have attained in the manufacture of a serviceable leather substitute.

There are styles, colors and finishes in MERITAS LEATHER CLOTH suitable for every carriage and auto trimming and upholstery purpose.

It can be had in muslin, duck and drill; dull or glazed; smooth or grained; in black and colors.

Sample book on request—write now and know more about the leading leather substitute.

Write
for
sample
book of
MERITAS
LEATHER CLOTH
NOW

The Standard Oil Cloth Co., Inc.
320 Broadway, New York

THE TRADE NEWS PUBLISHING CO. OF N. Y. Publishers of THE HUB

J. H. WRIGHT, *President* G. A. TANNER, *Secretary and Treasurer*
24-26 MURRAY STREET, NEW YORK

Other Publications of Trade News Publishing Co.:

HARNESS (monthly).....per year, \$1.00
AMERICAN HARNESS AND SADDLERY
DIRECTORY (annual).....per copy, \$5.00

THE HUB is published monthly in the interest of employers and workmen connected with the manufacture of Carriages, Wagons, Sleighs, Automobiles and the Accessory trades, and also in the interest of Dealers.

Subscription price for the United States, Mexico, Cuba, Porto Rico, Guam the Philippines, and the Hawaiian Islands, \$2.00, Canada, \$2.50, payable strictly in advance. Single copies, 25 cents. Remittances at risk of subscriber, unless by registered letter, or by draft, check, express or post-office order, payable to the order of THE TRADE NEWS PUBLISHING CO.

For advertising rates, apply to the Publishers. Advertisements must be acceptable in every respect. Copy for new advertisements must be received by the 25th of the preceding month, and requests to alter or discontinue advertisements must be received before the 12th day of the preceding month to insure attention in the following number. All communications must be accompanied by the full name and address of writer.

FOREIGN REPRESENTATIVES:

FRANCE—L. Dupont, publisher of *Le Guide des Carrossiers*, 78 Rue Boissiere, Paris. Subscription price, 15 francs, postpaid.

GERMANY—Gustave Miesen, Bohn a Rh. Subscription price, 12 marks, postpaid.

ENGLAND—Thomas Mattison, "Floriana," Hillside avenue, Bitterne Park Southampton. Subscription price, 12 shillings, postpaid.

Entered in the New York Post Office as Second-class Matter

Dr. Rittman's Discovery

The discovery by the Federal Bureau of Mines of chemical processes in the treatment of petroleum which will both treble the output of gasoline and provide an abundant supply of products essential to the making of dyes and high explosives, for which we have hitherto had to rely on Europe, is especially interesting as a contribution to industrial economy. Rarely does invention or discovery come at so opportune a time for the relief of necessity.

It is interesting to note that these new discoveries are not the product of any corporation or group of interests that would put a check on their use by the people as a whole.

Unfamiliar as are the names of tuluol and benzol, they are the foundation of many industries of the first rank, and the German manufacturers, upon whom the world has hitherto been almost wholly dependent for both, have carefully cultivated the belief that they could be made only from coal tar and economically only in Germany. Such is not the case, it seems, and the Germans are confronted with the loss of one of their most valuable monopolies.

Gasoline, we knew well enough, could be extracted from our own petroleum, but only the biggest of our oil companies has been able to do the extracting really well. The Rittman process, it is stated, will put the "independent" refiners on an equality in this particular form of production, and the effect will be that they alone can double the present output—with the usual influence on prices.

The new processes have been patented, but in the name of the Government, and their free use will be permitted to all American manufacturers.

A Valuable Work Well Done

Last month we published a portion of the new cost system of the C. B. N. A. The second and final installment appears in this issue.

The vehicle trade will find this work of the cost committee of the C. B. N. A. a source of profitable education in the matter of determining the production expense in their manufactories. The committee has accomplished a task which will surely result in far-reaching benefits to the trade, and Messrs. Sayers, Ebrenz, Dort and Fullreader, who formed the committee, are deserving of all credit for a work ably performed and of greater value to the trade than anything yet achieved by the National organization.

Will the Jitney Bus Do It?

There is now an opportunity for students of transportation facilities to do considerable speculating on the advent of the jitney bus in the field of public carriers, and its ultimate relation to the removal of the many ills and discomforts now prevalent in the crowded transportation centers of our country.

It would seem, from the numbers engaged at present in operating jitney buses, that they are just what the public has wanted in the way of transportation facilities. Serious consideration is due this new means of public conveyance, however, as the foothold already gained in some cities may be taken as an indication of future demands on various municipalities.

Some means of regulation of competition and some provision for the liabilities of the owners and operators in case of accidents should certainly be considered by every municipal government, in anticipation of granting privileges of such a character as will undoubtedly affect not only the traveling public, but the already franchised transportation companies.

That the jitney bus fills a place of its own in many

localities cannot be denied, but as a real factor in the solution of the problems now a part of nearly every city's government, it appears that its ultimate importance is yet a matter for speculation and study.

100,000,000

An expert statistician of the census bureau says that at 4 o'clock in the afternoon of April 2 the population of the United States of America will be 100,000,059. He has computed carefully from verified rates of increase, and, if neither figures nor figurers lie, there is no escape from his conclusion.

There is nothing materially significant in the exact figure of 100,000,000. But if it is not significant the additional decimal is at least striking. It serves to bring home a sense of the nation's vastness and power. A hundred million human beings is a number far beyond visualization, but the mere bigness of the number is startling.

Only three nations, Great Britain, China and Russia, have greater populations. And none of these possess a land so well adapted for its greatness of numbers. The British total includes its colonies of many races in all parts of the world; the Chinese are overcrowded in a comparatively small area; while the Russia domain is in large part poorly adapted for human habitation. There is still much room for the United States to grow, and to grow with comfort to the people.

MORE LIVE STOCK THAN A YEAR AGO

Government Statistics Contradict Reports That Prices Will Reach Unprecedented Figures

For the first time in many years, information collected by the department shows that all classes of live stock in the United States are increasing in numbers. Thus the real facts contradict, absolutely, sensational reports that prices for meat and shoes would rise to unprecedented figures in the immediate future. It has even been said that a Government statistician predicted meat at 50 cents a pound and shoes at \$10 a pair within the next two years. Such a prediction, the real Government statisticians say, is quite unwarranted.

On January 1, for example, the number of beef cattle showed an increase of 3.4 per cent. over the number a year ago, and an actual increase of 1,212,000 head. Hitherto the number of beef cattle in the United States has declined steadily since 1910. There are also more milch cows in the country than last year, the increase being 2.5 per cent., or in numbers 525,000. Swine, however, showed the greatest increase of all classes—9.6 per cent. On January 1, 1914, there were only 58,933,000 swine in the country; on January 1, 1915, 64,618,000. This is accounted for by the fact that the production of swine can be increased more rapidly than that of other classes of live stock and consequently an enlarged demand can be met more readily.

The prediction of 50-cent meat and \$10 shoes was accompanied by the declaration that France alone has taken from America nearly 300,000 horses within the last five months and that the other countries at war have drawn upon our resources in the same proportion. The facts are that more horses were on the farms of the United States on January 1, 1915, than there were a year before, the increase being 233,000 head, or 1.1 per cent. So far from France alone having taken 300,000 horses from us, the total exports since the war began have certainly been much less than 100,000 and very likely not over 75,000. Since there are approximately 25,000,000 horses altogether in

the United States, the drain on account of the war is scarcely alarming.

It is, in fact, pointed out by Government statisticians that the market value of farm horses has actually declined to such an extent that the average is now about \$6 a head less than a year ago. This decline is most noticeable in the cotton States and in those States which make a business of breeding horses for sale in other sections. Mules have declined even more than horses, their value being now \$11.50 per head less than a year ago. The explanation is to be found in the depression on account of the cotton situation in the South, which is the great market for mules. An improvement in this respect will do much to restore the demand for horses, so that Government specialists, while ridiculing the notion of a horse famine, are convinced that farmers will find it profitable to use good work mares for breeding more stock.

As for hides, the situation is not quite so clear, but even here there has been much gross exaggeration. From two-fifths to less than one-half of the leather used in this country is imported, about 25 per cent. of the foreign hides coming from Argentina, 15 per cent. from Canada, 11 per cent. from Mexico, 8½ per cent. from European Russia, and 7½ per cent. from France. Since the outbreak of the war importations have shown a certain falling off, those for September, 1914, for example, being only 34,000,000 pounds, instead of 45,000,000 pounds the year previous. There is, however, little reason to suppose that this decrease will be permanent or of sufficient importance to create any real scarcity. Since the great bulk of the imported hides comes from countries that are not at war, shipments are not interfered with in any way, and the only new factor to be considered is the possibility of an increased demand by the warring countries.

It is believed, however, that the United States is now in a better condition to face such a situation than for years past. The tide, it seems, has turned. Instead of live stock steadily decreasing year after year, this year for the first time, as has been said, all classes show an appreciable increase. Including horses, mules, milch cows, beef cattle, sheep, and swine, there were on January 1, 1915, 7,712,000 more farm animals in the United States than on January 1, 1914. The increase in the total value was \$78,024,000, or 1.3 per cent. It is quite true that this increase is not yet proportional to the increase in population, which is approximately 2 per cent.; but the fact that there is an increase, that the tide seems definitely to have turned, is regarded as a sufficient answer to alarming exaggerations and misleading figures.

LEATHER PRICES AFTER THE WAR

An English Tanner of Wide Experience Says There is Not Much Hope of a Decline

A staff writer in the Shoe and Leather Record (England) writes from Warrington and district that a well-informed local tanner, whose words should carry weight, said some people looked for a slump in prices directly after peace was concluded or when peace negotiations were in progress. That, he considered, would be found to be quite wrong. For some time after the Franco-Prussian war there was a big trade to be done, and that, in my informant's opinion, will be the case after the close of this war. It is thought in this district that prices will remain somewhere in the region of their present figure for possibly a couple of years after the end of the war, when they will gradually recede to a more reasonable limit. The production of leather has been enormously reduced in many countries owing to the war, and almost the only two countries tanning to any extent are England and America. All others have had their stocks depleted and many of them have had no opportunity to produce more. When peace reigns again these countries will want leather from somewhere, and if there are only two sources of supply, what will happen appears to be obvious.

AUTOMOBILE ROW AT THE PANAMA EXPOSITION

Automobile row as it is presented in the Transportation Building of the Panama-Pacific International Exposition at San Francisco, provides a wonderful spectacle. Every kind and description of motor vehicle is on exhibition there and many of the types are startling in the extreme. The visitor will see so much to interest that it will take the better part of a day to make the rounds. Little cars, big cars and others are arranged in a striking manner and for a lover of motor vehicles to enter the exhibit without losing his heart to one of the hundreds of beautiful machines there, is an impossibility.

The Ford people have a big allotment of space and are using every inch of it to the greatest advantage. Every nut and bolt of this wonderful little car is shown before and after it is placed in position and owners who perhaps do not understand the makeup of this car will have the opportunity of their lives to learn. It is a difficult matter to pick any one exhibit as the best as each representative has put forth his best efforts to outdo his rivals in striking and instructive displays. Here and there a big touring car will rear its hood above smaller rivals only to lose its place for the moment to the rear of a cut-out chassis or the whirl of a car speeding along on rollers at a terrific pace.

Such well known cars as the Pierce-Arrow, Chalmers, Packard, Mitchell, Ford, Buick, Oakland, Kissel and Jeffery are much to the fore with beautiful displays, but they are by no means the only ones attracting attention of the thousands who daily throng the spacious row where the "gas buggies" have been installed. The sum represented by the machines on the floor will be a huge one. One exhibitor alone has placed a valuation of \$40,000 on the cars in his charge and this is only one of many. With hundreds of cars on display the value in dollars and cents is a hard one to compute.

The cars themselves and the necessary exhibits close at hand are not the only points of interest to auto enthusiasts. The big relief maps, covering hundreds of feet of wall space and showing the three greatest automobile routes in the United States are proving a wonderful attraction. Tiny incandescent lamps of various colors mark the big cities and towns along the routes and anyone can see at a glance just how to motor from New York to San Francisco, San Diego or Galveston to Minneapolis. The transcontinental road from New York to San Francisco is an immense affair and covers the entire area of two big ceiling borders. Nothing of its kind on such a scale has ever been attempted at other expositions and this part of the automobile exhibit is bringing forth a world of favorable comment.

Cars in every stage of completion will be found, some silent, others roaring as their engines are fed with "real gas" to show their points. Here a Ford will snort to a sudden start to be drowned shortly after in the roar of a big six cylinder. While the locomotive exhibit in the same building is a wonderful one, automobile row is holding its own with the monsters of the rails and every day brings some new features to one exhibit causing its rival to look about them for something still more startling and a trifle newer.

HORSES IN NEW YORK CITY

Recent Statistics Show the Number to Be Constantly Increasing

In an effort to stamp out glanders, perhaps the most insidious and dangerous disease that horseflesh is heir to, the state veterinary authorities, acting under the direction of the Commissioner of Agriculture, have just completed the first horse census ever undertaken in New York. Breeders, owners, dealers and horse fanciers generally will be interested in knowing that it discloses an equine population of 110,144 which is many times larger than the number of automobiles in the city, even including the dead ones, and probably is greater than the whole

number of motor vehicles in use in the state. The borough of Manhattan alone has 56,434 horses, and there are 36,184 in Brooklyn, 8,600 in the Bronx, 5,583 in Queens and 3,343 on Staten Island.

Experts have frequently tried to estimate the number of horses in New York, but it is believed that no one ever guessed up to the actual total as disclosed by the state census just taken. The late J. D. Carroll, treasurer and general manager of the Fiss, Doerr & Carroll Horse Co., fixed the number at about 100,000 a few years ago, and this turns out to have been a close guess, for despite the activities of the automobile makers and dealers the number of horses has kept increasing from year to year and is now probably 10,000 larger than it was when Mr. Carroll made his reckoning.

Besides counting all the horses the state authorities counted all the stables in the city and tabulated them as to character, sanitary condition, ventilation, ownership and number of horses, and then cross indexed these statistics by the card system, so that hereafter full information will be at hand concerning every important detail of the equine population.

Dr. H. D. Gill, who had charge of the canvass, says that the records just collected will be of inestimable value to the authorities in dealing with the problem of stamping out glanders. By a system of inspection and records not unlike those of the dairy farms now under state supervision the veterinarians expect to be able to locate at once all outbreaks of glanders and prevent the disease from spreading, as it has done in the past. Owners who fail to provide healthy quarters for their horses will, it is expected, be quickly singled out, and the officials will have authority to make them mend their ways or give up their horses. Stables in which repeated attacks occur will be fumigated, sterilized and put in thorough sanitary condition or else closed to the keeping of horses.

One of the important features of the new card index system is that it will enable the veterinary authorities to trace any particular horse from one stable to another, wherever he may go in the city, and thus guide the doctors in keeping watch of all animals with which a diseased horse may have come in contact. If necessary each stable where a glandered horse has been kept can be quarantined until its inmates have been tested for disease, thus cutting off the chances of communication to healthy horses.

Though the borough of Manhattan has 20,250 more horses than Brooklyn it has less than one-half as many stables. The borough across the bridges has, indeed, almost as many stables as all the rest of the city taken together. Its 36,184 horses are housed in 5,261 different buildings, while in Manhattan there are only 2,130 stables for 56,434 horses. The average number of horses in a stable is thus more than 26 on this side and seven on the other side of the East River. Staten Island, however, has more room for its horses than Brooklyn or any other borough has, the average there being less than three occupants to each barn. The following table, furnished by Dr. Gill, shows the records for the five boroughs:

Borough	No. Horses	No. Stables	Average
Manhattan	56,434	2,130	26½
Brooklyn	36,184	5,261	7
Bronx	8,600	1,216	7
Queens	5,583	1,167	4½
Richmond	3,343	1,306	2½
Totals	110,144	11,080	10

In connection with the new records of the city's equine inhabitants Dr. Gill and his associates are now putting into effect a system of identifying the horses by fastening a sealed band around the neck of each animal that is tested for glanders. The band carries a number, and in time it is expected that each horse in the city will be registered in this way, so that he can be located at any time and his history traced from the time he arrives in New York until he leaves the city.

ARMORED CAR AT THE AUTOMOBILE EXHIBIT, PANAMA-PACIFIC INTERNATIONAL EXPOSITION

Daily reports from the seat of the great European war are showing what an important part the armored motor car is taking in this great struggle of nations. No other vehicle has played or will play so vital a part in the struggle of empires now in progress and visitors to the Transportation Building at the Panama-Pacific International Exposition at San Francisco, will have an opportunity of seeing just how these speeding fighters are handled under fire.

A special car is now on its way to San Francisco in which is stored one of these fighting machines, and immediately upon its arrival at the exposition grounds will be placed on exhibition by the Jeffrey Company by whom it is manufactured. Accompanying the armored car is one of the latest type machine guns now being used by the British army with hundreds of rounds of blank ammunition with which to give practical demonstrations.

The car is bound to prove of more than ordinary interest to automobile enthusiasts because of the features it combines with that of its fighting qualities. The machine is what is known as a 4-wheel drive truck with double transmission, giving it a forward and backward speed of 30 miles an hour. The truck steers, drives and brakes on all four wheels and can be handled from either the front or rear steering gear. The double-transmission is a big feature of this car and its arrival is being awaited with great interest by those who are professionally or otherwise interested in motor vehicles.

The crowning feature of the truck's qualities is the turret in which the machine gun is to be mounted. In this steel tower, the gunners are fully protected from rifle fire and their elevation gives them a big advantage against an enemy on foot. The Jeffery concern has already shipped several of these cars abroad and they are now in actual use on the firing line.

R. L. Newton, in charge of the Jeffery exhibit, has also arranged a patriotic display of the beautiful machines on his floor. Three beautiful touring cars, painted in the national colors are in the foreground of the Jeffery exhibit and are attracting widespread attention.

The Jeffery concern, however, is not going to be allowed a clear field for honors among the automobile exhibitors and already the Buick, Chalmers, Packard, Pierce-Arrow and Ford cars are crowding to the front. The Ford people will probably have the biggest exhibit on the floor, and at the same time a striking one. The manufacture of the Ford will be shown in every stage, and the complete machine will be seen speeding along on rollers at top speed.

The big black and white Packard car, which forms the apex of that company's exhibit, now looks over "automobile row" from a big glass case. The car is a thing of beauty and is the center of attraction in that part of the Transportation Building. The Packard exhibit runs into many thousands of dollars and is one of the most complete of the exposition. The light blue roadster and limousine are proving magnets to auto fanciers, particularly the smaller car which has come into such favor recently.

The Buick exhibit is attracting its share of attention. There are seven cars in this exhibit, placing every Buick model on display. Fred Gross and George Dean of the Buick concern are making cut out chassis the feature of their exhibit. The valve-in-head specialty of the Buick is shown in a striking manner and the exhibit is one of the most instructive and interesting in the big hall.

Those visiting automobile row have also found much to interest them in the relief maps of the Mid-continental highway and the coast route. The former shows the automobile roads from Galveston to Minncapolis while the latter gives the route from San Diego to Seattle, taking in every town on the route and showing clearly just how to cover this long run with pleasure and little wasted time. Still another relief map, dotted with tiny electric bulbs shows the route from New York to San

Francisco. This map covers an immense amount of space and is one of the greatest things of its kind ever attempted. All these attractions will be found handy and instructive to automobile owners who are given to long journeys in their machines and aid in making this part of the exposition exhibits the greatest of all time. Every make of car will be found on the floor and every representative is striving to outdo his rival in the beauty of exhibit.

BOUGHT 75,000 HORSES FOR WAR

No Danger of Shortage, However, Says Expert—Big Demand Later

Warring European nations have bought and exported more than 75,000 horses from the United States, but there is no immediate danger that continued exports will cause an acute shortage of horses in this country, says G. A. Bell of the Bureau of Animal Husbandry, in the Agricultural Outlook.

"We could sell two or three times the number already exported without there being any appreciable shortage of work-horses," the statement adds. "The kind purchased are for the most part very mediocre animals, which would ordinarily sell for less than \$100 per head, and are a class of which we can well afford to be rid.

"The big demand for horses will probably occur after peace has been declared. At that time the countries, now at war, with the exception of Russia, will no doubt be very short of horses for their agricultural and other work. European Russia had, prior to the war, about 25,000,000 horses. This country and Russia together have 50 per cent. of all the horses in the world. A very large number of horses in Russia will be destroyed in the war and the remainder will, no doubt, be needed by Russia for her own agricultural and other work.

"The demands on the United States, which has one-fourth of the world's horses, will, therefore, be large and will probably continue for a number of years, for the rehabilitation of the depleted horse stock of any country is a slow process. This country, however, will be in a position to meet this demand."

AMERICAN HORSES FOR EXPORT

The world's stock of horses is 100,000,000, of which Russia has 25,000,000 and the United States over 24,000,000. Exports from this country during the four months September to December, 1914, totaled 75,000 horses. It has been feared by some that there would be such large numbers exported to the warring European countries as to cause an acute shortage of horses in the United States. The Department of Agriculture, however, sees no immediate danger of this, and says that we could sell two or three times the number already exported without there being an appreciable shortage of work horses. Those which have been shipped are mediocre animals, which ordinarily sell for less than \$100, and are of a class which we can well afford to be rid.

The big demand for horses will probably occur after peace has been declared, when they will be needed for farming. The demands on this country, which has one-fourth of the world's supply of horses, will be large, and will probably continue for a number of years. The United States will be in position to meet this foreign demand if farmers will breed their good mares.

KRAMER LEASES BAILEY PLANT

The Kramer Auto & Carriage Co., Lancaster, Pa., has been incorporated with a capital stock of \$5,000 by I. N. and G. R. Kramer, of Goodville, Pa., and Edward McLaughlin, of Lancaster, to manufacture vehicles and commercial automobile bodies. It has leased the former factory of S. E. Bailey & Co., on North Queen Street, Lancaster. Edward McLaughlin is president, and I. N. Kramer, purchasing agent.

MEMORIAL BUILDING FOR FANNY CROSBY

The Bridgeport Christian Union has inaugurated a movement to raise funds for a building to be erected as a memorial to the blind writer of hymns, Fanny Crosby.

This movement is of more than local or national interest. The fact that Fanny Crosby's hymns have been translated into all the languages of the earth, and have been sung in every country on the Globe, makes this matter of international interest.

Mr. E. W. Harral, president of the Fairfield Rubber Works, vice-president of the Christian Union, writes that it is the desire of the originators of this movement that all shall have their part in the project, no matter how small it may be.

Mr. Sankey, son of the singing evangelist, has heartily endorsed the project as have several of Miss Crosby's old friends. It will undoubtedly be a pleasure and a welcome privilege to all lovers of the blind writer's hymns, to have a part in the construction of a suitable memorial to one who exerted such a power for good among her fellow beings.

A building has been proposed, especially designed for the purpose of caring for men who need aid. It is to have many private rooms, a dormitory and other necessary adjuncts for the work of helping up those who have fallen, and to provide a clean, wholesome place for them to live in. Industrial features would also be incorporated and the building would be made self-sustaining.

Contributions may be sent to Egbert Marsh, treasurer of the Christian Union, care of the Bridgeport Land & Title Co., Bridgeport, Conn.

STUDEBAKER CORPORATION MAKES EXCELLENT SHOWING

According to the annual report of the directors of the Studebaker Corporation of South Bend, Ind., and its subsidiary companies for the year ending December 31, 1914, the net profits for the year derived from the regular business after the deduction of increased depreciation allowances and the payment of interest amounted to \$4,441,966.16. The net profits for 1913 were \$1,772,473.65. The 1914 profits therefore show an increase over the previous year of \$2,669,492.51, or 150.6 per cent. After the payment of regular dividends on preferred stock and the transfer to the special surplus account of the amount to be set aside therein under the terms of the corporation's charter, the balance of the profits of \$3,165,893.11 was added to the surplus, and this account showed a total credit as of December 31, 1914, of \$5,265,819.45. The special surplus account showed a balance of \$1,230,747.54.

The report states that the corporation's net profits gave it a return of 12.8 per cent. on the outstanding common stock after deducting the payment of 7 per cent. preferred stock dividends. This showing is against a return in 1913 of 3.1 per cent. Rather than use any of the profits for the payment of dividends on the stock, the directors believed it would be the wiser policy to devote the profits to the payment of debts and to the increase of the cash balance. Following this policy resulted in a debt reduction of \$4,168,978.98 and an increase of \$1,581,703.05 in the cash on hand, making a total improvement in this respect of \$5,750,682.03 for the year.

MARKS IN WOOD RECORD HEAVY WIND STORMS

Little diagonal streaks or wrinkles across the grain of a piece of timber not only betray weakness, but sometimes indicate periods of stress through which the wood passed when it was growing. They may even be taken as a sort of check on the official record of wind storms, as in the case of some lumber tested at the forest service laboratory at Madison, Wis.

The marks are caused by what are called "compression failures," which occur when the fibers bend or buckle under a too heavy strain. In cutting up logs collected for experiments at

the laboratory, it was noticed that these compression failures appeared on the north side of a number of trees which came from the same locality in Florida. By counting the annual rings of the wood and from knowledge of the time when it was cut in the forest, it was decided that the compression failures must have been caused by a severe wind from the south about the year 1898. Inquiries were made in Florida and it was found that a hurricane had, in fact, swept over the region at the time indicated.

The experiments have determined that the strength of a piece of wood may be seriously impaired by slight compression failures due to rough handling. Dropping a beam across a skid may cause a compression failure at the point at which the beam strikes the skid and it will be at this point that the beam gives way when it breaks under a strain too severe for the weakened fibers to withstand. Hitherto unaccountable breakage in hickory wagon spokes and other presumably strong material are now attributed to compression failures caused by wind storms in the period of growth or by hard usage in lumbering and manufacturing processes.

SELECTION OF AUTO SHOW AND TRUCK CONVENTION DATES

The National Automobile Chamber of Commerce has decided on December 31 as the opening day of the next automobile show at Grand Central Palace, New York. The Chicago exhibition will open January 22, 1916. This decision was made at the quarterly meeting held in New York, March 4, presided over by President Clifton and at which over 65 companies were represented.

Following the report of the Commercial Vehicle Committee, the manufacturers in the chamber selected May 5 and 6 as the dates and Detroit as the place for a convention of commercial vehicle interests, following the regular monthly meeting of the directors, which will also be held at Detroit. To this gathering will be invited all the leading commercial vehicle manufacturers, including those not members of the N. A. C. C.

Evidence that the recent shows at the Grand Central Palace, New York, and the Coliseum at Chicago, broke all records for attendance, and the amount of business done was shown by the report of S. A. Miles, the show manager. There will be a 97 per cent. return of the amount paid for space at the New York show and 83 per cent. on the Chicago exhibition space.

Reports by W. E. Metzger, chairman of the Traffic Committee, show that February shipments of automobiles were 11,064 carloads, a substantial increase over the figures of February, 1914, which were 10,572 carloads.

NATIONAL SHOW OFFICERS

At the annual meeting of the National Implement & Vehicle Show Company of Peoria, Ill., February 8, the following directors were elected: C. A. Pattison, J. B. Bartholomew, Warren Sutliff, J. W. McDowell, H. B. Morgan, Geo. T. Page, L. R. Turner, F. H. Bush, W. O. Ireland, A. J. Tapping, L. M. Hines, Leroy Page, W. G. Causey, D. H. Bethard, Gerald Franks, M. X. Chuse, Theodore Kuhl and Louis Anheuser. Improvement and expansion as to grounds, buildings and exhibits is to be the policy of the new board.

The newly elected board of directors elected the following officers: President, Warren Sutliff; first vice-president, C. A. Pattison; second vice-president, L. H. Turner.

A PIVOTED PERCH

Mr. Odling has designed and constructed for the Commonwealth Department of Defense a military transport wagon, which has a jointed perch and pivoted back axle, which enables the wagon to be turned in about 22 ft. The back half of the perch slides between futchels, and is slotted to take the hind perch bolt. The pole is pivoted to lift.—Australasian Coach Builder and Wheelwright.

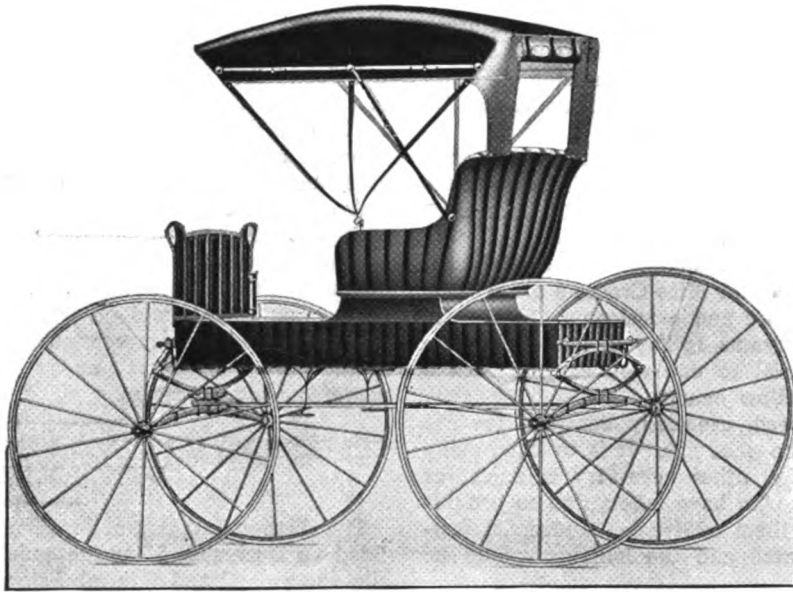

YOUNG MEN'S BUGGY, AUTO TOP.
 Built by Union City Carriage Co., Union City, Ind.



PIANO STANHOPE BUGGY.
 Built by Hopp Carriage Co., Mifflinsburg, Pa.

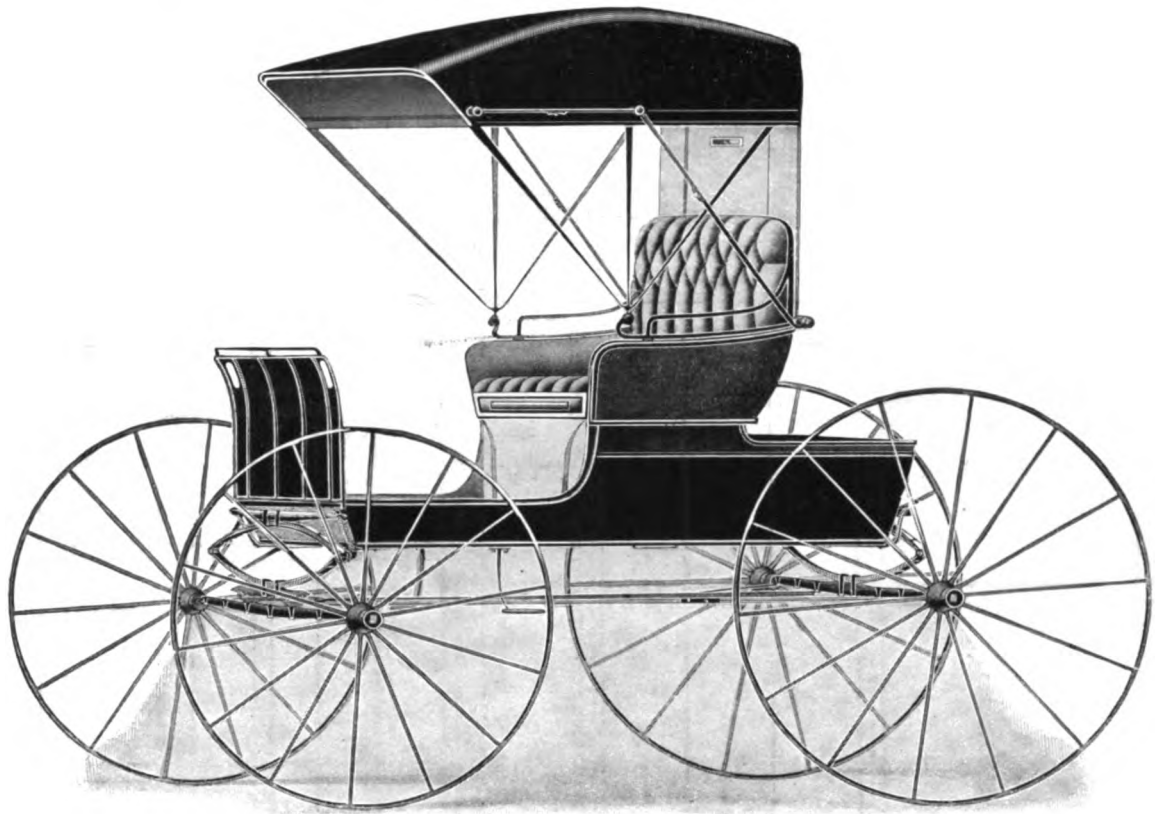

PHAETON-SEAT CORNING BUGGY.
Built by Luth Carriage Co., Cincinnati, Ohio.

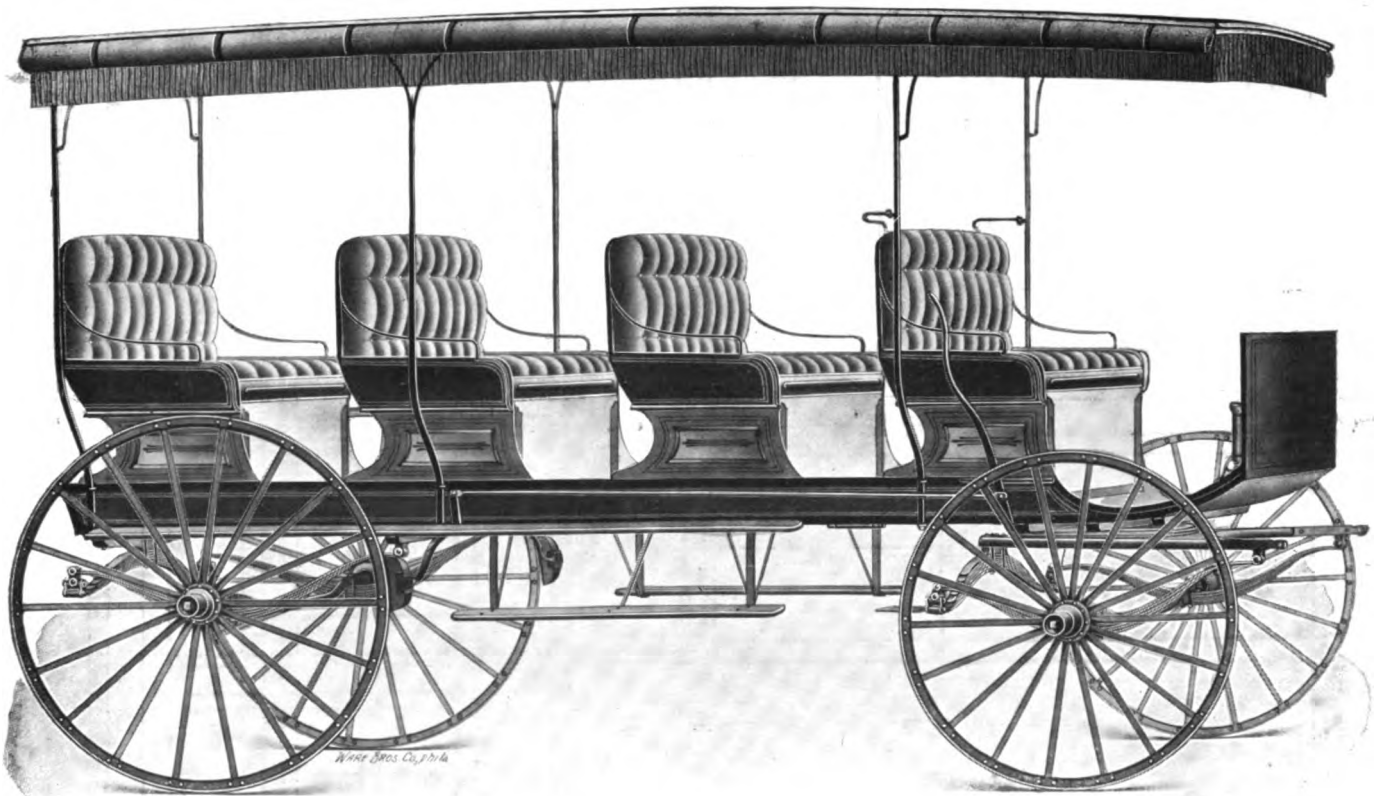

TOURIST WAGON
Built by Hopp Carriage Co., Mifflinsburg, Pa.

MOTOR AMBULANCE FOR MILITARY SERVICE

The following is a description of a military motor ambulance to carry four stretchers, taken from the Australian Coachbuilder and Wheelwright. When used as a quick transport, the top stretcher seats are folded up against side of body, and held in place with straps. Front seat is full width of body, giving ample accommodation for driver and attendants. Stretcher-holders are fastened to seats, with 3-inch butt hinges, allowing holders to lie flat. The water tank is fastened under front seat. A door the size of tank is made in side panel, to allow tank to be removed when required. A large size tap is fitted to rear end of tank. At rear of body, the doors are hinged at the bottom, being more convenient when stretchers are put in under the seats. A door 3 ft. 9 in. long by 9 in. wide is cut out of kauri panel, forming bottom seats, to allow access under seats.

Bottom sides, back and front cross bars are boxed out for a 3/4-inch floor. Centre bars are 1 1/4 in. thick, with floor boards screwed on top. The side frames have six short pillars,, 1 1/4

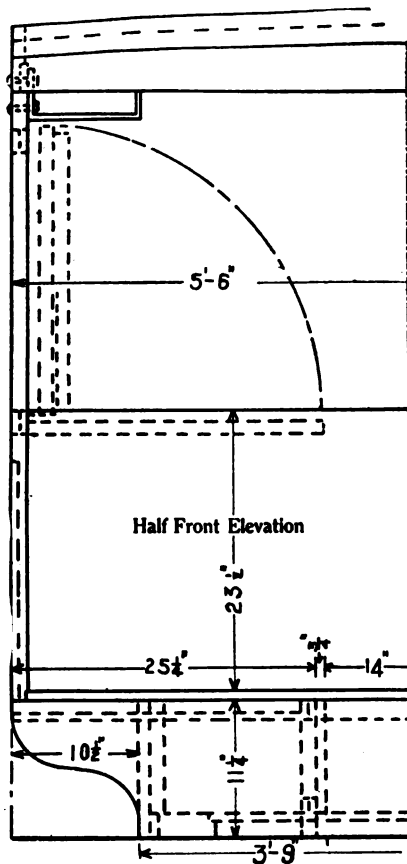

in. long by 1 1/2 in. wide by 1 1/4 in. thick, half lapped to bottom sides, with a rail 1 3/4 in. deep by 1 1/4 in. thick, half lapped to top of pillars. Side panels are 11 1/4 in. deep by 3/4 in. thick. Two frames 1 1/4 in. thick are half lapped to the bars, making passage way in center 14 in. wide. Heel boards are 3/4 in. thick, screwed to the center frames. Front heel board is full width of body (5 ft. 6 in.), the ends cut to shape shown on front elevation of drawing. Five bars each side, 25 1/4 in. long by 3 in. wide by 1 1/8 in. thick, are half lapped to top of rail of center frames, and project over side panels 10 1/2 in., with a rail 2 1/4 in. wide by 1 7/8 in. deep, lapped to outer end, for the long side pillars to lap into. A panel 9 in. wide by 1/2 in. thick is let into bottom of side pillars. The panel at end of front seat is 20 in. deep by 3/4 in. thick, let in flush with outside of the 9 in. by 1/2 in. panel. Panel forming front seat back, is 24 in. deep by 7/8 in. thick, screwed to back edge of pillar.

The top stretcher seats are hinged to center side rails, with 4 tee hinges, supported when down by swinging brackets which are fastened to back corner and center pillars. The front end is supported by a 3 in. by 1 in. fillet, fastened to front seat back.

Two stretcher brackets each side are bolted to top of side pillars, to carry stretchers when not in use.

Canopy side and end rails are 1 1/8 inches thick. The bows are 1 1/4 inches wide by 1 3/8 inches deep, with a 3 by 3/8 inch kauri batten, let into center, and 3 battens 1 1/2 by 3/8 inch let in between side rails, and center batten, to support covering material. A plate 1 3/4 inches wide by 3/8 inch thick, is bolted to back bar, and up back corner pillars. A large size red cross is painted on side and back curtains, and storm curtain in front, also on roof covering. Two sockets are bolted to near side front pillars to carry a flag.

HORSE VEHICLES IN THE "AUTOMOBILE CITY"

Does anybody think the horse vehicle has "gone" or that it is "going?" If there is any city in America where one might expect the horse to have become obsolete that city is Detroit, Mich., the automobile capital of the world. We hear a great deal about Detroit's automobile and motor truck manufacturers. They have been in the limelight for several years. Their products are known around the world. Their immense factories and quantity production are the wonders of the age.

Yet in Detroit we can see horse-drawn trucks used in the daily work of the motor car manufacturers. It is no uncommon sight to see horse-drawn wagons loaded with motor car parts, bodies, etc., on the streets of Detroit. Nothing, it seems, can take the place of horses on these comparatively short hauls.

The use of wagons is still general, even in the city most famous for its production of power vehicles. Wagon building was one of the earliest businesses established in Detroit, and at this time it still flourishes in at least thirty distinct shops in that city.

The big trucking concerns stick to horse-drawn wagons for most of their work between factories and wholesale houses, and the railway and steamer freight sheds. The comparison between them and motor trucks at these receiving points is in favor of the horse, for there are some kinds of work in which gas is not as good fuel as oats.

The wagon makers in Detroit always have held their own in face of strong competition from the State and outside. The quality of their goods has told the tale, for the vehicle made for work must be strong and honest to stand the strain imposed upon it. As one of the makers said: "Perhaps we do too good work, for the wagons never seem to wear out."

If one wants the strongest proof of the demand for work horses in Detroit let him go to one of the big public horse sales which are held every now and then in that city. Try to buy a nice pair for heavy hauling or for some other work that requires a good team. Note the rapidity with which the bids follow each other and the price at which the team is finally disposed of. Horses have never before brought such high prices in Detroit, and the main difficulty seems to be in getting enough horses to go around.

RADIATORS FOR POWER WAGONS

Of the various types of radiator which are found suitable for power wagon use, the smooth tube type is used extensively on recent cars of French build. The two water holders of the radiator are connected across by flat tubes placed side by side so as to present the edges to the air current of the fan, or in other cases the radiator uses a great number of round tubes of very small section (0.2 inch). The first method is used in the Berliet wagon, while the Renault employs the latter. Among smooth-tube make-ups, the Goudard and Menneson merits special mention, and it was the type preferred for the Paris autobus, besides being in use on De Dion, Schneider, Delaugere, and other cars. An air fan is mounted inside a drum formed by a top and bottom water holder joined by circular tubing. Such tubing has five rows in width and the same number in thickness, that is, the part occupied by the tubing has a square section, with 25 tubes. The air fan is designed so as to draw in air on each side

of the fan, and drive it out from the edge, and it thus passes through the set of tubes, which thus receive a strong draught. Hot water from the motor enters the top receptacle and after descending through the tubes it collects in the bottom holder and returns to the motor. One point about this type of radiator is that as the tubes are curved, they become stronger and chances of breakage are less. On the road, should a tube break, it is an easy matter to remove it and stop up the two holes left, and the radiator works as before. Gravity water cooling can be employed in this type without the air fan, as it will work well either way.

DISCOVERY OF NEW PROCESS FOR PRODUCING GASOLINE

Plan to End Standard Oil Co.'s Monopoly By Dedicating to Whole American People

Two important chemical processes affecting the motor car industry have been discovered by Dr. Walter E. Rittman, chemical engineer of the Bureau of Mines. One is a new method of producing gasoline and the other the manufacture of tuluol and benzol, the latter of which can also be used as a motor fuel.

Dr. Rittman plans to end the Standard Oil Co.'s monopoly by dedicating his patent to the whole American people so that the small refiner as well as the trust can avail himself of a cheap process for manufacturing crude oil into gasoline. Heretofore the Standard Oil Co. has had an advantage because it had the cost money, could employ the best chemists and therefore had the best processes for obtaining gasoline from the crude oil.

The first of these processes promises to enable independent refiners in this country to increase their output of gasoline from petroleum 200 per cent. or more. With an estimated production by the independent refiners of 12,000,000 barrels yearly, this will mean an output of 36,000,000 from the independents alone.

The second process enables benzol and tuluol to be made from crude petroleum, two products which heretofore could only be obtained from coal tar residues. Benzol is also a good fuel and is used extensively in Europe. However, it is planned to use these two substances for the production of explosives and dye-stuffs.

These processes are fraught with the utmost importance to the people of this country because for some time the Standard Oil Co., through the large amount of money at its command, has employed expert chemists and has thus had a big advantage over the independents in the production of gasoline. It has a patented process by which it obtains three times the quantity of gasoline from a given quantity of petroleum that the independents now obtain. There are two or three other large corporations that have an efficient process for the manufacture of gasoline, but the independents as a whole have never been able to even approach the results obtained by the Standard Oil Co. Now the federal government, through the efforts of Dr. Rittman, proposes to make free for the use of all the people of the country a process that yields gasoline from crude petroleum in three times the quantity heretofore obtained.

It is claimed by Dr. Rittman that his process is simpler, safer, and is more economical in time than the processes now in use and these economic factors are of great importance.

An interview with a Standard Oil official showed that this company has not taken the announcement of the new fuel seriously, although it is admitted that nothing is known of Dr. Rittman's discoveries. The company took the attitude that if the patents were given to the public it would be able to use them as well as anyone else; but it did not explain that in this case it would only be on an equal footing with the independent companies.

The Standard Oil Co. also pointed out that benzol and tuluol can be produced from very few crude oils; and that millions of

pounds of coal tar products are yearly burned under coke ovens, and that these products could be utilized in producing benzol and tuluol if it were not cheaper to buy them from Germany. No allowance, however, was made for the fact that Dr. Rittman's new method might reduce the cost of manufacture so low that it would be cheaper to make these products than to import them.

Full details of Dr. Rittman's new chemical process for increasing the supply of gasoline through his new formula will be made public by the Department of the Interior late in March. Dr. Rittman says that in his process all of the oil is vaporized.

The Rittman process, it is understood, will work on all oil residue. Dr. Rittman made it plain that he had a profound respect for the Burton process, this being recognized as the leading practice today in the production of gasoline.

MOTOR LAUNDRIES AT THE FRONT

The latest use to which the automobile has been put by the warring armies of Europe is that of a laundry for the field hospital corps. The laundry consists of four vehicles, the leading one being a very powerful motor truck on which is mounted a steam mangle, which is easily removable. The second vehicle in the train contains a complete steam plant with boiler, turbine, drying cabinet and disinfecting tank. The third truck carries the washing machine itself, centrifugal drying drums, pumps for hot and cold water and a condenser for steam when the ordinary water of the neighborhood is too hard to be used for washing. The fourth truck is loaded with soap, soda, coal, gasoline and tools. On the march all four trucks are coupled together, while at the points of the battleline, where the hospital has been erected, they are arranged in the shape of a horse-shoe. The entire "laundry" can be covered by a large tent. When in use, the train requires the attention of twelve privates and one non-commissioned officer. The motor truck, as soon as the steam mangle is removed, is used to carry laundry to and from the hospital. Bloody linen is first thrown into the disinfecting tank and boiled with strong soda and creosote soap. The drying cabinet is for woolen wear which is difficult to wring dry in the mangle. The capacity of such a laundry is about 3000 pounds of assorted dirty linen daily. It has proved a tremendous success at the field hospitals on the German side, and has greatly reduced the work of the sanitary corps, with far greater cleanliness and efficiency.

2,500,000 MOTOR CARS IN 1916

That on January 1, 1916, there will be two and one-half million automobiles in the United States, appears a somewhat wild prediction, when it is considered that there are only about 600,000 automobiles in the whole world, outside of this country. Figures collected from the various States of the Union show that on February 1, 1915, the number of registered cars exceeded 1,900,000, and the growth in the last 13 months has been equal to not less than 600,000 per year. As the rate of increase during the individual months has been much greater toward the end of 1914 than in the early part of that year, it seems certain that fully 600,000 cars will be added between February 1, and December 31, 1915.

BRITISH CYCLECAR WITH NOVEL POINTS

One of the latest "cyclecars" or "light cars" manufactured in Great Britain, possesses a number of unusual features, not found in any other automobile made. It has a 4-cylinder motor with both valves and spark plugs set horizontally into the cylinder heads; a full steel casting in the form of a pan, which forms the forward end of the chassis; a mechanical starter which forms the forward end of the chassis; a mechanical starter which works on the principle of a ratchet screw driver or drill, and a new type of cantilever spring which is said to possess unusual flexibility and resiliency.

The Jitney Bus

The latest development in motor travel, the use of pleasure cars for public conveyances, has apparently taken a firm grip on the transportation problem in many towns and cities throughout the country. In the western part of the country the jitney bus is everywhere receiving liberal patronage and the owners are making more than expenses.

Reports of the advent of the jitney bus are coming in from towns all over the country, and the reports of the operators of these increasingly popular passenger cars show surprisingly large numbers of passengers carried each day. From Kansas City, Mo., comes the information that the city is rapidly becoming "jitneyized." In three weeks over 222 were registered. Four, five, six and seven passenger cars are being used. One day's report showed 45,000 people carried. There are also buses which carry eighteen to thirty-five passengers. All cars carry the jitney sign on the windshield and on each side.

Each minute from six to ten jitneys roll up to the curb, at the headquarters of the Jitney Transportation Co., near the heart of the city, each loaded with five to seven passengers. The approach of each is heralded by the megaphone man who calls out the route and the destination. Each pauses for a few seconds, two or three get out, others take their place and the jitney is off on railroad schedule. Minute after minute, and hour after hour this caravan comes and goes, starting at 6:30 in the morning and stopping at 7:30 in the evening. After that hour all service is by special arrangement.

Just Touring Cars

And these jitneys are just touring cars. Cars with a sign on the windshield "Grand Ave. and 12th to Prospect and 27th," or of other streets. There is a big 5 on the windshield and perhaps others on the doors. Within a week the jitney association hopes to have a standard street sign that will be illumined at night and which can be readily attached to any car. In addition to the designation of the route it will contain a large 5 and a serial number as registered by the jitney association, in order to facilitate checking at different depots.

Anyone with a car can become a jitney operator. A dollar a week is needed. You pay that to the jitney association in order to get the privilege of being announced at the various dispatching depots and to get reduced rates on gasoline, oil, tires and other supplies. A little later a big garage will be conducted and every registered jitney will get repairs slightly above costs.

To register you present yourself and car at 1133 Grand Ave. and talk routes, etc., with E. K. Carnes, the general traffic manager of the company. You select a route you would like to travel. If too many jitneys are on it the suggestion is made that you take another route, but the final act rests with the car owner and operator.

Once registered each car is put on a schedule. Some routes have 2-minute service both ways, others 2.5 and others 5 or 10 minutes, according to the demands. This schedule is maintained and it rarely happens that one car passes another, in general the rotation of a trolley system being maintained.

"How can you make money by carrying a passenger for a nickle—a jitney?" is the question heard on every corner. The proof of the pudding is in the eating. A five-passenger car working on a route 2 or 2.5 miles from end to end is making \$7 to \$12 per day. These cars make the circuit in 20 to 30 minutes and are generally on streets with trolley lines. With the jitney you can save 10 to 15 minutes on the trolley trip. That is why they are so popular. The jitney company claims that it costs approximately \$2.50 per day to run a Ford five-passenger car. It costs very little more for Overlands, Buicks,

Studebakers, Hups, Maxwells, etc. One-half the jitneys here are Fords, but in addition to other makes mentioned there are several seven-passenger cars including Packard, Peerless, Oldsmobile, Stoddard-Dayton, Imperial, etc.

Five-passenger cars are possible in jitney service where the ride one way does not exceed 2.5 miles. This is the maximum. The minimum is slightly under two miles.

The Seven-Passenger Express

When you get over 2.5 miles and up to 4 miles the seven-passenger car giving an express service beyond the 2.5-mile limit is possible. Over 4 miles the jitney bus offers the only possible conveyance. Some of these buses carry twelve passengers and others twenty. They are single-deckers, entirely inclosed and with glass windows all around. There is generally one side entrance on the right, immediately back of the driver, who sits on a revolving seat, so that when he stops he swings partly around, opening the door and collecting the jitney as the passenger enters. When driving the seat obstructs the door, preventing passengers leaving. Some of these buses are averaging between \$20 and \$30 per day.

New buses are being registered every day, many of them preferring the 2.5 to 4-mile zone. These buses are generally built on old touring car chassis. A typical example is that of using an Oldsmobile chassis and adding a bus body seating fourteen and costing \$200. When a bus has to go beyond the 6-mile zone the single-decker does not pay, but double-deckers will have to be introduced. None has been started yet.

The jitney company reports that all day there is relatively uniform travel. In the early morning the workers going to the factory, the store, or the business office are passengers; a little later the professional man uses the jitney; and later in the forenoon the women shoppers are the majority of the passengers. At lunch time many people are going home who find this possible with the quick service, but which was impossible with the trolley schedule. During the afternoon shoppers go home and later the workers line the corners in thousands waiting for the jitneys.

Sale Lake City, Utah, has a line of jitney buses running and it is receiving liberal patronage from the public. The trolley companies already have felt the competition and there are indications of one of the usual contests following the introduction of new transportation methods.

From California comes the report that Los Angeles has a merry battle on and it looks as though the issue involved would go before the voters in the form of a referendum. The outcome of this contest will be interesting from two standpoints. The first is whether the public will choose between the bus over the trolley and the second is whether the voter will resist the wiles of the corporation fighting for its life any better than the voter's representative has done in the councilmanic body.

The proposition likely to confront the Los Angeles voter is in regard to the terms upon which the busmen may operate. The local council has made regulations calling for an indemnity bond of \$5,000 requiring that the route to be followed must be announced and that the buses must not deviate more than three blocks from this route.

The trolley men object to these rules on the ground that the bond is not high enough and because the bus folks are not limited to five cent fares. The busmen are against the bond and the route limit and so both sides demand the referendum.

Toledo Has Pay-as-you-enter Jitney Bus and Interurban Transportation

A Toledo, O., newspaper gives the following account of the jitney bus situation in that city:

"The interurban auto bus has appeared here.

"The new bus, a specially constructed Ford, capable of carrying 10 persons, will be operated between Toledo and Ida, Mich., 18 miles. The bus will be operated by Will and George Bell and F. Wright.

"The Wright and Bell machine will start from Samaria, Mich., at 5:50 a. m., and will bring a load of Overland employes to the city, reaching the Overland plant at 6:30 a. m.

"It will leave Summit and Cherry Sts. for Ida, Mich., at 6:45 a. m., and will pass through Temperance and Samaria. The machine will make four trips a day both ways.

"On four nights the bus will bring theater parties to Toledo, arriving here at 7:45 p. m., and leaving at 11:30 p. m. Single fare from Ida to Toledo is to be 65 cents; from Samaria to Toledo, 25 cents; from Temperance to Toledo, 20 cents, and from West Toledo to Toledo, 5 cents.

"The seats are upholstered in leather. The car is electric lighted and started. Only competition is the Ann Arbor steam railroad.

"New city jitney bus service also was announced by A. C. Bally, 932 Post St. The new bus is enclosed, of the pay-enter type, with a capacity for 24 people. Two similar cars are being constructed by Bally to be put in service on Toledo streets.

"The car will leave Delaware and Detroit Aves. It will go to Putnam St. to Twenty-first St. to Madison, to St. Clair to Jefferson, to Summit, to Adams, to Huron, to Madison and return to Detroit and Delaware Aves. by way of Twenty-first St. and Putnam.

"This car will start at 6:30 a. m. and will run until 6:30 p. m. An effort will be made to complete the round trip in 30 minutes.

"There are about 40 members of the Toledo Jitney Owners' Association. By-laws providing against trespass by members of the association upon routes established by other members have been adopted.

"Every member of the association will carry an official design on his car. The design will bear the initials of the organization in white on a blue background.

"Members are being taken into the organization daily."

The Jitney Bus in Canada

An interesting account of what the jitney bus is effecting in connection with the transportation situation in Vancouver, is furnished by Consul General Mansfield. He writes that jitney busses made their appearance in Vancouver about January 1, 1915. At first a few taxicab drivers and owners of automobiles appeared upon the streets with placards on their cars announcing 5-cent fares to various parts of the city along the routes traversed by the electric tram lines. The success attained by the pioneers in the project, and the popularity of the "jitney" in competition with the street cars encouraged others to engage in the business, and at the end of the first two months there were about 350 busses operating on city and suburban lines.

The average daily earnings are reported to be \$8 for each car, an aggregate of over \$80,000 per month. This competition has reduced the earnings of the electric railway and also affected the city revenues, as the municipality receives a percentage of the earnings of the street railway company, aggregating \$3,000 per month, in normal times. The report of the British Columbia Electric Railway Co., which has an exclusive franchise in Vancouver, for January of this year, shows that during the month there was a decrease of 1,138,333 in the number of passengers carried as compared with the corresponding period last year, when 3,364,062 passengers were carried.

In January, 1913, the street car company paid to the city \$2,766 as the city's percentage of the profits; this year the check amounts only to \$1,816, a decrease of 33 1/3 per cent. The city's loss at the end of 1915, if this rate is maintained throughout the year, will amount to about \$30,000. The rate of payment to the city is arranged so that an increase in the profits occasions an increase in the percentage due to the city; if the street car receipts continue to fall the city's portion of

the profits will also diminish.

Jitney Bus Business Put Upon an Organized Basis

The jitney bus business has been put upon an organized basis by the formation of the Vancouver Auto Public Service Association, the rules and regulations governing which are as follows:

The organization and regulation and control of routes and rates.

The supervision of the auto-bus men by experienced traffic managers.

Mutual protection and protection of the public using the "jitney" service by insurance to the extent of \$1,500 each passenger and \$5,000 per car; no driver to be personally covered where the accident is caused by his own neglect, but all passengers to be protected through insurance effected in a guaranty and accident insurance company of good standing.

The securing and retaining of favorable public opinion by efficient and safe public service.

The securing of a transfer system throughout the city by cooperation of the members to meet anticipated reduction of fares by traction competitors.

The members of the association are to be furnished banners designed to indicate security to the public and regulation and control of the jitney service.

The establishment of an autobus system in Vancouver has provided employment for a large number of men, and brought into use automobiles owned by people who were unable to maintain touring cars for pleasure. The rapid increase in the number of jitney busses since they first made their appearance in Vancouver and the increasing popularity of motor cars as a means of cheap transportation will soon give them a monopoly in passenger traffic on the streets of the city.

The question of responsibility, the regulation and control of the business, are questions that are occupying the attention of the municipal council. The innovation is meeting with strong opposition from the electric car company, but the sympathy and popular support of the majority of people who depend upon public service for transportation seem to be with the motor busses.

An application has been made to the city council of Vancouver for an exclusive franchise for operating motor busses, and the provincial legislature has been petitioned to authorize municipalities in the Province to grant franchises for jitney-car service under regulations along the following lines:

Power to examine and limit hours of service of drivers; prevention of overcrowding by limiting the number of passengers to be carried in each car; car owners to provide bonds for insurance of passengers and pedestrians against accident; the power to regulate routes to be traveled; power to limit number of cars running on any route; power to require each owner of an automobile carrying passengers for hire to provide insurance up to a maximum sum of \$5,000 for each car, a maximum sum of \$1,000 for passenger individual loss, and a maximum of \$1,000 for pedestrian individual loss.

The Spread of the Jitney Idea

The jitney bus idea has reached Bloomington, Peoria, Decatur and other central Illinois cities, but it is doubtful if it will be permanent, the business not being large enough to warrant the purchase of special cars. Automobiles holding five to seven passengers are temporarily in use. The street railway company managers are watching the performance of the new competition but say that it is not serious enough to warrant any action.

Although the jitney bus made its appearance in Milwaukee several weeks ago, it was not until Monday, February 22, that the latest public transit idea was firmly and definitely established here. The Milwaukee Jitney Bus Co., capitalized at \$100,000, has incorporated and started business with thirty 5- and 7-passenger cars, running on a strict schedule. Buses will be operated on five crosstown streets.

The jitney bus idea is rapidly spreading in the Buckeye State. Steps have been taken in at least four cities of Ohio to operate jitney busses on a more or less organized plan and outside of

Columbus the movement has apparently met with considerable success.

The first city to start the buses was Cincinnati, where the "Jitney Mobile Bus Line Company" was organized. Several lines were first established and passengers were numerous. Later on the promoters extended their operations to other lines, and at present about a dozen routes are being covered.

In Cleveland the idea became so strong that President John J. Stanley, of the Cleveland Railway Company, the traction system of that city, started a counter movement to operate 3-cent buses in competition with the jitneyists. Mr. Stanley claimed that his company was preparing to transfer from the buses to the traction cars, and vice versa. Three competing lines declared their work a great success, claiming that each bus should clear \$12 a day.

In Columbus the idea spread like wild fire when promotor William O'Hara announced the formation of a partnership. Before O'Hara could get his buses in operation a number of individuals started lines, mostly from the center of the downtown section to the east and the west corporation lines.

In Toledo the idea was very successful. There is a fight against the traction system in that city, because of the expiration of the franchise, and many of the people took to the jitney buses in order to register a kick against the traction system. In all more than 50 cars are being operated in that city.

In Dayton the jitney buses are also quite popular, and they are having an effect on the earnings of the local street car system. The announcement was made that the traction officials would operate buses in competition with the jitneys.

Williamsport, Pa., has a newly organized company operating jitney buses on various streets of the city.

A new corporation with a \$25,000 capital, will apply to Gov. Brumbaugh of Pennsylvania for a charter to operate a jitney bus line in Harrisburg and between that city and Steelton. About 50 vehicles will be put in operation, with a capacity for not less than 12 passengers.

The Buffalo Jitney Bus Co., Buffalo, N. Y., has been incorporated for \$10,000 to run a jitney bus line in that city. The incorporators are: Ella Ryan, R. E. Rayman, O. S. Kinsley, all of the White Building, Buffalo.

The estimated loss of the street railway company in Dallas, Tex., during the month of February, from the operation of jitney buses, is placed at about \$30,000. There are 412 licensed jitney cars in the city and the number is increasing daily. A public hearing on a proposed ordinance by the city of Dallas was recently held before the commissioners of the city. This ordinance will compel all jitney drivers to file a \$10,000 bond with the city assessor and collector of taxes.

As a result of this jitney service the sale of automobiles in the city of Dallas broke all former records, 136 licenses for numbers being issued. The former record was eighty-one cars in one week. The drivers of jitney cars have organized the Dallas Jitney Association and indications are that this service has come for good. The cars run cross town and to all parts of the city. Patrons of the street railways are taking to this new service.

Chicago's first jitney bus recently made its appearance and three more were soon started in operation. Limited as the service is in its beginning, it seemed to meet the approval of the public which patronized it to capacity. It is expected that this service with small cars will be extended by private interests. Meanwhile movements are under way by five different concerns toward the establishment of regular bus lines of from eighteen to thirty-passenger cars to operate on the streets and boulevards of the city.

Impetus has been given to this by the decision of the corporation council's office, that no franchises are needed. The situation is somewhat complicated at the moment by doubt as to whether the boulevards are open to the buses, as these are under the control of the park boards, which are independent of the city authorities.

The jitneys are operating in Paterson, N. J., in competition

with the street car lines of the Public Service Railway Co., one of the operating subsidiaries of the Public Service Corporation of New Jersey. In this way all quarreling is avoided.

The jitney bus has now invaded Winnipeg, Can., and over sixty touring cars are plying for hire on various routes in the city. The distance traveled by the majority of the jitneys, is within a 2-mile radius of the City Hall, and the fare is 5 cents. Several of the larger taxicab companies are having special bodies fitted to touring car chassis, with a passenger capacity of fourteen, and judging by the results obtained from the use of touring cars with a capacity of only five passengers, the new type should give excellent results.

A license fee of \$10 is charged to all operators of the jitney bus, but this is to be reconsidered by the City Council, owing to representations made on behalf of the Winnipeg Electric Railway Co., who are protesting against the service, owing to inroads on its income.

A DECIDED STIR IN THE TIRE MARKET

If January was particularly interesting because of the lifting of the crude rubber embargo, February made its especial claim for attention by the reduction of prices in the tire market and the introduction of a long needed reform in the methods of sale.

The Goodrich company announced on the first day of the month a reduction amounting to about 20 per cent. in the tires most in demand. For instance, the plain tread 34 x 4 was reduced in price from \$24.35 to \$19.40. In addition to reducing its prices it published a net list to the consumer. This company was followed immediately by practically all the large tire making companies in the United States, the reductions as a rule being about the same as inaugurated by the Goodrich company. The Ajax, Braender, Diamond, Empire and United States announced what was practically a 20 per cent. reduction, while the Firestone, Fisk, Federal, Goodyear, Kelly-Springfield, Lee, Pennsylvania and Republic made public in the press and through their salesmen reduction in some cases over 20 per cent. and in others a little under that figure.

The reason assigned for these reduced prices, following other reductions during the past two years, is the decidedly lower cost of material. Crude rubber is now selling at the lowest point since the rubber industry assumed any importance, and, as everybody knows, there has been a glut of cotton this year, sending the price of that commodity to a low point. To be sure some people have assigned another reason, namely, that the large manufacturers felt that there were too many small competitors crowding into the field and thought it advisable to make the industry somewhat less attractive for these new arrivals, but whether that be so or not, the low cost of crude rubber and of cotton is in itself quite sufficient to account for the new prices at which tires are now being sold.

The reason assigned for publishing the lists of net prices to the consumer lies in the abuse to which the old price lists have been subject, many of these lists being marked up to a high figure so that the retailer could lure his customer by making what appeared to be extraordinary discounts, these discounts amounting in some cases to 40 and even 50 per cent. And even so, the consumer has sometimes found that, despite the liberal—one might say munificent—discount he received, he could have bought the same tire elsewhere at a lower figure. This reform in selling methods was greatly needed. The car owner can now tell exactly what he must pay for any given tire and will not be worried with the suspicion that if he had gone across the street he could have purchased his tire at still lower price.

Some of the small retail dealers, says India Rubber World, are not pleased with the publicity methods of the manufacturers in giving out these new net lists and in stating their reasons for doing so. Some of the dealers think that these statements regarding padded lists are a severe reflection upon their methods, and in this they are quite right; but these methods were certainly open to grave criticism. To be sure, in a reform

like this the just and the unjust often suffer together, but, irrespective of the fact that some innocent dealers have had an imputation put upon their methods which they do not deserve, the business of retailing tires as a whole was greatly in need of reform.

The result of these new lists with lowered prices will undoubtedly be a considerable increase in the number of cars purchased, for once the maintenance of a car comes within the comfortable ability of people of moderate means the army of car owners will grow so fast that the present tire capacity of the American mills, great as it is, will be fully utilized.

BIMEL BUGGY CO. TO BUILD AUTOS

The Bimel Buggy Company, of Sidney, O., has announced that within a short time the manufacture of an automobile to be known as the "Elco 30" will be started in their plant. Arrangements are now being completed and contracts for material to build a light five-passenger car are to be made.

This car will be built of standard parts only, that have been thoroughly tested out. It will be of the latest type of four cylinder construction, complete with stream line body, one man top, wind shield, Davis motor, electric light, electric starter, artillery wheels, semi-elliptic spring and 30x3 and larger tire, and 102 wheel base. The sale price of this car complete, as above, will be \$500 F. O. B. Sidney. The company already has several contracts and orders for cars on hand.

George Bailey, who has had 14 years' experience in the automobile business, comes with the company as superintendent of automobile department, also Bert Klapp, an experienced draftsman and factory foreman, will give it his services, in addition to other skilled mechanics that will be employed.

The Bimel Buggy Company's plant is large enough to carry on its regular vehicle business which it will do with its present organization and share its spacious room with the automobile department.

The same officers and organization are back of both the vehicle and automobile business and can produce the car at the lowest minimum cost.

The cars will be retailed at the factory and sold to the wholesale trade throughout the United States. The cars are now in use and have been tested for more than four months.

The bodies will be built by the Sidney Manufacturing Company, at Sidney.

FREIGHT RATES ON EXPORT SHIPMENTS

This interesting communication has been received from E. W. McCullough, secretary and general manager of the National Implement and Vehicle Association, Chicago:

"It will, no doubt, be of interest to you and your readers to know something of the steps which have been taken by our association to protect the interests not only of the manufacturers, but the retailers and consumers as well, along transportation lines. Our executive board at a recent meeting authorized the employment of special counsel to prepare and present the case of the manufacturers and dealers relative to the effort being made by the railroads to cancel the "Stoppage in Transit" service, which has been in use for more than 20 years, and is a vital trade necessity, also is an adequately paid for service. The advancing of the rates on export shipments approximating 12 per cent. where domestic rates were only advanced 5 per cent. has added another burden to the already large number attending the export trade, and is likely to prove a serious handicap to the American exporter of implements, vehicles and farm machinery. Another matter is that of what is commonly known as "Car Spotting Charges" which is now before the Interstate Commerce Commission and involves the making of certain charges by the carriers for service heretofore furnished free. While undoubtedly it may be just for the carriers to make charge for certain special and discriminatory service, yet the bulk of spotting service is such as should be fur-

nished free, either to complete proper service from point of origin to destination, because the shippers and receivers have provided terminal facilities which the carrier ordinarily would be expected to provide. "In all the foregoing cases the association is not only represented by special attorneys, but the expert traffic managers of our members who constitute our Transportation Advisory Committee. These efforts are not made to deny the carriers just returns for their services, but simply to insist that an equitable basis be fixed for reckoning them. In the "Car Stoppage Case" the association is in close affiliation with the retail dealers' organization, who represent largely the 'men who pay the freight.' We confidently expect satisfactory results in all these cases undertaken."

COMPETITIVE TRADE SCHOOL SCHOLARSHIP

Through the generosity of E. M. Walsh, painter and decorator, New Haven, Conn., member of the advisory board of the boardman apprentice shops, a prize scholarship of the value of \$100 has been established. A competitive examination was held on January 16, 1915, open to candidates for admission to the course in painting and decorating in the boardman apprentice shops, New Haven.

The course, as outlined, is slightly more than two years in length, and includes 4,800 hours of instruction. According to the published announcement, additional prizes are open to students after enrollment in the course, as follows:

- No. 1. Paint and Oil Club scholarship, \$100, New Haven.
- No. 2. National Lead Co. scholarship, \$100, New York City.
- No. 3. Master Painters' scholarship, \$100, New Haven.
- No. 4. The R. P. Rowe scholarship, \$100, New York City.

It is the purpose of these prizes to assist boys in paying their expenses while at school, the \$100 representing approximately one-half of what a boy would be able to earn were he at work in the usual occupations open to him during this period. Upon completing the training, positions are guaranteed by the master painters of the city of New Haven, who agree to pay to the graduate upon the completion of his time from \$2 to \$3 per day, with steady employment, and to give him an opportunity to progress in the trade.

The plan is similar to one in use in certain European countries, and a modification of the plan used extensively by children's aid societies in the United States in the effort to keep children longer in school. Its possibilities will appeal to school officers in many cities.

DANGEROUS FIRE SEASON FORESEEN

The possibility of a dangerous spring and summer fire season in the national forests in the west is presaged by reports that two forest fires occurred in January and that the snowfall in much of the Rocky Mountain region and in the foothills has been much below normal. January fires are almost unheard of in the national forests and the snow reports are regarded as especially significant, as they indicate that unless the deficiency is made up the forests will be dry earlier in the spring than usual, with a consequent increase of the fire menace.

The fires occurred in the Pike forest, in Colorado, and the Black Hills forest, in South Dakota, the latter believed to have been of incendiary origin, according to the District Forester at Denver. About 75 acres was burned over all told. They were the only national forest fires reported for January.

The District Forester at Ogden, Utah, in charge of the national forests in Nevada, Utah, and southern Idaho, reported that the snow in this region also is far below normal.

ALL OHIO VEHICLES MUST CARRY LIGHTS

A law has been passed by the Ohio General Assembly compelling all vehicles, both motor-driven and horse-drawn, to carry lights, visible from in front and behind when operated on all of the public highways and streets of the state after sundown.

Paint Shop

STOPPING VERSUS PUTTY

The Australian Coachbuilder and Wheelwright gives the following hints on body stopping, with putty and formulas of same, especially for quick work.

Hard stopping for high-grade new work is made with dry white lead mixed in four parts gold size and one part hard varnish. Mix this to the consistency of soft putty. It should also be well beaten with the mallet or an old spoke. This operation thoroughly breaks up the lead and helps to **make** the stopping tougher. This stopping is for use on work that is to be filled up, and should be kept in a vessel containing sufficient water to cover it. This will keep it moist and fit for use when required. For dark grounds tint with vegetable black. For red grounds tint with any of the cheap reds, while for white or yellow grounds use the stopping without any tinting.

For general and repair work, such as bodies and seats, mix dry white lead in gold size only. Tint as desired. Use a slow-drying size if time will allow, but if time is short use a quick size. If a quick size is not on hand add a drop of terebene. This stopping should be in fit condition to face down in from four hours upwards according to weather conditions.

For wheels and gears, mix dry white lead in equal parts gold size and turps; which is sandpapered down when hard with No. 2 paper.

Another formula is to mix equal parts dry white lead and whiting, using the same medium as when mixing the lead only.

This is a system of filling up running parts which had its birth among our American brethren, and is mixed in the following manner: Take equal parts dry white lead and gilder's whiting. Mix with three-fifths raw oil and two-fifths gold size. Have this in a paste form, thinned sufficiently to allow it to run loosely through the mill.

This stopping is very useful in new work that is very open-grained, or repainting work that is in an advanced stage of decay.

It is applied as follows: Apply a coat of this mixture with a bristle brush, and before it has time to set, level the work down by rubbing with the bare hand; also cleaning out all corners where stopping may have accumulated. This operation leaves the surface in a fairly smooth condition, so that it will require very little sanding.

Now both of the above formulas will produce a good finish on the various classes of work which passes through the paint shop; but each of them is dirty and injurious to the health of the painter. In using sandpaper stopping the one who is sanding is inhaling the white lead in the shape of dust, and so are the other hands who may be working in the vicinity. All who understand the nature of white lead will freely admit the work is unpleasant and unhealthy. Yet we find many shops still use this method to build up defective surfaces. In sanding down you introduce the lead into the system when breathing. In the rub lead system the lead is absorbed through the pores of the skin. I maintain the painter should for his own sake pass both these formula on one side and substitute what the writer has advocated and used for many years, namely Japan putty.

Japan putty is made with best gilder's whiting, black Japan and raw oil. Be sure your whiting is free from dirt, is of a good color, and, above all, free from any sign of dampness. Your black Japan should be a slow-drying one. A quick-drying Japan lacks life and elasticity and is liable to go to pieces quickly. This is building up a foundation for the subsequent finish, and in asking our readers to give it a trial, it is only reasonable to request them to use material that will help to attain the desired goal.

In mixing this putty, first break up all lumps in the whiting, then mix with two parts raw oil and one part black japan; beat this mass thoroughly with a piece of wood to insure thorough mixing, having your putty fairly thin.

Taking this in the hand same as ordinary putty, fill up all open grain timber and joints, etc.; in fact, every place requiring filling. As you carry the work on there are many places such as open grain where a rub with the hand will help to level up the work. The time usually devoted to sanding down sandpaper stopping may be devoted to careful cleaning up of your puttying. A rub over with curled hair when hard is all that is necessary with Japan putty, although it may be also sanded down the following day if so desired.

With the exception of white or yellow grounds the painter can use this formula with every confidence for mixing his putty. It is of a tough elastic nature, whereas the other formulas produce a substance that is brittle and liable to fly off at any time. Japan putty stays where it is put rigid and tough, and the process is not by any means injurious to the health of the painter.

SIAM'S PURCHASES OF PAINTS AND VARNISH

The value of the imports of paints into Siam for the last five fiscal years has averaged \$148,346 per annum. The imports for the fiscal year ended March 31, 1914, amounted to 1,730,395 pounds, value \$127,306, of which the United Kingdom supplied 1,275,832 pounds, value \$89,160; British dependencies, 351,240 pounds, value \$28,826; Germany, 56,250 pounds, value \$5,774; and the United States, 7,408 pounds, value \$572.

During the fiscal year ended March 31, 1914, 135,467 pounds of varnish, value \$14,914, were entered by its customs at the port of Bangkok, against \$16,045 worth for the preceding year. In 1914 the United Kingdom and dependencies supplied 109,512 pounds, valued at \$13,055, and the United States 6,618 pounds, value \$702.

Little diagonal streaks or wrinkles across the grain of a piece valorem.

OPPOSED PROHIBITION OF WHITE LEAD

The Interstate Commission sitting at Sydney, Australia, to inquire into the question of revising the Commonwealth Tariff, examined several witnesses in reference to danger of lead poisoning in the painting trade. The Commission went so far as to suggest prohibiting the importation of white lead. This was opposed by the local Association representing employers in the painting trade, on the following grounds:

(1) White lead is an indispensable material in the painting trade, and it would be as inadvisable to prohibit its use as it would be to prohibit the use of lead in any form.

(2) Though we do not deny the existence of the disease, lead poisoning, our experience goes to show that it occurs rarely among painters in Australia. This is due mainly to the conditions under which work is now carried on.

(3) A reputation of unhealthiness was earned by the painting trade prior to half a century ago, when white lead was handled by the painter as a dry powder, in which form it was made up by him for use as paint, or as a base for sandpaper stopping. These conditions do not now obtain, except in certain European countries, some of which have passed restrictive legislation in connection with the use of white lead.

(4) Formerly sandpaper stopping especially was a fruitful source of poisoning when it was the recognized process for surfacing work. The fine dust from the lead stopping was inhaled. In coach painting in Australia lead stopping is still used by

some incompetent, or careless workmen, but by the majority it has been abandoned in favor of other methods. In house-painting the process is forgotten.

(5) White lead in oil may be handled in safety. Paint made from it is applied in a thick state, and sparingly. A workman need not get it upon his hands or clothes. The old idea that lead vaporizes and may be inhaled in the fumes of turpentine is exploded.

(6) Few painters are employed all their time applying white lead paints. Their employment is spread over such work as, washing down interior walls, stopping and preparing surfaces preparatory to painting, applying water paints, kalsomines and limewash, hanging wallpapers, applying dark colors which have no lead in their composition, graining, staining, varnishing, and a number of other duties which do not bring them into contact with lead in any form.

(7) Substitutes now offered for white lead have been in competition with it for centuries but do not fulfil its functions. Zinc white is deficient in body, dries badly, crazes, and renders repainting difficult and expensive. Lithopone is unreliable. It usually turns black on exposure a few days after application, and is not lasting. Barytes is not a pigment but an adulterant.

SLEEPING NEAR WET PAINT—AN OLD IDEA EXPLODED

Sir Thomas Oliver, Professor of Medicine in the University of Durham College of Medicine, Newcastle, lecturing at the Royal Institute of Public Health on injurious occupations, exploded an old and prevalent idea with regard to lead poisoning.

The opinion had hitherto been held, he said, that people who slept in newly-painted rooms were liable to suffer from lead poisoning. This view was held by Professor Baly, of Liverpool, who examined by means of a spectroscope the vapors given off from lead painted surfaces, and found a spectrum of lead. He repeated the experiments, because other chemists did not agree with him, and found that it was not lead, after all, but certain organic bodies called aldehydes, and he attributed the symptoms to aldehydes. On the other hand, an American, named Gardner, of the Research Association of Washington, has made a large number of experiments, and found that the emanations did not contain lead at all but carbon monoxide.

"I myself," added Sir Thomas, "have exposed many guinea pigs to the vapors given off from these lead-painted surfaces. The animals have died from symptoms within two or three hours which were not those of lead poisoning at all, and on examining the blood of these animals, taken after death, I have found carbon monoxide."

ZINC WHITE PAINTS

With a view to learning something of the success of zinc white, I have gathered much information from the larger consumers. To sum up the evidence, it would appear that while zinc white is suitable for second coatings, fillings, stoppings, and ground coats generally, it is a failure when used as a primer. This opinion has been verified by one of the large railway companies, using many tons of zinc white during the course of the year, and keeping an absolute record of every job. The greatest fault found was its liability to peel away from the surface, showing a want of key on both wood and metal. . . . I do not for a moment contend that this must necessarily prove that zinc white is to be useless for these purposes, but there does appear to be room for investigation into the methods of mixing zinc white to suit these conditions. In each case mentioned the zinc white was purchased in the paste form, ground in oil and thinned with genuine linseed oil and American turpentine. Part of the fault may be the method of mixing, and it is up to the manufacturers to indicate the correct method, or supply a thinning ready for use that will turn these failures into a success.—The Decorator.

FIXING SHAM CANE

This process, which is not properly understood in all paint-shops, is carried out as follows: Cut out paper patterns the exact size of the panels to be filled, then cut the sham cane, and see that this fits properly; then lightly flat the panels, and prepare for varnishing. Carefully wash the pieces of sham cane in warm water, dry with chamois, and lay out on boards in the varnish rooms, where they will get warm, not hot. Reduce some isinglass to a thin consistency, and brush carefully over the panels, then place the sham cane in its place; brush over with isinglass and leave to dry; two pairs of hands will be necessary to hold the cane in place. Immediately all the pieces are in place, pin on the gutta-percha beading, and wash off with clean warm water, and get the cane work thoroughly dry, and, after painting and finishing the bead, finish and varnish. Some use gold size thinned down, but this requires expertness; by the isinglass the whole can be removed with little injury if anything goes wrong. The sham cane will not adhere well to a double-swept panel if there is much roundness on it. Up to $\frac{3}{8}$ in. round in the foot of length on a phaeton quarter panel for instance, it can, by warming it over a stove, be got to lay close. There should be no difficulty on flat or single-swept surfaces.—Automobile and Carriage Builders Journal.

COLOR

A prominent French artist speaking of the laws of harmony and contrast of color says:

"All colors, without exception, can be brought together in a harmonious manner. The harmony between any two tones arises from graduation, proportion, the introduction of other colors either in their mass or around them, a thousand indefinable causes which the instinct of the eye alone can combine. The Orientals are the most amazing masters of such combinations. They have had the good luck to have remained in happy ignorance of complementary colors. See how difficult it is for a European painter or decorator to harmonize our national colors, red, white and blue. From Japan to Morocco, passing through Persia, you will find these three colors on every kind of china, and the effect is always charming. Painters and decorators! Do not ask more from science than it can give you. Ask for solid and enduring tints and pigments, good varnishes, etc., but do not ask more. It will never make you see, if you do not see already, and if you do see, it will confuse your vision by its necessarily inexact theories."

PAINTING RADIATORS

The following is taken from information published by the educational bureau of the Paint Manufacturers' Association of the United States. It is stated that the facts relate to stationary radiators for heating buildings, but, no doubt, they would also apply to other heated surfaces to a great extent: In a series of investigations carried out by John P. Allen, it was demonstrated that the nature and color of the paint applied to radiating surfaces exert a material influence on their heating efficiency. It was also shown that this influence is confined to the final coat applied, irrespective of the number or nature of the underlying coats. The painting of radiators may materially affect the transmission of heat. A series of experiments were conducted about two years ago to determine the effect of painting. Two cast-iron rectangles were used; one was painted and the other left unpainted, so that the painted radiator was always compared with the same unpainted radiator. The radiators were first tested both unpainted, and the condensation in the two was practically alike. One radiator was then painted with two coats of copper bronze, and it was found that the heat transmission was reduced 24 per cent. from the original cast iron. Two coats of copper bronze were then placed upon a radiator, and the heat transmission was reduced 25 per cent. Two coats of terra cotta enamel were then placed over the four

previous coats, and the heat transmission was 3 per cent. better than the original cast iron unpainted. This was repeated with fourteen coats, the last two coats being aluminum bronze. The transmission then showed a reduction of 27 per cent., and additional tests were conducted with various enamels, japan, lead paint, and zinc paint. In general it has been shown that aluminum, copper, and metal pigments in the bronzes reduce the heat transmission. This is probably largely due to the composition of the bronze and partly to the vehicle which contains this pigment. Enamel, lead paints, and zinc paints almost all show no loss in heat transmission. The experiments show that the effect is largely surface effect, and not conduction effect. The results show that the loss of heat from radiators depends largely upon the surface effect, and to a very small extent upon the conduction of heat through the metals. In these tests the best results were obtained by the use of a snow-white enamel and a zinc oxide paint, the two showing exactly equal efficiency.

DYESTUFF SITUATION IN UNITED STATES

Secretary of Commerce Report to the Senate—Germany Was Chief Producer of Imports from Europe

Numerous American industries are closely dependent upon the use of dyestuffs. To the great textile branches they are almost as essential as their supplies of vegetable or animal fibers. The same condition exists in the paint, varnish and ink trades, the paper industry, the feather and leather trades, and a group of minor industries. Dependent upon the products of these industries are a host of other branches, all users of textiles. The old-time natural dyestuffs, such as indigo, madder, cochineal, orchil, fustic and a score more, have no longer an extended use, with the exception of logwood, which still plays a valued auxiliary role. The same is the case with mineral colors, with some inconsiderable exceptions, such as Prussian blue in silks and iron buff in khaki.

Artificial dyestuffs, derived from coal-tar products, have displaced nearly all rivals, combining qualities of fastness, ease of application, brilliancy, variety of shades, etc., utterly unknown to the former generation of dyers.

Effect of War on Dyestuff Consumers

The American consumption of artificial dyestuffs has attained an annual value of \$15,000,000, and grows steadily.

It is supplied partly by a domestic production valued at about \$3,000,000. This apparent domestic production is based chiefly upon the use of foreign materials—half-made or nearly completed color compounds. But a small portion is made from American crude coal-tar compounds.

The great bulk of the artificial dyestuff comes from Europe. The average imports are: From Germany, \$7,850,000; Switzerland, \$910,000; Great Britain and others, \$370,000; total \$9,130,000.

Since August 1, 1914, in consequence of the outbreak of hostilities in Europe, this foreign supply has been interrupted and constantly threatened with nearly complete cessation. Until the present date German makers have been able to supply a considerable proportion of the normal demands of their customers, but not entirely. Some important dyes are totally unobtainable. Prices have mounted from 25 to 50 per cent. on such dyestuffs as can be delivered. The imports may cease any day through inability to make shipments, on account of maritime dangers, or what is more probable, through the military necessity of commandeering the available supply of the chief coal-tar crude material, benzol, for use as a motor fuel, or diverting the limited supply of nitric acid—the chief chemical used in color manufacture—to the manufacture of explosives.

The multitude of users of dyestuffs in the United States have been crippled in various ways, forced to change designs, or abandon certain products, or to revert to a temporary use of natural dyestuffs, with all the accessory readjustment and revolution in dyeing processes. On every hand there is difficulty in meeting contract specifications and in making definite plans

and agreements for the future. The importation of dyewood has quickly increased. It is now four times as great as in normal times. Prices of these dyewoods have mounted. Fustic, for example, has doubled in price.

The four American establishments making artificial dyestuffs have done their best to meet the emergency by enlarging the ordinary output. They have been crippled by the difficulties or impossibility of securing half manufactured materials from abroad or crude materials at home. Some large consumers of dyestuffs have erected emergency plants and make the colors they absolutely need, but at considerable cost.

Dominance of German Industry

In all this annoyance, loss and uncertainty, why do we not have an American coal-tar chemical industry capable of meeting the nation's demands, self-contained and independent of foreign control, utilizing our native raw material?

A careful analysis of the situation shows that not only is the American supply and the limited American production of coal-tar dyestuffs completely dominated by the German industry, but that this is the case throughout the world. Even countries such as Great Britain and France, with ample supply of crude material and highly developed industrial power, are in the same condition as the United States.

In 1913 the total consumption of artificial dyestuffs in the world had obtained a value of over \$92,000,000. Germany furnished 74 per cent. of the entire amount and over one-half of the materials needed to make the remainder. The only country, in addition to Germany, manufacturing dyestuffs in any noteworthy manner for the world's markets is Switzerland. That country relies, however, for its crude and half manufactured materials chiefly upon German sources. The dominance of Germany in the dyestuff production and commerce of the entire world is so marked, and inherently of such potential might, that it does not hesitate to make itself felt whenever and wherever an effort is made toward emancipation from its control. The methods used are those often associated with the working of great industrial corporations in various lands and now effectively checked by legal enactment in the United States. In the case of the German coal-tar chemical industry, the field is international and its operations are unchecked by law. Its influence has been felt at once in our own country when efforts to manufacture intermediate compounds or finished dyes threatened in any way the interests of the German production and trade.

Advantages Possessed by Germany

The coal-tar chemical industry includes not only the manufacture of dyestuffs, but a number of valuable medicinal preparations and of various high explosives. It is based upon the use of crude compounds present to a small extent in the tar obtained in the destructive distillation of coal in gas works and coke ovens. These ten crude compounds—benzol, carbolic acid, anthracene, etc.—are separated from some 145 other substances present in tar, by fractional distillation. This is the work of the tar distiller. From the ten crudes nearly 300 more complex compounds, none of them dyes, are produced by highly refined and complicated chemical and mechanical processes, involving in most cases a number of complete chemical transformations. These serve as the material for the manufacture of about 920 dyestuffs now in current use.

In the case of Germany the domestic supply of "crudes" is amply sufficient. The color factories make all of the 300 intermediates required for Germany's own industry and a large share of those used in the very restricted production of other lands.

The industry has been chiefly developed by the inventive power of German chemists, combined with a wealth of technical skill and keen business management scarcely equaled in the history of any other branch of manufacture. The twenty-one German companies engaged in the dyestuff manufacture have a nominal capital of over \$36,700,000, on which dividends average 22 per cent. Actual profits often reach 50 per cent. The great excesses have been devoted to new construction. It

solidly and formidably entrenched, the one of which the nation is most proud as showing the triumph of science applied to industrial purposes, and the one illustrating most strikingly the is the most remunerative industry in the empire, the one most able to win and maintain international supremacy in a given field.

Abundance of American Raw Material

In the United States the supply of coal tar is ample, sufficient to provide in abundance all of the crudes required for the manufacture of the dyestuffs consumed in the country. The amount of valuable by-products not yet recovered in our present coking plants amounts to \$75,000,000 annually. With adequate provision to save all the benzol and tar liberated in American coke ovens, enough of the ten crudes could be secured to more than cover the world's consumption in making artificial dyestuffs.

If a commercial demand is present, American tar works can quickly provide all of the crudes needed, practically as cheaply as in Europe. In the manufacture of intermediates the production is restricted to four or five compounds, and these cover about one-quarter of the needs of American color works.

Our manufacture of heavy chemicals is well developed, able to rapidly expand and supply all needed chemicals for the production of intermediates and their transformation into finished dyes.

The four establishments devoted to the production of dyes supply nearly 100 different colors, largely, however, as already stated, by "assembling" nearly finished products of foreign origin. These American firms are bold and enterprising, commanding about \$3,000,000 capital, evidently doing the best they can under existing conditions to build up a national industry.

Investigation shows that their advance, beyond certain limits, in the manufacture of their intermediate or finished dyes, is persistently checked and prevented by the united action of German producers in underselling. The entire German color industry is so completely organized and accustomed to act as a unit in furthering the general interests, at home and abroad, that little success in facing their determined opposition has heretofore been obtained.

The present crisis has evoked deep interest on the part of all concerned—tar distillers, manufacturers of chemicals, manufacturers of dyestuffs, the many users of the same, and American economists in general—as to how the problem can be settled. There is no question but that our coke interests are ready to multiply their recovery plants for the production of benzol and tar, if a permanent market is assured. There is no question of the readiness of tar distillers to enlarge their plants for the production of an ample supply of the needed crudes if a continued demand is certain. American chemical works and American manufacturers of dyestuffs are ready to embark capital and experience in building up a distinctly American coal-tar chemical industry, using entirely American crudes and intermediates, provided there is adequate legislative prohibition against both "dumping" or unfair restraint of American trade by the arbitrary action of foreign monopoly permitted by foreign law and not as yet forbidden by our own. Foreign makers assert their ability to make at once over 90 per cent. of the dyes now consumed in the United States, which are now patent free, and state that the remaining tenth will soon be freed from patent restriction.

What American Industry Requires

There seems to be a consensus of opinion that any rapid development and evolution of the dyestuff branch, on a scale commensurate with the nation's needs, present and prospective, can be assured only on the basis of an effective law preventing that action toward control of our markets by a foreign monopoly which is now prohibited to a domestic monopoly. Some of the largest manufacturers have personally informed the department that what is needed is not a tariff change but laws placing a foreign monopoly on the same basis as an American one.

American economists feel that the present crisis offers the

most favorable moment to decide upon a policy with regard to this one important industry, whether it is to be firmly rooted in American soil or whether the dependence upon a foreign source is to continue indefinitely. It is pointed out that each year elapsing increases in geometrical ratio the difficulties attendant upon any attempt to create a self-contained American dyestuff industry. Further, it is claimed that it is the only highly organized industry not yet brought on a broad and general scale within the cycle of American economic activity.

In England and France the textile and other branches have insisted that the national industries must be permanently freed from dependence upon a foreign source for one of the vital needs of the most varied manufacturers. Within a fortnight the group of French chemists intrusted with the problem claim that they have satisfactorily solved all difficulties in the way. During the same period the necessary steps have been taken in England, where the government has provided for the organization of a national company to create an independent dyestuff industry, contributing nearly \$2,000,000 to its capital, and granting at the same time \$500,000 for the requisite research laboratory.

FEBRUARY MEETING OF THE CINCINNATI CARRIAGE MAKERS' CLUB

The February meeting and dinner of the Cincinnati Carriage Makers' Club, was held at the Business Men's Club, Thursday evening, February 11, a very creditable representation of the members being present.

The nominating committee reported the names of the following candidates for the Board of Governors, from which five members will be elected at the annual meeting to be held on the second Thursday in March: Albert Armstrong, Emil F. Hess, Charles A. Fisher, William Haberer, George W. Huston, M. J. McNamara, C. W. Steele, Theodore Scheu, C. J. Rennenkamp and Henry Meyer.

Postmaster John L. Shuff was the speaker of the evening. Mr. Shuff, who was in the carriage business in Atlanta about 25 years ago, devoted the greater part of his address to that industry. He urged the club to co-operate in sending a representative to Mexico and to South America to get trade that he said would surely come to the United States. "Trade follows the 'coon skin' cash, and America needs to send money down there. That is what other countries have done." He spoke of extravagant collections and deliveries in the resident districts of Cincinnati from the post office and urged the business men to co-operate with him in facilitating the movement of outgoing mail. He spoke of the importance of the parcel post and postal savings departments.

The following resolution was adopted on the death of the late Mr. Alfred Hess:

WHEREAS: An all wise Providence has removed from our midst our exemplary and time honored member, Mr. Alfred Hess, president and founder of the Hess Spring and Axle Co., of Cincinnati, one of the principal accessory lines of the carriage manufacturing industry, a man we all loved and respected as an ideal citizen and club member, whose character was always above reproach and

WHEREAS: Was due to him as much as to any other member of any accessory line, the great development of Cincinnati as a large manufacturing center of the carriage and buggy industry, and

WHEREAS: In addition to his signal success as a leader in the accessory carriage industry of this city and as a familiar figure at all our national gatherings, as an honorable and philanthropic citizen of Wyoming, a suburb of Cincinnati where he lived, beloved by all neighbors, men, women and children alike be it therefore

RESOLVED: That we, the members of the Cincinnati Carriage Makers' Club, do publicly give expression to the love and high esteem in which he was held in our club and do hereby tender our condolence and sympathy to his family and business associates, and be it further

RESOLVED: That a copy of this resolution be sent to his family, spread upon the minutes of this organization and sent to the leading trade papers for publication.

O. E. WALKER, Chairman.
JASON SCHNEIDER,
HOWARD S. COX.

Trade Conditions in Canada

A Rapidly Developing Market of Which the United States Has the Lion's Share

Were it not for its customs tariff, the Dominion of Canada, so far as cultivation of trade therewith is concerned, would scarcely be looked upon by Americans as a foreign country, says V. Gonzales, foreign trade adviser of the National Association of Manufacturers. With its borders touching those of the United States for more than three thousand miles and with no visible dividing lines for the greater part of this distance; with similar climate and natural resources for long stretches on both sides of these borders; with the inhabitants on both sides largely from the same stock and settling their respective countries under like conditions, using the same language, sharing the same religious beliefs and holding similar attitudes with respect to national and civic development, and, despite difference in form, maintaining the same views with regard to popular government; with the constant flow of travel both ways across the border lines; with the continual interchange of workmen, settlers, business managers and educators; with interlocking railway systems, and with practically the same standards of currency, weights and measures, it is but natural that American manufacturers should look upon the development of trade with Canada as differing but little from the cultivation of markets in states of the Republic.

But as the Dominion is a distinct and separate country from the Republic, the Government of the Dominion naturally aims not only to develop its own resources to their fullest extent, but, also, through the influence of a protective customs tariff, to concentrate as much as possible the manufacture within its own borders of the goods which its people require.

This devotion to a system of tariff protection on the part of Canada has resulted in the establishment of numerous industries by Canadians and has also induced a large number of American manufacturers to erect branches of their own factories in Canada in order to secure to a larger degree a share of the markets of the Dominion which have grown so rapidly within the past decade.

Trade Does Not Always Follow the Flag and the Loan

Canada is an excellent illustration of the fallacy of some time-worn adages, or, at least, that generalizations are subject to many limitations, such as "trade follows the flag" and that investments or loans are essential to control of trade. Canada holds allegiance to the British flag, and Britain has loaned to the Dominion far larger sums than any other nation. Nevertheless, while the exports from the United Kingdom to Canada are large, they are far less than those of the United States. Moreover, British trade with Canada has had special encouragement through the preferential tariff which Canada has granted to the United Kingdom, of its own accord, for nearly twenty years. But despite this handicap, American goods in many lines almost monopolize Canadian markets so far as imports are concerned, and the total imports from the United States into Canada in the last fiscal year were more than three times greater than the total imports from the United Kingdom.

These facts show that constant intercourse, convenience of transportation, cheap freight rates, quick delivery, frequent solicitation of business by direct representatives, and supplying of goods that exactly meet the wants of customers, the advantages which American manufacturers in many lines enjoy over their British rivals in competing for Canadian trade, are factors which outweigh the influence of the loan and the flag by themselves.

With respect to the tariff advantage which, in many cases, seems so greatly in favor of British goods, it will be found, upon a study thereof, that while the preferential tariff was granted by Canada in the hope that eventually the United Kingdom would be induced to give Canadian products in the United Kingdom the advantage over competing foreign products by placing a duty on the latter, the Canadian tariff has been so adjusted as not only to afford a reasonable protection to the Canadian manufacturer against British as well as American competition, but further scrutiny thereof will also show that Canada has been liberal in her free lists, including therein particularly many items in the metal, heavy hardware, machinery and lumber lines in the manufacture of which American establishments are especially strong and are not handicapped by a tariff preference in favor of competing British products.

Source of Imports

Under the conditions described the United States has secured a commanding position in the Canadian import trade, its share thereof in the fiscal year ended March 31, 1914, amounting to nearly two-thirds (64.5 per cent.) The following table shows the total of Canada's imports for the year ended March 31, 1914, and the countries from which they came:

United States	\$410,000 000
British Empire:	
United Kingdom	132,000,000
Other parts of empire.....	24,000,000
Germany	14,750,000
France	14,500,000
Belgium	4,500,000
Switzerland	4,350,000
Cuba	4,000,000
Netherlands	3,200,000
Dominican Republic	3,200,000
Japan	2,600,000
Argentina	2,600,000
Italy	2,000,000
Austria	1,800,000
Mexico	1,500,000
Spain	1,350,000
Brazil	1,200,000
China	1,000,000
All other countries	6,450,000
	\$635,000,000

As Canada does not permit trading with the enemy nor the importation of enemy goods, there is a possibility that the United States might increase its trade with Canada through the calls made upon us to supply her with articles to take the place of those heretofore secured from Germany and Austria. Belgium is also crippled as an exporting nation, and much of the French industrial territory has been a battleground for months. There is, therefore, the possibility of a call being made upon us for the supply of an additional quantity of goods to the extent of \$36,000,000, provided Canada can maintain her former purchasing power, which it is by no means certain she can do.

Of course, we can continue to compete with British goods in Canada, as elsewhere. The United Kingdom, although in a state of war, is in practical control of the seas and it does not seem that its competing activities are, as an industrial power, seriously impaired, because of the abnormal conditions prevailing.

But the main thing for us is not that. It is the maintenance

of our present figures, or, at least, of our proportion, of 64½ per cent. of the total imports.

Exports

In the same fiscal year (1913-1914) Canada exported her own products to the value of 455 million dollars, or 180 million dollars less than it imported. These 180 million dollars represent a part of the investment of foreign capital which has been flowing in a stream as large as the one running into the United States, or much larger if proportion to population is considered. Strange to say, a part of that foreign capital has gone from this country. A borrowing country, as we have been, is not expected to be, at the same time, a lending one, but we have not taken so much the position of investors at large as of industrial settlers. Some of the Canadian industries represent American capital, because they are either owned by American corporations or are branches of American firms. Canadian municipal and land bonds have found a ready market here, and a good part of the northwestern and western lands have been developed by Americans and their money.

Exports from Canada are classified as follows:

Mining products	\$59,000,000
Fisheries products	21,000,000
Forestry products	43,000,000
Animals and their products.....	55,000,000
Agricultural products	207,000,000
Manufactures	68,000,000
Miscellaneous	2,000,000
	<hr/>
	\$455,000,000

The destination of these products was as follows:

United Kingdom	\$222,000,000
British colonies	24,000,000
	<hr/>
Total to British Empire	\$246,000,000
United States	177,000,000
Netherlands	5,500,000
Belgium	4,800,000
Germany	4,400,000
France	3,800,000
Argentina	2,000,000
Cuba	1,800,000
Japan	1,600,000
Russia	1,400,000
Norway	850,000
Brazil	800,000
Italy	650,000
Porto Rico	500,000
All other countries	3,900,000
	<hr/>
Total to all countries	\$455,000,000

Imports Contingent on Exports

The only exports which might be, theoretically, cut off are those to Germany and Belgium, amounting together to a little over nine million dollars, which would be more than compensated for by the higher value of some of Canada's agricultural products, especially wheat. But on the face of things, Canada cannot buy, at this time, 635 million dollars while exporting only 455 millions. The balance was practically borrowed or represented foreign investments, which cannot be relied upon at present. This means that Canada will have to reduce its foreign purchases by 30 per cent., unless its exports show an increase. Whether or not the loss will fall to each of the countries in proportion to their former sales to Canada has yet to be seen; it does not necessarily follow. Were it so, as far as we are concerned, the situation would mean that Canada would buy from us about 120 million dollars less per annum. The fall in our exports to Canada for the first five months of the war was \$30,800,000. But this may, or may not, continue in the same ratio in the future. Our imports from Canada, during the same months have been:

August, \$4,400,000 more; September, \$2,100,000 more; October, \$200,000 more; November, \$3,700,000 less; December, \$3,700,000 less, or barely \$700,000 less in all.

Judging from these few factors, apparently Canada's exports will not be less in value, but imports will not exceed exports.

We imported \$164,000,000 in the year ending December 31,

1914, from Canada and only \$142,000,000 in the previous year; that is, we bought 22 millions more. On the other hand we exported to Canada 310 million dollars against 403 millions the year before, or a fall of 90 millions. As only 30 millions of these are accounted for during the five months of the war, we lost 60 millions of trade during the first seven months due to other causes.

Wheat Leading Export

The principle article of Canadian exports is wheat. The total quantity exported in the fiscal year ended March 30, 1914, amounted to 126,000,000 bushels valued at \$124,000,000. At present prices (\$1.50 per bushel) it would show an advance of about 65 million dollars, and in all probability the price will go still higher for a time. Every cent of increase in price represents, for Canada, 1¼ million dollars, and it is to be hoped that that country will be able to take full advantage of it. If that be the case, a large part of the loss of its purchasing power because of the stoppage of investments may be offset, in an advantageous way, by increase in value of its production.

Another line which may bring more money to Canada is cattle and their products, as well as horses, now so much in demand. Exports in 1914 (fiscal year) were:

Cattle	\$8,000,000
Horses	2,000,000
Meats	5,000,000
Cheese and butter.....	20,000,000
	<hr/>
	\$35,000,000

These also may increase not less than 50 per cent., making 18 or 20 million dollars more in value.

Metals are an important item; in all the production represents 70 million dollars.

Exports of paper and wood pulp may be increased in value and quantity as shipments of European supplies are difficult and expensive. Paper valued at 13 million dollars and wood pulp valued at seven millions were exported in 1913-14 and these 20 million dollars may be substantially advanced. During the first two months of the war the increase in value of both amounted to about one and one-half million dollars.

Other wood products, which ordinarily represent about 43 million dollars, may not show any advance.

Hides, representing around 10 million dollars, will probably keep up, but show no increase of importance.

Summing up, we believe that Canada's foreign purchasing power may be advanced by some 90 or 95 million dollars, due to the increase in prices of some of its products and eventually also in quantity. But the lack of investments will always mean a loss of as much more. To be conservative, we may say that imports are apt to fall, say, 15 per cent., or 90 million dollars, and that our loss may amount to 60 millions in all. Of course the United Kingdom will buy all the supplies it can in Canada, in preference to any foreign country, and this may help considerably. If our loss of exports is only 60 millions during the year 1915 we may be satisfied.

Good Banking System

Canada has a good and powerful banking system; it is carefully inspected by the Government and it has been adopting all such measures as would tend to further improve it and make it safer and more useful. Currency is based on gold. There are 23 chartered banks, with a capital of 115 million dollars. These banks and the Dominion Government issue notes. The latter alone are legal tender, but after the declaration of war notes of chartered banks were made available to pay liabilities of these banks.

There is no tax on commercial travelers, except for sales of wines, spirits and tobacco, and this only in some of the Provinces.

Canada with a territory larger than that of the United States (3,729,665 square miles) has only 7½ million population, but its potentiality is evidenced by the fact that its exports amount to 455 millions or more than \$60 per capita. Our exports amount

to 2,400 millions for a population of 100 millions, or only \$24 per capita.

Of course, a large part of Canada is unsuitable for cultivation, and its total production can never reach our figures. But in proportion it is a wonderful wealth generator, and when peace is restored and the country can resume its work, it is bound to further develop its natural riches and take its proper place, perhaps the first, in proportionate value of production.

Source of Credit for the United States

Canada was a source of foreign credit for the United States, as its balance of trade was always in our favor. In the calendar year 1913 we sold to Canada 403 million dollars and we bought only 142 millions. This gave us a balance of 261 million dollars. In 1914 our exports amounted to 310 millions and our imports to 164, still leaving a balance of 146 millions, but meaning a net loss of 115 millions, which is very significant.

While we may not expect any large increase of trade at this time, nor is there much room for expansion, as we already had nearly two-thirds of the trade of Canada, the loss of 93 millions of sales is alarming, and needs all our attention. Most of our manufacturers have shown complete unwillingness to extend credit at the moment that all countries urgently demand it, but Canadian manufacturers, although having very much less financial resources than we, in many cases have granted as much time as buyers wanted, meeting, in addition, all their demands. This is worth while thinking about, as it points the way leading to the maintenance and expansion of our foreign trade.

HOW THE TRUCK INDUSTRY TURNS THE WAR TO ACCOUNT

The conflagration now engulfing Europe has proved to be a very constructive element in the American motor truck industry. It is no secret that the industry as a whole required a powerful stimulant before actual hostilities broke out last summer, and the war furnished the stimulant.

It has been estimated that some 10,000 trucks have been purchased by the various governments at war and that a considerable part of them are now in service. The first prices paid by the belligerents were abnormally low, but all recent orders have been at better prices than were indicated in the early dealings. For instance, one company quoted 40 per cent. off list for about fifty trucks for immediate delivery in mid August, and this shipment was actually delivered early in September. Several of the contracts made in August called for concessions from the list level. But subsequently the bidding became so strong that the full list price was obtainable.

The experience of the truck industry in this war, says Rider and Driver, illustrates a very vital truth about its fundamental position. The practice of conceding slices from the list prices had become all too common, and it was a poor buyer indeed who could not secure guarantees for mileage, operation and maintenance that would stagger business concerns in other lines of industry. To be sure, some of the companies maintained prices and refused to make suicidal warranties, but they were the sturdy exceptions.

The result was plain to be seen. Owing to the inadequate return from sales and the excessive cost of standing behind outrageous guarantees, progress in developing the truck was not so great as it would have been under different circumstances. The real advancement was made by the concerns that refused to reduce prices or guarantee operation and maintenance.

And then along came the war, and the demand was exerted upon those companies that made the most available goods. There were a dozen different types purchased in various quantities, but the bulk of the demand was on four companies. However, this demand had a most salutary effect upon all the others. They stepped into the domestic market and found that such radical concessions as they had been accustomed to make were no longer necessary. That meant at least a profitable marketing season, and from top to bottom of the industry the effect has been felt.

It is likely that the general stimulation of the truck industry will result in improving the average quality of the product. If so, the advantages to the public will be great.

It is now confidently promised that the time is at hand when the average truck will be able to deliver 50 miles under load 311 days a year.

This promised progress never could have been made while the manufacturing companies labored along under an ever increasing load of guarantees to deliver mileage and keep the trucks going at a cost that they must have known was below the cost of operation.

Companies now manufacturing and shipping trucks to the warring countries, specifically those in Detroit, Cleveland and Buffalo have received up to February 1 something in excess of \$10,000,000 in foreign gold and are producing trucks for Europe valued at over \$400,000 a day.

If this rate is continued for six months, the "war chest" of the truck makers will contain about \$60,000,000 of gold, or more than the entire receipts of the truck industry in some pretty good years heretofore.

THE RUBBER-TIRED BUS DISTURBS THE TROLLEY

An official of a Los Angeles street railway company recently stated to a committee of the California legislature that it would only be a short time before the auto-bus would drive the trolley car out of business. He is not alone in entertaining this apprehension. Within a few days the mayor of Seattle has opposed a movement for municipal ownership of the street car lines on the ground that the auto-bus would soon supersede them, and the complaint comes from a number of cities, particularly in the West, that street car traffic, and consequently street car profits, have been very much reduced since the advent of the big motor-driven stages.

It is hardly likely that the motor-bus will entirely displace the trolley, for in some lines of service the trolley has great advantages, especially in interurban service, where the continuous runs cover a distance of several miles, and also in the smaller cities where there is no elevated road nor subway, and where the morning and night flow of the population to work and home must be taken care of quickly and in large volume. But the motor-bus undoubtedly will prove a disturbing rival to the trolley in solving certain parts of the city transportation problem. It has this great advantage that it requires neither track nor large and extensive power plant. It also can cover many sections of the city where the trolley could not be introduced profitably. It is also very convenient for the shopper, who can take it at the nearest corner and alight at the store door. And it serves the sightseer pleasantly in taking him through attractive streets where the trolley has not been permitted to enter.

And the auto-bus, with its great weight of 3 to 4 tons and its capacity for 35 to 45 passengers, representing an additional weight of 2 to 3 tons, has been rendered possible, of course, only by reason of the rubber tire.—India Rubber World.

AN "EASY MARK" AMERICAN TRUCK

"It is rather curious to note," says a writer in Commercial Motor (London), "that a certain make of American truck delivered in big quantities to the French Army, is fitted with the regulation type of canvas hood over both body and driver, of a rich yellow tint. The bodies and all other parts of the lorries are painted grey. The only conceivable easier target is the red breeches which the French troops have now almost completely discarded. I happened to be on the road looking for certain convoys, and could never pick out the grey and khaki fleets until I was within a few hundred yards of them. But a long line of yellow was visible two miles away. At short range the grey lorries melted into the surrounding landscape, but that line of yellow canvas was a crying invitation to the enemy's guns."

"ARTIFICIAL" VS. "IMITATION" LEATHER

Newark Tanner Opposes Former as a Misnomer

Among the opponents of leather substitutes there is probably no more uncompromising member of the trade than James B. Reilly, secretary of the Patent and Enameled Leather Manufacturers' Association. He is particularly opposed to the use of the appellation "Artificial leather" as a general or specific designation for coated cloth or other substances made to resemble leather.

In the matter of substitution for leather, however, these cloth substances serve a practical and economic purpose. An appearance of leather is required by public demand, and the lower cost provides an outlet for large quantities of merchandise. The chief evil in such substitution is the temptation to deceive and the depreciation of quality. But for many purposes the imitation leather has effected a much needed saving.

On the subject of a name Mr. Reilly writes interestingly as follows:

Artificial leather is purely psychological, and exists in name only and not in actual substance. That agency has yet to come into existence which can produce, or has produced, artificial leather. Declarations and allegations to the contrary are herewith challenged. Imitation leather substances, it must be admitted, are reaching a high state of development. Artificial leather, however, is nothing more than an extravagant conception of non-existing substance.

Leather cannot be artificially produced any more than can beef, hides or poultry. Calling a substance by a misnomer does not ipso facto produce that substance so called. Leather is the skin of an animal, or any part of such skin or hide, that is tanned, tawed or otherwise dressed or prepared for use. Nothing else is leather, and nothing else can honestly be called leather. To produce an artificial substance is to produce or compose a substance in exact reproduction of the natural substance by art or science, rather than by name, and producing the same or nearly the same results.

To produce a substance in resemblance to something else, such as to coat a piece of cotton fabric with a composition to that of leather, and finish it with a grain effect of somewhat similar character, is to produce something in imitation of the natural substance, as distinguished from, and opposed to, that artificially produced. This is exactly what occurs in the manufacture of leather substitutes. The grain effect of genuine leather is imitated by means of the embossing process, and the coating of the cotton fabric is almost the same as that of leather. Therefore, this combination might properly be termed "imitation," surely not "artificial" leather.

The definition of "imitation" is not interchangeable with that of the word "artificial"; and sanction should not be given to the indiscriminate use or abuse of either term. Instinctively, the term "artificial" as used in connection with leather, unqualifiedly implies that leather is artificially produced. Light, heat and ice are artificially produced and are found in daily use—but not leather. Therefore, the term "artificial" leather is a misnomer, and the idea a fallacy and an absurdity.

The reason for the misuse of the term is, of course, obvious. If put upon the market under their real descriptive titles, leather substitutes would no doubt find less ready sale than they do under the false guise of "artificial leather." There is, oftentimes, a whole lot in a name; the aspect of a thing may be changed considerably by the use of a high-toned appellation. Many manufacturers of leather substitutes are evidently well aware of this fact, and are taking advantage of it in their efforts to perpetrate a fallacy to the fullest extent to which they can "get away" with it. They apparently consider their advertising of so-called "artificial leather" and exaggerated claims in connection therewith, as a sort of "modified honesty"—again a new idea. However, since there is actually no such thing as modified honesty, in advertising or in anything else, it may be safely said that a printed mis-statement is a deliberate lie.

Facts are, sometimes, hateful and despicable things, but insofar as leather is concerned, manufacturers of that product want the public to know the facts.

THE TRADE LOSES AN ILLUSTRIOUS MEMBER

The many activities of Mr. George Norgate Cooper, who died recently at the advanced age of ninety years, are the easiest to trace of those of any past or present member of the industry, says the London Automobile and Carriage Builders Journal, since Mr. Preston has faithfully recorded them as an appendix to the volume of papers read before the Institute, the cost of printing of which was defrayed by Mr. Hooper. On several occasions Mr. Hooper prepared reports on the various exhibitions of carriages which were held in London, Paris, Dublin, and other centers. He read papers before the Institute on many subjects, his most popular theme being that of education—both general and special. He took active interest in the first classes ever held in road carriage building, and when, in later years, the day-school of carriage building was inaugurated he kept in personal touch with the head master, and founded a scholarship which, unhappily, at the present time has been allowed to fall into abeyance owing to the want of enthusiasm on the part of the young men of the trade. Mr. Hooper, as might have been expected, held the position of Master of the Coach-makers Company as well as the presidency of both the Institute of British Carriage Manufacturers and the Master Coach Builders' Benevolent Institution, and in these latter two instances can claim to have been one of the founders of the two institutions. He was a strong supporter of the Temperance movement, and took part in the agitation for the suppression of the opium traffic in China, living long enough to see his views and principles on both subjects justified and vindicated. He was also a man of strong religious convictions. Mr. Hooper was an accomplished draftsman, who gave evidence of his skill in preparing many artistic drawings of finished carriages rather than severely practical working drawings. During many years of his most active endeavors on behalf of the general welfare of the trade, he occupied the position of partner in the leading firm of Hooper & Co., of Victoria Street. Although unable to take much active interest in the trade of late, owing to his advanced years, he made a special effort to attend the Autumnal meeting of the Institute on the occasion of the visit of the French carriage builders, which proved to be his last public appearance among the members of the trade. He, however, cordially supported the work of the Institute and the Benevolent Institution up till the end, and in this issue one reads that his annual subscription was duly recorded. The death of Mr. Hooper should act as a reminder to the younger generation that the trade is in need of workers who will persistently work for the advancement of the trade. If one does not possess the wealth and leisure to engage in so large and varied a programme as that of Mr. Hooper, we may all support the work of others, even if it only extends to putting in an appearance at the general meetings of the representative bodies of the trade.

FISK CO. TO ISSUE ADDITIONAL STOCK

The stockholders of the Fisk Rubber Company, of Chicopee Falls, Mass., at a recent meeting authorized an issue of \$500,000 of additional preferred stock. This stock is to be sold on commission to the public by a banking house in Boston, and the proceeds will be used to supply additional working capital.

On December 31 last some 2,250 shares of preferred stock were retired out of the net profits for the year 1914, in accordance with the provisions governing the issue and retirement of such stock in the Fisk company. The retirement of this stock reduced the working capital to the extent of \$225,000 and the stockholders have considered it advisable to provide additional cash with which to operate in the crude rubber market in view of the active conditions in the rubber trade.

VEHICLE FACTORY COST SYSTEM.

Revised Report as Finally Adopted by the C. B. N. A. Cost Committee.

(Continued from February Issue)

Form No. 7.

COUPON  TAG

GEAR

STYLE

G 109. Order No.

G 109. Shipped

G 109. Set Up

G 109. Finish

G 109. Stripe

G 109. Steel Wool and Wash

G 109. Color Varnish

G 109. Resand

G 109. Reputty

G 109. Lead

G 109. Resand

G 109. Reputty

G 109. Ironed

Style

Explanation Form No. 7

These coupon tags are to be used in connection with the daily time card and where work is done piece work, to serve as a check for amount of piece work done. They should also be turned in where work is done day work to show the amount of work performed by day workers.

Form No. 8.

MANUFACTURING EXPENSE.

Line No.	ITEMS	Assumed Amount
1	Rent or taxes on building and lands.....	250 00
2	Insurance on buildings.....	300 00
3	Depreciation.....	500 00
4	Repairs and maintenance to buildings.....	500 00
5	Power, heat and light.....	1,000 00
6	Repairs and maintenance of equipment.....	500 00
7	Repairs to goods damaged in process.....	150 00
8	Hauling.....	1,000 00
9	Factory supplies.....	750 00
10	Water tax.....	50 00
11	Liability insurance.....	175 00
12	Insurance on all material.....	500 00
13	Insurance on all equipment.....	500 00
14	Drafting material.....	50 00
15	Factory executives.....	4,000 00
16	Factory office salaries.....	2,000 00
17	Factory office stationery, supplies and postage.....	250 00
18	Freight and express in and out.....	2,500 00
19	Company's personal tax.....	150 00
20	Shipping office expense.....	750 00
21	Stock room expense.....	600 00
22	Watchman expense.....	1,000 00
23	Subscription to magazines.....	25 00
24	Dues to associations.....	50 00
25	Cost of goods furnished free.....	100 00
26	Miscellaneous non-productive labor.....	600 00
27	Miscellaneous manufacturing expense items.....	1,750 00
Total manufacturing expense entire plant for one year		\$20,000 00

Manufacturing expense is to be applied on the productive labor only.

Assuming that the total amount of productive labor for one year is \$30,000.00
 And manufacturing expense is 20,000.00
 Then the percentage of manufacturing expense is 66 2/3%.

Explanation Form No. 8

The expense items should be gathered from the following records:

Non-productive labor from the pay-roll.

All money paid out for purchases or other items that are expense items, should be charged direct to such expense.

Any material drawn from general stock room for expense items and which was not originally charged to expense.

Any material drawn from regular stock in department, used for repairs or replacements or other expense purposes as noted on daily time card.

All labor that is not directly applied to the product is non-productive labor.

All material that does not become a visible or physical part of the product is expense material.

Explanation of Manufacturing Expense Items

Line No.

1. Under this heading include rent or taxes on buildings and lands.
2. Under this heading include insurance on building only, and not on material or equipment.
3. Under this heading include depreciation on buildings and equipment.
4. This is self-explanatory.
5. Under this heading include cost of fuel, fireman's wages, engineer's wages, engineer's license, boiler insurance, boiler compound, oils, waste and any other material used by engineer.
6. This is self-explanatory.
7. Under this heading include all expense for repairing goods damaged in process or on which extra labor and material are necessary on account of defects.
8. This is self-explanatory.
9. Under this heading include blacksmith coal, welding compound, emery wheels, buffing wheels, brazing compound, machine drills, files, hack saws, bits, sandpaper, rubbing stone, chamois skins, sponges, rags, brushes, soap, needles, etc.
10. This is self-explanatory.
11. This is self-explanatory.
12. Under this heading include insurance on all material, whether raw, in process or finished.
13. Under this heading include insurance on all tools and machinery and equipment.
14. This is self-explanatory.
15. Under this heading include superintendent, purchasing agent, foremens supervisory time and his assistants; also such portion of official's time as is devoted to manufacture.
16. Under this heading include stock clerks, cost clerks and any other clerical help in those departments.
17. This is self-explanatory.
18. Under this heading do not include freight allowances to customers. Any such deductions or allowances to be deducted from sale price.
19. Under this heading include taxes on chattels, but not on real estate.
20. Under this heading include shipping clerk's time and all expense connected with the shipping office.

21. This is self-explanatory.
22. Under this heading include day and night watchmen.
23. This is self-explanatory.
24. This is self-explanatory.
25. Under this heading include cost of goods furnished to customers free of charge, to replace defective parts.
26. Under this heading include all items of non-productive labor that are not taken care of in any other way under the heading of Manufacturing Expense.
27. Under this heading include all items of miscellaneous Manufacturing Expense that are not taken care of in any other item.

10. Under this heading include amounts paid for space in advertising.
11. Under this heading include all advertising printed matter of any description.
12. Under this heading, include all expense for maintaining show room, such as washing, sweeping, cleaning, etc.
13. This is self-explanatory.
14. Under this heading include all fair and convention exhibits, such as freight to and from convention, railroad fare of officials (but not salesmen), entertainment at conventions, space, souvenirs and necessary refinishing of goods.
15. This is self-explanatory.
16. Under this heading include all expense of entertaining visitors at the home office.
17. This is self-explanatory.
18. This is self-explanatory.
19. This is self-explanatory.
20. This is self-explanatory.
21. Under this heading include all miscellaneous items of Sales and Administrative Expense that have not been taken care of in any other items of S. and A. Expense.

Form No. 9.

SALES AND ADMINISTRATIVE EXPENSES.

Line No.	ITEMS	Assumed Amount
1	Executive salaries	\$ 5,000 00
2	Office salaries	2,800 00
3	Office supplies, stationery and postage.....	500 00
4	Telegraph and telephone.....	150 00
5	Collection and exchange.....	100 00
6	Auditing	200 00
7	Adjustments, allowances and discounts.....	1,200 00
8	Bad debt reserve.....	1,000 00
9	Local legal expense.....	100 00
10	Advertising.....	1,000 00
11	Catalogues, photos and cuts.....	700 00
12	Show room maintenance.....	250 00
13	Sample cases, etc.....	100 00
14	Convention expenses	500 00
15	Donations	100 00
16	Entertainment	100 00
17	Mercantile agency	200 00
18	Salesmen's salaries	5,000 00
19	Salesmen's travelling expenses	5,000 00
20	Salesmen's commissions	5,000 00
21	Miscellaneous sales and administrative expense.....	1,000 00
Total Sales and Administrative Expense for one year..		\$30,000 00

Sales and Administrative Expense is to be applied to Total Sales. Assuming that the total sales for one year equal.....\$150,000.00 And the Sales and Administrative Expense equal..... 30,000.00 Then the sales expense is 20% of the selling price.

Example of applying selling expense in figuring cost on one job:

Material	\$40.00
Labor	18.00
Manufacturing expense, 66 2/3% of productive labor per No. 8 Form.....	12.00

Total factory cost

If the selling expense is 20%, and a profit of 10% is desired, then the \$70.00 factory cost represents 70% of the selling price. If \$70.00 is 70%, then 100% would be equal to \$100, which is the selling price.

Selling Expense 20% equals.....	20.00
	80.00
Factory Cost	70.00
Profit	10.00 or 10% of selling price.

Explanation of Sales and Administrative Expenses

- Line No.
1. Under this heading include all official's salaries.
2. Under this heading include all clerical help, such as book-keeper, bill clerks, stenographers, cashier, office boy and any other clerical help in the office.
3. This is self-explanatory.
4. This is self-explanatory.
5. Under this heading include outside attorneys for making collections, but not your local attorney's charges.
6. This is self-explanatory.
7. Under this heading include any reductions or allowances made to customers and also any discounts allowed.
8. This is self-explanatory.
9. Under this heading include your local attorney's fees only.

Form No. 10. MATERIAL AND LABOR COSTS.

100 Buggy Bodies.

The material and labor costs on each job should be compiled as per this form. It shows complete list of material and labor required for a complete buggy and will serve as an example. Of course, the manufacturer's individual styles will no doubt vary somewhat from this list, but this list can be used as a guide, which it is intended to be.

MATERIAL				LABOR	
Quantity	Description	Price	Cost	Operation	Amount
100	Flano Bodies in white...			Sanding	
	Primer			Priming	
	Guide coat			Leading	
	Putty			Sanding	
	Rough stuff, five coats.....			Glazing	
	Ironing			Filling, five coats.....	
	If you iron body at this point, necessary labor and material should be included.			Rubbing roughstuff	
	Inside black			Sand and clean up	
	Inside black			Painting inside	
	Putty			Painting bottoms	
	Flat color			Glazing	
	Rubbing varnish			Sanding putty	
	Rubbing varnish, 2nd coat			Coloring	
	Inside black			Varnishing	
	Finishing varnish			Rubbing varnish	
				Varnishing, 2nd coat.....	
				Bug. for finish	
				Finishing inside	
				Finishing outside	
	Total Body Material.....			Total Body Labor.....	

Form No. 10.—Continued.

MATERIAL AND LABOR COSTS.

100 Buggy Seats.

MATERIAL				LABOR	
Quantity	Description	Price	Cost	Operation	Amount
100	Buggy Seats in the white.			Sanding	
	Primer			Priming	
	Guide coat			Leading	
	Putty			Sanding	
	Rough stuff, five coats.....			Glazing	
	Inside black			Filling, five coats.....	
	Putty			Rubbing roughstuff	
	Flat color			Sand and clean up	
	Rubbing varnish			Painting inside	
	Rubbing varnish			Glazing	
	Ironing			Sanding putty	
100	Pr. back corner irons.....			Coloring	
200	Shifting rail eyes.....			Varnishing	
100	Pr. frt. top irons and seat			Rubbing varnish	
	Brace			Varnishing, 2nd coat.....	
100	Pr. arm rails, Jap.....			Rubbing to finish.....	
1,200	Fin head seat bolts.....			Ironing seat	
3,000	Flat head bright screws..			Touching up	
	Striping color			Striping	
	Finishing varnish			Finishing	
	Total Seat Material.....			Total Seat Labor.....	

NOTE.—If seats are trimmed before being finished, labor of taking seats to Trimming Shop and returning to Finishing Room should be included in costs, providing it is not treated as direct labor.

Form No. 10.—Continued.

MATERIAL AND LABOR COSTS.

100 Regular Buggy Gears.

MATERIAL				LABOR	
Quantity	Description	Price	Cost	Operation	Amount
100	Front axles less boxes...			Taking off boxes and washers...	
100	Front axle beds in white.			Fitting and setting...	
	Primer				
	Putty			Grinding	
600	Axle clips			Fitting	
100	Pair coupling clips			Glueing	
600	1/4-inch clip ties			Sanding and polishing	
200	5/8-inch clip ties				
	Fifth wheel parts necessary for front axle			Priming	
100	Rear axles, less boxes			Glazing	
100	Rear axle beds in white				
	Primer			Putting up front axle	
	Putty			Taking off boxes and washers	
200	Reach in white			Fitting and setting	
	Primer			Grinding	
200	Reach plates				
	Fifth wheel parts necessary for putting up reaches and head blocks			Fitting	
300	Rear perch connections			Glueing	
1,200	1 1/2-inch reach bolts			Sanding and polishing	
400	1 1/2-inch reach bolts			Priming	
200	2-inch com. carriage bolts				
100	Head blocks in white			Glazing	
	Primer			Priming	
200	1 1/2-inch tire head bolts				
200	Washers for above			Cutting to length	
100	Front springs			Punching holes	
100	Rear springs				
	Lead			Truing fifth wheel parts	
100	Sets Bailey body loops			Labor putting up reaches and head blocks	
400	Herbrand short spring clips			Priming	
400	Plain clip ties				
200	Brewster side bar clips			Leading springs	
400	Rear axle clips			Putting up springs	
100	Pair stay braces				
400	1 1/2-inch reach bolts			Labor Putting up gear	
100	Set 3-inch, 3-piece saddle clips			Sanding	
100	Set 1 1/2-inch, 3-piece saddle clips			Glazing	
400	1/2-inch clip ties			Filling	
200	3/4-inch clip ties				
100	King bolts			Varnishing	
100	Fifth wheel sets parts necessary for assembling gear			Rubbing	
	Putty			Striping	
	Ground coat			Finishing	
	Color varnish				
	Steel wool				
	Striping color				
	Finishing varnish				
	Total Gear Material			Total Gear Labor	

Form No. 10.—Continued.

MATERIAL AND LABOR COSTS.

100 Sets of Wheels.

MATERIAL				LABOR	
Quantity	Description	Price	Cost	Operation	Amount
100	Sets of wheels in white			Sanding	
	Primer			Priming	
				Chipping and Sawing	
100	Sets round edge steel tire			Cutting off	
				Bending	
				Putting on	
7,200	Tire bolts			Setting	
				Welding	
5,400	Tire bolt washers			Truing	
				Inspecting	
800	Felloe plates			Drilling	
				Countersinking	
100	Sets axle boxes			Bolting	
				Screwing up	
	Lead			Cutting off	
	Putty			Boring	
				Boxing	
	Ground coat			Leading	
				Sanding	
	Color varnish			Glazing	
				Sanding	
	Steel wool			Filling	
				Varnishing	
	Striping color			Rubbing	
				Touching up	
	Finishing varnish			Striping	
				Finishing	
	Total Wheel Material			Total Wheel Labor	

Form No. 10.—Continued.

MATERIAL AND LABOR COSTS.

100 Pair of Shafts.

MATERIAL				LABOR	
Quantity	Description	Price	Cost	Operation	Amount
100	Pair of shafts in the white—ironed			Priming	
	Primer			Putting on Single trees	
	Putty			Sanding	
	Ground coat			Puttying	
	Color varnish				
	Striping color			Applying	
	Finishing varnish				
200	Patent leather point leathers			Varnishing	
14,000	2 1/2-oz. Swede's trimmers' tacks				
200	Patent leather shaft spots			Mossing	
2,000	2 1/2-oz. Swede's trimmers' tacks			Striping	
100	Sets keeper straps, including rat tails			Finishing	
1,600	12-oz. Swede's tacks				
400	12-oz. Jap. lining nails			Labor trimming shafts	
200	Metal shaft tips				
200	6-oz. Jap. lining nails			Wrapping	
200	Hold backs				
200	1/2-inch, No. 8 drive screws			Tagging out and shipping	
400	Paraffine shaft wrapping paper				
	Shaft wrapping burlap				
200	7-ft. 6-in. shaft slats				
100	3-ft. 6-in. shaft slats				
	3-ply jute wrapping twine				
	Total Shaft Material			Total Shaft Labor	

Form No. 10.—Continued.

MATERIAL AND LABOR COSTS.

100 Buggy Tops.

MATERIAL				LABOR	
Quantity	Description	Price	Cost	Operation	Amount
100	Shifting rails Jap.			Shaving and driving up bows	
100	Sets 4-bow sockets, Jap.			Cutting	
400	Pieces wood bows				
100	Sets buggy Thomas props			Stitching headlining	
1,600	Flat head bright screws				
200	Pair buggy jts., Jap.			Cutting	
800	Jap. prop nuts				
400	Pressed leather washers			Cutting	
100	Pair prop blocks				
200	Round hole prop block washers			Cutting	
200	Square hole prop block washers				
100	Pair concealed jts.			Cutting	
400	Flat head bright screws				
1,200	No. 13 Jap. rivet knobs			Cutting	
1,000	3/4-inch Jap. drive knobs				
100	Pieces headlining			Cutting	
300	Pieces welt				
	Swede's tacks			Cutting	
	Thread				
200	Strainer straps			Pasting stays	
200	Pieces sheeting for pads				
	Excelsior			Stitching stays	
	Swede's trimmers' tacks				
500	Pieces headlining for side lace			Putting in knobs and buckle loops	
200	Pieces side lace buckram				
	Pasting lace			Cutting	
	Stitching lace				
	Thread				
	Swede's trimmers' tacks			Cutting	
1,200	14-inch Jap. saddle nails				
100	Rag board comb. strips			Cutting	
300	Roll-up straps				
	Swede's trimmers' tacks			Pasting	
200	3/4-inch Jap. drive knobs				
200	Pieces leather back stay patterns			Stitching stays	
200	Pieces double buckram			Putting on back stay straps	
	Thread				
400	Single buckle loops			Cutting	
400	Back stay knobs				
200	Pieces stay linings			Marking	
300	Pieces foundation				
200	Pieces wadding				
	Thread			Cutting	
200	Back stay straps				
200	Tubular rivets			Labor pasting	
	Swede's trimmers' tacks				
100	Pieces back curtain material			Punching and putting in lights	
100	Pieces back curtain lining			Stitching	
100	Pieces reinforcing material for bottom			Trimming back curtain	
100	Back curtain lights			Cutting	
	Thread				
400	No. 2 knob eyelets			Cutting	

Form No. 10.—Continued.

MATERIAL AND LABOR COSTS.
Buggy Tops—Continued.

MATERIAL				LABOR	
Quantity	Description	Price	Cost	Operation	Amount
400	Back curtain straw for buckles			Cutting	
	Swede's trimmers' tacks			Cutting	
200	Pieces enamel leather quarters			Cutting	
200	Pieces buckram reinforcing			Pasting quarters	
200	Pieces dust pocket material			Stitching	
200	Pieces corner patches				
200	Pieces corner patch lining			Marking quarters	
100	Thread			Cutting	
	Pieces deck covering material			Marking deck	
	Thread				
	Swede's trimmers' tacks			Creasing deck	
400	Saddle nails			Stitching	
100	Tubular rivets			Cutting	
100	Front valances			Pasting curtains	
	back bindings			Stitching	
	Swede's trimmers' tacks			Labor assembling and building top	
	Jap saddle nails				
100	Pairs side curtain material				
	Thread				
2,000	Knob eyelets				
	Total Top Material			Total Top Labor	

Form No. 10.—Continued.

MATERIAL AND LABOR COSTS.
100 Buggy Backs.

MATERIAL				LABOR	
Quantity	Description	Price	Cost	Operation	Amount
100	Leather back patterns			Punching to mold	
2,600	22-line 1-inch blk. clinch buttons				
100	Back foundations—Excelsior or wood wool or hair			Creasing	
100	Rag board back strips				
2,600	Tufting washers			Labor assembling material	
100	Pieces back binding material				
3,000	Swede's tacks			Making on the mould	
1,000	3/4-inch No. 15 needle point nails			Cutting back material	
	Rack springs				
	Double point tacks				
	Swede's trimmers' tacks				
3,000	Comb welt and binding			Hanging in back	
	Finishing nails				
200	Leather seat end patterns				
200	Pieces breakovers			Hanging in ends	
	Wadding or excelsior filling				
	Swede's trimmers' tacks				
3,000	Comb welt and binding				
	Finishing nails				
	Total back material			Total Back Labor	

Form No. 10.—Continued.

MATERIAL AND LABOR COSTS.
100 Buggy Cushions.

MATERIAL				LABOR	
Quantity	Description	Price	Cost	Operation	Amount
100	Leather cushion patterns			Punching to mould	
2,100	22-line, 1-inch blk. clinch buttons				
100	Cushion foundations—Excelsior, wood wool or hair			Creasing	
2,100	Tufting washers			Labor assembling materials	
100	Cushion frames			Cutting cushion material	
500	3-spring cushion strips				
1,000	Brads			Putting up cushion frames	
	Swede's trimmers' tacks				
100	Green leather fall patterns			Making on the mould	
100	Fall linings			Pasting	
	Thread				
100	Fall weights			Stitching	
100	Green lea. cush. facings				
100	Pieces welt			Trimming falls	
400	Breakovers				
200	Pieces cushion finishing material			Putting in	
	Swede's trimmers' tacks				
100	Pieces cush. facing pads			Finishing cushion	
	Total Cushion Material			Total Cushion Labor	

Form No. 10.—Continued.

MATERIAL AND LABOR COSTS.
Assembling Room—Setting Up 100 Jobs.

MATERIAL				LABOR	
Quantity	Description	Price	Cost	Operation	Amount
1,600	*Bolts of various sizes			Enameling heads	
	Air-drying japan			Cutting in	
100	Pair wear irons, Jap.				
100	Pair steps, Jap.			Punching plates	
100	Toe rails, Jap.				
100	Pair dash feet, Jap.			Blackening plates	
	Flat head bright screws			Cutting	
200	Body plates			Binding carpet	
	Air-drying japan				
100	Dashes			Cutting	
100	Whip sockets			Binding toe carpet	
100	Pair dash braces, Jap.				
200	Fin. head bolts			Labor bringing body, seat, top, trimmings and wheels to set-up floor	
100	Carpets				
	Thread				
100	Toe carpets			Labor ironing up and setting up job complete, and hang-off top	
	Thread				
100	Boots, mfg'd complete			Labor delivering to crating room	
200	Boot springs				
400	Staples				
100	Storm aprons, mfg'd complete				
100	Pair seat handles, Jap.				
400	Round head screws				
100	Wrenches, Jap.				
100	Pair quick shifters or anti-rattlers				
100	Name plates				
200	nails for attaching name plates				
400	Seat rods				
200	Common carriage bolts				
200	Jap. drive knobs				
	Total Assembling Material			Total Assembling Labor	

* N. E.—Bolts should be itemized and prices according to kind and size used.

Form No. 10.—Continued.

MATERIAL AND LABOR COSTS.
Crating 100 Jobs.

All crating should be listed and exact number of feet figured out from list and price according to the way you are crating your buggies, for example:

MATERIAL				LABOR	
Quantity	Description	Price	Cost	Operation	Amount
600	Regular L Crates—Sides			Nailing and delivering to crating room	
	Pieces 3/4 x 3 x 5' 5".....				
	Surface measure, 812'				
200	Pieces 3/4 x 4 x 5' 5".....				
	Surface measure, 361'				
200	Pieces 3/4 x 3 x 3' 4".....				
	Surface measure, 167'				
400	Pieces 1 x 4 x 4' 0".....			Labor packing and nailing up.	
	Surface measure, 533'				
200	Pieces 1 x 4 x 1' 11".....				
	Surface measure, 128'				
200	Pieces 1 x 4 x 3' 2".....				
	Surface measure, 211'				
9,000	Cement coated nails				
1,000	Pieces 3/4 x 3 x 4' 11".....				
	Surface measure, 1,229'				
700	Pieces 3/4 x 4 x 4' 11".....				
	Surface measure, 1,147'				
100	Pieces 3/4 x 5 x 4' 11".....				
	Surface measure, 205'				
100	Pieces 3/4 x 3 x 5' 8".....				
	Surface measure, 142'				
100	Pieces 3/4 x 3 x 4' 4".....				
	Surface measure, 108'				
600	Pieces 1 x 3 x 4' 9".....				
	Surface measure, 713'				
200	Pieces 1 x 3 x 5' 5".....				
	Surface measure, 271'				
1,500	Cement coated nails				
200	Clashing pins				
200	16-in. bale ties cross head				
200	18-in. bale ties cross head				
	Tarred lath yarn				
	Swede's trimmers' tacks				
200	Tack-in strips				
	Paraffine wrapping paper				
500	Wheel slats				
100	Paper covers				
	Total Crating Material			Total Crating Labor	

Form No. 11. ASSEMBLED OR COMPLETE COSTS.

Part	Material	Labor	Manufacturing Expense
Body			
Seat			
Gear			
Wheels			
Shafts			
Tops			
Backs			
Cushions			
Assembling			
Crating			
Totals	\$40.00	\$18.00	\$12.00

Summary

Material	\$40.00
Labor	18.00
Manufacturing Expense	12.00
	<hr/>
Factory Cost	\$70.00
Sales and Administrative Expense.....	20.00
	<hr/>
Total Cost	\$90.00

In conclusion, it must be borne in mind, that no cut and dried system can be laid down bodily in any plant and prove a success. At best, the approved system can serve only as the basic plan from which to work and the one hundred and one details must be carefully considered in each plant to guarantee the success of the whole.

There is no question whatever that this system with intelligent application can be made to fit the conditions of any carriage plant with profit.

W. A. SAYERS, Chairman,
 J. D. DORT,
 P. E. EBRENZ,
 J. W. FULREADER,
 Committee.

REPORT NO. 2

This report should undoubtedly be preceded by a few words in explanation.

Every manufacturer's product when finished represents the united efforts of an organization, the size of which should always be in proportion to the volume of its business. Therefore, every individual article manufactured should bear its proportion of the indirect cost as well as the cost of material and labor that can be readily and easily calculated.

Custom has made it advisable, and furthermore, it is most convenient to include the indirect cost represented in the finished product of any manufacturing concern in proportion to the value of the direct cost according to the relative proportions of these two factors represented by the business done during a given period, which period it is always best to figure as one year.

It is taken for granted that all manufacturing concerns, no matter how small, have some system of keeping records of their various expenses. Therefore, in going over their accounts there should be no trouble in listing all of these expenditures during the year under one or the other of two heads. These two divisions are called DIRECT COST and INDIRECT COST.

Direct cost is more easily defined as being the expense represented in a finished product that can be easily calculated by means of visible materials and actual labor represented in finish-

ing that particular item.

Indirect cost is more easily defined as being that portion of the expense of any business that must necessarily enter into the cost of manufacture, but the material used is not visible, and the labor paid for did not enter directly in any particular operation.

It is most convenient, therefore, to first go over one complete vehicle and itemize all the material used to produce this particular vehicle. We will also itemize all the different labor operations that enter directly into the production of this vehicle. These labor operations may be taken care of on a piece-work basis, or you may be paying one man by the day to do many of the various operations; but in any event the labor represented in the cost of each vehicle and figured as direct labor cost is cash labor as can be readily accounted for.

The list of materials and labor operations that enter directly into the cost of one vehicle will be found in Report No. 1, under the head of "Material and Labor Costs," and these should be figured as direct cost.

After you have decided all the items that you will figure in your cost as direct cost items according to the above list, you would go over the rest of your accounts and separate from the direct cost items the indirect cost items.

The following is a list of the possible indirect cost items in every business organization. While some of these items may not be used in every individual factory and they may be using some other items of similar nature to take their place, we believe this list showing the character that represents indirect cost will be a fairly good illustration and sufficient guide line for almost any manufacturer to follow:

- Legal rate of interest on investment or capital stock.
- Taxes of all kinds.
- Repairs to buildings.
- Repairs to equipment.
- Repairs to machinery.
- Repairs to tools.
- Repairs to furniture and fixtures.
- Depreciation in inventory value of all real estate, buildings, equipment, machinery and tools.
- Interest on indebtedness.
- Insurance to building, equipment, or contents.
- Employees' sick and accident allowances or insurances.
- Supplies of all kinds, such as tools that wear out in the regular course of individual operations like:
 - Anvil tools.
 - Drills.
 - Files.
 - Needles.
 - Babbit.
 - Dies.
 - and all other items of a similar nature.
 - Beeswax.
 - Boiler Compound.
 - Brooms.
 - Brushes.
 - Coal smithing and steam.
 - Drilling Soap.
 - Emery Dust.
 - Emery Cloth.
 - Emery Paper.
 - Emery Wheels.
 - Emery Wheel Dressers.
 - Paste.
 - Soda.
 - Waste.
 - Rubbing Brick.
 - Pumice Stone.
 - Sand Paper.
 - Steel Wool.
 - Top Dressing.
 - Varnish Strainers.
 - and any other similar items that are necessary for the conduct of your business.
- Packing.
- Rope.
- Belt.
- Belt Repairs.
- Hammer Handles.
- Punches.
- Glue.
- Chamois.
- Lanterns.
- Coke.
- Matches.
- Dusters.
- Tool Steel.
- Lye.
- Machine Oil.
- Kerosene Oil.
- Stationery of all kinds.
- Cushion Tufting Pins.
- Clips.
- Electric Light Fixtures.
- Lamps.
- Fuse Plugs, etc.
- Hose.
- Toilet Paper.

All power and lighting expenses, water bills, etc.

Repairs to all direct cost material during the actual course of construction due to defective material or careless workmanship during any operation.

All repairs to finished product that has already been in the hands of your customers and is necessary to furnish free of charge.

All indirect labor, such as salaries of all officials, superintendents, clerks, foremen and assistants, day and night watchmen, engineers, and all other labor throughout the organization of whatever nature that has not already been computed as the direct labor cost in the above list.

Carloading and dray expenses.

Freight on inbound material.

Freight allowed on finished product should always be taken care of in the selling price, in addition to the manufacturer's cost.

Advertising of all kinds, such as catalogues, circulars, half tones, electrotypes, souvenirs, price-lists, signs, exhibit expenses, or any other special advertising of a similar nature.

Commissions, or salesmen's salaries and expenses.

Entertainment expenses of all kinds. All traveling expenses, hotel expenses, etc., of any representative of the organization on company business.

Transfer and warehouse expenses if any.

Collections and attorney fees. Commercial agency expenses. Loss in bad accounts.

Telegraph and telephone expenses.

Rebates or allowances.

And any other expenses that may arise in the conduct of your business.

After figuring the total of the direct cost accounts and of the indirect cost accounts you should add to the total direct cost of each item of your finished product a percentage equal in proportion of all the indirect cost items to the direct cost items. This to be computed as follows:

Supposing that the total of all the direct cost accounts, during one year, amount to.....	\$100,000.00
The total of all indirect cost accounts amounts to....	25,000.00
Then the proportion of indirect cost to direct cost would be	25%.
Therefore, if the direct cost of this finished vehicle, as computed according to the foregoing list, is.....	\$40.00
Then the indirect cost represented in the finished vehicle would be 25% of \$40.00, or.....	10.00

Making the total cost of this finished product.....\$50.00

This should be your guiding line and the basis from which you would arrive at a selling price according to the desired percentage of profit.

NATIONAL FOREST FIRES CAUSED LOSS OF \$677,816 IN 1914

Fire on the national forests of the west in 1914 caused a loss to the Government of not quite 340,000,000 board feet of merchantable timber, valued at \$307,303, and of reproduction, or young growth of trees, valued at \$192,408, according to statistics just compiled by the forest service. There were 6,605 fires, of which only 1,545 burned over an area of ten acres or more. About 77 per cent. of all the fires did damage of less than \$100 each. In addition to the losses suffered by the Government, timber on State and private lands within the forests, totaling 228,008,000 board feet and valued at \$175,302, was lost. The total area burned over was 690,240 acres, of which 310,583 acres were State and private lands.

Notwithstanding that it was an exceptionally bad year for fires, on account of high temperatures, heavy winds, and prolonged drought, the average loss per fire was \$103, as against \$131 in 1911, when there were only about half as many fires. Eighty-five per cent. of the total loss was caused by fires in Idaho, Montana, Oregon and Washington, where more than

half the timber in all the national forests stands. Less than one-tenth of one per cent. of this timber was affected. Of the 6,605 fires reported, 3,691, or 55.9 per cent., occurred in these States, and of the 99 fires causing losses of more than \$1,000 each, 81 were in this region.

Lightning was the chief cause, starting 2,032 fires; campers came next with 1,126, followed closely by railroad locomotives, with 1,110. Incendiaries lighted 470 and the rest were attributed to brush burning, sawmills, etc., or their origin was unknown.

COURSES OFFERED TO AUTOMOBILE DRIVERS BY EXTENSION DIVISION

The Extension division of the University of Wisconsin at Madison, has prepared and is offering to Wisconsin motorists a very interesting and effective course of lectures on the gasoline automobile. The university hopes with this course of lectures to reach every important city in the State. Six experienced mechanical engineers of the staff of the Extension division are available to give the course in different parts of Wisconsin.

The instruction is given in a series of 10 lectures, with lantern slides, models, and other demonstrations necessary to make clear the principles of motor car construction and operation. To supplement the lectures, printed pamphlets will be given out so that the students will have this material in convenient form for reference. This also removes the annoyance of having to take notes and enables the auditors to concentrate their full attention on the lecturer. The subjects of the lectures are as follows:

Types of Machines; Arrangement and Construction of Chassis.

The Power Plant; the Gasoline Engine.

Fuels and Carburetors.

Electrical Principles; Battery Ignition Systems.

Magneto Ignition Systems.

Lubrication; Cooling Systems.

Power Plant Groups; Self Starters.

Transmission Systems.

Motor Car Troubles and Their Remedies.

Driving; Selecting a Car.

Classes are already under way in several cities and one is now being organized in Milwaukee.

FROM AN ENGLISH VIEWPOINT

An American journal which prides itself on the fact that it is "the only exclusive horse-drawn vehicle trade journal," makes the curious lapse of devoting more than four pages to an article on motoring. A perusal of the advertising pages also goes to show that motor-seat springs, motor-car paints, and varnish, chassis springs, motor bodies, cape hood material, motor trailers, and so on, are considered as being within the purview of a journal which devotes itself entirely to horse-drawn vehicles. On the whole, we think it would be better to admit that the automobile had really arrived, and deal with each branch of the vehicle industry according to the amount of business done.—Automobile and Carriage Builders Journal.

WAGON FIRM TO MAKE LADDERS

The Pekin Wagon Co., of Pekin, Ill., has taken over the plant and business of the Safety Folding Ladder Co. and will pay the latter concern a royalty on the business. The Safety folding ladders have been on the market only a comparatively short time, but have received much favor and the business has developed extensively. The product can, it is figured, be manufactured much more economically with the wagon company's facilities than from a separate factory. The business can also be handled by the sales force of the wagon company, which will reduce materially the cost of carrying on the business.

MILITARY STUDENTS TO DRIVE WAR CARS OVER LINCOLN HIGHWAY

Ten military automobiles are in the process of construction by the students of the Northwestern Military and Naval Academy at Lake Geneva, Wis., and some time in June or July these cars, driven by students and accompanied by officers of the United States army, will follow the Lincoln Highway from Chicago to the Pacific coast. The tour is a most important one as its purpose is to demonstrate to the Government the utility of this type of gasoline vehicle.

The cars include two wireless, one field kitchen, one ambulance and field hospital combined, one officers' reconnaissance car, one car for the transportation of light field artillery, one armored car, two balloon destroyers, and one engineer's car.

Col. R. P. Davidson, superintendent of the academy at Lake Geneva, said: "The automobile corps of our institution plans on spending several months during the coming summer in carrying out some extensive experiments with different types of military cars. In the course of these experiments we expect to make a cross country trip to San Francisco, camping along the road and maintaining field conditions. The detachment will employ many new features in the way of equipment and will give the whole question of the military automobile a very thorough test as applied to the roads and conditions of the United States. The result of these experiences will be reported to the United States Government."

C. M. N. A. IS NOW DEFUNCT

The Cyclecar Manufacturers National Association has practically given up the ghost, at least under that name. President W. H. McIntyre who is not now connected with the business, informed secretary F. Ed. Spooner that he could see no reason for holding a meeting. Most of the officers who were elected last year are not now in the business, or at least not active in the light-car field. Many of the manufacturers of light cars are members of the National Automobile Chamber of Commerce, and many of those in the field will join that body. Activities of the Cyclecar Manufacturers National Association ceased shortly after the meeting in Detroit which followed the meeting of July 4 and 5 at Detroit, owing to lack of funds. For a time an active publicity campaign was carried on by the secretary. With the passing of the great majority of the cyclecars, and the coming of the larger series of light cars, the real reason for an individual organization passed.

FOREST NOTES

More than nine million young trees and ten thousand pounds of seed were planted on the national forests in 1914.

At least 25 per cent. of the larch timber over large areas in eastern Oregon has been killed or weakened by mistletoe, and the forest service is taking steps to combat the pest.

Success has followed forest planting on the sandhills of Nebraska. Jack pines planted there by the Government forest service ten years ago now have a height of over 15 feet and a diameter of 4 inches.

Increasing use of the national forests by local farmers and settlers to supply their needs for timber is shown in the fact that small timber sales on the forests numbered 8,398 in 1914, against 6,182 the previous year.

WHEEL TAX BILL IN NEW JERSEY

The wheel tax bill, which has been drawn up under the supervision of the legislative committee of the Associated Automobile Clubs of New Jersey by Judge W. E. Turton was approved by that organization recently. The bill in brief, calls for a wheel tax to be placed upon all horse or other animal-drawn vehicles using the highways, with the exception of agricultural implements. The purpose of the bill is to help pro-

vide more money for the upkeep of the roads.

Three classes of animal-drawn vehicles are provided for. A \$1 annual tax is provided for vehicles with a carrying capacity of 1,000 pounds or less; the second class embraces vehicles with a capacity of more than 1,000 pounds and up to 4 tons, on which the tax has been set at \$2, while the third class covers vehicles having a carrying capacity of more than 4 tons, for which the tax is \$4 per annum.

LARGE WAR ORDERS FOR WAGONS

According to reports published in the daily press on March 2 a motor car company in Detroit has received an order for 1,200 trucks from one of the belligerents. Another sold several hundred, and a third has orders for its output the rest of the year.

Kenosha, Racine and Chicago wagonmakers will split a \$716,000 order for baggage and forge wagons for the allied armies in Europe. Formal notice says that the purchasing agents of the French Government in New York had let the contract for 2,200 wagons to the Bain Wagon Company of Kenosha, the Mitchell Wagon Company of Racine, and the Peter Schutler Company of Chicago.

GREAT EXPECTATIONS FROM ANOTHER HORSE SUBSTITUTE

The manufacture of an invention of F. N. Martindale, of Indianapolis, was begun in Franklin, Ind., recently. It is a device called utimotor. It is a motor attachment adjustable for any horse drawn vehicle, which makes a practical motor car out of any vehicle by merely attaching the device. Martindale expects to have 200 men working at the plant within the next three months.

A "TWO MINUTE" TIRE RIM

A new tire rim has been invented and patented by F. J. Demareth, of Milwaukee, Wisconsin, to manufacture and market which a company is now being formed in that city. This rim, which is to be known as the "Two Minute" quick detachable clincher tire rim, is simple in operation. It is in two parts, one the rim proper and the other an outside flange. The flange is connected with the wheel by means of six lugs and bolts, which can be removed with the fingers. In changing tires these lugs and nuts are slipped off and the flange comes easily. The tire is then slipped over the rim, the flange replaced and the nuts put back. The inflation of the tire causes the nuts to hold securely.

WILL MAKE "BADGER" TIRES

Wisconsin Tire Co. is the title of a corporation organized in Milwaukee, Wis., with \$40,000 capital, to engage in the manufacture and sale of automobile tires. The officers of the new company, which will have its offices at 188-192 Eighth Street, are: President, Dr. G. A. Bading, Mayor of Milwaukee; vice-president, J. A. Werwinski, South Bend, Indiana; secretary, Louis M. Kotecki, city controller; treasurer, Joseph P. Carney, city treasurer; general manager, Fred G. Simmons, city commissioner of public works. The tires the company will make will bear the trade mark "Badger."

LAY AND LANE ARE BANKRUPT

Frank B. Lay, Sr., and M. Henry Lane, former officers of the Michigan Buggy Co., Kalamazoo, Mich., which failed about two years ago, have been declared bankrupts by Judge Sessions of the United States District Court at Grand Rapids. Both men withdrew their answers and demurrers of the bankruptcy proceedings started against them as individuals some time ago.

FRANCE SPENDS DOLLAR A HEAD FOR ROAD UPKEEP

While the appropriation for roads in New York state is generally considered a heavy one, it is really small as compared with the sum the French republic spends annually on road maintenance alone. New York appropriations are for the construction of roads, with little or no provision for maintenance, while to the annual expenditures of \$45,000,000 for maintenance, the French authorities add some \$850,000 for the construction of new roadways. M. Jean de Puligny, chief engineer of roads and bridges in France, in an address at the recent Roads Convention of the American Automobile Association, in Washington, gave the following figures and stated that France is thus spending \$1 per head annually for road maintenance. The French expert's address was in part as follows:

"France is about four times as large as the state of New York, its population is a little more than four times the state of New York; consequently with a population slightly over 9,000,000 in 1910, it means that this state would have an annual expenditure of \$9,000,000 for road maintenance. This does not include road construction by any means.

"During 1912, 29 of the states of the union expended \$62,691,425 on the construction of roads. The total population of these states is 61,261,000, so that the expenditure in these states figures out at practically at \$1 per head. The majority of these states, however, were experiencing abnormal road expenditures, which expenditures will have to be continued for some years. France spends her \$1 per head practically on road maintenance and these states have been spending \$1 per head practically on road construction. Many of the states in your country have not yet learned the lessons of road maintenance, but if it is on a par with that in France it will practically mean a sum equal to that used on construction.

"The original cost of construction of French roads was \$12,040 per mile for a hard macadam surface. Hard road construction, and the agitation for good roads in France began 150 years ago, under Napoleon I, and the beginning of the present network of French roads radiating from Paris dates from 100 years ago. Most of the roads in France, even the earliest, were of macadam construction.

"France has to date 340,000 miles of roads, and in the last century has spent \$1,300,000,000 on these. Of this amount \$400,000 has been supplied by the central government to the heads of the roads departments throughout the country for a period of 70 years, name, 1820 to 1897. Since 1890 the work has been going on at a slower pace with smaller appropriations, most of the useful work having been done prior to that date. This means that the central government of France during those seven years appropriated \$6,000,000 a year in the building of roads. During that time the appropriation for building smaller roads was approximately the same as that for maintaining the national highways. Up to the opening of the European war, the French government was spending \$45,000,000 for maintenance alone."

J. A. MORONEY BECOMES MANAGER OF GOOD-YEAR CARRIAGE TIRE DEPARTMENT

The Goodyear Tire and Rubber Co. announces the appointment of J. A. Moroney as sales manager of its carriage tire department. Mr. Moroney succeeds Marshall E. Morris, who was some time ago made manager of the Goodyear Pacific coast district.

Mr. Moroney came to the Goodyear home offices over a year ago from St. Louis, where he was branch manager for the company, and since then has been working as a special representative of the carriage tire department. He is known to every carriage manufacturer in the United States, and has hosts of friends in the trade who will be glad to learn of his promotion.

ANNUAL MEETING OF RACINE RUBBER CO.

At the annual meeting of stockholders of the Racine Rubber Co., of Racine, Wis., the total earnings for the year 1914 were reported as \$570,000 on sales amounting to \$2,400,000. The company has outstanding \$733,500 common stock, and \$310,000 of 7 per cent. cumulative preferred, and has a surplus of \$180,000. Indications, according to the report, are for a large increase in sales during 1915. The following officers were elected: President and general manager, H. L. McClaren; vice-president and treasurer, Stuart Webster; secretary and general sales manager, H. C. Severance.

MORE EIGHT-CYLINDER MOTORS ANNOUNCED

A veritable craze for 8-cylinder motors appears to have struck the public, if one would judge from the avalanche of 8-cylinder cars already announced and known to be "in the works." No less than fourteen were shown at the Chicago Automobile Show and several more manufacturers of motors have announced their intention of entering the field. There are grave doubts in the minds of many people in the industry whether or not this 8-cylinder "craze" will last. The ignition difficulties, especially in case of an interruption of current to the spark plugs, require expert diagnosis when befalling a complicated 8-cylinder machine with its multiplication of wiring.

TO FILL AUTOMOBILE WHEELS

First mark the channel and rim the same as a carriage wheel, then take out the hub bolts and take the hub apart. Clean off all grease. Then draw a diagram of the hub, getting a circle of the flange and inner hub. Then make a pattern for the spokes. Shape all spokes but two. Make the tenons on the spoke, drive the spokes on to the rim and then fit up the two blank spokes. Cut out enough of the rim for the draw and leave the wheel 3/16 inch larger than the channel. In setting the channel use the oven to heat it, laying the channel on the wheel rack and driving the wheel into the channel. Use a good grade of glue when putting wheels together.

GRAMM-BERNSTEIN REFUSES ORDERS

Owing to the fact that the factory is taxed to capacity the Gramm-Bernstein Motor Truck Company, Lima, O., was recently compelled to refuse orders for motor trucks. The company is under contract with district agents to deliver a certain number of trucks monthly and these contracts have to be cared for. As a result an offer of a contract for 200 trucks for the domestic business received from the East had to be refused. Plans have been made for increasing the capacity of the plant but if they carried out it will require about 90 days to complete them.

A LIVELY THERMOID BANQUET

The annual banquet of the Chicago forces of the Thermoid Rubber Co. was given under the direction of Mr. J. E. Duffield, district manager, on the evening of January 28, at the Tip Top Inn, in Chicago. Interest in the occasion was increased by the presence of Mr. D. O. Pohlman, the general sales manager of the company, and of Mr. "Bob" Burman, the "world's speed king." There were about 35 present, including prominent members of the Thermoid staff located in western cities and some of the large users of Thermoid goods.

SWINEHART PLANNING ADDITION

The Swinehart Rubber & Tire Co., Akron, O., is having plans made for a 3-story reinforced concrete and brick addition, 60 by 130 feet, to be built at a cost of \$75,000.

Trade News From Near and Far

NEWS OF THE TRADE

The Milledgeville Buggy & Furniture Company, Milledgeville, Ga., has filed a petition in bankruptcy.

The Smoker Wagon Works, Ft. Wayne, Ind., are looking for a new location. They will probably decide on Goshen, Ind.

The Ames Buggy Co., Owensboro, Ky., is turning out about 1,000 jobs a month, which is about two-thirds of the plant's capacity.

The Carriage Woodstock Co., Owensboro, Ky., is keeping 150 men going day and night in building automobile and buggy bodies.

Geo. H. Schelp, of the Jos. W. Moon Buggy Co., St. Louis, Mo., seriously tore the ligaments of his left hand in a fall on an icy pavement.

The Harper Buggy Co., Columbia City, Ind., has increased its working time by 10 hours per week to take care of increased business.

The Clarksville (Tenn.) Buggy Co., which was badly damaged by fire in December, has a new and more commodious building on Third Street opposite the courthouse.

The Mogul Wagon Co., of Hopkinsville, Ky., which was closed during a portion of the fall, resumed operations during January and is now running nearly full time.

The U. S. Wheel & Tire Co., of Rockton, Mich., will erect a brick and concrete 2½-story structure, to manufacture wheels for automobiles and motor trucks. Frank Denny is the sales manager.

The Hickman (Ky.) Wagon Factory, which is owned and operated by S. L. Dodds, has resumed operations after being idle for several months. This concern sells a large per cent. of its products in the Southern or Cotton States.

A reorganization of the Fostoria Storm Buggy Co., Fostoria, O., was effected recently, when the stockholders met and elected officers. The capitalization was increased \$15,000. Extensive improvements in plant and equipment will be made.

According to a local paper, superintendent Albert Burull, of the Mandt Wagon Works, at Stoughton, Wis., has resigned his position, the resignation to take effect the middle of April. R. N. Halley, at present foreman in the blacksmith department, will, it is said, be his successor.

Maj. W. J. Bass has terminated his connection with the Chattanooga Wagon Co., Chattanooga, Tenn. Mr. Bass was secretary of the wagon company. At a reorganization of the concern recently, the following officers were elected: President, C. F. Milburn; vice-president, F. M. Knapp; secretary-treasurer, J. G. Thomison.

A strike at the plant of the Winona Carriage Company, Winona, Minn., has been ended by the men going back to work at the company's terms of a 10 per cent. reduction in wages and an increase in the working day from eight to ten hours. The men will make a little more money than formerly, but will have to work two hours longer a day.

William D. Miller will retire April 1 from the management of the Dan Miller Buggy Company of Alton, Ill. He retains one-third of the stock and two-thirds has been purchased by Claud Ashlock and Fred Foss, who will manage the company. Mr. Miller will engage in other lines of business. The company was established in 1869 and was incorporated in 1888.

The Ohio Carriage Manufacturing Co., of Columbus, Ohio, which recently took over the plant of the Barndt-Johnson Body and Top Co., has started the manufacture of all kinds of

automobile and motor truck bodies. The company will specialize on the manufacture of bodies for Ford cars. H. C. Phelps is president, and J. E. Walsh, secretary and sales manager.

The Columbus (O.) Chamber of Commerce announces that plans have been practically completed whereby some of the buildings of the Columbus Buggy Company will be remodeled and converted for use of small manufacturing enterprises with power furnished. The new Columbus Buggy Company will use but one of the present plant buildings for its manufacturing of electric vehicles.

The old and well known firm of Joubert & White, Glens Falls, N. Y., is to be dissolved. The business has been in operation since 1864, and the firm enjoyed a widely spread reputation for the famous Glens Falls buckboards and pleasure wagons which were built by the firm. Joubert & White, both young mechanics, started in business together without capital. Mr. Joubert has been dead many years.

The Moline Wagon Co., Moline, Ill., has received another big order from one of the warring European nations and work will be started on the order immediately. It is understood that certain departments at the Wagon company and at Deere Co. plants will be rushed until the order is completed. The order calls for 3,500 wagons which will undoubtedly be used for hauling of supplies for the armies in the field. The wagons will be of heavy construction and equipped with tops.

NEW FIRMS AND INCORPORATIONS

Gco. H. Boos will engage in the vehicle business at Deputy, Ill.

W. H. Songer has opened a retail implement and vehicle store at Bucyrus, O.

Lewis & Dryo have opened a vehicle repository at Lebanon, Ky.

H. Deitrick will engage in the vehicle and implement business at New Bavaria, O.

Noble & Fitz have engaged in the vehicle and implement business at Arcadia, Ind.

It is reported that Web Allison will engage in the implement and vehicle business at Horton, Kan.

Barricklow & Detmer have engaged in the implement, vehicle and hardware business at Rising Sun, Ind.

The Pittsfield Hardware Co. has engaged in the vehicle, hardware and implement business at Pittsfield, Ill.

Louden & Co. have incorporated at Trenton, Ill.; capital \$5,000, to deal in agricultural implements, vehicles, etc.

The Groveland Trading Co. has been incorporated at Groveland, Ga., capital \$2,500, and will handle vehicles, implements, harness, etc.

Will Holly, Diana, Tenn., R. F. D. Brick Church, is erecting a new store building for the purpose of engaging in the vehicle and implement business.

The new store of H. T. Houghton at Luther, Ia., has opened for business with a complete and up to date stock of vehicles and implements. Mr. Houghton formerly was in business at Templeton.

The Fred Wilking Carriage Co., of Marietta, Ohio, has been incorporated with a capital of \$10,000 to manufacture buggies and carriages by Fred Wilking, James Wilking, Albert Wilking, Elizabeth Wilking and John C. Wilhelm.

W. M. McCormick and M. C. Broach, of Rome, Ga., have

organized a company to be known as the American Municipal Motor Co., for the purpose of manufacturing motor trucks of various kinds, with a capital of \$150,000, and will erect a plant.

The Valley Mercantile Co., incorporated at Pharr, Texas, with \$35,000 capital, will handle implements, wagons, harness, hardware and general merchandise. The company is erecting a building at a cost of \$10,000, which it will occupy when completed.

BUSINESS CHANGES

Summers & Carpenter, Spencer, Ind., have sold their vehicle business to Millard Humes, of Fortville, Ind.

Rezabek & Mikulecky have been succeeded in the implement and vehicle business at Wilson, Kan., by S. Mikulecky.

The Deputy Milling Company has succeeded to the implement and vehicle business of Reiley & Black at Deputy, Ind.

Kipps & Charlton have succeeded to the implement and vehicle business of Fagg, Kipps & Charlton at Christiansburg, Va.

Geo. E. Taber has purchased a half interest in the vehicle and implement business of M. C. Marion & Son at Elizabethtown, Ky.

John Durr has retired from the firm of Martin, Davenport & Durr, dealers in buggies and implements, at Harrodsburg, Ky.

Becker, Ballard & Scott succeed Becker, Ballard & Williams in the vehicle, harness and implement business at Bryantsville, Ky.

Charles S. Sapp has purchased the interests of his partners in the implement and vehicle business of Sapp Bros. & Ward at Mt. Vernon, Ohio.

Allen & Streed succeed R. H. Spence in the vehicle business at Fairfield, Ia. Mr. Streed is also in business at Middletown, which he will continue.

Heist & Hill, retailers in vehicles and implements at Wauscon, Ohio, have sold an interest in the business to James Gunn and the firm will be known at Heist, Hill & Gunn.

Mrs. Oswald A. Claus has purchased a half interest in the implement and vehicle business of F. V. Burkhardt at Woodsfield, O. The firm name will be F. V. Burkhardt & Co.

C. W. Dumphy, formerly assistant general agent of the International Harvester Co., Evansville, Ind., has purchased an interest in the T. J. Turley Co., of Owensboro, Ky., well known vehicle and implement dealers.

The Russellville Hardware & Implement Co. has been incorporated at Russellville, Mo., to take over the implement, hardware and vehicle stock of the Scrivner-Smith-Morrow Mercantile Co., dealers in general merchandise.

The Schmidt & Stark Co., of West Bend, Wis., will be formed into a corporation with a capital of \$55,000. This concern started business in 1850, at Young America. Its plant at that place burned out in 1891 and in 1892 the company moved to West Bend.

Maj. W. J. Bass has terminated his connection with the Chattanooga Wagon Co., Chattanooga, Tenn. Mr. Bass was secretary of the wagon company. At a reorganization of the concern recently, the following officers were elected: President, C. F. Milburn; vice-president, F. M. Knapp; secretary-treasurer, J. G. Thomison.

FIRES

A fire causing an estimated total loss of \$110,000, destroyed the plant of the Williamson Wagon Co., Williamson, W. Va., on March 4.

The W. J. Westphal Carriage & Automobile Works sustained a small loss by fire last month. The fire started from a forge and burned lumber stored in the basement and a work bench.

The wagon shop of the Wm. Berg Co., Canal Dover, O., was damaged by fire recently. The floor of the building and machinery was damaged. Prompt work by the fire department kept the fire from reaching the paint shop in the building.

OBITUARY

Peter R. Stouffer, 76 years old, carriage manufacturer and Civil War veteran, died Feb. 23 at Marion, O.

Henry Kaiser, Sr., 75, head of the Kaiser Carriage Company, Kenton, O., died of arterial sclerosis March 3. Mr. Kaiser was born in Germany in 1840. After coming to this country he resided in Cincinnati for several years.

Andrew J. Simpson, 81, veteran carriage maker of Nebraska, died at his home in Omaha, February 13, from injuries suffered in a fall a month before. He was head of the A. J. Simpson & Co., having started in the carriage manufacturing industry in Omaha fifty-six years ago.

Henry Hutsonpiller, pioneer wagon and plow maker of Des Moines and Iowa, died at his home in that city on February 18. He was born in Tennessee in 1826, served in the Mexican war, went to California in the gold rush of 1849, and settled in Des Moines in 1851, when that city was a frontier outpost of civilization.

Wm. J. Byron, 83, president of W. D. Byron & Sons, Inc., tanners at Williamsport, Md., died March 2. Mr. Byron brought up his five sons in the leather business, and they in turn have brought their sons into the business. The father of the late Mr. William D. Byron was also in the leather industry in Roxbury, Mass.

Thomas F. Murphy, aged 86 years, one of the Nashville (Tenn.) pioneer carriage manufacturers, died Feb. 10. He had been at the head of the carriage business which he established here in 1851 continuously until a few years ago, when he was forced to retire on account of failing health. He is survived by one son and a daughter.

Peter Heck, 86, for many years a carriage manufacturer at Dayton, O., died Feb. 13 at the home of his son in that city. He was a native of Prussia, coming to America with his parents when he was six years old. He was actively engaged in the carriage manufacturing business until eight months ago when he was succeeded by his son, Wm. A. Heck. Three children survive him.

Hugh McFarlane, president of the H. M. McFarlane Co., of Chicago, Ill., manufacturers of wagons and automobiles, passed away at his home in that city January 15. Mr. McFarlane was born in Montreal, Canada, in 1835, and went to Chicago in 1866. He was the originator of the Pony Express in the western states which later became a part of the Wells-Fargo Express Co. The deceased is survived by five children.

Capt. S. F. Ford, one of the original promoters of the Owensboro Wagon Company, of Owensboro, Ky., recently died of the infirmities of age at the home of his son-in-law at Owensboro. Mr. Ford was 79 years old. He served four years in the Confederate army, enlisting as a private and retiring as a captain. He was in Shelby's command. For a number of years he was secretary-treasurer of the wagon company.

James F. Upson, 67, one of the proprietors of the South Georgia Buggy Co., Valdosta, Ga., died at the home of his son Clarence, in Atlanta, Ga., on Feb. 10. Mr. Upson was born in Cincinnati, and for many years was in business on Gest Street. About nine years ago he moved to Valdosta, where he established a carriage works. Surviving him are four sons, Clarence, a business man; James F., Jr., and William, who are connected with their father's firm, and Charles H. Upson, a traveling man, of Hartwell.

Wm. M. Benns, of Columbus, O., passed away at his home in that city on February 15 at the ripe old age of eighty-two years.

Death followed a stroke of paralysis which he suffered a week before. Mr. Bennis had been a resident of Columbus for sixty-seven years. He was one of the pioneer carriage builders of Ohio. During the Civil War he and a fellow-carriage maker organized the Peters Bennis Carriage Co., which a number of years later became the Columbus Buggy Co. Mr. Bennis had not been actively engaged in business for the past twenty years. His widow, a son and a daughter survive.

Benj. E. Houser, Sr., a pioneer carriage manufacturer of Dayton, O., died Feb. 10 from a complication of diseases of the heart and liver. He was one of the partners of the firm of Houser & Darst, which conducted a carriage and wagon business on the corner of Third and Williams Streets, where the Mory block is standing now. Later he located his business on West Fourth Street where the Arcade is situated at present. When he retired he took charge of the salesroom of the Kauffman Buggy Company of Miamisburg, and later, of the J. L. Baker Carriage Company works, on West Fifth Street. He leaves his widow, three sons and one daughter, also several grandchildren.

NEW TYPE OF AUTOMOBILE TIRE

A new type of automobile tire is the invention of G. V. Bailard, 26 West Fifty-ninth Street, New York City, to whom basic patents have recently been granted. The inner tube is divided into fifteen separate compartments, at least six of which can be punctured without affecting the tire sufficiently to make it necessary to stop for repairs. The inventor figured that it is impossible to make a tire not inflated with air without a sacrifice of resiliency. Therefore he decided to localize the effect of a puncture. By an ingenious device he is able to inflate the fifteen compartments simultaneously, and by a mechanical device each compartment becomes independent of the others, and if one is punctured the two contiguous segments on each side automatically elongate themselves and fill the space, supplying resiliency to the outer tire.

"I have perfected a device," says the inventor, "by means of which a section of the outer tire can be raised and the inner compartments replaced and inflated one at a time without at any time removing the entire shoe. I recently experimented by putting my tires on a farm wagon loaded with two cords of wood, drove it over the roughest roads, and the test was completely satisfactory."

HORSE SHOW DATES, 1915

- Camden, S. C., March 17-18.
- Brooklyn, N. Y., April 14-17.
- Calgary, Can., April 21-23.
- Durland's, April 20-22.
- Philadelphia Indoor Horse Show, April 22-24.
- National Capitol, Washington, D. C., May 8-13.
- Saddle and Sirloin Club of Ohio State University, May 15.
- Tuxedo, N. Y., June 4-5.
- Devon, Pa., May 27-31.
- Fall River, Mass., June 10.
- Rochester, N. Y., Aug. 31-Sept. 4.
- Detroit, Sept. 6-11.
- Syracuse, N. Y., Sept. 13-18.
- Chicago, Ill., Nov. 27-Dec. 4.

OCCUPATIONS OF BELGIAN REFUGEES

Among the statistics collected by the Central Belgian Refugees' Committee, and published in Everyman's Belgian Supplement, it is noted that among the refugees are 86 coach builders (employees no doubt, since employers in all trades are separately stated at 3,333), 627 engineers' employees, 73 furriers, tanners, and leather workers, 10 locksmiths, 201 machinists, 28 motor car mechanics, and 27 saddlers. The grand total of refugees, classified under occupations, is 23,902.

TWELVE-CYLINDER CARS COMING

Although no definite announcements have been made as yet, and probably will not be made for a few weeks, it is well known that several makers contemplate bringing out a 12-cylinder model next year. The significant hint was given at an automobile dealers' dinner recently, in which it was stated that "if the public demanded a 12-cylinder car" this company was prepared to furnish it. The flexibility obtained with a many-cylindered motor is an inducement to many motorists to put up with many of its drawbacks and complexities. At the present time there is but a single 12-cylinder car made, the racing car of the "Sunbeam," a British make, which took part in the last Decoration Day races at Indianapolis.

INDEX TO ADVERTISERS

Backstay Machine and Leather Co.....	40
Central Mfg. Co.....	40
Columbus Bolt Works.....	4th cover
Correspondence School of Carriage and Motor Carriage Drafting	2
Dowler, Chas. L.....	40
Du Pont Fabrikoid Co.....	3d cover
Eccles, Richard, Co.....	3
Fairfield Rubber Co.....	3
Lawson Co., F. H., The.....	2d cover
Lander Bros. Co.	40
Miller Bros.	40
Mulholland Co., The.....	40
National Spring & Wire Co.....	2d cover
Payne Co., E. Scott.....	40
Pierce, F. O., Co.....	3d cover
Porter, H. K.....	3
Standard Wheel Co.....	4th cover
Standard Oil Cloth Co., Inc., The.....	4
Sheldon Axle and Spring Co.....	39
Sherwin-William Co.	1
Sidney Mfg. Co., The.....	40
Stinson Mfg. Co., The Edward.....	3d cover
Virginia and North Carolina Wheel Co.....	40
Willey Co., C. A.....	2
White-Quehl Mfg. Co.....	40
Wilcox Mfg. Co., D.....	1
West Tire Setter Co.....	2

WANTS

Help and situation wanted advertisements, 1 cent a word; all other advertisements in this department, 5 cents a word; initials and figures count as words. Minimum price, 30 cents for each advertisement.

PATENTS

Patents—H. W. T. Jenner, patent attorney and mechanical expert, 606 F St., Washington, D. C. Established 1883. I make a free examination and report if a patent can be had and exactly what it will cost. Send for circular.

WANTED

Wanted—A salesman to call on the carriage trade in Pennsylvania and Ohio. Do not answer this unless you have had experience and know the trade. Address Box 965, Buffalo, N. Y.

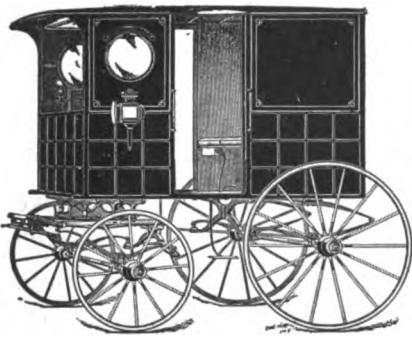

No. 112.—Milk Wagon.

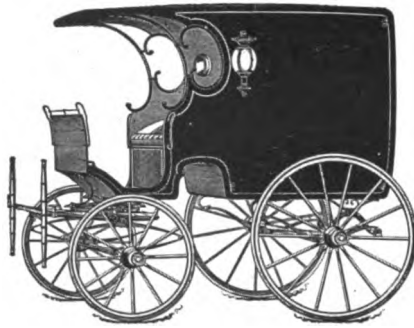

No. 111.—Altman Wagon.



No. 113.—Grocery Wagon.

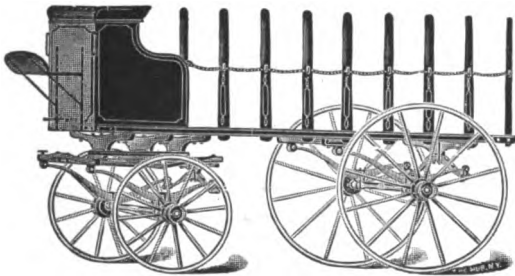

No. 122.—Flour Truck.

Electrotypes
of the vehicles pre-
sented on this page
will be forwarded on
receipt of

75 cts.
for each cut, to any
address. Postage
prepaid.

Catalogue
containing nearly 200
illustrations of carri-
ages, wagons, sleighs,
and miscellaneous
cuts will be sent upon
application.

**Trade News
Publishing Co.**
24-26 MURRAY ST.
NEW YORK

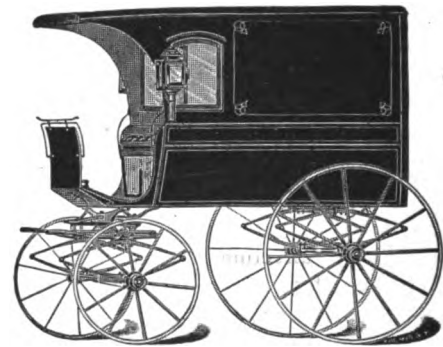

No. 115.—Delivery Wagon.

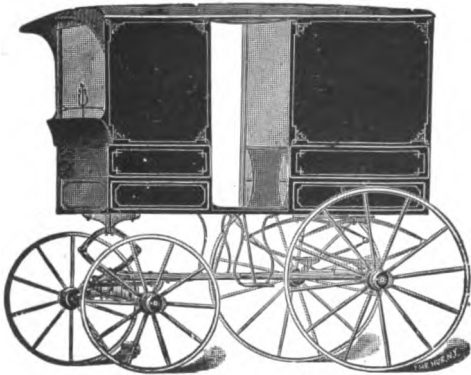

No. 116.—Milk Wagon.

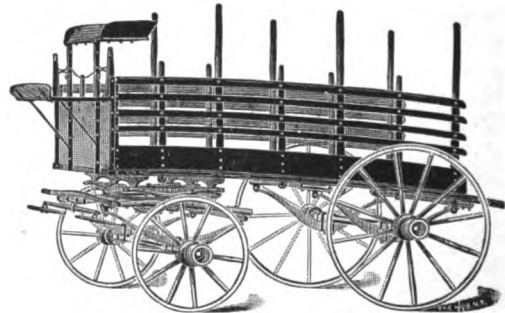

No. 117.—Merchandise Truck.



No. 114.—Delivery Wagon.

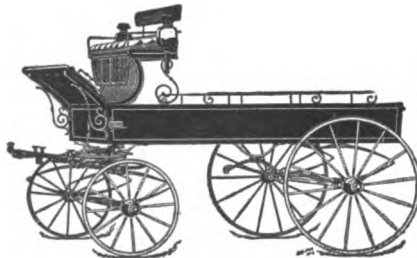

No. 124.—Delivery Wagon.



No. 118.—Ambulance.

SHELDON AXLES AND SPRINGS

For Horse-Drawn and Power-Propelled
Vehicles of All Kinds

JUST ENOUGH BETTER THAN OTHERS TO BE NOTICEABLE

When you specify "Sheldon" you are not experimenting with experiments, but are getting Axles and Springs with years of manufacturing experience back of them—Axles and Springs that are selected for important work where conditions make reliability supremely important

SHELDON AXLE AND SPRING COMPANY, WILKES-BARRE, PA.

LARGEST AXLE AND SPRING FACTORY IN THE WORLD

HOTEL CUMBERLAND

NEW YORK

BROADWAY AT 54TH STREET

Near 50th St. Subway Station
and 53d St. Elevated.

"Broadway" cars from Grand
Central Depot pass the door,
also 7th Avenue cars from
Pennsylvania Station.

New and Fireproof

Best Hotel Accommodations
in New York at Reasonable
Rates.

**\$2.50 with bath
and up**

European Plan

All Hardwood Floors and
Oriental Rugs

Ten minutes' walk to
40 Theatres

Excellent Restaurant
Prices moderate

Send for Booklet



HARRY P. STIMSON, Formerly with Hotel Imperial

Only New York Hotel window-screened throughout

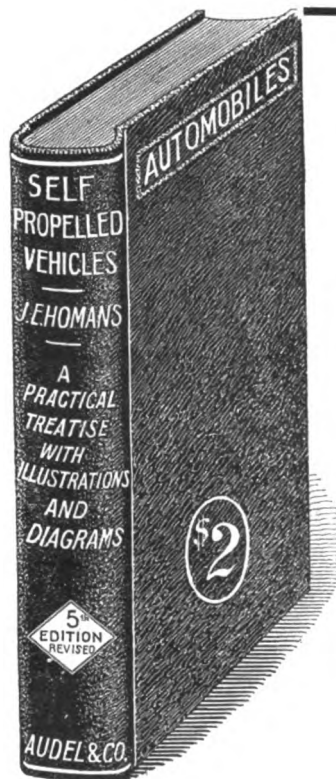

"Self-Propelled Vehicles"

Fifth Edition, Revised.

A practical treatise on the
theory, construction, opera-
tion, care and management of
all kinds of Automobiles.

By

JAMES E. HOMANS, A.M.

Contains 608 pages and
upwards of 500 illustrations
and diagrams, giving the es-
sential details of construction
and many important points
on the successful operation
of the various types of motor
carriages driven by steam,
gasoline and electricity.

This work is now the ac-
cepted standard, explaining
the principles of construction
and operation in a clear and
helpful way. This book will
be sent postpaid to any ad-
dress in the United States,
Mexico or Canada upon re-
ceipt of \$2.00.

Address

Trade News Publishing Co.

24 Murray Street, New York

BUSY BUYERS BRIEFS

CHARLES L. DOWLER
 CARRIAGE AND WAGON HARDWARE
 108 North Third St., Philadelphia, Pa.
CUSHION MANUFACTURER
 Pure Stearic Acid Candles. Wheel Stock. Snow
 Flake Axle Grease.

**Sidney Metal Buggy Seats
 and Metal Bodies**
The Best in the World
Every Seat Guaranteed
THE SIDNEY MANUFACTURING CO., SIDNEY, O.

STEEL SEATS AND BODIES
 Not a Weld, Joint or Seam
GENERAL MANUFACTURING CO.
 CONNERSVILLE, IND.

**MULHOLLAND
 BUGGY SPRING**
 Reduces weight of springs one-half.
 Made in one size only but will fit bodies
 of all widths.
 Write for further particulars and prices.
THE MULHOLLAND CO. DUNKIRK, N. Y.



LINED



UNLINED

White's Brazing Sleeves
 For applying Rubber Tires
 Send for Samples.
WHITE-QUEHL MFG. CO.
 431 E. Pearl St.
 CINCINNATI, OHIO

Buckram, Webbing,
 Mohair, Bow Lining and Strain Straps,
COLORS TO MATCH
 Burlap, Transparent Celluloid, Sheetings
 and Cushion Canvas.
 We Guarantee prompt shipments, best goods, lowest prices.
Lander Bros. Co., Toledo, Ohio

**AUTOMOBILE
 Bodies AND CARRIAGES
 IN THE WHITE**
Estimates Furnished on Special Designs
MILLER BROTHERS
 Amesbury, Mass.

E. SCOTT PAYNE CO.
 Carriage and Automobile
HARDWARE
 Horse - Shoers' Supplies
 362-364 North Gay St., Baltimore, Md.

Subscribe **THE HUB** \$2.00
 Now for Per Year

Finishing Welts
 Bindings
 Auto Straps
 Shaft Straps

**Backstay Machine
 & Leather Co.**
 Union City, Ind.

Patent Valances
 Patent Prop Blocks
 Cut Leather to
 pattern in all grades

BENT RIMS Hickory Second Growth and Forest Hickory
 All Grades
OAK—STAR BRAND

SPOKES Second Growth Hickory—Finished and Club Head
SUITABLE FOR ALL VEHICLES, INCLUDING AUTOMOBILES

VIRGINIA AND NORTH CAROLINA WHEEL CO.
 8 Bridge Street, New York City **RICHMOND, VIRGINIA**

Please mention "The Hub" when you write

"TRIUNE" COLOR VARNISH

Is strictly a Varnish Product possessing color with the power to Cover in one Coat. It works as freely as straight varnish and will "flow," "level," "rub," "moss" and exhibit in general full durable qualities and working properties.

THREE QUALITIES IN ONE PRODUCT

1—Color. 2—Power to cover in one coat. 3—Straight varnish working properties and qualities. Nothing like enamel or gloss paints. Different, distinct.

Sole Manufacturers

F. O. Pierce Company, New York City

12 West Broadway

The Edward Stinson Mfg. Co.

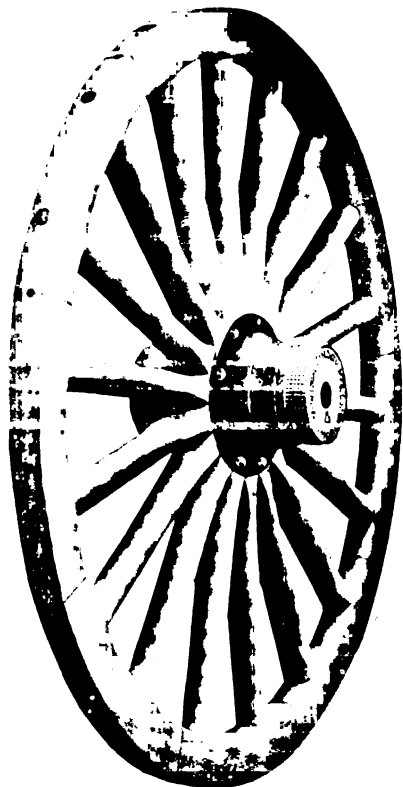

SPOKES, RIM & HUBS

Manufacturers of
Warner, Sarven,
Plain, Compressed
Band and Star or
Kenney Hub

WHEELS

All Sizes

Write for price list
No. 18

327-325 Guilford Ave.
BALTIMORE, MD.

U.S.A.

How Many
Hides
Has
A Cow?

ONE for nature's demands, but several for tanners who split or peel the cow's hide into several thin, fleshy sheets or "Splits," coat them and then emboss one side of each, and call it "Leather." The lower splits are poor apologies for leather and have not the strength and wear-ability of



MOTOR QUALITY

Guaranteed Superior to Coated Splits

coated with the same material as that used on "splits," but re-enforced with a sturdy cloth backing, which adds much to the strength, pliancy and durability of FABRIKOID Motor Quality. Two years' severe tests by leading automobile and carriage makers result in the adoption by them of this superior grade of artificial leather. Our country-wide advertising campaign is telling your trade and prospective buyers the reasons why they should insist on FABRIKOID Motor Quality upholstery in place of inferior coated splits.

Upholster with FABRIKOID Motor Quality,—settle the covering material wisely and finally,—Use FABRIKOID.

For samples and prices, write to Department 269.

DU PONT FABRIKOID CO.

Wilmington, Delaware.

Canadian Branch: Toronto, Ontario.

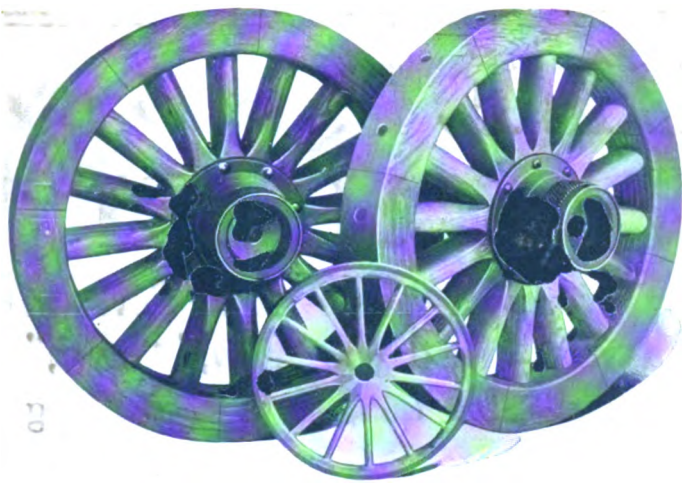

Standard Wheel Co.

Terre Haute, Ind.

Manufacture all kinds and
all sizes of Wheels for
Carriages, Wagons and Motor Vehicles

Quality First

THIS TRADE MARK MEANS MUCH TO VARNISH USERS



It signifies Quality. It is placed
only on the best line of Varnishes
we make---our Gold Cross Line.
We stake our reputation on every
drop that bears this brand. It implies
Faultlessness, and has no superior from Japan
to Finishing Varnish.

Rather strong language—but we can prove it; and we court
comparisons. For years we have been making the most complete line of
Carriage and Auto Varnishes and have put some very intensive study into the
requirements of the trade. A test will convince you of the superiority of the
Gold Cross Brand.

STEWART-MOWRY CO., CHICAGO, ILL.

Skewed Shaft Couplings

**Regular or Oval Patterns
For High Arched Axles**

Furnished in rights and lefts for any height of arch. Oval Axle
Clips $\frac{5}{8}$ or $\frac{3}{4}$ width to match Oval Couplings. Bolts, Clips,
Couplings, Carriage Hardware and Special Forgings

Catalogue "H" and Prices on Application

COLUMBUS BOLT WORKS, Columbus, O.

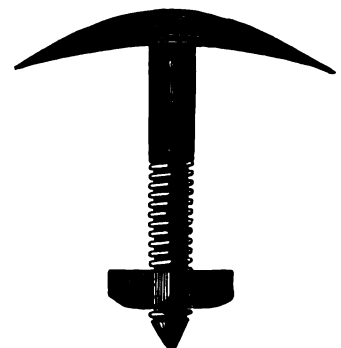
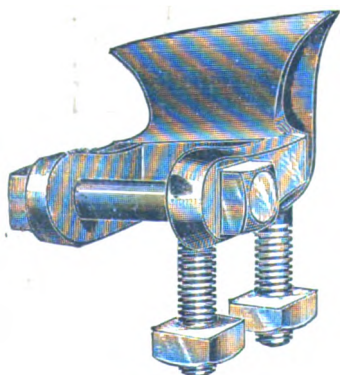

UNIVERSITY OF MICHIGAN

3 9015 08013 4060

